

Product data sheet

Specifications

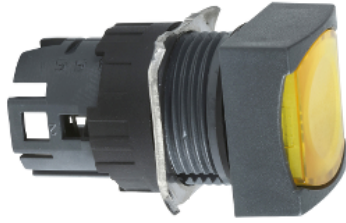

Head for illuminated push button, Harmony XB6, yellow square flush pushbutton Ø 16 latching integral LED

ZB6CF5

Main

Range of Product	Harmony XB6
Product or Component Type	Head for illuminated push-button
Product Compatibility	Integral LED
Device short name	ZB6
Bezel material	Plastic
Mounting diameter	0.63 in (16 mm)
Sale per indivisible quantity	1
Shape of signaling unit head	Square
Type of operator	latching
Operator profile	Yellow flush, unmarked

Complementary

CAD overall width	0.71 in (18 mm)
CAD overall height	0.71 in (18 mm)
CAD overall depth	1.30 in (33 mm)
Net Weight	0.04 lb(US) (0.016 kg)
Resistance to high pressure washer	1015.26 psi (7000000 Pa) 131 °F (55 °C) 0.1 m
Mechanical durability	300000 cycles

Environment

Protective treatment	TC
Ambient Air Temperature for Storage	-40...158 °F (-40...70 °C)
Ambient air temperature for operation	-13...158 °F (-25...70 °C)
Electrical shock protection class	Class II IEC 61140
IP degree of protection	IP65 IEC 60529
NEMA degree of protection	NEMA 13 UL 50 NEMA 4 UL 50 NEMA 4X UL 50

NEMA 13 CSA C22.2 No 94
NEMA 4 CSA C22.2 No 94
NEMA 4X CSA C22.2 No 94

Standards	EN/IEC 60947-5-5 CSA C22.2 No 14 EN/IEC 60947-5-1 JIS C 852 JIS C8201-5-1 EN/IEC 60947-1 UL 508 JIS C8201-1
Product Certifications	UL CSA GOST CCC
Vibration resistance	+/- 3 mm 2...500 Hz)IEC 60068-2-6 5 gn 2...500 Hz)IEC 60068-2-6
Shock resistance	30 gn 18 ms) half sine wave acceleration IEC 60068-2-27 50 gn 11 ms) half sine wave acceleration IEC 60068-2-27

Ordering and shipping details

Category	22459-PUSHBUTTONS, 16MM
Discount Schedule	CS2
GTIN	3389110776249
Returnability	No
Country of origin	ES

Packing Units

Unit Type of Package 1	PCE
Number of Units in Package 1	1
Package 1 Height	0.98 in (2.5 cm)
Package 1 Width	1.18 in (3.0 cm)
Package 1 Length	1.97 in (5.0 cm)
Package 1 Weight	0.28 oz (8.0 g)
Unit Type of Package 2	S01
Number of Units in Package 2	60
Package 2 Height	5.91 in (15 cm)
Package 2 Width	5.91 in (15 cm)
Package 2 Length	15.75 in (40 cm)
Package 2 Weight	24.87 oz (705 g)

Offer Sustainability

Sustainable offer status	Green Premium product
California proposition 65	WARNING: This product can expose you to chemicals including: Di-isodecyl phthalate (DIDP), which is known to the State of California to cause birth defects or other reproductive harm. For more information go to www.P65Warnings.ca.gov
REACH Regulation	REACH Declaration
REACH free of SVHC	Yes
EU RoHS Directive	Pro-active compliance (Product out of EU RoHS legal scope) EU RoHS Declaration
Toxic heavy metal free	Yes
Mercury free	Yes
China RoHS Regulation	China RoHS declaration

RoHS exemption information	Yes
Environmental Disclosure	Product Environmental Profile
Circularity Profile	End of Life Information

Contractual warranty

Warranty	18 months
----------	-----------

Square Head for Illuminated or Non Illuminated Pushbutton

Dimensions

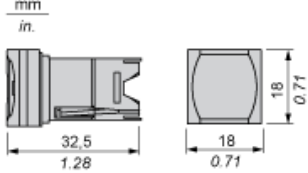

Panel Cut-out

For Square or Circular Head

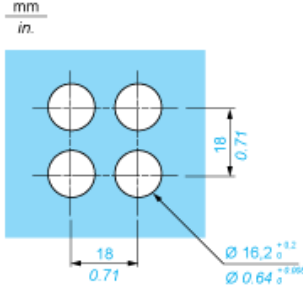

Pushbuttons, Switches and Pilot Lights for Printed Circuit Board Connection

Front Panel Cut-out (Viewed from Installer's Side)

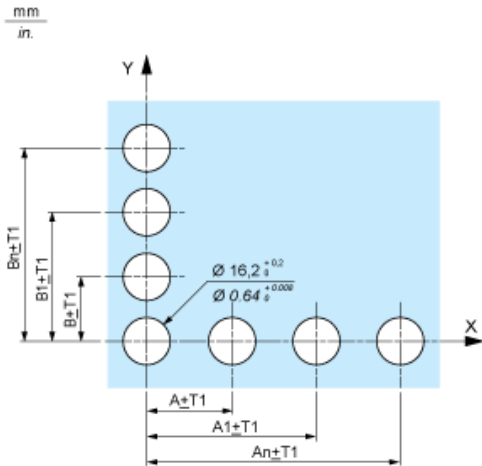

Printed Circuit Board Drillings (Viewed from Electrical Block Side)

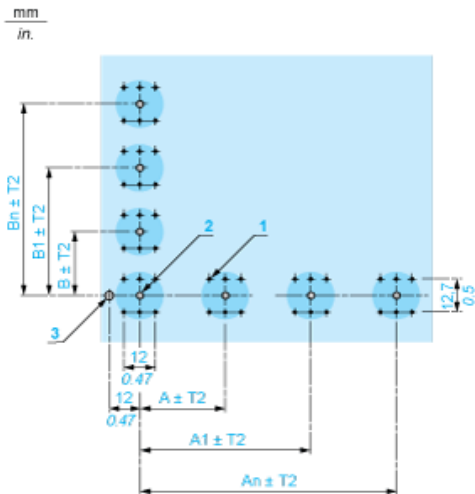

A 24 mm/0.94 in. minimum for rectangular heads, 18 mm/0.71 in. minimum for square or circular heads

B 18 mm/0.71 in. minimum

(1) 6 x Ø 1.1 mm / 6 x Ø 0.04 in. holes.

(2) 1 x Ø 2.6⁰_{-0.2} mm / 1 x Ø 0.10⁰_{-0.008} in. hole for locating pin, only when using socket adaptor ZB6Y010.

(3) 1 x Ø 3.2⁰_{-0.2} mm / 1 x Ø 0.13⁰_{-0.008} in. hole for fixing of printed circuit board onto the front panel using body bracket ZB6Y011. This hole must be

General tolerances of the panel and printed circuit board: T1, T2: T1 + T2 = 0.3 mm/0.01 in. maximum.

Installation precautions:

Thickness of printed circuit board: 1.6 mm/0.06 in. minimum.

Mounting with Body Bracket

With socket adaptor ZB6Y010

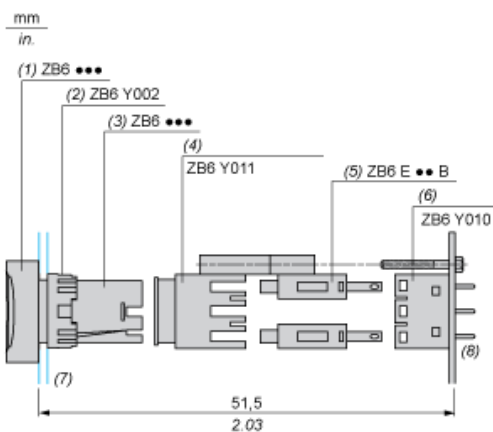

- (1)** Head
- (2)** Nut
- (3)** Body
- (4)** Body bracket
- (5)** Contact block
- (6)** Socket adaptor
- (7)** Panel
- (8)** Printed circuit

Direct mounting without socket adaptor ZB6Y010

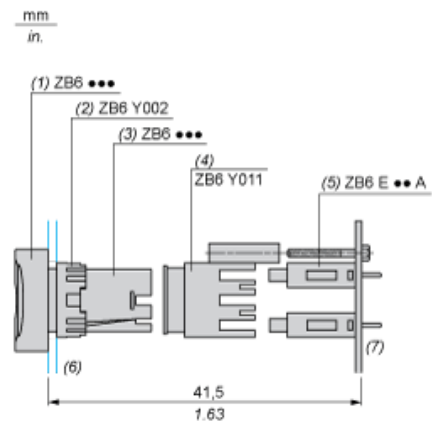

- (1) Head
- (2) Nut
- (3) Body
- (4) Body bracket
- (5) Contact block
- (6) Panel
- (7) Printed circuit