

# Product datasheet

Specifications



## KEY SWITCH

Local distributor code: 237091536 ZB4BG3

EAN Code : 3389110889277

### Main

Range of product	Harmony XB4
Product or component type	Head for key selector switch
Device short name	ZB4
Bezel material	Chromium plated metal
Mounting diameter	22 mm
Head type	Standard
Sale per indivisible quantity	1
Shape of signaling unit head	Round
Operator profile	Black key switch
Operator position information	3 positions +/- 45°
Type of keylock	Key 455
Key withdrawal position	Center

### Complementary

CAD overall width	29 mm
CAD overall height	29 mm
CAD overall depth	72 mm
Net weight	0.098 kg
Resistance to high pressure washer	7000000 Pa at 55 °C, distance : 0.1 m
Mechanical durability	1000000 cycles
Electrical composition code	C3 for <6 contacts using single blocks in front mounting C4 for <6 contacts using single and double blocks in front mounting C5 for <5 contacts using single blocks in front mounting C6 for <5 contacts using single and double blocks in front mounting C7 for <4 contacts using single blocks in front mounting C8 for <4 contacts using single and double blocks in front mounting C11 for <3 contacts using single blocks in front mounting
Device presentation	Basic element

### Environment

Protective treatment	TH
Ambient air temperature for storage	-40...70 °C

<b>Ambient air temperature for operation</b>	-40...70 °C
<b>Overvoltage category</b>	Class I conforming to IEC 60536
<b>IP degree of protection</b>	IP66 conforming to IEC 60529 IP67 IP69 IP69K
<b>NEMA degree of protection</b>	NEMA 13 NEMA 4X
<b>IK degree of protection</b>	IK06 with keyhole cover ZBGP conforming to IEC 50102
<b>Standards</b>	EN/IEC 60947-5-5 CSA C22.2 No 14 UL 508 GB 14048.5 EN/IEC 60947-5-1 EN/IEC 60947-5-4 EN/IEC 60947-1
<b>Product certifications</b>	LROS (Lloyds register of shipping) GL UL listed BV DNV CSA
<b>Vibration resistance</b>	5 gn (f= 2...500 Hz) conforming to IEC 60068-2-6
<b>Shock resistance</b>	30 gn (duration = 18 ms) for half sine wave acceleration conforming to IEC 60068-2-27 50 gn (duration = 11 ms) for half sine wave acceleration conforming to IEC 60068-2-27

## Packing Units

<b>Unit Type of Package 1</b>	PCE
<b>Number of Units in Package 1</b>	1
<b>Package 1 Height</b>	4.000 cm
<b>Package 1 Width</b>	5.400 cm
<b>Package 1 Length</b>	9.200 cm
<b>Package 1 Weight</b>	103.000 g
<b>Unit Type of Package 2</b>	BB1
<b>Number of Units in Package 2</b>	5
<b>Package 2 Height</b>	8.600 cm
<b>Package 2 Width</b>	26.000 cm
<b>Package 2 Length</b>	3.300 cm
<b>Package 2 Weight</b>	515.000 g
<b>Unit Type of Package 3</b>	S03
<b>Number of Units in Package 3</b>	100
<b>Package 3 Height</b>	30.000 cm
<b>Package 3 Width</b>	30.000 cm
<b>Package 3 Length</b>	40.000 cm
<b>Package 3 Weight</b>	10.892 kg

## Offer Sustainability

<b>Sustainable offer status</b>	Green Premium product
<b>REACH Regulation</b>	<a href="#">REACH Declaration</a>
<b>EU RoHS Directive</b>	Pro-active compliance (Product out of EU RoHS legal scope) <a href="#">EU RoHS Declaration</a>
<b>Mercury free</b>	Yes

---

<b>China RoHS Regulation</b>	<a href="#">China RoHS declaration</a>
<b>RoHS exemption information</b>	<a href="#">Yes</a>
<b>Environmental Disclosure</b>	<a href="#">Product Environmental Profile</a>
<b>Circularity Profile</b>	<a href="#">End of Life Information</a>

---

## **Contractual warranty**

---

<b>Warranty</b>	18 months
-----------------	-----------

Dimensions

---

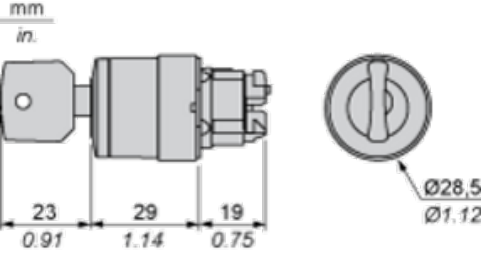

**Panel Cut-out for Pushbuttons, Switches and Pilot Lights (Finished Holes, Ready for Installation)**

Connection by Screw Clamp Terminals or Plug-in Connectors or on Printed Circuit Board	Connection by Faston Connectors
	
<p>(1) Diameter on finished panel or support                  (2) 40 mm min. / 1.57 in. min.                  (3) 30 mm min. / 1.18 in. min.                  (4) Ø 22.5 mm / 0.89 in. recommended (Ø 22.3 mm <sup>+0.4</sup> / 0.88 in. <sup>+0.016</sup>)                  (5) 45 mm min. / 1.78 in. min.                  (6) 32 mm min. / 1.26 in. min.</p>	

**Pushbuttons, Switches and Pilot Lights for Printed Circuit Board Connection**

**Panel Cut-outs (Viewed from Installer's Side)**



A: 30 mm min. / 1.18 in. min.

B: 40 mm min. / 1.57 in. min.

**Printed Circuit Board Cut-outs (Viewed from Electrical Block Side)**

Dimensions in mm

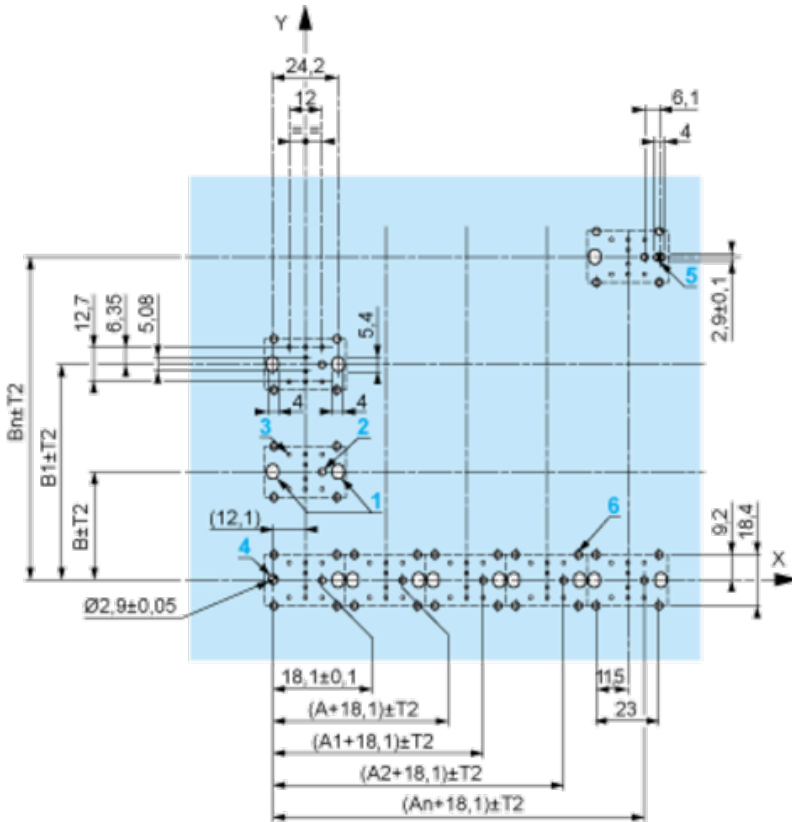

A: 30 mm min.

B: 40 mm min.

Dimensions in in.

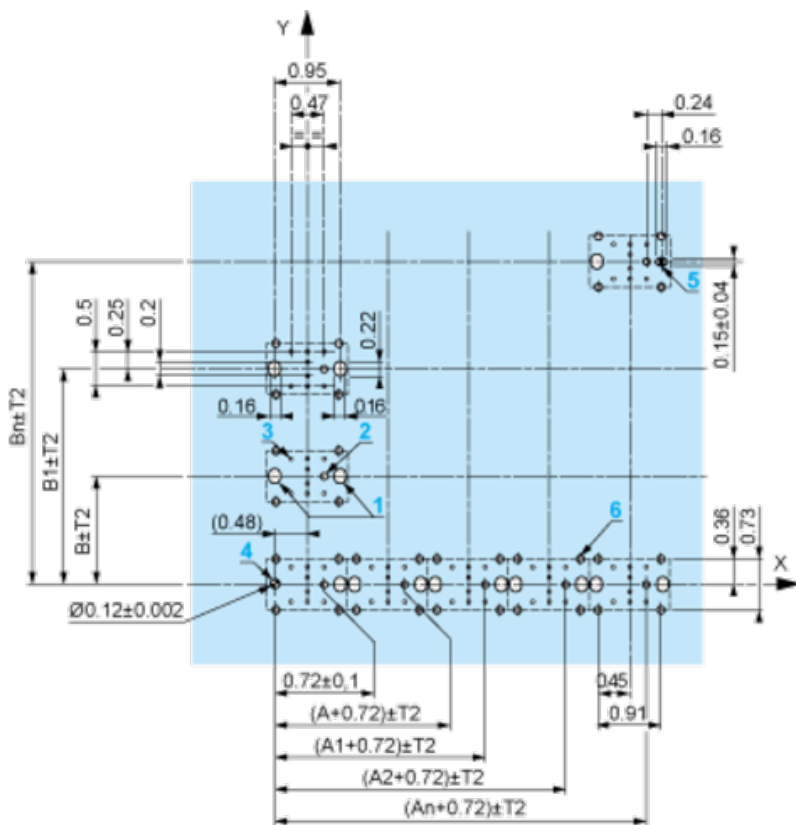

A: 1.18 in. min.

B: 1.57 in. min.

### General Tolerances of the Panel and Printed Circuit Board

The cumulative tolerance must not exceed 0.3 mm / 0.012 in:  $T1 + T2 = 0.3 \text{ mm max.}$

### Installation Precautions

- Minimum thickness of circuit board: 1.6 mm / 0.06 in.
- Cut-out diameter: 22.4 mm  $\pm$  0.1 / 0.88 in.  $\pm$  0.004
- Orientation of body/fixing collar ZB4 BZ009:  $\pm 2^\circ 30'$  (excluding cut-outs marked a and b).
- Tightening torque of screws ZBZ 006: 0.6 N.m (5.3 lbf.in) max.
- Allow for one ZB4 BZ079 fixing collar/pillar and its fixing screws:
  - every 90 mm / 3.54 in. horizontally (X), and 120 mm / 4.72 in. vertically (Y).
  - with each selector switch head (ZB4 BD•, ZB4 BJ•, ZB4 BG•).

The fixing centers marked a and b are diagonally opposed and must align with those marked 4 and 5.



(1) Panel

(2) Printed circuit board

### Mounting of Adapter (Socket) ZBZ 01•

- 1 2 elongated holes for ZBZ 006 screw access
- 2 1 hole  $\varnothing$  2.4 mm  $\pm$  0.05 / 0.09 in.  $\pm$  0.002 for centring adapter ZBZ 01•
- 3 8  $\times$   $\varnothing$  1.2 mm / 0.05 in. holes
- 4 1 hole  $\varnothing$  2.9 mm  $\pm$  0.05 / 0.11 in.  $\pm$  0.002, for aligning the printed circuit board (with cut-out marked a)
- 5 1 elongated hole for aligning the printed circuit board (with cut-out marked b)
- 6 4 holes  $\varnothing$  2.4 mm / 0.09 in. for clipping in adapter ZBZ 01•

Dimensions An + 18.1 relate to the  $\varnothing 2.4 \text{ mm} \pm 0.05 / 0.09 \text{ in.} \pm 0.002$  holes for centring adapter ZBZ 01•.



**Electrical Composition Corresponding to Code C3**

---

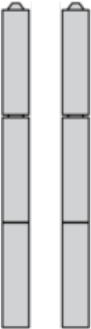

**Electrical Composition Corresponding to Code C4**

---



**Electrical Composition Corresponding to Code C5**

---

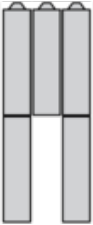

**Electrical Composition Corresponding to Code C6**

---



**Electrical Composition Corresponding to Code C7**

---

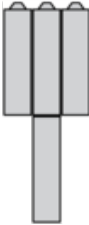

**Electrical Composition Corresponding to Code C8**

---



**Electrical Composition Corresponding to Codes C9, C11, SF1 and SR1**

---



**Legend**

---

Single contact



Double contact



Light block



Possible location





**Sequence of Contacts Fitted to 3-position Selector Switch Body**

**Position 315°**



<b>Push</b>	Position	Top			
		Bottom			
	Location		Left	Centre	Right
	State		1	1	0
<b>Contacts</b>	N/O		closed	closed	open
	N/C		open	open	closed

**Position 0°**



<b>Push</b>	Position	Top			
		Bottom			
	Location		Left	Centre	Right
	State		0	0	0
<b>Contacts</b>	N/O		open	open	open
	N/C		closed	closed	closed

**Position 45°**



<b>Push</b>	Position	Top			
		Bottom			
	Location		Left	Centre	Right
	State		0	1	1
<b>Contacts</b>	N/O		open	closed	closed
	N/C		closed	open	open

Dimensions

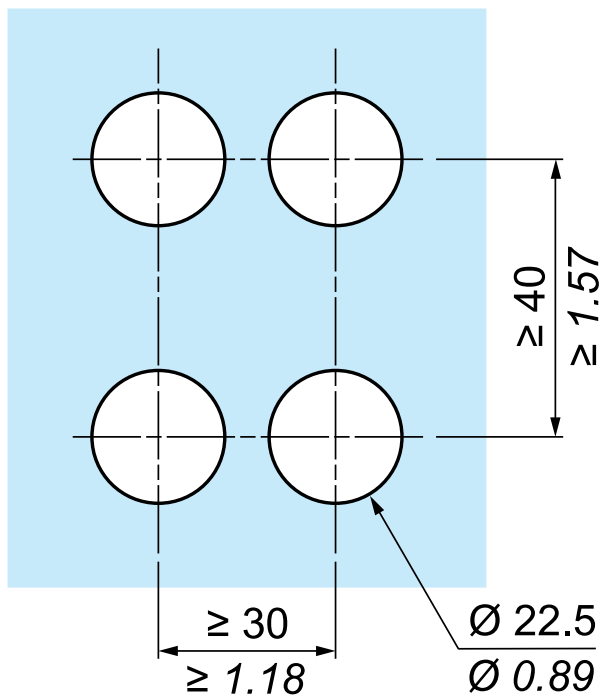
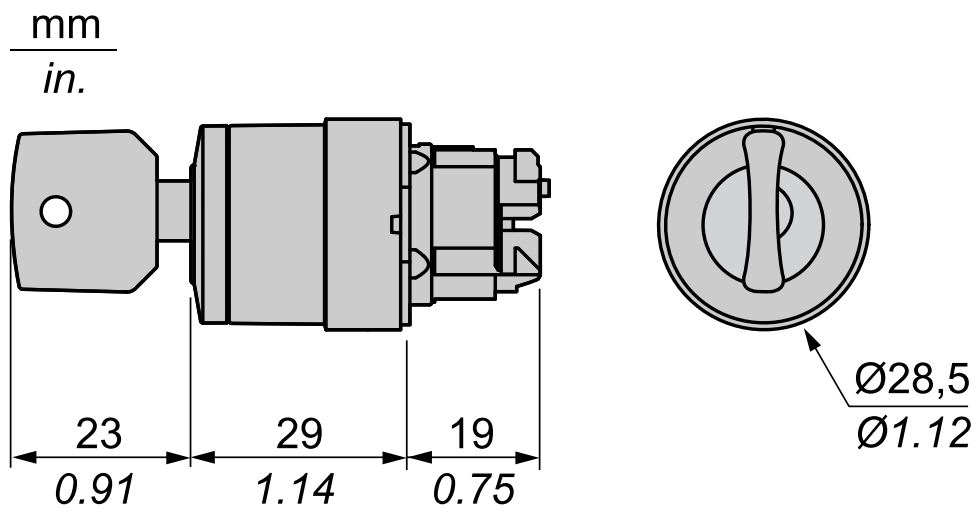

Recommended replacement(s)