

Product data sheet

Specifications



Miniature plug in relay, Harmony, 6A, 4CO, with LED, lockable test button, 24V DC

RXM4AB2BD

Main

Range of product	Harmony Electromechanical Relays
Series name	Miniature
Product or component type	Plug-in relay
Device short name	RXM
Contacts type and composition	4 C/O
[Uc] control circuit voltage	24 V DC
Status LED	With
Control type	Lockable test button
Utilisation coefficient	20 %

Complementary

Shape of pin	Flat
[Ui] rated insulation voltage	250 V conforming to IEC 300 V conforming to CSA 300 V conforming to UL
[Uimp] rated impulse withstand voltage	2.5 kV during 1.2/50 μ s
Contacts material	AgNi
[Ie] rated operational current	3 A at 28 V (DC) NC conforming to IEC 3 A at 250 V (AC) NC conforming to IEC 6 A at 28 V (DC) NO conforming to IEC 6 A at 250 V (AC) NO conforming to IEC 6 A at 277 V (AC) conforming to UL 8 A at 30 V (DC) conforming to UL
Continuous output current	5 A
Maximum switching voltage	250 V conforming to IEC
Resistive rated load	6 A at 250 V AC 6 A at 28 V DC
Maximum switching capacity	1500 VA/168 W
Minimum switching capacity	170 mW at 10 mA, 17 V
Operating rate	\leq 1200 cycles/hour under load \leq 18000 cycles/hour no-load
Mechanical durability	10000000 cycles
Electrical durability	100000 cycles for resistive load

Average coil consumption	0.9 W
Drop-out voltage threshold	$\geq 0.1 U_c$
Operate time	20 ms
Release time	20 ms
Average coil resistance	650 Ohm at 20 °C +/- 10 %
Rated operational voltage limits	19.2...26.4 V DC
Safety reliability data	B10d = 100000
Protection category	RT I
Test levels	Level A group mounting
Operating position	Any position
CAD overall height	82.8 mm
CAD overall depth	80.35 mm
Net weight	0.037 kg
Device presentation	Complete product

Environment

Dielectric strength	1300 V AC between contacts with micro disconnection 2000 V AC between coil and contact with basic insulation 2000 V AC between poles with basic insulation
Product certifications	UL CSA GOST CE Lloyd's
Standards	EN/IEC 61810-1 UL 508 CSA C22.2 No 14
Ambient air temperature for storage	-40...85 °C
Ambient air temperature for operation	-40...55 °C
Vibration resistance	3 gn, amplitude = +/- 1 mm (f = 10...150 Hz)5 cycles in operation 5 gn, amplitude = +/- 1 mm (f = 10...150 Hz)5 cycles not operating
IP degree of protection	IP40 conforming to EN/IEC 60529
Shock resistance	10 gn for in operation 30 gn for not operating
Pollution degree	2

Packing Units

Unit Type of Package 1	PCE
Number of Units in Package 1	1
Package 1 Height	2.0 cm
Package 1 Width	2.8 cm
Package 1 Length	4.8 cm
Package 1 Weight	36.0 g
Unit Type of Package 2	BB1
Number of Units in Package 2	10
Package 2 Height	3.0 cm
Package 2 Width	10.0 cm
Package 2 Length	12.5 cm

Package 2 Weight	400.0 g
Unit Type of Package 3	S02
Number of Units in Package 3	240
Package 3 Height	15.0 cm
Package 3 Width	30.0 cm
Package 3 Length	40.0 cm
Package 3 Weight	10.109 kg

Offer Sustainability

Sustainable offer status	Green Premium product
REACH Regulation	REACH Declaration
REACH free of SVHC	Yes
EU RoHS Directive	Pro-active compliance (Product out of EU RoHS legal scope) EU RoHS Declaration
Toxic heavy metal free	Yes
Mercury free	Yes
China RoHS Regulation	China RoHS declaration
RoHS exemption information	Yes
Environmental Disclosure	Product Environmental Profile
Circularity Profile	End of Life Information
WEEE	The product must be disposed on European Union markets following specific waste collection and never end up in rubbish bins
California proposition 65	WARNING: This product can expose you to chemicals including: Nickel compounds, which is known to the State of California to cause cancer, and Di-isodecyl phthalate (DIDP), which is known to the State of California to cause birth defects or other reproductive harm. For more information go to www.P65Warnings.ca.gov

Contractual warranty

Warranty	18 months
----------	-----------

Dimensions

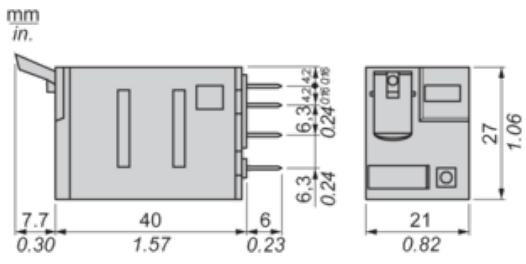

Pin Side View



Wiring Diagram

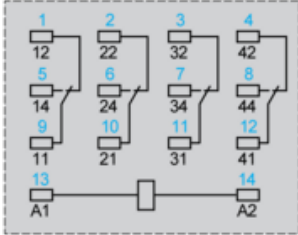
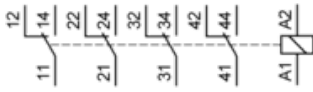

Symbols shown in blue correspond to Nema marking.

Electrical Durability of Contacts

Durability (inductive load) = durability (resistive load) x reduction coefficient.

Resistive AC load

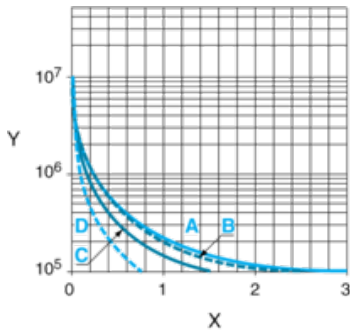

X Switching capacity (kVA)

Y Durability (Number of operating cycles)

A RXM2AB...

B RXM3AB...

C RXM4AB...

D RXM4GB...

Reduction coefficient for inductive AC load (depending on power factor $\cos \phi$)

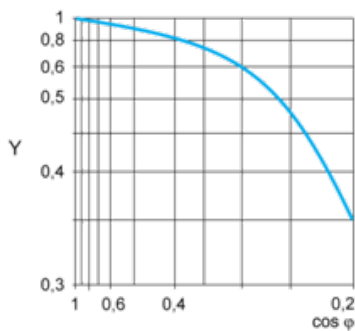

Y Reduction coefficient (A)

Maximum switching capacity on resistive DC load

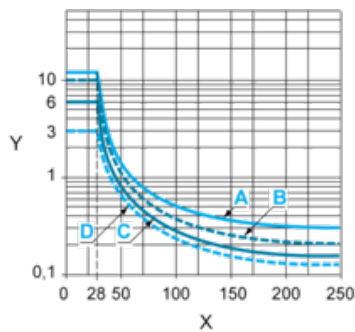

X Voltage DC

Y Current DC

A RXM2AB...

B RXM3AB...

C RXM4AB...

D RXM4GB...

Note : These are typical curves, actual durability depends on load, environment, duty cycle, etc.

Coil Operating Range

DC Coil Operating Range VS Ambient Temperature

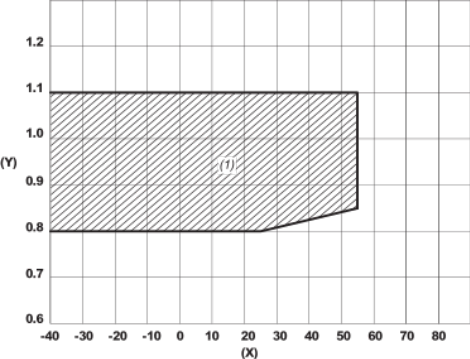

X : Ambient temperature (°C)

Y : AC coil voltage (U/Uc)

(1) Permitted operating range area

Dimensions

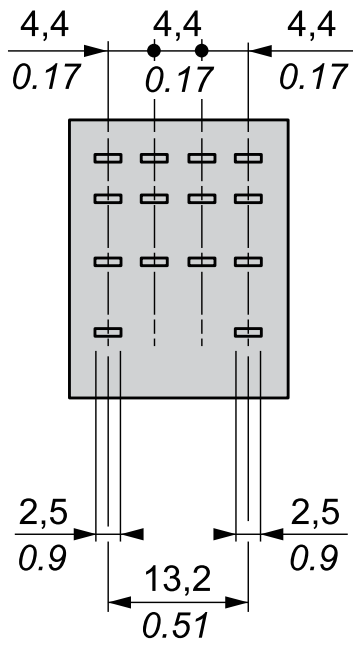
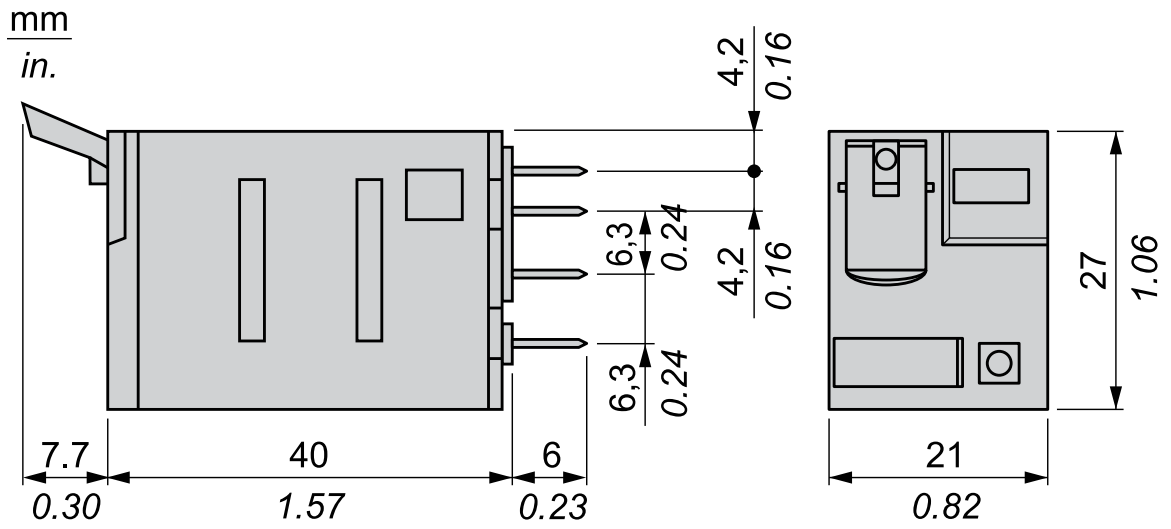

Wiring Diagram

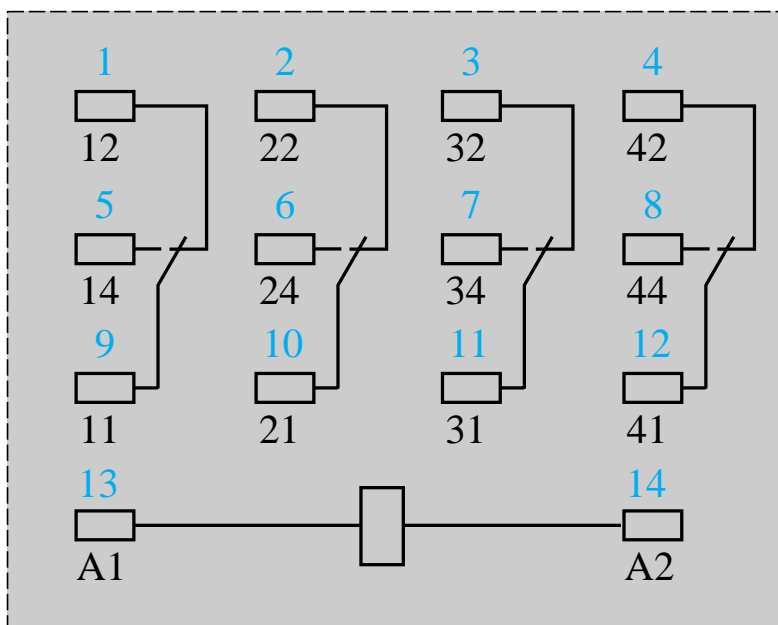
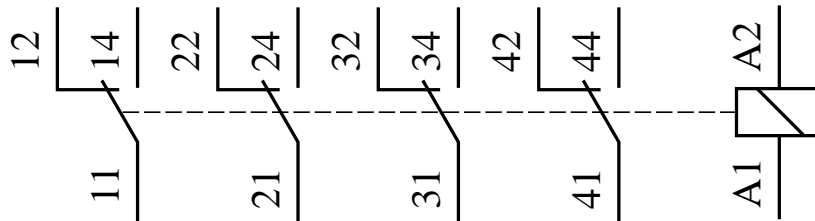

IEC
 NEMA

Recommended replacement(s)