

Product data sheet

Specifications



Harmony, Modular 1-phase voltage control relay, 5 A, 1 CO, 20...80 V AC/DC

RM17UAS16

Main

Range of product	Harmony Control Relays
Product or component type	Voltage control relay
Relay type	Voltage control relay
Product specific application	For single-phase and DC supply
Relay name	RM17UAS
Relay monitored parameters	Overvoltage or undervoltage detection Self-powered
Time delay	Adjustable 0.1...10 s, 0 + 10 % on crossing the threshold
Switching capacity in VA	1250 VA
Minimum switching current	10 mA at 5 V DC
Maximum switching current	5 A AC/DC
Power consumption in VA	0...3.9 VA AC
Measurement range	20...80 V voltage AC 50/60 Hz 20...80 V voltage DC
Utilisation category	AC-12 conforming to IEC 60947-5-1 AC-13 conforming to IEC 60947-5-1 AC-14 conforming to IEC 60947-5-1 AC-15 conforming to IEC 60947-5-1 DC-12 conforming to IEC 60947-5-1 DC-13 conforming to IEC 60947-5-1 DC-14 conforming to IEC 60947-5-1
Contacts type and composition	1 C/O

Complementary

Reset time	1500 ms time delay
Maximum switching voltage	250 V AC/DC
[Us] rated supply voltage	24...48 V AC/DC 50/60 Hz +/- 10 %
Supply voltage limits	15...100 V AC/DC
Maximum power consumption in W	1.6 W DC
Immunity to microbreaks	20 ms
Control circuit frequency	50...60 Hz +/- 10 %
Output contacts	1 C/O
Nominal output current	5 A

Maximum measuring cycle	150 ms measurement cycle as true rms value
Hysteresis	5...20 % of threshold setting
Delay at power up	1000 ms DC 500 ms AC
Measurement accuracy	+/- 10 % of the full scale value
Repeat accuracy	+/- 0.5 % for input and measurement circuit +/- 1 % for time delay
Measurement error	< 1 % over the whole range with voltage variation 0.2 %/°C with temperature variation
Polarity	Non reversible polarity on DC supply
Quality labels	CE
Overvoltage category	III conforming to IEC 60664-1
Insulation resistance	> 500 MOhm at 500 V DC conforming to IEC 60255-5 > 500 MOhm at 500 V DC conforming to IEC 60664-1
[Ui] rated insulation voltage	250 V conforming to IEC 60664-1 400 V conforming to IEC 60664-1
Operating position	Any position without derating
Connections - terminals	Screw terminals, 1 x 0.5...1 x 4 mm ² (AWG 20...AWG 11) solid without cable end Screw terminals, 2 x 0.5...2 x 2.5 mm ² (AWG 20...AWG 14) solid without cable end Screw terminals, 1 x 0.2...2 x 2.5 mm ² (AWG 24...AWG 12) flexible with cable end Screw terminals, 2 x 0.2...2 x 1.5 mm ² (AWG 24...AWG 16) flexible with cable end
Tightening torque	0.6...1 N.m conforming to IEC 60947-1
Housing material	Self-extinguishing plastic
Local signalling	LED (green) for power ON LED (yellow) for relay ON
Mounting support	35 mm symmetrical DIN rail conforming to EN/IEC 60715
Electrical durability	100000 cycles
Mechanical durability	30000000 cycles
Operating rate	<= 360 operations/hour full load
Width	17.5 mm
Net weight	0.08 kg
Compatibility code	RM17

Environment

Electromagnetic compatibility	Emission standard for industrial environments conforming to EN/IEC 61000-6-4 Emission standard for residential, commercial and light-industrial environments conforming to EN/IEC 61000-6-3 Immunity for industrial environments conforming to NF EN/IEC 61000-6-2
Standards	EN/IEC 60255-6
Product certifications	CSA GL UL GOST C-Tick
Directives	73/23/EEC - low voltage directive 89/336/EEC - electromagnetic compatibility
Ambient air temperature for storage	-40...70 °C
Ambient air temperature for operation	-20...50 °C
Relative humidity	95 % at 55 °C conforming to IEC 60068-2-30
Vibration resistance	0.35 mm (f= 5...57.6 Hz) conforming to IEC 60068-2-6 1 gn (f= 57.6...150 Hz) conforming to IEC 60255-21-1
Shock resistance	5 gn conforming to IEC 60068-2-27

IP degree of protection	IP20 (terminals) conforming to IEC 60529 IP30 (casing) conforming to IEC 60529
Pollution degree	3 conforming to IEC 60664-1
Dielectric test voltage	2 kV, 1 min AC 50 Hz conforming to IEC 60255-5 2 kV, 1 min AC 50 Hz conforming to IEC 60664-1
Non-dissipating shock wave	4 kV conforming to IEC 60255-5 4 kV conforming to IEC 60664-1 4 kV conforming to IEC 61000-4-5

Packing Units

Unit Type of Package 1	PCE
Number of Units in Package 1	1
Package 1 Height	2.8 cm
Package 1 Width	7.9 cm
Package 1 Length	9.6 cm
Package 1 Weight	88.0 g
Unit Type of Package 2	S02
Number of Units in Package 2	48
Package 2 Height	15.0 cm
Package 2 Width	30.0 cm
Package 2 Length	40.0 cm
Package 2 Weight	4.664 kg

Offer Sustainability

Sustainable offer status	Green Premium product
REACH Regulation	REACH Declaration
EU RoHS Directive	Pro-active compliance (Product out of EU RoHS legal scope) EU RoHS Declaration
Mercury free	Yes
China RoHS Regulation	China RoHS declaration
RoHS exemption information	Yes
Environmental Disclosure	Product Environmental Profile
Circularity Profile	End of Life Information
WEEE	The product must be disposed on European Union markets following specific waste collection and never end up in rubbish bins
California proposition 65	WARNING: This product can expose you to chemicals including: Lead and lead compounds, which is known to the State of California to cause cancer and birth defects or other reproductive harm. For more information go to www.P65Warnings.ca.gov

Contractual warranty

Warranty	18 months
-----------------	-----------

Single-Phase and DC Voltage Control Relays

Dimensions and Mounting

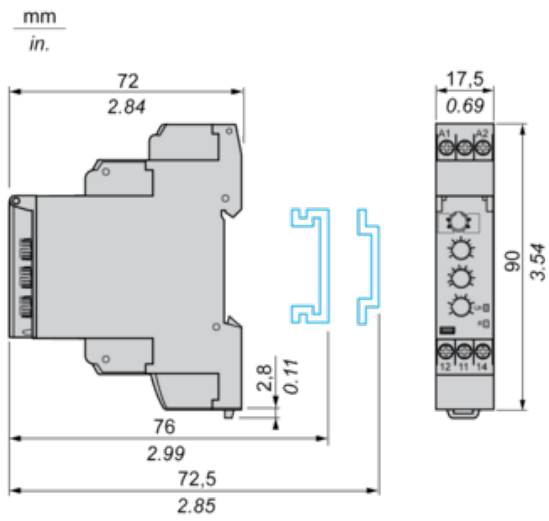

Single-Phase and DC Voltage Control Relays

Wiring Diagram

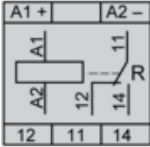

Application Scheme

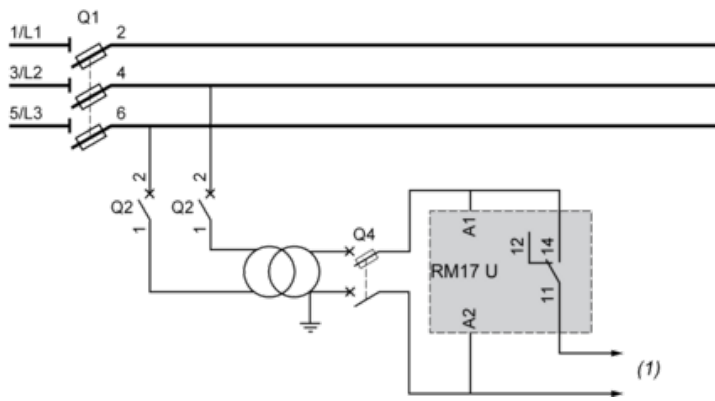

(1) To sensitive loads

Function Diagrams

Undervoltage Control

Without memory ("No Memory" mode)

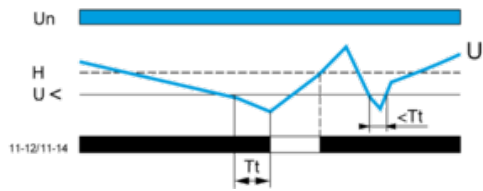

With memory ("Memory" mode)

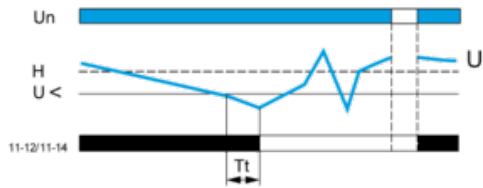

Overvoltage Control

Without memory ("No Memory" mode)

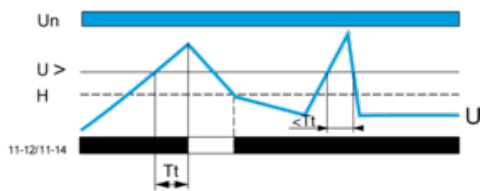

With memory ("Memory" mode)

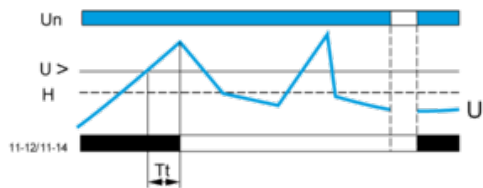

Legend

Tt Time delay after crossing of threshold

Un Nominal supply voltage

U Monitored supply voltage

H Hysteresis

U> Overvoltage threshold

U< Undervoltage threshold

11-12, 11-14 Output relay connections (refer to Connections and Schema)

Relay status: black color = energized.

NOTE: In "Memory" mode, the relay opens when crossing of the threshold is detected and then stays in that position. The power supply voltage must be switched off to reset the product.

Recommended replacement(s)