

# Product data sheet

Specifications



## Motor circuit breaker, TeSys Deca, 3P, 1A, magnetic, rotary handle, screw clamp terminals

GV2L05

### Main

Range	TeSys Deca
Product name	TeSys GV2 TeSys Deca
Product or component type	Motor circuit breaker
Device short name	GV2L
Device application	Motor protection
Trip unit technology	Magnetic

### Complementary

Poles description	3P
Network type	AC
Utilisation category	Category A conforming to IEC 60947-2 AC-3 conforming to IEC 60947-4-1
Network frequency	50/60 Hz conforming to IEC 60947-2
Fixing mode	35 mm symmetrical DIN rail: clipped Panel: screwed (with 2 x M4 screws)
Motor power kW	0.25 kW at 400/415 V AC 50/60 Hz 0.37 kW at 400/415 V AC 50/60 Hz 0.37 kW at 500 V AC 50/60 Hz 0.55 kW at 690 V AC 50/60 Hz 0.75 kW at 690 V AC 50/60 Hz
Breaking capacity	100 kA Icu at 230/240 V AC 50/60 Hz conforming to IEC 60947-2 100 kA Icu at 400/415 V AC 50/60 Hz conforming to IEC 60947-2 100 kA Icu at 440 V AC 50/60 Hz conforming to IEC 60947-2 100 kA Icu at 500 V AC 50/60 Hz conforming to IEC 60947-2 100 kA Icu at 690 V AC 50/60 Hz conforming to IEC 60947-2
[Ics] rated service short-circuit breaking capacity	100 % at 690 V AC 50/60 Hz conforming to IEC 60947-2 100 % at 500 V AC 50/60 Hz conforming to IEC 60947-2 100 % at 230/240 V AC 50/60 Hz conforming to IEC 60947-2 100 % at 440 V AC 50/60 Hz conforming to IEC 60947-2 100 % at 400/415 V AC 50/60 Hz conforming to IEC 60947-2
Control type	Rotary handle
[In] rated current	1 A
Magnetic tripping current	13 A
[I <sub>th</sub> ] conventional free air thermal current	1 A conforming to IEC 60947-4-1
[Ue] rated operational voltage	690 V AC 50/60 Hz conforming to IEC 60947-2
[Ui] rated insulation voltage	690 V AC 50/60 Hz conforming to IEC 60947-2

<b>[Uimp] rated impulse withstand voltage</b>	6 kV conforming to IEC 60947-2
<b>Suitability for isolation</b>	Yes conforming to IEC 60947-1 § 7-1-6
<b>Power dissipation per pole</b>	1.8 W
<b>Mechanical durability</b>	100000 cycles
<b>Electrical durability</b>	100000 cycles for AC-3 at 415 V In
<b>Rated duty</b>	Continuous conforming to IEC 60947-4-1
<b>Tightening torque</b>	1.7 N.m - on screw clamp terminal
<b>Width</b>	45 mm
<b>Height</b>	89 mm
<b>Depth</b>	97 mm
<b>Net weight</b>	0.33 kg
<b>Colour</b>	Dark grey

## Environment

<b>Standards</b>	EN/IEC 60947-2 EN/IEC 60947-4-1 CSA C22.2 No 60947-4-1 UL 60947-4-1
<b>Product certifications</b>	IECEE CB Scheme UL CSA CCC EAC RINA LROS (Lloyds register of shipping) DNV-GL BV UKCA
<b>IK degree of protection</b>	IK04
<b>IP degree of protection</b>	IP20 conforming to IEC 60529
<b>Climatic withstand</b>	conforming to IACS E10
<b>Ambient air temperature for storage</b>	-40...80 °C
<b>Fire resistance</b>	960 °C conforming to IEC 60695-2-11
<b>Ambient air temperature for operation</b>	-20...60 °C
<b>Mechanical robustness</b>	Shocks: 30 Gn for 11 ms Vibrations: 5 Gn, 5...150 Hz
<b>Operating altitude</b>	2000 m

## Packing Units

<b>Unit Type of Package 1</b>	PCE
<b>Number of Units in Package 1</b>	1
<b>Package 1 Height</b>	9.3 cm
<b>Package 1 Width</b>	4.6 cm
<b>Package 1 Length</b>	10 cm
<b>Package 1 Weight</b>	263 g
<b>Unit Type of Package 2</b>	S02
<b>Number of Units in Package 2</b>	20
<b>Package 2 Height</b>	15 cm
<b>Package 2 Width</b>	30 cm

<b>Package 2 Length</b>	40 cm
<b>Package 2 Weight</b>	5.524 kg

## Offer Sustainability

<b>REACH Regulation</b>	<a href="#">REACH Declaration</a>
<b>EU RoHS Directive</b>	Compliant <a href="#">EU RoHS Declaration</a>
<b>Mercury free</b>	Yes
<b>China RoHS Regulation</b>	<a href="#">China RoHS declaration</a> Product out of China RoHS scope. Substance declaration for your information
<b>RoHS exemption information</b>	Yes
<b>WEEE</b>	The product must be disposed on European Union markets following specific waste collection and never end up in rubbish bins
<b>California proposition 65</b>	WARNING: This product can expose you to chemicals including: Antimony oxide & Antimony trioxide, which is known to the State of California to cause cancer. For more information go to <a href="http://www.P65Warnings.ca.gov">www.P65Warnings.ca.gov</a>

## Contractual warranty

<b>Warranty</b>	18 months
-----------------	-----------

**Tripping Curves for GV2L or LE Combined with Thermal Overload Relay LRD or LR2K**  
Average Operating Times at 20 °C Related to Multiples of the Setting Current

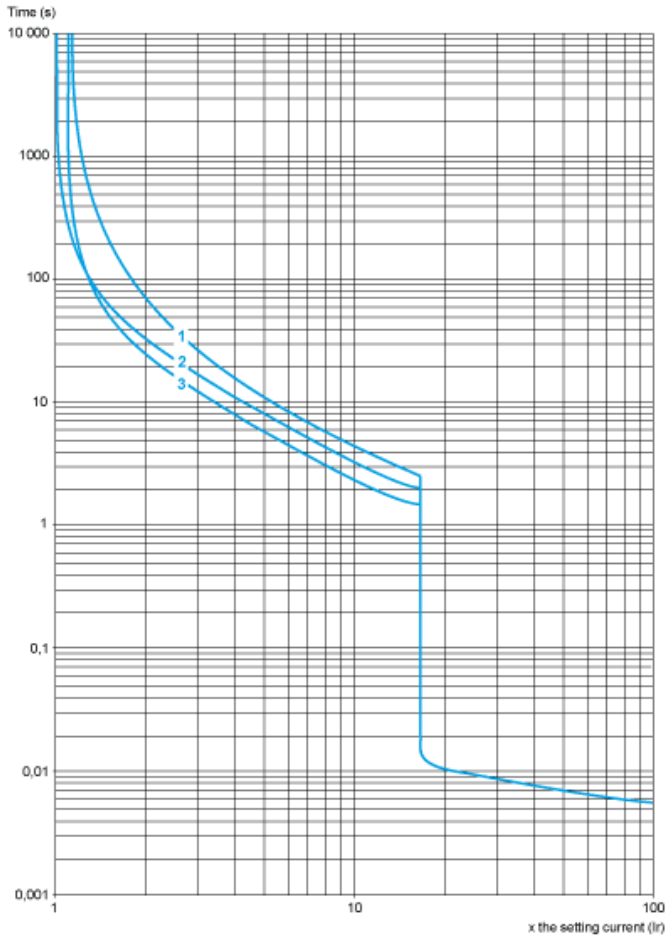

- 1 3 poles from cold state
- 2 2 poles from cold state
- 3 3 poles from hot state

**Current Limitation on Short-Circuit for GV2L and GV2LE Only (3-Phase 400/415 V)**

**Dynamic Stress**

$I_{peak} = f(\text{prospective } I_{sc}) \text{ at } 1.05 U_e = 435 \text{ V}$

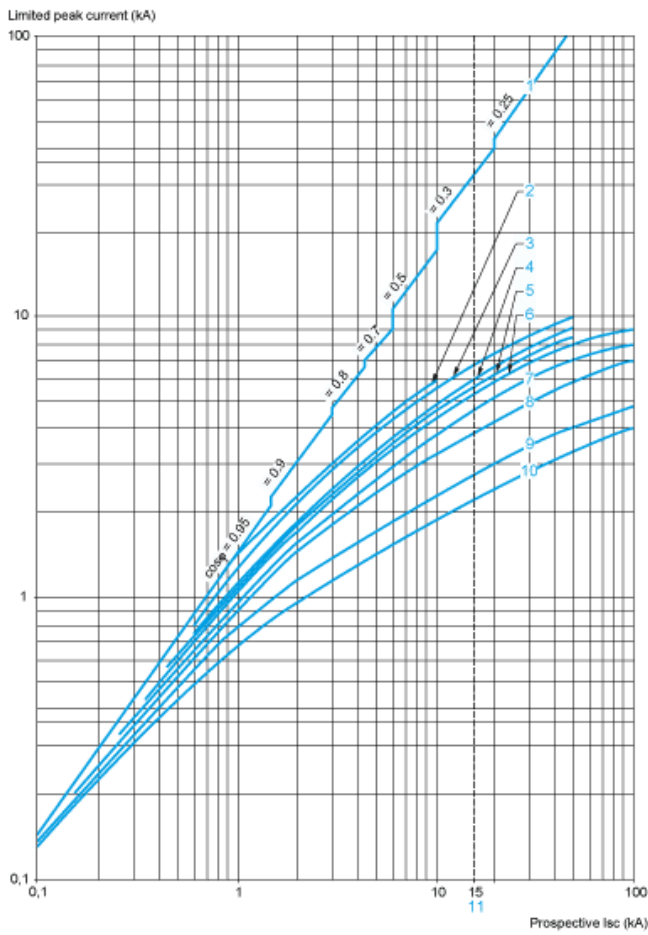

- 1 Maximum peak current
- 2 32 A
- 3 25 A
- 4 18 A
- 5 14 A
- 6 10 A
- 7 6.3 A
- 8 4 A
- 9 2.5 A
- 10 1.6 A
- 11 Limit of rated ultimate breaking capacity on short-circuit of GV2LE (14, 18, 23, and 25 A ratings).

**Current Limitation on Short-Circuit for GV2L and GV2LE + Thermal Overload Relay LRD or LR2K (3-Phase 400/415 V)**

**Dynamic Stress**

$I_{peak} = f(\text{prospective } I_{sc}) \text{ at } 1.05 U_e = 435 \text{ V}$

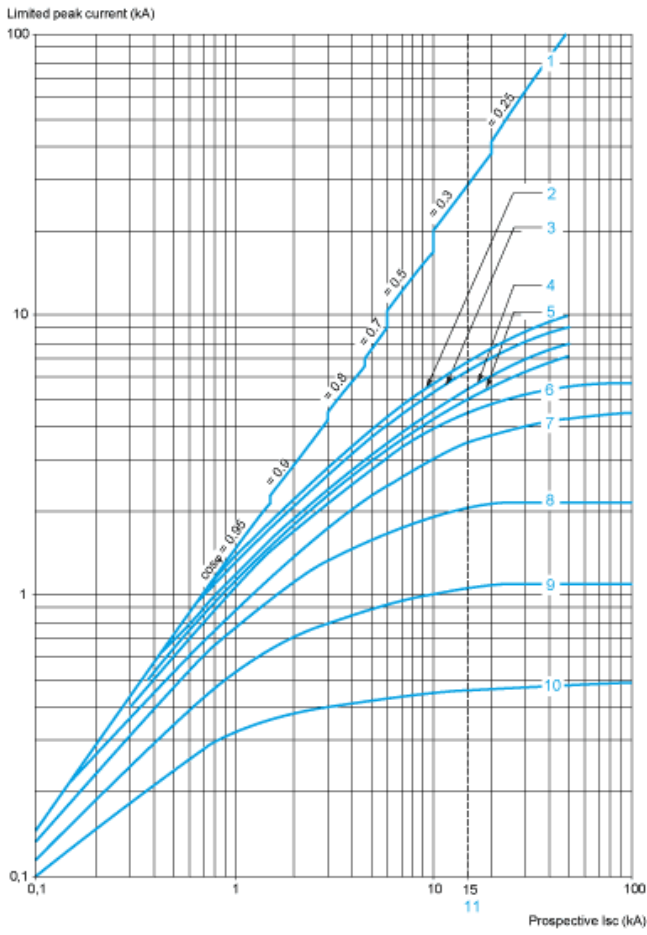

- 1 Maximum peak current
- 2 32 A
- 3 25 A
- 4 18 A
- 5 14 A
- 6 10 A
- 7 6.3 A
- 8 4 A
- 9 2.5 A
- 10 1.6 A
- 11 Limit of rated ultimate breaking capacity on short-circuit of GV2LE (14, 18, 23, and 25 A ratings).

**Thermal Limit on Short-Circuit for GV2L Only**

**Thermal Limit in kA<sup>2</sup>s in the Magnetic Operating Zone**

Sum of I<sup>2</sup>dt = f (prospective Isc) at 1.05 Ue = 435 V

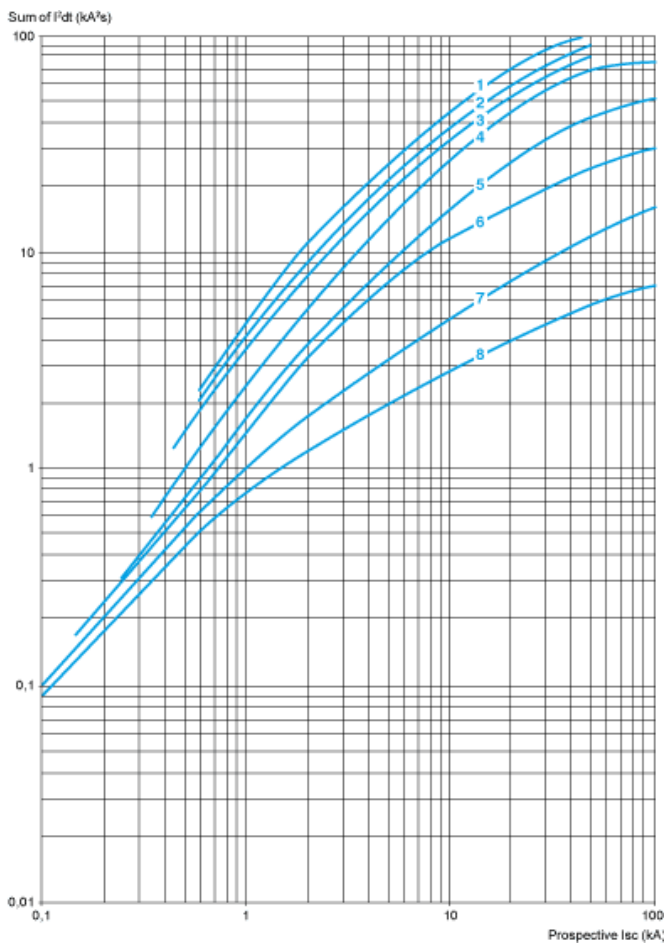

- 1 25 A and 32 A
- 2 18 A
- 3 14 A
- 4 10 A
- 5 6.3 A
- 6 4 A
- 7 2.5 A
- 8 1.6 A

**Thermal Limit on Short-Circuit for GV2L and GV2LE + Thermal Overload Relay LRD or LR2K**

**Thermal Limit in kA<sup>2</sup>s in the Magnetic Operating Zone**

Sum of I<sup>2</sup>dt = f (prospective I<sub>sc</sub>) at 1.05 U<sub>e</sub> = 435 V

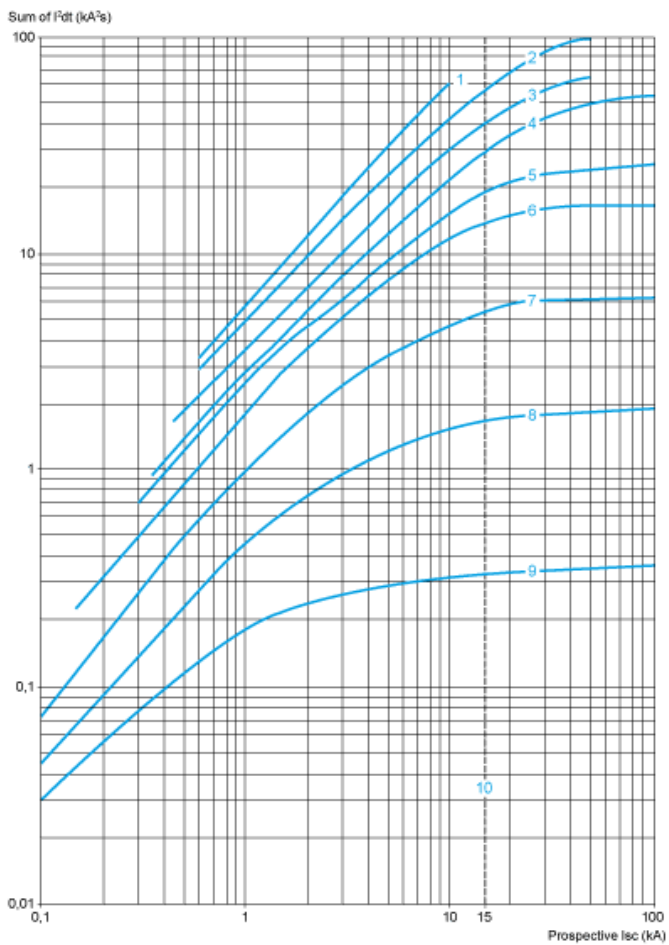

- 1 32 A (GV2LE32)
- 2 25 A and 32 A (GV2L32)
- 3 18 A
- 4 14 A
- 5 10 A
- 6 6.3 A
- 7 4 A
- 8 2.5 A
- 9 1.6 A
- 10 Limit of rated ultimate breaking capacity on short-circuit of GV2 LE (14, 18, 23, and 25 A ratings).



**GV2L**

**Dimensions**

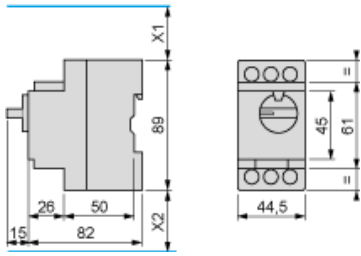

X1 Electrical clearance = 40 mm for  $U_e \leq 415$  V, or 80 mm for  $U_e = 440$  V, or 120 mm for  $U_e = 500$  and 690 V.

X2 = 40 mm.

**GVAD, AM, AN, AU, AS**

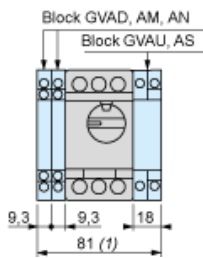

**1** Maximum

**GV2AK00**

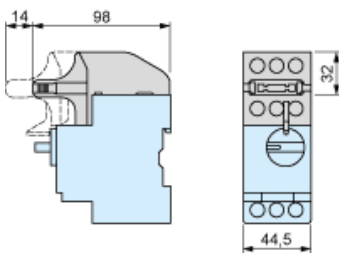

**Mounting**

On rail AM1 DE200, AM1 ED200 (35 x 15)

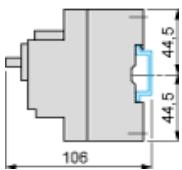

Panel mounted

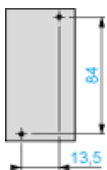

On pre-slotted mounting plate AM1 PA

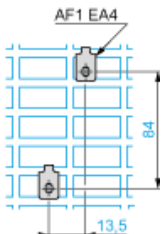

**Adapter Plate GK2AF01**

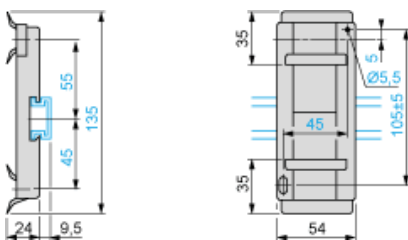

**7.5 mm Height Compensation Plate GV1F03**

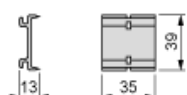

## Mounting

### Mounting of External Operator GV2APN01, GV2APN02 or GV2APN04 for Motor Circuit Breakers GV2L

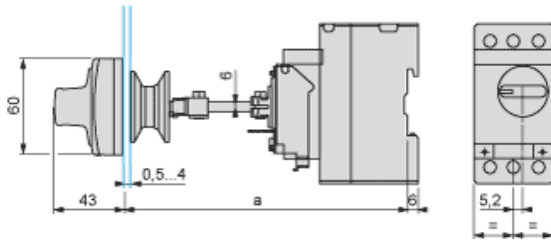

#### Door cut-out

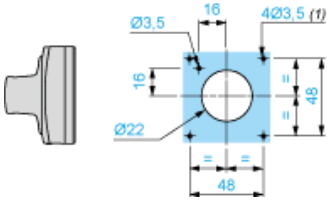

(1) For IP65 only.

### Mounting of External Operator GVAPH02 for Motor Circuit Breakers GV2L

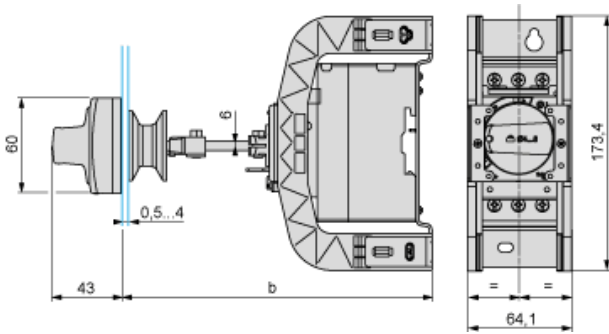

	b	
	Minimum	Maximum
GV2 APN.. + GV APH02	151	250
GV2 APN.. + GV APH02 + GV APK11	250	445

#### Door cut-out

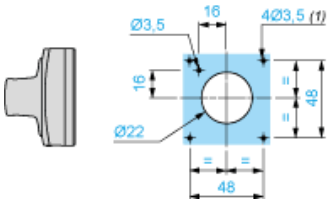

(1) For IP65 only.

## GV2L and GV2LE

Sets of busbars GV2G445, GV2G454, GV2G472, with terminal block GV2G05

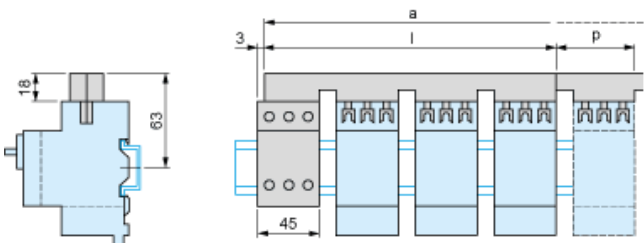

	l	p		
GV2G445 (4 x 45 mm)	179	45		
GV2G454 (4 x 54 mm)	206	54		
GV2G472 (4 x 72 mm)	260	72		
Number of tap-offs	a			
	5	6	7	8
GV2G445	224	269	314	359
GV2G454	260	314	368	422
GV2G472	332	404	476	548

### Sets of Busbars for GV2L and GV2LE

Sets of busbars GV2G... with terminal block GV1G09

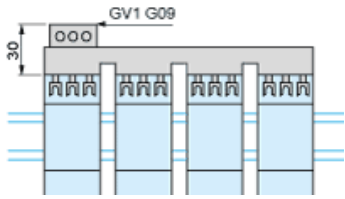

Sets of busbars GV2G245, GV2G254, GV2GR272

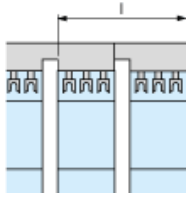

	l
GV2G245 (2 x 45 mm)	89
GV2G254 (2 x 54 mm)	98
GV2G272 (2 x 72 mm)	116

Set of busbars GV2G554

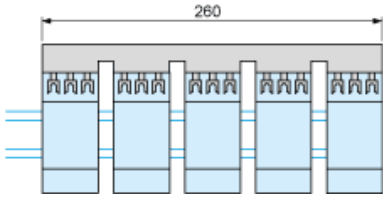

Sets of busbars GV2G345 and GV2G354

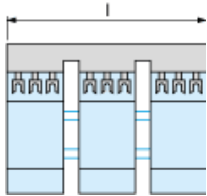

	l
GV2G345 (3 x 45 mm)	134
GV2G354 (3 x 54 mm)	152

GV2L••

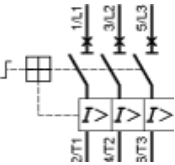

**Recommended replacement(s)**