

Product data sheet

Specifications



variable speed drive, Altivar Process
ATV600, ATV630, 220kW, 350hp,
380 to 480V, IP00

ATV630C22N4

Product availability : Stock - Normally stocked in distribution facility

Price* : 23,100.00 USD

Main

Range of Product	Altivar Process ATV600
Product or Component Type	Variable speed drive
Product Specific Application	Process and utilities
Device short name	ATV630
Variant	Standard version
Product destination	Asynchronous motors Synchronous motors
EMC filter	Integrated 164.04 ft (50 m) EN/IEC 61800-3 category C3
IP degree of protection	IP00IEC 61800-5-1 IP00IEC 60529 IP21 with kit VW3A9112)IEC 61800-5-1 IP21 with kit VW3A9112)IEC 60529
[Us] rated supply voltage	380...480 V
Type of cooling	Forced convection
Supply frequency	50...60 Hz - 5...5 % 380...480 V - 15...10 %
Motor power kW	160 kW heavy duty) 220 kW normal duty)
Maximum Horse Power Rating	350 hp normal duty 250 hp heavy duty
Line current	397 A 380 V normal duty) 324 A 480 V normal duty) 296 A 380 V heavy duty) 246 A 480 V heavy duty)
Prospective line Isc	50 kA
Apparent power	247 kVA 480 V normal duty) 187 kVA 480 V heavy duty)
Continuous output current	302 A 2.5 kHz heavy duty 427 A 2.5 kHz normal duty
Asynchronous motor control profile	Constant torque standard Variable torque standard Optimized torque mode
Synchronous motor control profile	Permanent magnet motor Synchronous reluctance motor
Speed drive output frequency	0.1...500 Hz
Nominal switching frequency	2.5 kHz

* Price is "List Price" and may be subject to a trade discount – check with your local distributor or retailer for actual price.

Switching frequency	2.5...8 kHz with derating factor 2...8 kHz adjustable
Safety function	STO (safe torque off) SIL 3
Discrete input logic	16 preset speeds
Communication Port Protocol	Modbus TCP Ethernet Modbus serial
Option card	Slot A communication module, Profibus DP V1 Slot A communication module, PROFINET Slot A communication module, DeviceNet Slot A communication module, Modbus TCP/EtherNet/IP Slot A communication module, CANopen daisy chain RJ45 Slot A communication module, CANopen SUB-D 9 Slot A communication module, CANopen screw terminals Slot A/slot B digital and analog I/O extension module Slot A/slot B output relay extension module Slot A communication module, Ethernet IP/Modbus TCP/MD-Link communication module, BACnet MS/TP communication module, Ethernet Powerlink

Complementary

Mounting Mode	Wall mount
Maximum transient current	453 A 60 s heavy duty) 470 A 60 s normal duty)
Phase	3 phase
Discrete output number	0
Discrete output type	Relay outputs R1A, R1B, R1C 250 V AC 3000 mA Relay outputs R1A, R1B, R1C 30 V DC 3000 mA Relay outputs R2A, R2C 250 V AC 5000 mA Relay outputs R2A, R2C 30 V DC 5000 mA Relay outputs R3A, R3C 250 V AC 5000 mA Relay outputs R3A, R3C 30 V DC 5000 mA
Output voltage	<= power supply voltage
Permissible temporary current boost	1.1 x In 60 s normal duty) 1.5 x In 60 s heavy duty)
Motor slip compensation	Adjustable Automatic whatever the load Not available in permanent magnet motor law Can be suppressed
Acceleration and deceleration ramps	Linear adjustable separately from 0.01...9999 s
Physical interface	Ethernet 2-wire RS 485
Braking to standstill	By DC injection
Protection type	Thermal protection motor Safe torque off motor Motor phase break motor Thermal protection drive Safe torque off drive Overheating drive Overcurrent between output phases and earth drive Overload of output voltage drive Short-circuit protection drive Motor phase break drive Overvoltages on the DC bus drive Line supply overvoltage drive Line supply undervoltage drive Line supply phase loss drive Overspeed drive Break on the control circuit drive
Transmission Rate	10, 100 Mbits 4800 bps, 9600 bps, 19200 bps, 38.4 Kbps
Frequency resolution	Display unit 0.1 Hz Analog input 0.012/50 Hz
Transmission frame	RTU
Electrical connection	Control removable screw terminals 0.5...1.5 mm ² AWG 20...AWG 16 Line side screw terminal 2 x 150 mm ² 2 x 350 kcmil Motor screw terminal 2 x 150 mm ² 2 x 350 kcmil

Connector type	RJ45 on the remote graphic terminal)Ethernet/Modbus TCP RJ45 on the remote graphic terminal)Modbus serial
Data format	8 bits, configurable odd, even or no parity
Type of polarization	No impedance
Exchange mode	Half duplex, full duplex, autonegotiation Ethernet/Modbus TCP
Number of addresses	1...247 Modbus serial
Method of access	Slave Modbus TCP
Supply	External supply for digital inputs 24 V DC 19...30 V), <1.25 mA overload and short-circuit protection Internal supply for reference potentiometer (1 to 10 kOhm) 10.5 V DC +/- 5 %, <10 mA overload and short-circuit protection Internal supply for digital inputs and STO 24 V DC 21...27 V), <200 mA overload and short-circuit protection
Local signalling	for local diagnostic 3 LEDs for embedded communication status 3 LEDs (dual colour) for communication module status 4 LEDs (dual colour) for presence of voltage 1 LED (red)
Width	17.32 in (440 mm)
Height	47.05 in (1195 mm)
Depth	14.96 in (380 mm)
Net Weight	379.20 lb(US) (172 kg)
Analogue input number	3
Analogue input type	AI1, AI2, AI3 software-configurable voltage 0...10 V DC 31.5 kOhm 12 bits AI1, AI2, AI3 software-configurable current 0...20 mA 250 Ohm 12 bits AI2 voltage analog input - 10...10 V DC 31.5 kOhm 12 bits
Discrete input number	8
Discrete input type	DI7, DI8 programmable as pulse input 0...30 kHz, 24 V DC <= 30 V)
Input compatibility	DI1...DI6 discrete input level 1 PLC EN/IEC 61131-2 DI5, DI6 discrete input level 1 PLC IEC 65A-68 STOA, STOB discrete input level 1 PLC EN/IEC 61131-2
Discrete input logic	Positive logic (source) DI1...DI8), < 5 V, > 11 V Negative logic (sink) DI1...DI8), > 16 V, < 10 V
Analogue output number	2
Analogue output type	Software-configurable voltage AQ1, AQ2 0...10 V DC 470 Ohm 10 bits Software-configurable current AQ1, AQ2 0...20 mA 10 bits Software-configurable current DQ-, DQ+ 30 V DC Software-configurable current DQ-, DQ+ 100 mA
Sampling duration	2 ms +/- 0.5 ms DI1...DI4) - discrete input 5 ms +/- 1 ms DI5, DI6) - discrete input 5 ms +/- 0.1 ms AI1, AI2, AI3) - analog input 10 ms +/- 1 ms AO1) - analog output
Accuracy	+/- 0.6 % AI1, AI2, AI3 for a temperature variation 60 °C analog input +/- 1 % AO1, AO2 for a temperature variation 60 °C analog output
Linearity error	AI1, AI2, AI3 +/- 0.15 % of maximum value analog input AO1, AO2 +/- 0.2 % analog output
Relay output number	3
Relay output type	Configurable relay logic R1 fault relay NO/NC 100000 cycles Configurable relay logic R2 sequence relay NO 100000 cycles Configurable relay logic R3 sequence relay NO 100000 cycles
Refresh time	Relay output R1, R2, R3)5 ms +/- 0.5 ms)
Minimum switching current	Relay output R1, R2, R3 5 mA 24 V DC
Maximum switching current	Relay output R1, R2, R3 resistive, cos phi = 1 3 A 250 V AC Relay output R1, R2, R3 resistive, cos phi = 1 3 A 30 V DC Relay output R1, R2, R3 inductive, cos phi = 0.4 7 ms 2 A 250 V AC Relay output R1, R2, R3 inductive, cos phi = 0.4 7 ms 2 A 30 V DC
Isolation	Between power and control terminals
Maximum output frequency	500 kHz
Maximum Input Current per Phase	397.0 A

Variable speed drive application selection	Building - HVAC compressor centrifugal Food and beverage processing other application Mining mineral and metal fan Mining mineral and metal pump Oil and gas fan Water and waste water other application Building - HVAC screw compressor Food and beverage processing pump Food and beverage processing fan Food and beverage processing atomization Oil and gas electro submersible pump (ESP) Oil and gas water injection pump Oil and gas jet fuel pump Oil and gas compressor for refinery Water and waste water centrifuge pump Water and waste water positive displacement pump Water and waste water electro submersible pump (ESP) Water and waste water screw pump Water and waste water lobe compressor Water and waste water screw compressor Water and waste water compressor centrifugal Water and waste water fan Water and waste water conveyor Water and waste water mixer
---	--

Motor power range AC-3	110...220 kW 380...440 V 3 phase 110...220 kW 480...500 V 3 phase
-------------------------------	--

Quantity per Set	1
-------------------------	---

Enclosure mounting	Wall mounted
---------------------------	--------------

Environment

Insulation resistance	> 1 MOhm 500 V DC for 1 minute to earth
------------------------------	---

Noise level	66 dB 86/188/EEC
--------------------	------------------

Power dissipation in W	Forced convection 5030 W Natural convection 451 W 380 V 2.5 kHz
-------------------------------	--

Volume of cooling air	227192.03 Gal/hr(US) (860 m3/h)
------------------------------	---------------------------------

Operating position	Vertical +/- 10 degree
---------------------------	------------------------

Maximum THDI	<48 % full load IEC 61000-3-12
---------------------	--------------------------------

Electromagnetic compatibility	Electrostatic discharge immunity test level 3 IEC 61000-4-2 Radiated radio-frequency electromagnetic field immunity test level 3 IEC 61000-4-3 Electrical fast transient/burst immunity test level 4 IEC 61000-4-4 1.2/50 µs - 8/20 µs surge immunity test level 3 IEC 61000-4-5 Conducted radio-frequency immunity test level 3 IEC 61000-4-6
--------------------------------------	--

Pollution degree	2 EN/IEC 61800-5-1
-------------------------	--------------------

Vibration resistance	1.5 mm peak to peak 2...13 Hz)IEC 60068-2-6 1 gn 13...200 Hz)IEC 60068-2-6
-----------------------------	---

Shock resistance	15 gn 11 ms IEC 60068-2-27
-------------------------	----------------------------

Relative humidity	5...95 % without condensation IEC 60068-2-3
--------------------------	---

Ambient air temperature for operation	14...104 °F (-10...40 °C) without derating) 104...140 °F (40...60 °C) with derating factor)
--	--

Ambient Air Temperature for Storage	-13...158 °F (-25...70 °C)
--	----------------------------

Operating altitude	<= 3280.84 ft (1000 m) without derating 3280.84...9842.52 ft (1000...3000 m) with current derating 1 % per 100 m
---------------------------	---

Product Certifications	TÜV CSA UL
-------------------------------	------------------

Marking	CE
----------------	----

Standards	UL 508C EN/IEC 61800-3 EN/IEC 61800-3 environment 1 category C2 EN/IEC 61800-3 environment 2 category C3 EN/IEC 61800-5-1 IEC 61000-3-12 IEC 60721-3 IEC 61508 IEC 13849-1
------------------	--

Overvoltage category	III
Regulation loop	Adjustable PID regulator
	73 dB
	2

Ordering and shipping details

Category	22207-ATV630 FRAMES 5 & 6
Discount Schedule	CP4E
GTIN	3606481154712
Returnability	Yes
Country of origin	CN

Packing Units

Unit Type of Package 1	PCE
Number of Units in Package 1	1
Package 1 Height	26.77 in (68.0 cm)
Package 1 Width	23.62 in (60.0 cm)
Package 1 Length	55.12 in (140.0 cm)
Package 1 Weight	396.83 lb(US) (180.0 kg)

Offer Sustainability

California proposition 65	WARNING: This product can expose you to chemicals including: Lead and lead compounds, which is known to the State of California to cause cancer and birth defects or other reproductive harm. For more information go to www.P65Warnings.ca.gov
REACH Regulation	REACH Declaration
EU RoHS Directive	Pro-active compliance (Product out of EU RoHS legal scope) EU RoHS Declaration
Mercury free	Yes
China RoHS Regulation	China RoHS declaration
RoHS exemption information	Yes
WEEE	The product must be disposed on European Union markets following specific waste collection and never end up in rubbish bins.
Upgradeability	Upgraded components available

Dimensions

Rear, Right and Front Views

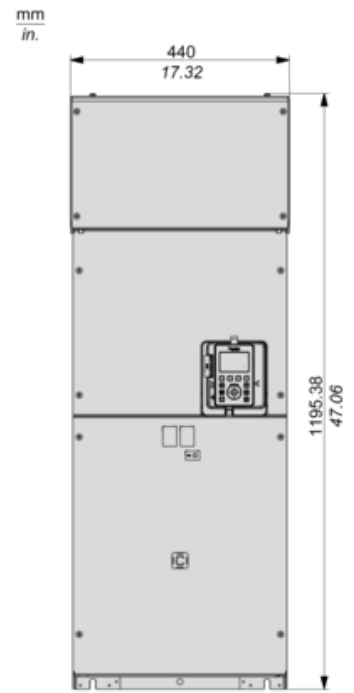
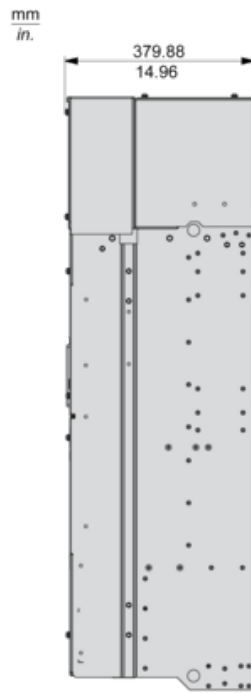
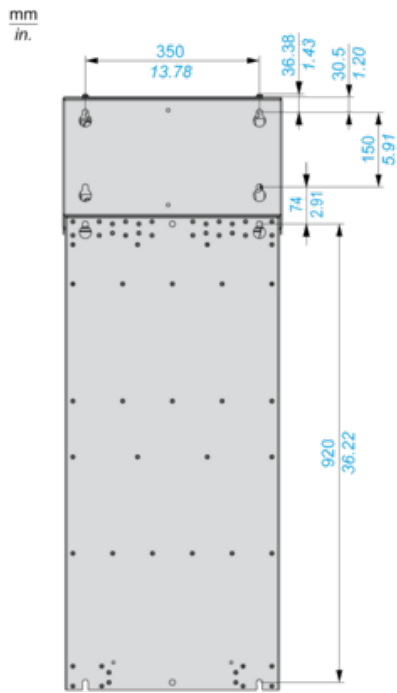

Clearances



X1	X2	X3
≥ 200 mm (7.87 in.)	≥ 150 mm (5.91 in.)	≥ 10 mm (0.39 in.)

Mounting Types

Mounting Type A: Individual IP21



$a \geq 0$

Mounting Type B: Side by Side IP20

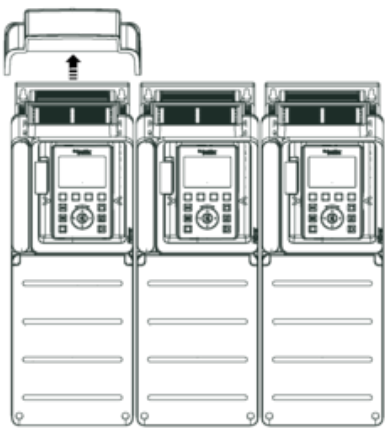

Mounting Type C: Individual IP20



$a \geq 0$

Three-Phase Power Supply with Upstream Breaking via Line Contactor

Connection diagrams conforming to standards EN 954-1 category 1 and IEC/EN 61508 capacity SIL1, stopping category 0 in accordance with standard IEC/EN 60204-1



(1) Line choke if used

(2) Use relay R1 set to operating state Fault to switch Off the product once an error is detected.

A1 : Drive

KM1 : Line Contactor

Q2, Q3 : Circuit breakers

S1, S2 : Pushbuttons

T1 : Transformer for control part

Three-Phase Power Supply with Downstream Breaking via Contactor

Connection diagrams conforming to standards EN 954-1 category 1 and IEC/EN 61508 capacity SIL1, stopping category 0 in accordance with standard IEC/EN 60204-1



(1) Line choke if used

(2) Use relay R1 set to operating state Fault to switch Off the product once an error is detected.

A1 : Drive

KM1 : Contactor

Control Block Wiring Diagram



- (1) Safe Torque Off
- (2) Analog Output
- (3) Digital Input
- (4) Reference potentiometer
- (5) Analog Input
- R1A, R1B, R1C** : Fault relay
- R2A, R2C** : Sequence relay
- R3A, R3C** : Sequence relay

Sensor Connection

It is possible to connect either 1 or 3 sensors on terminals AI2 or AI3.

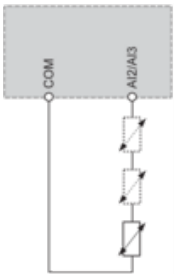

Sink / Source Switch Configuration

The switch is used to adapt the operation of the logic inputs to the technology of the programmable controller outputs.

- Set the switch to Source (factory setting) if using PLC outputs with PNP transistors.
- Set the switch to Ext if using PLC outputs with NPN transistors.

Switch Set to SRC (Source) Position Using the Output Power Supply for the Digital Inputs



Switch Set to SRC (Source) Position and Use of an External Power Supply for the DIs

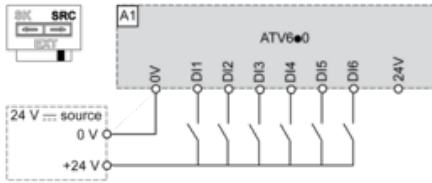

Switch Set to SK (Sink) Position Using the Output Power Supply for the Digital Inputs



Switch Set to EXT Position Using an External Power Supply for the DIs

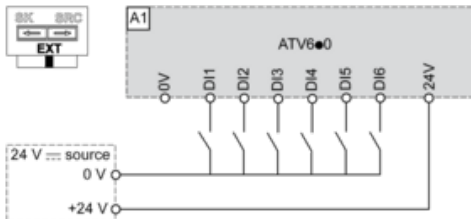

Derating Curves

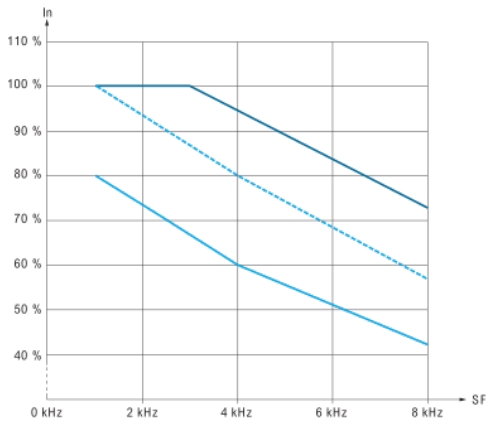

- 40 °C (104 °F)
- ⋯ 50 °C (113 °F)
- 60 °C (140 °F)

In : Nominal Drive Current

SF : Switching Frequency

Recommended replacement(s)