

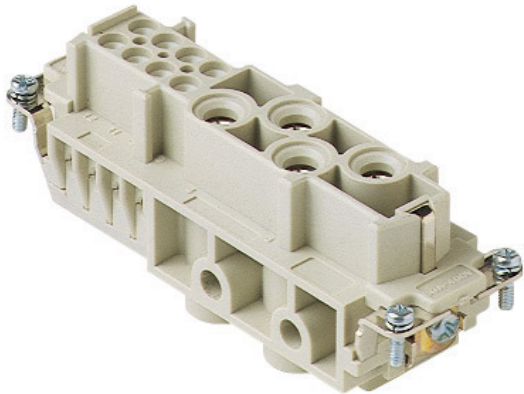

Part number

**CXF 4/8**



Female insert, CX series, screw terminal connection, 4 + 8 poles + PE, 80 A 400 V 6 kV 3 / 16 A 230/400 V 4 kV 3, size "104.27"

**Product description**

<b>Product type</b>	Insert
<b>Series</b>	CX
<b>Connection type</b>	Screw terminal connection
<b>Gender</b>	Female
<b>N. of poles</b>	4 poles + 
<b>Auxiliary poles</b>	8 poles
<b>Size</b>	Size "104.27"

**Technical data**

<b>Current</b>	80 A
<b>Voltage</b>	400 V
<b>Rated impulse withstand voltage</b>	6 kV
<b>Pollution degree</b>	3
<b>Rated voltage according to UL/CSA</b>	600 V
<b>Wire cross-section</b>	4,00 mm <sup>2</sup> - 16,00 mm <sup>2</sup>
<b>AWG size</b>	12 - 6
<b>Contact type</b>	Turned silver plated
<b>IP degree of protection</b>	IP20 without enclosure, IP65/IP66/IP68/IP69 with enclosure

**Further technical details**

<b>Characteristics according to EN 61984</b>	80A 400V 6kV 3 (aux:16A 230/400V 4kV 3); 80A 400/690V 6kV 2 (aux:16A 400V 4kV 2)
<b>Mating cycles</b>	≥ 500
<b>Insulation resistance</b>	≥ 10 GΩ
<b>Weight</b>	150,00 g
<b>Operating temperature range (min, max)</b>	-40 °C ... +125 °C
<b>UL 94 flammability rating</b>	V-0

**Material properties**

<b>Main material</b>	Polycarbonate (PC)
<b>Other materials</b>	Contacts: copper alloy
<b>Colour</b>	RAL 7032 grey
<b>RoHs conformity</b>	Compliant with exemption 6(c): copper alloy containing up to 4% lead by weight
<b>China RoHs - EFUP</b>	50
<b>REACH SVHC substances</b>	Yes Lead

**Approvals / Standards**

<b>Reference standard</b>	EN 61984:2009-06
<b>Certifications</b>	CSA, CQC, DNV-GL, BV, EAC
<b>UL</b>	ECBT2
<b>cUL</b>	ECBT8

**General ordering information**

<b>EAN13 code</b>	8015747042352
<b>eCl@ss 8.1</b>	27440205
<b>ETIM 7.0</b>	EC000438

**Packaging Information**

<b>Packaging length</b>	245,00 mm
<b>Packaging height</b>	165,00 mm
<b>Packaging width</b>	215,00 mm
<b>Packaging weight</b>	4,89 kg
<b>Packaging volume</b>	8,69 dm <sup>3</sup>
<b>Packaging description</b>	Carton box
<b>Packaging quantity</b>	30 Pcs
<b>Packaging EAN code</b>	8015747191852
<b>Sub-packaging length</b>	113,00 mm
<b>Sub-packaging height</b>	36,00 mm
<b>Sub-packaging width</b>	180,00 mm
<b>Sub-packaging weight</b>	0,82 kg
<b>Sub-packaging volume</b>	0,73 dm <sup>3</sup>
<b>Sub-packaging description</b>	Carton tray
<b>Sub-packaging quantity</b>	5 Pcs
<b>Sub-packaging EAN barcode</b>	8015747042369

Part number

# CXF 4/8



Catalogue drawings

Catalogue drawings

## CXM 4/8

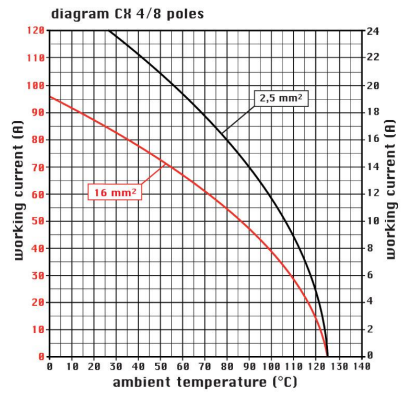
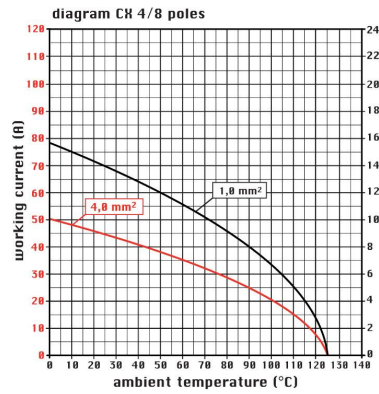
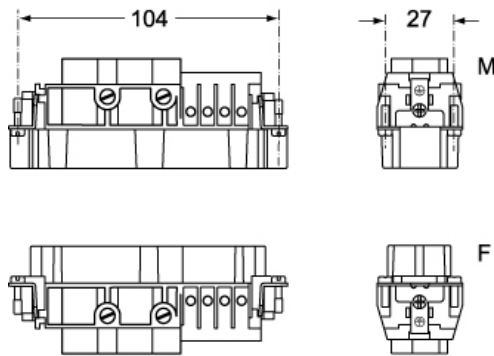

## CXF 4/8

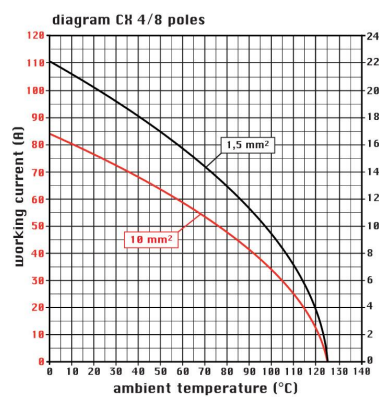
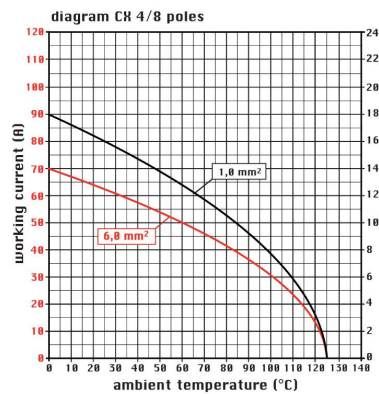
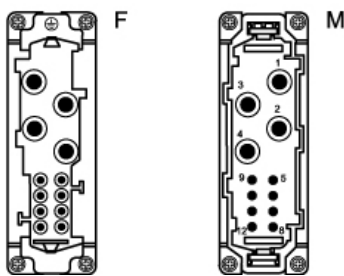

## Notes

Dimensions shown in mm are not binding and may be changed without notice.