

Part number

CHI 16 CP



Bulkhead mounting housing, C-TYPE series, with 4 pegs, size "77.27", with plastic cover

Product description

Product type	Bulkhead mounting housing
Series	C-TYPE
Closing type	With 4 pegs
Size	Size "77.27"
Specification	With plastic cover

Technical data

IP degree of protection	IP65
--------------------------------	------

Further technical details

Weight	130,00 g
Operating temperature range (min, max)	-40°C...+125°C

Material properties

Colour	RAL 7040 grey
RoHs conformity	Compliant
China RoHs - EFUP	E
REACH SVHC substances	No

Approvals / Standards

Certifications	DNV-GL, BV
UL	ECBT2
cUL	ECBT8

General ordering information

EAN13 code	8015747017770
eCl@ss 8.1	27440202
ETIM 7.0	EC000437

Packaging Information

Packaging length	330,00 mm
Packaging height	170,00 mm
Packaging width	230,00 mm
Packaging weight	2,71 kg
Packaging volume	12,90 dm ³
Packaging description	Carton box
Packaging quantity	20 Pcs
Packaging EAN code	8015747017787
Sub-packaging weight	0,68 kg
Sub-packaging description	Plastic packaging
Sub-packaging quantity	5 Pcs
Sub-packaging EAN barcode	8015747017794

Part number

CHI 16 CP



Catalogue drawings

Catalogue drawings

CHI

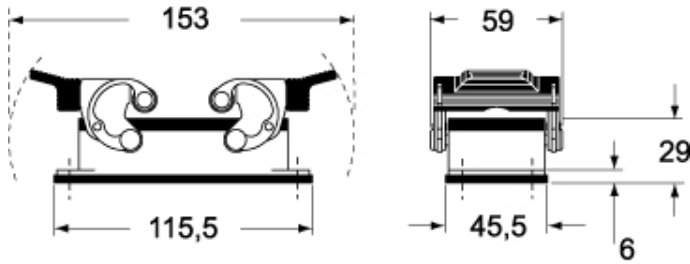

CHI C

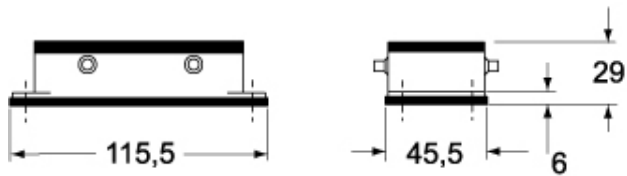

CHI CS/CP

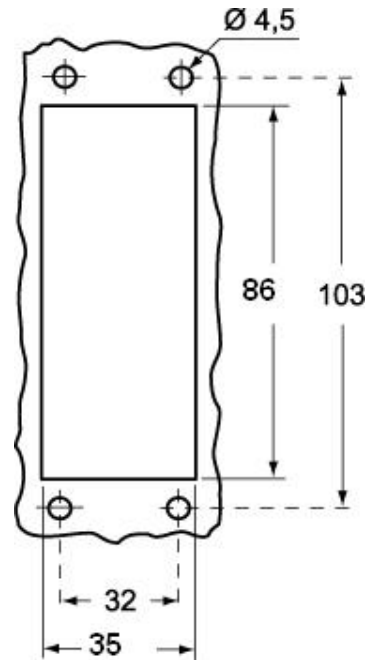
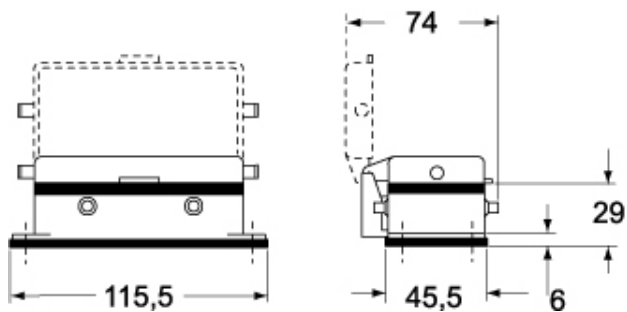

Notes

Dimensions shown in mm are not binding and may be changed without notice.