

Z170REG-1

**Universal converter module
with galvanic insulation
between 2 analog outputs**

Chapter index	Page
1. Identification data	1
2. Preliminary warnings	2
3. Description and characteristics	2
3.1 Module description	
3.2 General characteristics and features	
4. Technical specifications	2
4.1 Inputs	
4.2 Outputs	
4.3 Connections	
4.4 1500 V~ insulations	
4.5 Power supply	
4.6 Module case	
4.7 Environmental conditions	
4.8 Standards	
5. Preliminary instructions for use	5
6. Electrical connections	5
6.1 Safety measures before use	
6.2 USB interface	
6.3 Connections	
7. Parameters for use	6
7.1 Setting parameters	
7.2 Dip - Switch tables	
7.3 Default configuration	
8. Decommissioning and disposal	10
9. Purchase order code	10
10. Module layout	10
10.1 Module layout and signalling LEDs	
10.2 Block diagram	



➔ **IN, OUT1, OUT2, power supply are isolated (1500V~)**

➔ **IN, OUT1, OUT2 are:**

- **Analog and universal**
- **Setting by Dip-Switches**



SENECA s.r.l.

Via Austria, 26 – 35127 – PADOVA – ITALY

Tel. +39.049.8705355 – 8705359 Fax. +39.049.8706287

Internet site: www.seneca.it Technical assistance: support@seneca.it

Commercial reference: sales@seneca.it

This document is property of SENECA srl. Duplication and reproduction of its are forbidden (though partial), if not authorized. Contents of present documentation refers to products and technologies described in it. Though we strive for reach perfection continually, all technical data contained in this document may be modified or added due to technical and commercial needs; it's impossible eliminate mismatches and discordances completely. Contents of present documentation is anyhow subjected to periodical revision. If you have any questions don't hesitate to contact our structure or to write us to e-mail addresses as above mentioned.

2. PRELIMINARY WARNINGS

 Before carrying out any operation it's mandatory to read all the content of this user Manual. Only electrical-skilled technicians can use the module described in this user Manual.

 Only the Manufacturer is authorized to repair the module or to replace damaged components.

 No warranty is guaranteed in connection with faults resulting from improper use, from modifications or repairs carried out by Manufacturer-unauthorised personnel on the module, or if the content of this user Manual is not followed.

3. DESCRIPTION AND CHARACTERISTICS

3.1 MODULE DESCRIPTION

The Z170REG module acquires 1 universal input signal and converts it to an analog format, sent through 2 universal output signals (regardless and isolated with each other).

3.2 GENERAL CHARACTERISTICS AND FEATURES

- It's possible to choose if the input is: voltage type, current type, potentiometer type, thermocouple (TC) type, RTD (Resistance Temperature Detector) type.
- It's possible to choose if each output is: voltage type, active/passive current type.
- 1500 V ~ insulation between: input, power supply, output 1 and output 2 (figure 1).
- It's possible to power the sensor if input is in current type modality (max 17V).
- It's possible to configure by Dip-Switch or by software (available at www.seneca.it) modality: input-type, outputs-type, start / end scale of each selected input and outputs-type
- It's possible to configure by software: input filter, rejection, burn-out, etc..

4. TECHNICAL SPECIFICATIONS

4.1 INPUTS

Number	1
Resolution	14 bits
Sampling time	Configurable between: 16.66 ms (rejection to 60 Hz), 20 ms (rejection to 50 Hz) or 5ms (keine rejection).
Filter	Level configurable between: 0(no filter is applied) – 19
Response time	Sampling time +6 ms
Voltage-type Input (1)	Scale span configurable: from 0 to 10V \approx . Input impedance: 120 k Ω . Input automatic out of range detection.
Current-type Input (passive module / active module) (1)	Scale span configurable: from 0 mA to 20 mA. Internal shunt: 50 Ω . It's possible to power the sensor by: itself (passive module) or by module (active module using #7 screw terminal, max 25 mA to max 17 V, short-circuit protected). Input automatic out of range detection.
Potentiometer type Input (1)	Scale span configurable: from 1 % to 100 %. Potentiometer input value from 1 k Ω to 100 k Ω (a R= 330 Ω parallel circuit must be added). Energising current: 1 mA. Input impedance: > 5 M Ω . Input automatic out of range detection.
Thermocouple type Input (1)	For TC type: J, K, R, S, T, B, E, N. Input impedance: > 5 M Ω . Input automatic burn-out detection. Range from -10 mV to +70 mV. Input impedance: > 5 M Ω .
RTD-type Input (1)	For RTD type: PT100, PT500, PT1000, NI100. Resistance measure (for 2,3,4-wires connection) and wire-resistance measure. Excitation current: 1.1 mA (PT100) and 0.11 mA (PT1000, PT500). Input automatic burn-out detection.

Errors related to max measuring range	Accuracy	Thermal stability	Linearity error	EMI
Voltage or current-input type	0.1%	0.01%/°K	0.05%	<1% (2)
TC-input type: J, K, E, T, N	0.1%	0.01%/°K	0.2°C	<1% (2)
TC-input type: R, S	0.1%	0.01%/°K	0.5°C	<1% (2)
TC-input type: B (3)	0.1%	0.01%/°K	1.5°C	<1% (2)
Cold junction compensation (for TC-input type)	2°C between 0-50°C	/	/	/
POT-input type	0.1%	0.01%/°K	0.1%	<1%
RTD-input type (4)	0.1%	0.01%/°K	0.02%(if t>0°C)	<1% (5)

(1)For the input scale ranges, see tables 3 – 4 (description of all start/end-scale settings by Dip-Switches modality for each selected input type)

(2)Influence of wire resistance: 0.1 uV/Ω

(3)Output zero if t < 250°C

(4)For RTD type: PT100, PT500, PT1000, NI100. All the errors have to be calculated with reference to resistive value

(5)Influence of wire resistance: 0.005 %/Ω, max 20 Ω

4.2 OUTPUTS

Number	2			
Resolution	14 bits			
Signal-amplitude limiting	The output signal can be amplitude-limited by a «limiter» (for each output)			
Voltage-type OUT	Configurable between: 0 – 10 V (Maximum connectable output load: 2 kΩ)			
Current-type OUT (active or passive)	Configurable between: 0 – 20 mA (maximum resistance that can be connected: 600 Ω, max 13 V $\overline{=}$). «Active current»=the output: already powered on, needs to be connected to the passive module (es. multimeter); «passive current»=the output: powered off, needs to be connected to the active module (es. active input of a PLC)			
Errors related to max measuring range	Accuracy	Thermal stability	Linearity error	EMI
Voltage-type OUT(6)	0.1%	0.01%/°K	0.01%	< 1%
Current-type OUT (active or passive) (6)	0.1%	0.01%/°K	0.01%	< 1%

(6)These values have to be added to the errors of the selected input.

4.3 CONNECTIONS

USB interface	Micro USB connector (front-side panel)
---------------	--

4.4 1500 V ~ INSULATIONS

The isolation voltage between:

- power supply
 - analog input
 - analog output 1
 - analog output 2
- is **1500 V ~** (figure 1).

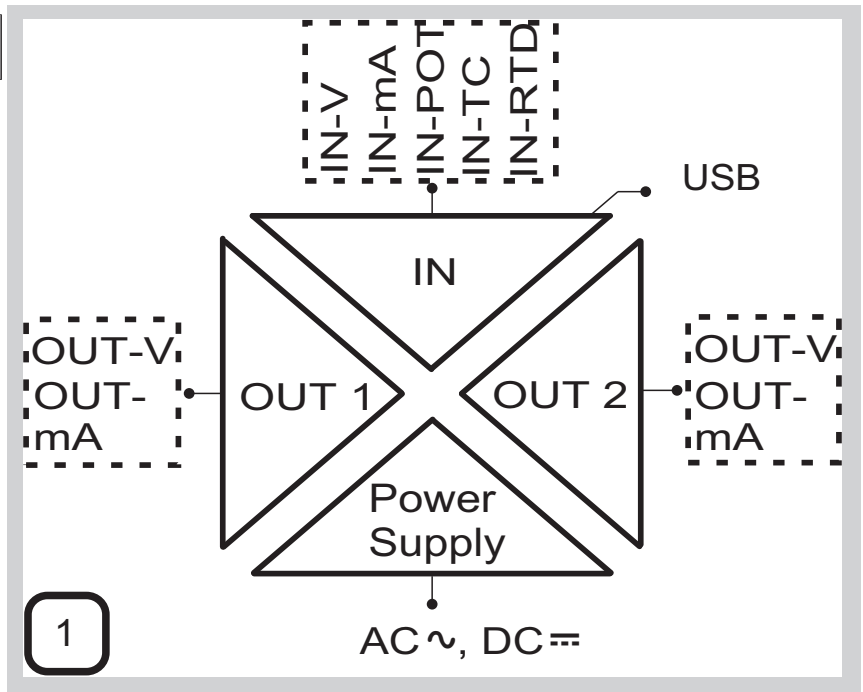

4.5 POWER SUPPLY

Supply voltage	10 – 40 V $\overline{=}$ or 19 – 28 V \sim (50Hz-60Hz), between 2 –3 screw terminals
Power-supply unit	Class 2
Power consumption	Min: 0.5 W; Max: 2 W

Install a 2.5 A-Max rated fuse near the module.

4.6 MODULE CASE

Box	PA6, black
Dimensions	Width W = 100 mm, Height H = 112 mm, Depth D = 17.5 mm
Terminal board	Removable 3-way screw terminals: pitch 5.08 mm, section 2.5 mm ²
Protection class	IP20 (International Protection)

4.6 ENVIRONMENTAL CONDITIONS

Operating temperature	-10°C – +60°C (UL: -10°C – +60°C)
Humidity	30 – 90% to 40°C not condensing (during operation)
Max environment pollution degree	2 (during operation)
Storage temperature	-20°C – +85°C

4.7 STANDARDS

The module complies with the following standards:

- EN 61000-6-4 (electromagnetic emission, in industrial environment)
- EN 61000-6-2 (electromagnetic immunity, in industrial environment)
- EN 61010-1(safety).

One Max 2.5 A fuse must be installed near the module.

5. PRELIMINARY INSTRUCTIONS FOR USE

The module is designed to be installed on DIN rail IEC EN 60715 in vertical position.



It is forbidden to place anything that could obstructs the ventilation slits.
It is forbidden to install the module near heat sources.



Severe operating condions are as follow:

- high power supply voltage: $>30\text{ V}\overline{=}$ or $> 26\text{ V}\sim$.
- Module power supply the sensor at input;
- Output used as current generator (connected to a passive module)



If the modules are installed side by side, **separate them by at least 5 mm** in the following cases:

- the operating temperature exceeds 45°C and at least one of the severe operating conditions exists; or
- the operating temperature exceeds 35°C and at least two of the severe operating conditions exist.

6. ELECTRICAL CONNECTIONS

6.1 SAFETY MEASURES BEFORE USE



To satisfy the electromagnetic compliance requirements:

- use shielded cables for signal transmission;
- connect the shield to a earth wire used specifically for instrumentation;
- insert space between these shielded cables and other cables used for power appliances (inverters, motors, induction ovens, etc...).

6.2 USB INTERFACE

The module has a microUSB connector, you can configure it through APP and/or software. Programming tools, manuals, templates, examples, etc. for the product can be downloaded free of charged at www.seneca.it in the Z170REG section.

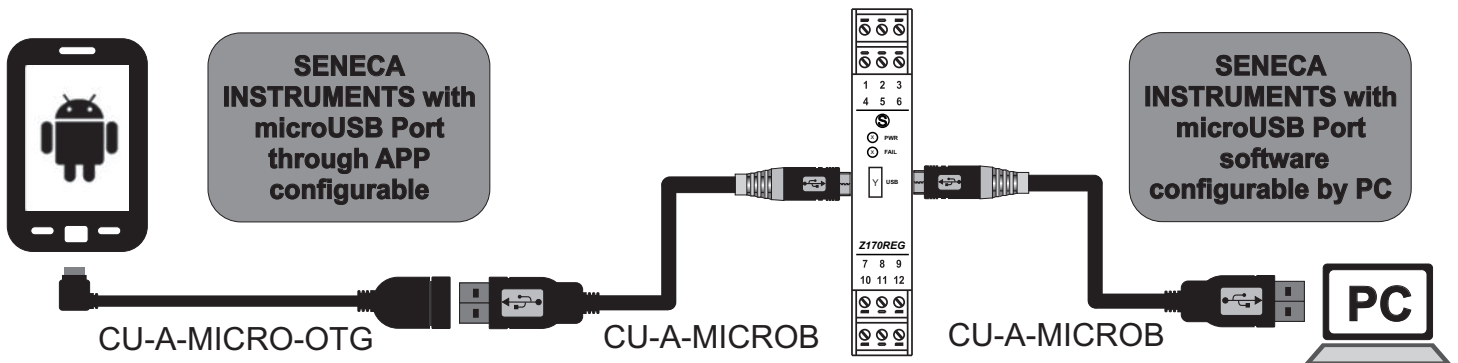

6.3 CONNECTIONS



Power on the module with $< 40\text{ V}\overline{=}$ or $< 28\text{ V}\sim$ voltage supply. These upper limits must not be exceeded to avoid serious damage to the module.

POWER SUPPLY

2		19 – 28 V \sim
3		10 – 40 V $\overline{=}$
		2 W Max

INPUTS (SENSORS «S» CONNECTION)

Passive module

The sensor power the loop (in mA)

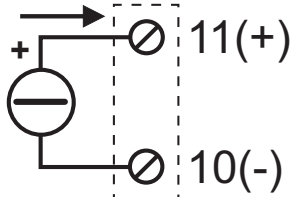

Voltage

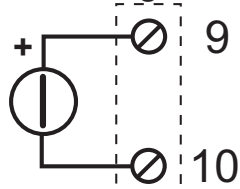

With $R = 330 \Omega$ (it needs to be added externally), $P = 1 \text{ k}\Omega - 100 \text{ k}\Omega$

3

Active module

The module power the loop (in mA)

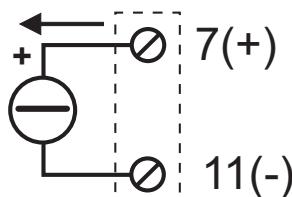

mV/TC

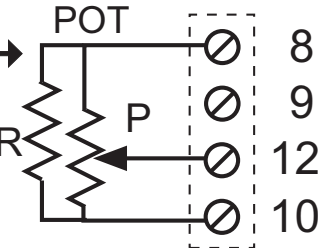
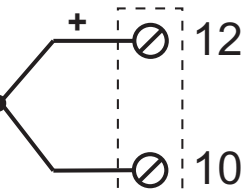

2-wire RTD

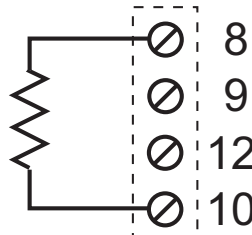

3-wire RTD

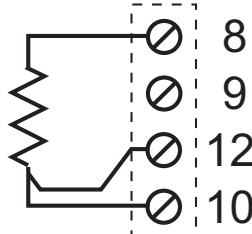

4-wire RTD

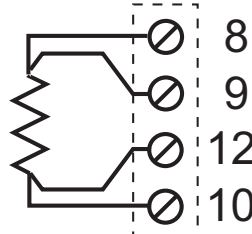

OUTPUT 1

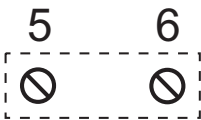

Voltage

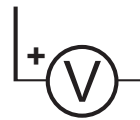

Current (Z170REG active)

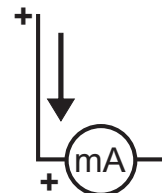

Current (Z170REG passive)

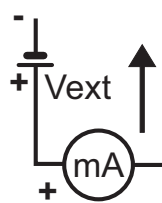

OUTPUT 2

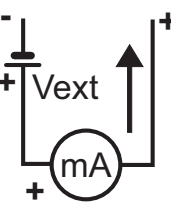
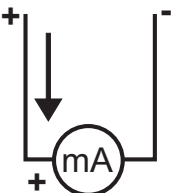
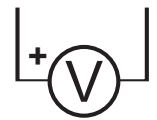

7. PARAMETERS FOR USE

7.1 SETTING PARAMETERS

Parameters	Modality	Options
Input type	Software/ DipSwitch	Voltage, Current, Potentiometer, TC, RTD; if Dip-Switch modality then see table 1
mV Input type	Software	mV Voltage configurable only by software
Input filter	Software	Activated/Disactivated; if activated: from 0 to 19
Input start/end scale	Software/ DipSwitch	If Dip-Switch modality, see tables 3 – 4
Output 1, 2 type	Software/ DipSwitch	Voltage, Current (active, passive); if Dip-Switch modality then see table 2
Output 1,2 start/end scale	Software/ DipSwitch	If Dip-Switch modality, see table 2
Output 1,2 limiters	Software	Activated/Disactivated; if deactivated, output limits are: if OUT=voltage, [0 V; 10.5 V]; if OUT=current, [0 mA; 21 mA]
Network frequency rejection/sampling time	Software	No rejection: 5 ms («Fast»); 50 Hz-rejection: 20 ms; 60 Hz-rejection: 16.66 ms
(for TC-type input) Cold junction compensation	Software	Activated/Disactivated
Detection of input fail: over-scala input error or burn-out error	Software	Activated/Disactivated (for OUT1 and OUT2); if activated: the two «Fault values» (for each output) have to be configured

7.2 DIP-SWITCH TABLES



The module acquires the parameters through Dip-Switches, if the module Dip-Switches are configured as shown in the following tables 1, 2, 3, 4. For whatever other Dip-Switches configuration, ALL parameters are acquired from memory, regardless of the Dip-Switches configuration.



In the following tables: box without circle means Dip-Switch=0 (OFF state); box with circle means Dip-Switch=1 (ON state); box with X means indifferent (ON state or OFF state are both usable)

Table 1 - INPUT TYPE (Dip-Switches SW1: TYPE INPUT)

1	2	3	4	5	Meaning
				•	Voltage-type input
			•		Current-type input
			•	•	Potentiometer-type input (POT)
		•			Thermocouple J-type input (TC J)
		•		•	Thermocouple K-type input (TC K)
		•	•		Thermocouple R-type input (TC R)
		•	•	•	Thermocouple S-type input (TC S)
	•				Thermocouple T-type input (TC T)
	•			•	Thermocouple B-type input (TC B)
	•		•		Thermocouple E-type input (TC E)
	•		•	•	Thermocouple N-type input (TC N)
	•	•			PT100 (RTD)-type input: 2 wires connection
	•	•		•	PT100 (RTD)-type input: 3 wires connection
	•	•	•		PT100 (RTD)-type input: 4 wires connection
	•	•	•	•	NI100 (RTD)-type input: 2 wires connection
•					Ni100 (RTD)-type input: 3 wires connection
•				•	Ni100 (RTD)-type input: 4 wires connection
•			•		PT500 (RTD)-type input: 2 wires connection
•			•	•	PT500 (RTD)-type input: 3 wires connection
•		•			PT500 (RTD)-type input: 4 wires connection
•		•		•	PT1000 (RTD)-type input: 2 wires connection
•		•	•		PT1000 (RTD)-type input: 3 wires connection
•		•	•	•	PT1000 (RTD)-type input: 4 wires connection

Table 2 - OUTPUT 1 AND 2 TYPE (Dip-Switches SW2: TYPE OUTPUT)

1	2	3	4	5	Meaning
		X	X	X	Voltage-type output 1: 0 – 10 V
	•	X	X	X	Voltage-type output 1: 0 – 5 V
•		X	X	X	Current-type output 1: 0 – 20 mA
•	•	X	X	X	Current-type output 1: 4 – 20 mA
X	X			X	Voltage-type output 2: 0 – 10 V
X	X		•		Voltage-type output 2: 0 – 5 V
X	X	•			Current-type output 2: 0 – 20 mA
X	X	•	•		Current-type output 2: 4 – 20 mA
X	X	X	X		If current-type output: active current
X	X	X	X	•	If current-type output: passive current

SW1			Table 3 - START-SCALE VALUES FOR SELECTED INPUT TYPE							
6	7	8	Voltage	Current	POT	TC J	TC K	TC R	TC S	TC T
		•	0 V	0 mA	0%	-200 °C	-200 °C	0 °C	0 °C	-200 °C
		•	0.5 V	1 mA	10%	-100 °C	-100 °C	100 °C	100 °C	-100 °C
		• •	1 V	2 mA	20%	0 °C	0 °C	200 °C	200 °C	-50 °C
•			2 V	3 mA	30%	100 °C	100 °C	300 °C	300 °C	0 °C
•		•	4 V	4 mA	40%	200 °C	200 °C	400 °C	400 °C	50 °C
•	•		5 V	5 mA	50%	300 °C	300 °C	600 °C	600 °C	100 °C
•	•	•	10 V	10 mA	60%	500 °C	500 °C	800 °C	800 °C	150 °C

SW1			Table 3 - START-SCALE VALUES FOR SELECTED INPUT TYPE						
6	7	8	TC B (*)	TC E	TC N	PT100	NI100	PT500	PT1000
		•	0 °C	-200 °C	-200 °C	-200 °C	-50 °C	-200 °C	-200 °C
		•	500 °C	-100 °C	-100 °C	-100 °C	-30 °C	-100 °C	-100 °C
		• •	600 °C	0 °C	0 °C	-50 °C	-20 °C	-50 °C	-50 °C
•			700 °C	100 °C	100 °C	0 °C	0 °C	0 °C	0 °C
•		•	800 °C	150 °C	200 °C	50 °C	20 °C	50 °C	50 °C
•	•		1000 °C	200 °C	300 °C	100 °C	30 °C	100 °C	100 °C
•	•	•	1200 °C	400 °C	500 °C	200 °C	50 °C	200 °C	200 °C

SW2			Table 4 - END-SCALE VALUES FOR SELECTED INPUT TYPE							
6	7	8	Voltage	Current	POT	TC J	TC K	TC R	TC S	TC T
		•	0.5 V	1 mA	40%	100 °C	200 °C	400 °C	400 °C	50 °C
		•	1 V	2 mA	50%	200 °C	400 °C	600 °C	600 °C	100 °C
		• •	2 V	3 mA	60%	300 °C	600 °C	800 °C	800 °C	150 °C
•			3 V	4 mA	70%	400 °C	800 °C	1000 °C	1000 °C	200 °C
•		•	4 V	5 mA	80%	500 °C	1000 °C	1200 °C	1200 °C	250 °C
•	•		5 V	10 mA	90%	800 °C	1200 °C	1400 °C	1400 °C	300 °C
•	•	•	10 V	20 mA	100%	1000 °C	1300 °C	1750 °C	1750 °C	400 °C

SW2			Table 4 - END-SCALE VALUES FOR SELECTED INPUT TYPE						
6	7	8	TC B	TC E	TC N	PT100	NI100	PT500	PT1000
		•	500 °C	50 °C	200 °C	50 °C	20 °C	0 °C	0 °C
		•	600 °C	100 °C	400 °C	100 °C	40 °C	50 °C	50 °C
		• •	800 °C	200 °C	600 °C	200 °C	50 °C	100 °C	100 °C
•			1000 °C	300 °C	800 °C	300 °C	80 °C	150 °C	150 °C
•		•	1200 °C	400 °C	1000 °C	400 °C	100 °C	200 °C	200 °C
•	•		1500 °C	600 °C	1200 °C	500 °C	150 °C	300 °C	300 °C
•	•	•	1800 °C	800 °C	1300 °C	600 °C	200 °C	400 °C	400 °C

(*) Output zero if t < 250 °C



Power off the module before configuring it by Dip-Switches to avoid serious damage due to electrostatic discharges.

7.3 DEFAULT CONFIGURATION

The default configuration for the setting parameters is shown in the following table (if configuration modality by software).

Input type	Current
Input filter	Deactivated
Input Start-scale/End-scale	0 [mA]/20 [mA]
Output 1 type/Output 2 type	Active current
Output 1 and 2 Start-scale	0 [mA]
Output 1 and 2 End-scale	20 [mA]
Output 1 and 2 Limiters	Deactivated
Limit inferior for Output 1 and 2 Limiters	0 [mA]
Limit superior for Output 1 and 2 Limiters	20 [mA]
Network frequency Rejection/sampling	Deactivated/sampling time = 5 ms
Cold Junction compensation (for TC-type input)	Deactivated
Detection of input fail: over-scala input error (if voltage, current, potentiometer-type) or burn-out error(if TC, RTD-type)/Fault values	Deactivated/Fault values = 0 [mA]



Active current means output already powered on, needs to be connected to the passive module.

The default configuration for the setting parameters is shown in the following table (if configuration modality by Dip-Switches).

Input filter	Deactivated
Output 1 and 2 Limiters	Deactivated (only if current-type output 4 – 20 mA: limiter is activated; limit inferior-superior of output:3.6 – 20.4 mA)
Network frequency Rejection/sampling	If IN=voltage, current, potentiometer: no rejection, sampling time = 5ms; if IN=TC, RTD: rejection = 50Hz, sampling time = 20ms
Cold Junction compensation (for TC-type input)	Activated
Detection of input fail: over-scala input error (if voltage, current, potentiometer-type) or burn-out error(if TC, RTD-type)/Fault values	If IN=voltage, current, potentiometer: deactivated; if IN=TC, RTD: activated, Fault values=output end scale +5 % of output scala range



The values of setting parameters configured by Dip-Switches modality has priority over the values stored in memory EEPROM.

If you want change any of the parameters then you can find software and applications in the download area of the website www.seneca.it.

8. DECOMMISSIONING AND DISPOSAL



Disposal of Electrical & Electronic Equipment (Applicable throughout the European Union and other European countries with separate collections programs). This symbol, found on your product or on its packaging, indicates that this product should not be treated as household waste when you wish to dispose of it. Instead, it should be handed over to an applicable collection point for the recycling of electrical & electronic equipment. By ensuring this product is disposed of correctly, you will help prevent potential negative consequences to the environment and human health, which could otherwise be caused by inappropriate disposal of this product. The recycling of materials will help to conserve natural resources. For more detailed information about the recycling of the product, please contact your local city office, waste disposal service of the retail store where you purchased this product.

9. PURCHASE ORDER CODE

Order code	Specification
Z170REG	DC universal duplicator / isolator
CU-A-MICROB	1 mt USB-microUSB communication cable
CU-A-MICRO-OTG	Mobile phone adapter

10. MODULE LAYOUT

10.1 MODULE LAYOUT AND SIGNALLING LEDES

MODULE DIMENSIONS	FRONT-SIDE PANEL
<p>112 mm</p> <p>100,0 mm</p> <p>17,5 mm</p>	<p>1 2 3 4 5 6</p> <p>S</p> <p>(X) PWR (X) FAIL</p> <p>Y USB</p> <p>Z170REG</p> <p>7 8 9 10 11 12</p>



In the front-side panel there are 2 LEDs and their state refers to important operating conditions of the module (figure 4).

LED	LED state	Meaning
PWR	Turned on (green light)	The module power is on
FAIL	Turned on (yellow light)	There is an error status
	Turned off	There isn't an error status

If there is an «error status» then the module has at least one of the following errors:

Tipo di errore	Descrizione	Tipo di ingresso interessato
Input error	The amplitude of the acquired input signal is less than (greater than) the input start scale (end scale) or the TC/RTD sensor is damaged	Voltage, current, potentiometer, thermocouple, thermoresistance
Loss of data error /	/	All
Input temperature-acquired error	The cold-junction internal sensor is damaged	Thermocouple

If the amplitude of the acquired input signal IN is between the input start scale and input end scale, the output is directly proportional to the input.

If the amplitude of the acquired input signal IN exceeds the interval [input start scale - 2.5 % of input scala range, input end scale + 2.5 % of input scala range], the LED FAIL switches from turned off to turned on and the software signals that there is a input error.

If the amplitude of the acquired input signal IN decreases into the interval [input start scale - 2.5 % of input scala range, input end scale + 2.5 % of input scala range], the LED FAIL switches from turned on to turned off and the software signals that there isn't a input error.

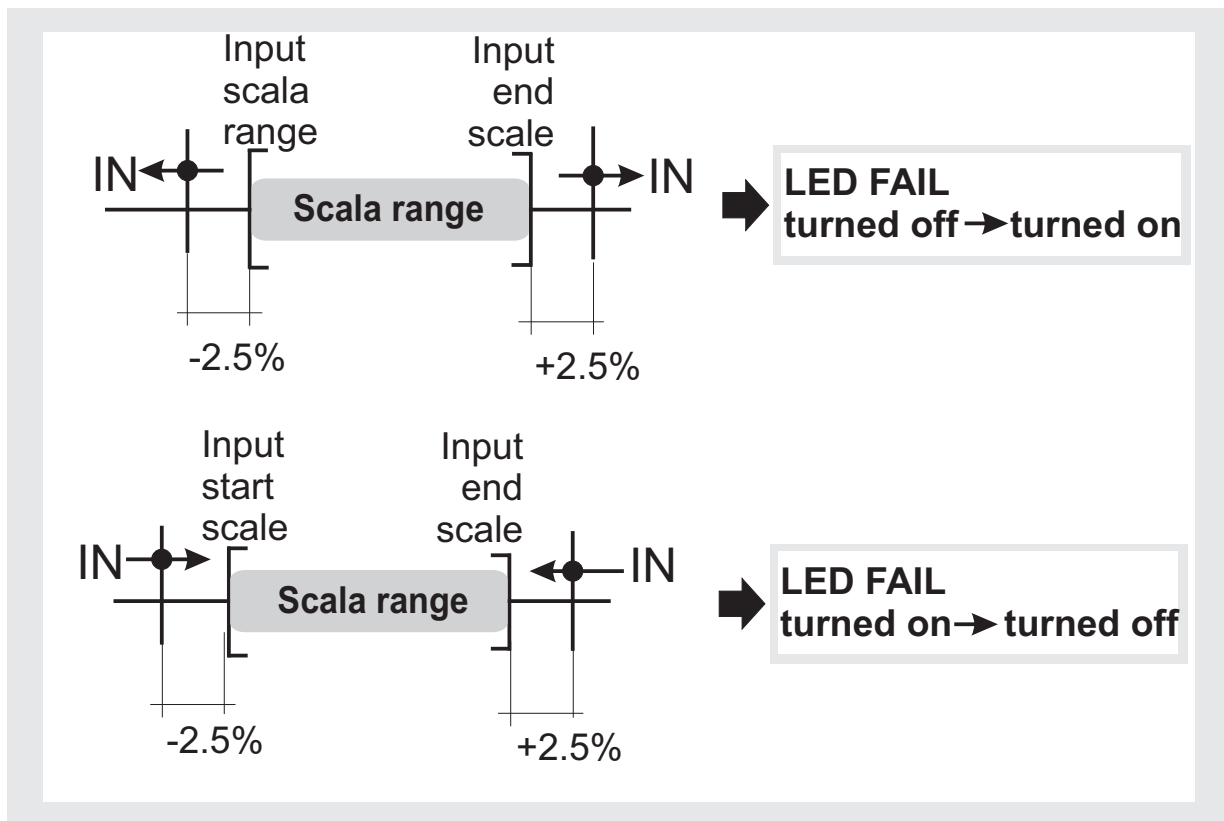

If the amplitude of the acquired input signal IN exceeds the hardware module limits too (see the following table), the software will also signal that there is a error fail.

Input type	Module hardware limits
Voltage	0 V; 10.5 V
Current	0 mA; 21 mA
Potentiometer	0; 100 %
Thermocouple mV	If TC J: -210°C; 1200°C. If TC K: -270°C; 1370°C. If TC R: -50°C; 1760°C. If TC S: -50°C; 1760°C. If TC T: -270°C; 400°C. If TC B: 0; 1820°C. If TC E: -270°C; 1000°C. If TC N: -270°C; 1300°C IF mV: -10mV; 70mV.
Thermoresistance	If RTD=NI100: -60°C; 250°C If RTD=PT100, RTD=PT500, RTD=PT1000: -200°C; 600°C

If the LED FAIL is turned on (there is a fail error) and if detection of input fail is activated, the module overwrites the outputs with «Fault values».

10.2 BLOCK DIAGRAM

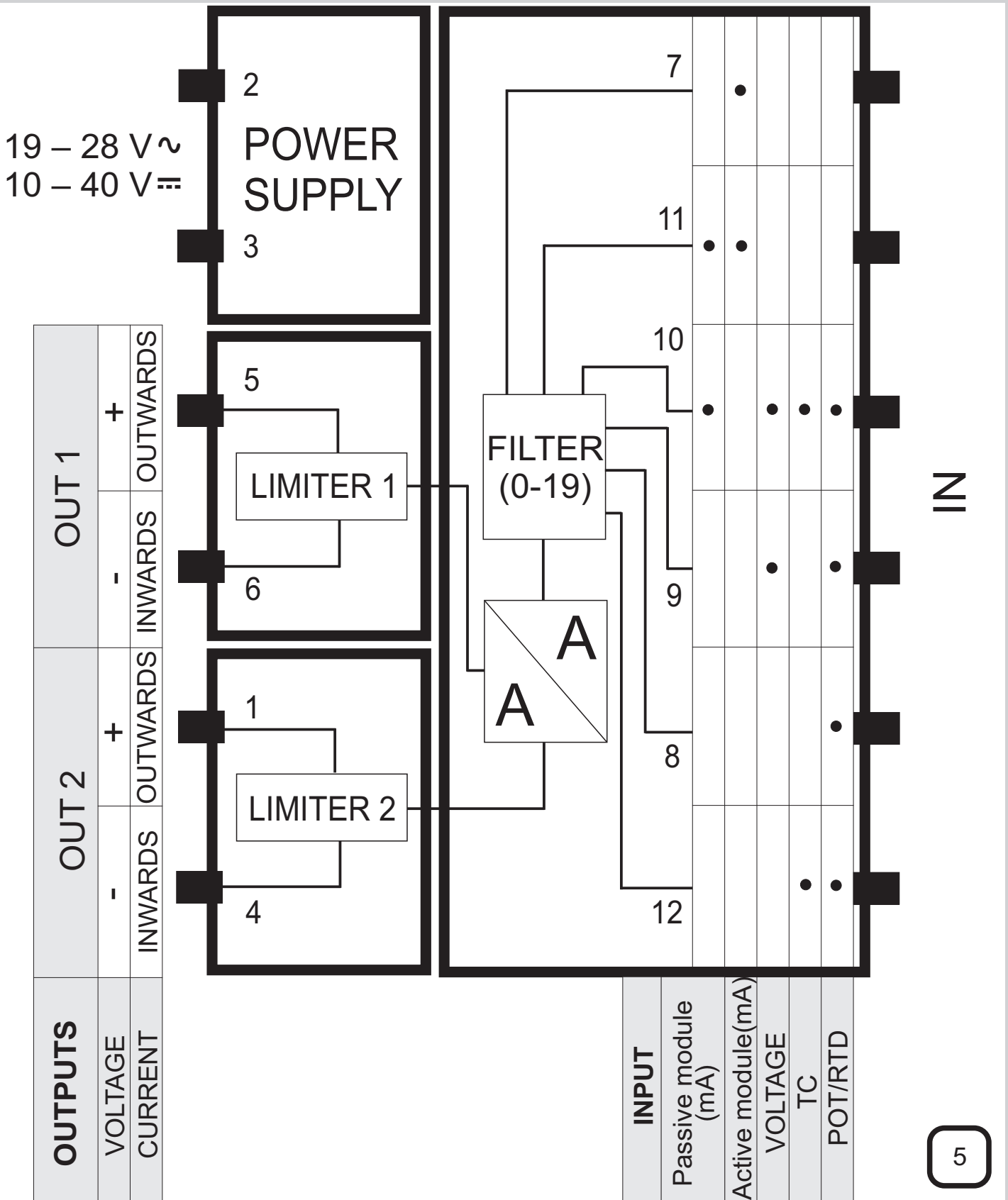

Block	Block meaning (figure 5)
FILTER (0-19)	20-levels filter, which an input-acquired signal is applied
A/A	Analog to Analog Converter
LIMITER 1, 2	Signal-amplitude limiters for Output 1, 2

This page intentionally left blank.

This page intentionally left blank.

This page intentionally left blank.