



Z102

Ohm / mA-V CONVERTER WITH GALVANIC SEPARATION

GENERAL CHARACTERISTICS

- input for resistance measurement with connection to rheostat (2 wires) and potentiometer (3 wires);
- front panel with ZERO and SPAN trimmers.
- insulated analogue output in current (with active or passive connection) and in voltage.
- front panel with power ON indicator.
- 3-point insulation: 1500Vac.

TECHNICAL FEATURES

Power supply:	19 - 40 Vdc, 19-28 Vac 50-60Hz, max 2.5W.			
Input:	- Resistance with connection to rheostat (2 wires), ranges 0 - 300 ohms (I = 6 mA), 0 - 500 ohms (I = 3.6 mA) and 0 - 1 Kohm (I = 1.8 mA). - Resistance with connection to potentiometer (3 wires) (Vref = 1.8 Vdc).			
Output:	Output current 0-20mA or 4-20mA, loop impedance <600ohm Voltage 0-5V, 1-5V, 0-10V and 2-10V load impedance >2Kohms.			
Environmental conditions:	Temperature: 0..50°C, Humidity min:30%, max 90% at 40°C not condensing (see also section How to install).			
Errors referred to the input's range of measurement:	Setting error	Temperature coefficient	Linearity error	Other
	0,2%	0,02%/°C	0,05%	
Output/power supply protection:	against impulse overvoltage 400W/ms.			
Standards:	The instrument conforms to the following standards: EN50081-2 (electromagnetic emissions, industrial environment) EN50082-2 (electromagnetic immunity, industrial environment) EN61010-1 (safety)			



ELECTRICAL CONNECTIONS

POWER SUPPLY

19-40Vdc

19-28Vac

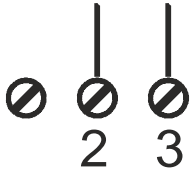

Power voltage must be in a range from 19 to 40 Vdc (indifferent polarity), from 19 to 28 Vac; see also section **INSTALLATION NORMS**.

Upper limits must not be exceeded, if it happen there could be damages for module.

It is necessary to protect power source from possible module's failure by fuse correctly dimensioned.

INPUT

Connection to rheostat (2 wires)

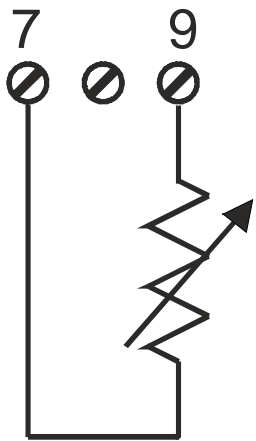

0-300 ohm



0-500 ohm



0-1 Kohm

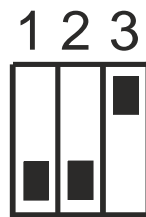

Connection to potentiometer (3 wires)

(for potentiometers in the range 200 ohms to 1Mohm)

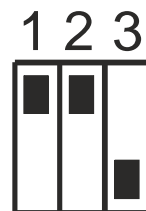
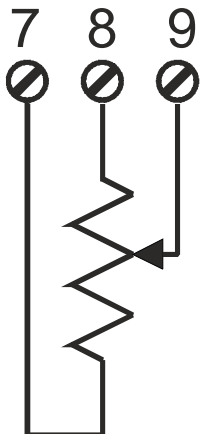

OUTPUT

CURRENT
ACTIVE Output

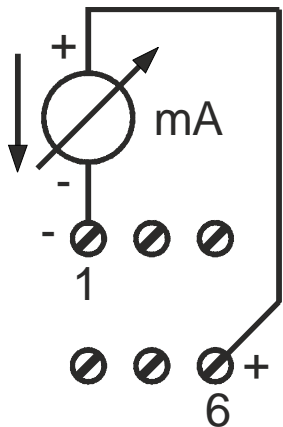

CURRENT
PASSIVE Output

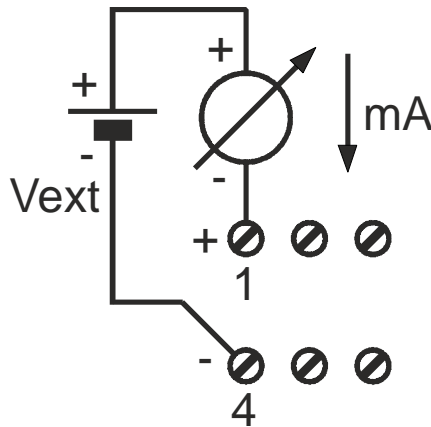

VOLTAGE

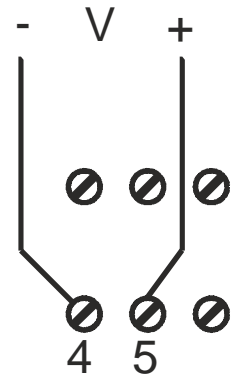

For the output in current, the **ACTIVE** connection must be used when the output loop is to be powered directly by the Z102 module, whilst the **PASSIVE** connection must be used in the event the power supply of the current loop comes from an independent source.

The Z102 module can operate a maximum load of 600 ohms on the loop, with the loop power supply protected against short-circuiting.

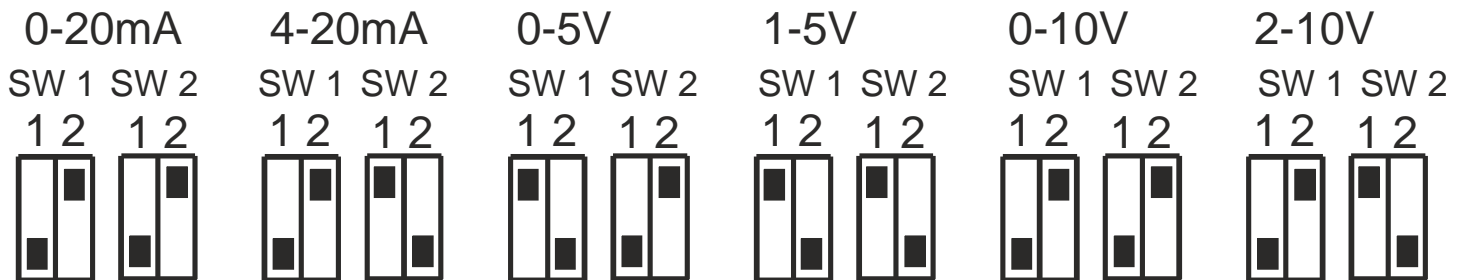

HOW TO INSTALL

Z102 module is designed to be mounted on a DIN 46277 bar, in vertical position.

To obtain an optimal working and duration, it is necessary to assure an adequate ventilation to modules, avoiding to place raceways or other objects that can close abat-vents.

Avoid to mount modules over devices that generate heat; we suggest to mount devices in the lower side of the panel.

HEAVY WORKING CONDITIONS:

Heavy working conditions are:

- *High power voltage a (> 30Vdc / > 26 Vac).*
- *Input sensor feeded.*
- *Use of output in impressed current.*

When modules are put side by side it s possible that it is **necessary to separate them at least 5 mm** in the following cases:

- Upper board temperature higher than 45°C and at least one of the heavy working conditions verified.
- Upper board temperature higher than 35°C and at least two of the heavy working temperature verified.

ELECTRICAL CONNECTIONS

We recommand to use shielded cables to do signals connection; monitor must be connected to a preferential ground for devices. Besides it is a good rool avoid to pass wires near power installation cables like inverters, motors, induction furnaces etc.



Disposal of Electrical & Electronic Equipment (Applicable throughout the European Union and other European countries with separate collection programs)

This symbol, found on your product or on its packaging, indicates that this product should not be treated as household waste when you wish to dispose of it. Instead, it should be handed over to an applicable collection point for the recycling of electrical and electronic equipment. By ensuring this product is disposed of correctly, you will help prevent potential negative consequences to the environment and human health, which could otherwise be caused by inappropriate disposal of this product. The recycling of materials will help to conserve natural resources. For more detailed information about the recycling of this product, please contact your local city office, waste disposal service or the retail store where you purchased this product.

This document is property of SENECA srl. Duplication and reproduction are forbidden, if not authorized. Contents of the present documentation refers to products and technologies described in it. All technical data contained in the document may be modified without prior notice Content of this documentation is subject to periodical revision.



SENECA s.r.l.

Via Austria, 26 - 35127 - PADOVA - ITALY

Tel. +39.049.8705355 - 8705359 - Fax +39.049.8706287

e-mail: info@seneca.it - www.seneca.it