

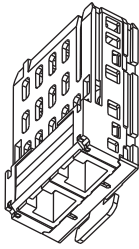

S1A4559110

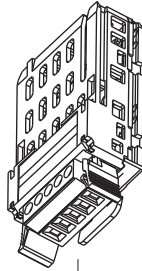

VW3A3601 / VW3A3608  
VW3A3616 / VW3A3627  
VW3A3619



VW3A3609  
VW3A3628  
VW3A3725  
VW3M3301

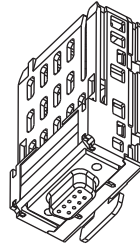

VW3A3607  
VW3A3618

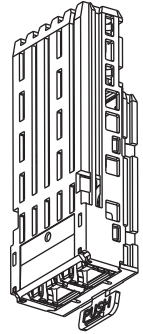

VW3A3720  
VW3A3721  
VW3M3308  
VW3A3530D

**⚡ ⚠ DANGER**

**HAZARD OF ELECTRIC SHOCK, EXPLOSION, OR ARC FLASH**

- Only appropriately trained persons who are familiar with and fully understand the contents of the present manual and all other pertinent product documentation and who have received all necessary training to recognize and avoid hazards involved are authorized to work on and with this drive system.
- Installation, adjustment, repair and maintenance must be performed by qualified personnel.
- Verify compliance with all local and national electrical code requirements as well as all other applicable regulations with respect to grounding of all equipment.
- Only use properly rated, electrically insulated tools and measuring equipment.
- Do not touch unshielded components or terminals with voltage present.
- Prior to performing any type of work on the drive system, block the motor shaft to prevent rotation.
- Insulate both ends of unused conductors of the motor cable.
- Do not short across the DC bus terminals or the DC bus capacitors or the braking resistor terminals.
- Before performing work on the drive system:
  - Disconnect all power, including external control power that may be present.
  - Place a "Do Not Turn On" label on all power switches.
  - Lock all power switches in the open position.
  - Wait 15 minutes to allow the DC bus capacitors to discharge. The DC bus LED is not an indicator of the absence of DC bus voltage that can exceed 800 Vdc.
  - Measure the voltage on the DC bus between the DC bus terminals (PA/+ and PC/-) using a properly rated voltmeter to verify that the voltage is <42 Vdc.
  - If the DC bus capacitors do not discharge properly, contact your local Schneider Electric representative. Do not repair or operate the product.
- Before applying voltage to the drive system:
  - Verify that the work has been completed and that the entire installation cannot cause hazards.
  - If the mains input terminals and the motor output terminals have been grounded and short-circuited, remove the ground and the short circuits on the mains input terminals and the motor output terminals.
  - Verify proper grounding of all equipment.
  - Verify that all protective equipment such as covers, doors, grids is installed and/or closed.

**Failure to follow these instructions will result in death or serious injury.**

Electrical equipment should be installed, operated, serviced, and maintained only by qualified personnel. No responsibility is assumed by Schneider Electric for any consequences arising out of the use of this product.

© 2019 Schneider Electric. All Rights Reserved.

Option Module		Altivar Machine			Altivar Process		Altivar Soft Starter	Lexium	MV Drive
		ATV32	ATV320	ATV340 <sup>(1)</sup>	ATV600 <sup>(2)</sup>	ATV900	ATS480	LXM32	ATV6000
		Device version $\geq$ (Option Module version $\geq$ )							
VW3A3601	EtherCAT	V1.2IE03 (V1.1IE08)	V2.7IE23 (V1.9IE09)	V1.1IE02 (V1.11IE01)		V1.2IE02 (V1.8IE05)		V1.4IE06 (V1.1IE08)	✓
VW3A3607	PROFIBUS DP	V1.1IE01 (V1.5IE01)	V2.7IE23 (V1.12IE01)	V1.1IE02 (V1.12IE01)	V1.1IE01 (V1.9IE01)	V1.1IE01 (V1.10IE01)	V1.1IE01 (V1.16IEXX)	V1.0IE03 (V1.3IE01)	✓
VW3A3608 VW3A3618 VW3A3628	CANopen	V1.2IE03 (V1.1IE01)	V2.7IE23 (V1.1IE01)	V1.1IE02 (V1.1IE01)	V1.1IE01 (V1.1IE01)	V1.1IE01 (V1.1IE01)	V1.1IE01 (V1.1IE01)	V1.0IE03 (✓)	✓
VW3A3609	DeviceNet	V1.1IE01 (V1.1IE01)	V2.7IE23 (V1.8IE01)	V1.1IE02 (V1.8IE01)	V1.1IE01 (V1.5IE05)	V1.1IE01 (V1.5IE05)			✓
VW3A3616	Ethernet TCP/IP	V1.1IE01 (V1.2IE01)	V2.7IE23 (V1.EIE01)					V1.0IE03 (V1.1IE31)	
VW3A3619	POWERLINK	V1.5IE08 (V1.0IE08)	V2.7IE23 (V1.0IE08)	V1.5IE10 (V1.1IE04)	V2.2IE24 (V1.1IE04)	V1.8IE14 (V1.1IE04)			
VW3A3627	PROFINET	V1.8IE11 (V1.0IE15)	V2.7IE23 (V1.6IE01)	V1.1IE02 (V1.6IE01)	V1.1IE01 (V1.3IE01)	V1.1IE01 (V1.3IE01)			✓
VW3A3720	Ethernet IP / Modbus TCP				V1.5IE11(3) (V1.8IE12)		V1.1IE01 (V1.15IEXX)		
VW3A3721	Ethernet IP / Modbus TCP + MultiDrive Link				V1.6IE12(3) (V1.8IE13)		V1.1IE01 (V1.15IEXX)		
VW3A3725	BACnet MS/TP				V1.7IE16 (V1.1IEXX)				
VW3M3301	DeviceNet							$\geq$ V1.0IE03 $\leq$ V1.20IE05 (V1.0)	
VW3M3308	PROFINET							V1.24IE03 (V1.0IE11)	
VW3A3530D	ATV dPAC Module			Upcoming commercialization, for the Altivar Firmware Version, contact your Schneider Electric Customer Care Center on <a href="http://www.se.com/CCC">www.se.com/CCC</a>					

- (1) Fieldbus modules can not be used on the ATV340••••N4S and ATV340••••N4E  $\leq$  22kW. For more information, see the ATV340 Installation Manual ([NVE61069](#)).  
(2) ATV610 is compatible only with VW3A3607 PROFIBUS DP fieldbus module.  
(3) Drive version  $\geq$  V2.2IE24 is only compatible with module version  $\geq$  V1.15IE18.

# ATV320 ATV32

## Mounting

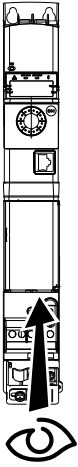

1)

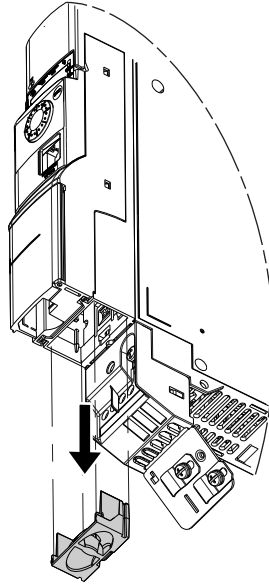

2)

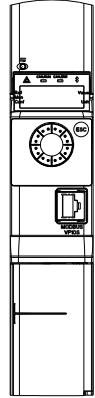

3)

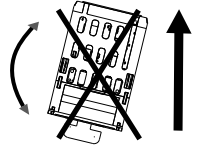
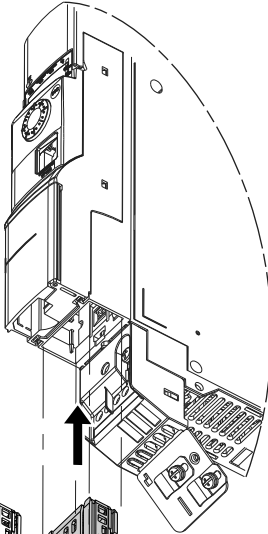
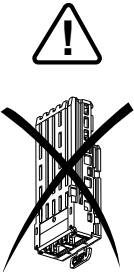

4)

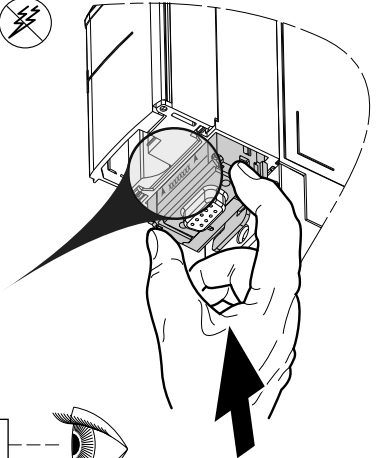

5)

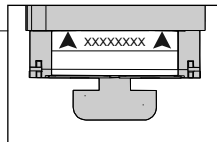
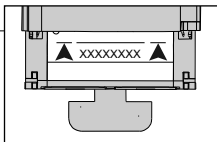

# ATV320 ATV32

Removing

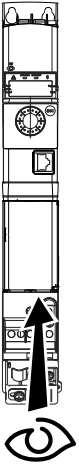

1) 

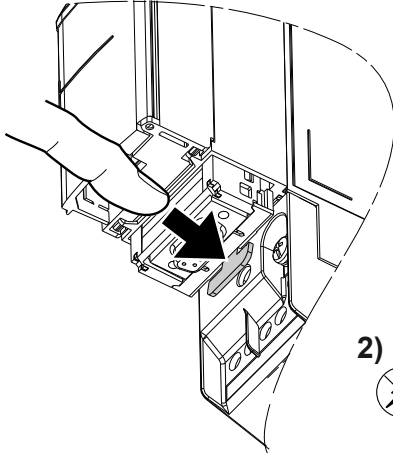

2) 

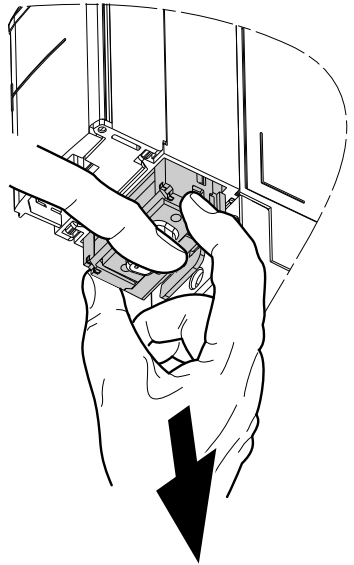

3) 

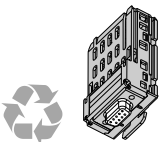
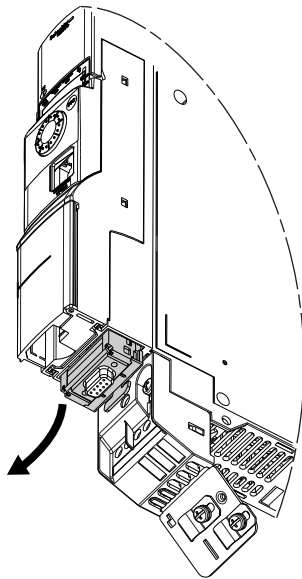



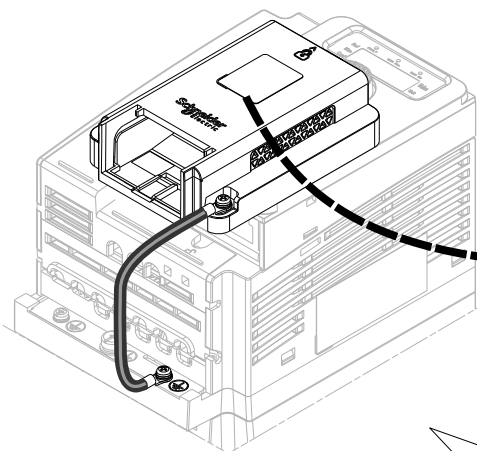

# ATV320

## Mounting



NVE22661



VW3A3600

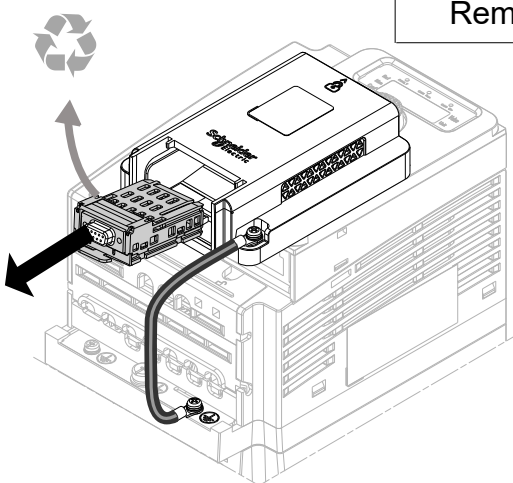
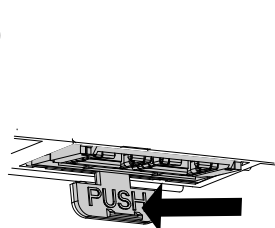
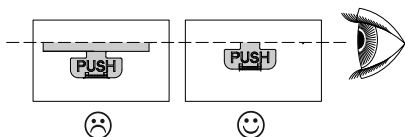
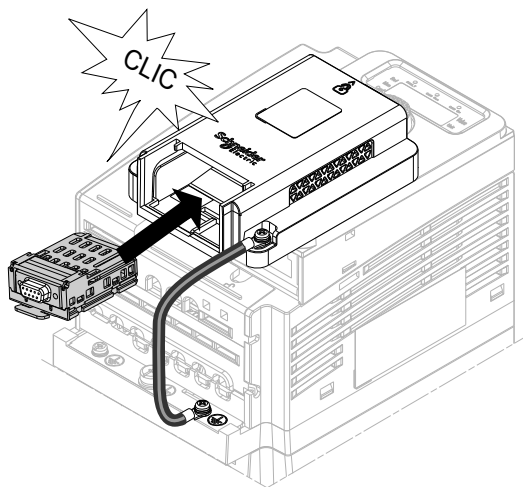
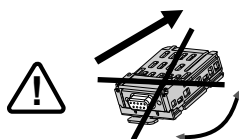





## Removing

# LXM32M ATV340

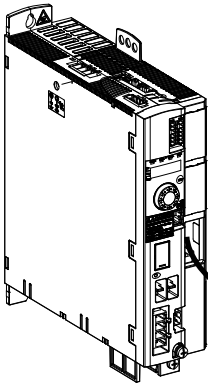
## Mounting



1 



Slot 1  ☹️  
 Slot 2  ☹️  
 Slot 3  😊

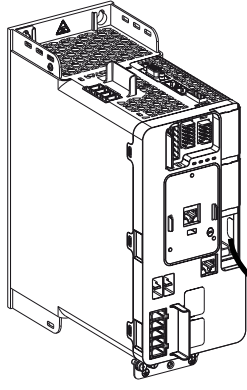



GP-SF  ☹️  
 GP-ENC  ☹️  
 GP-FB  😊

2 

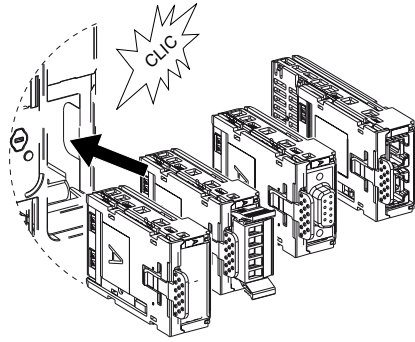
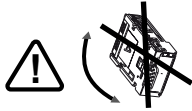

3 

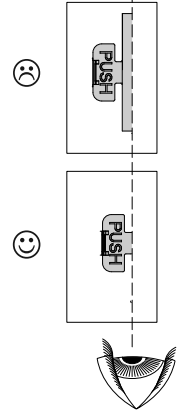

4 

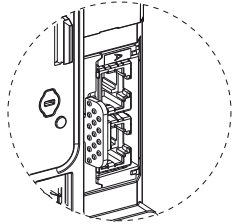

## Removing

1 

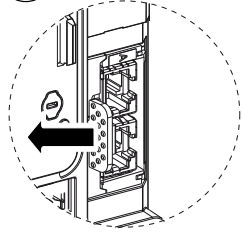

2 

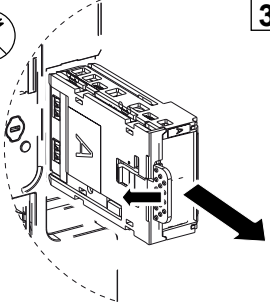

3 

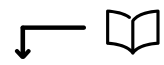
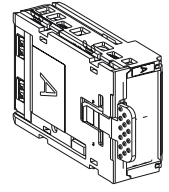



1)

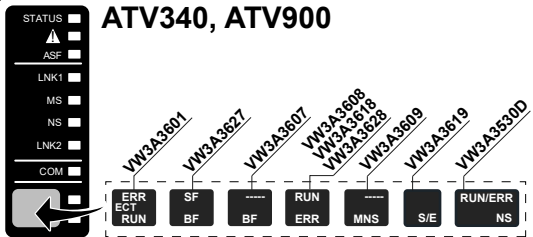
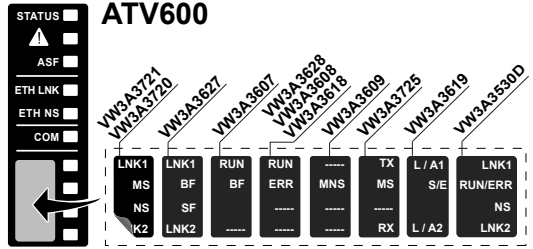
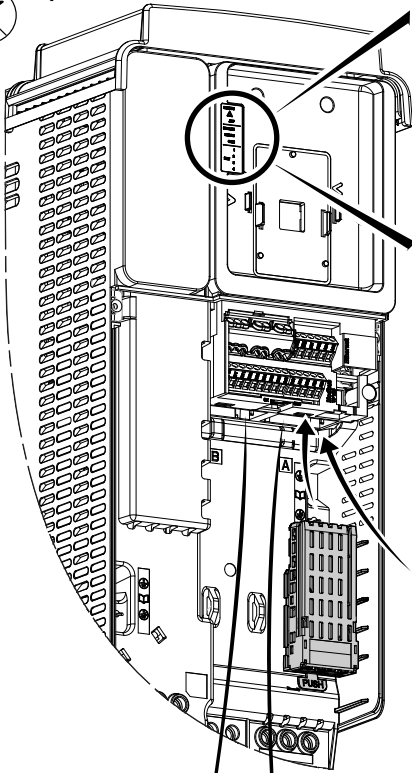

2)

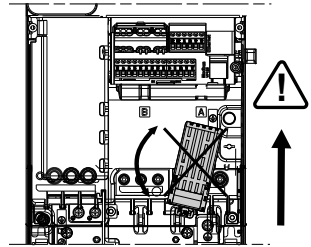

4)

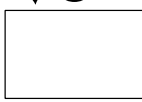
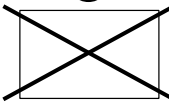

3)

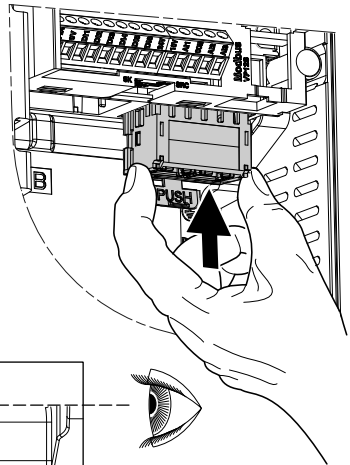

5)

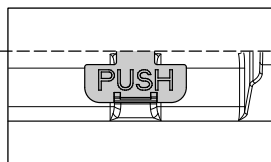
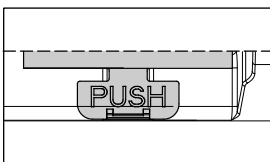

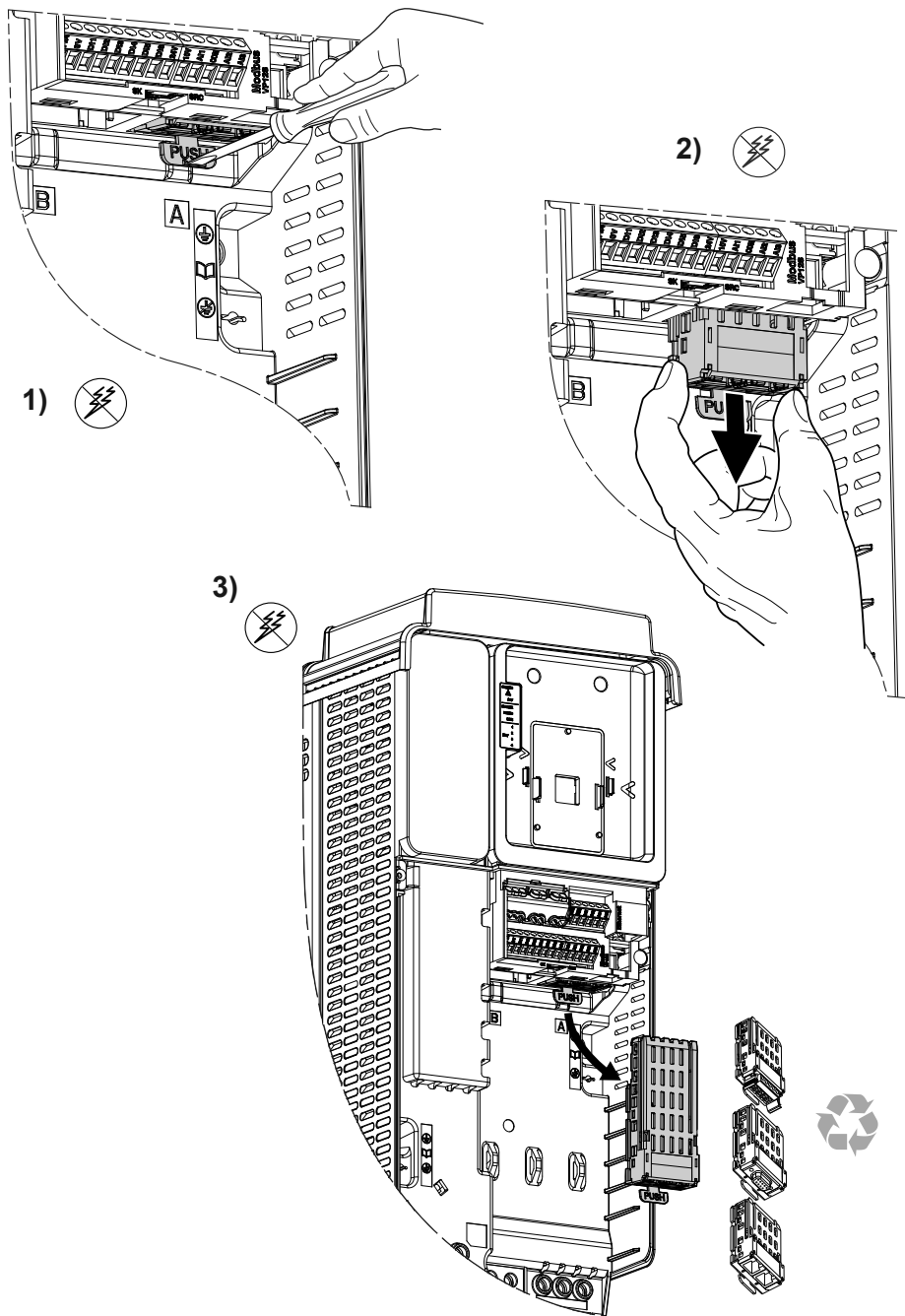



**ATS480**

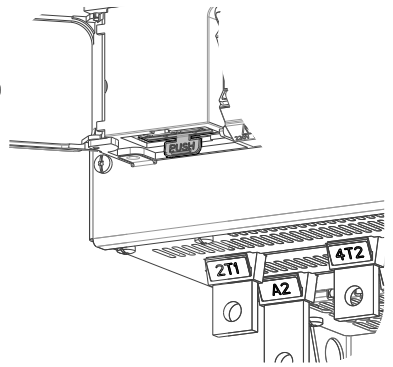
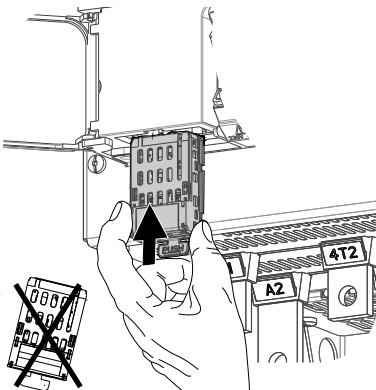
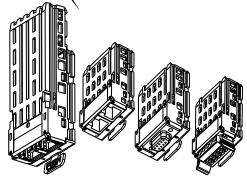
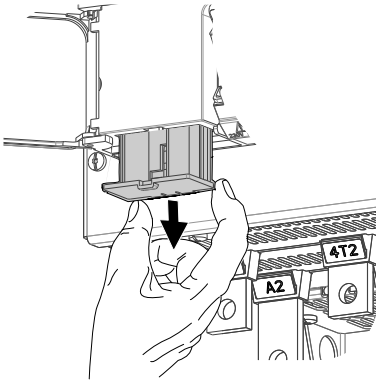
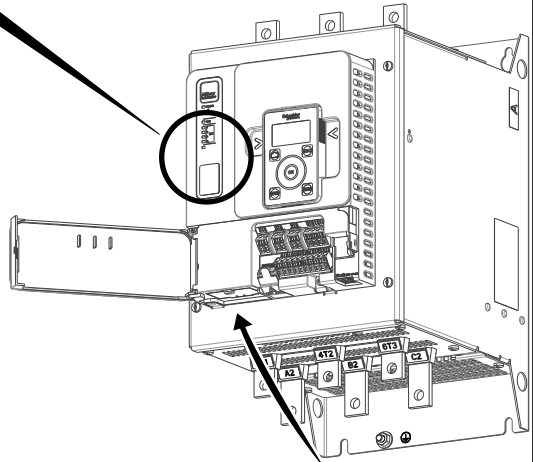
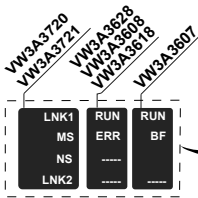

5)

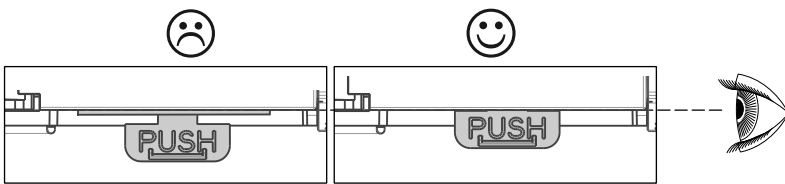

1)

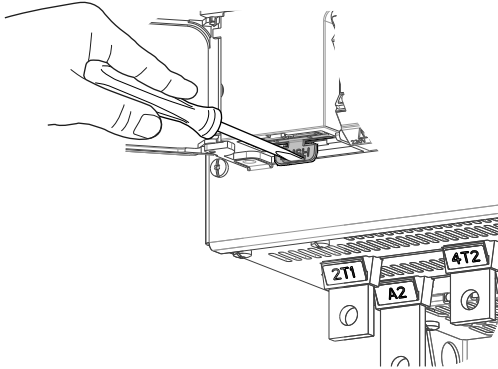

2)

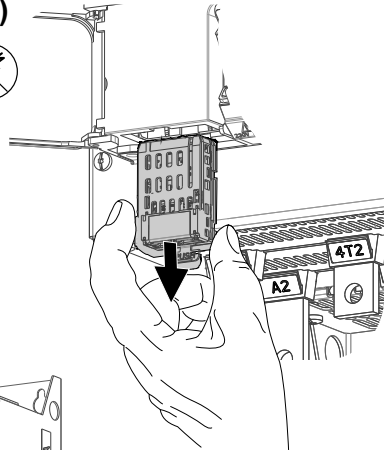

3)

