

# EasyLogic™ DM6000H / DM6200H series

## User manual

QGH1315603-05  
05/2022



# Legal Information

The Schneider Electric brand and any trademarks of Schneider Electric SE and its subsidiaries referred to in this guide are the property of Schneider Electric SE or its subsidiaries. All other brands may be trademarks of their respective owners.

This guide and its content are protected under applicable copyright laws and furnished for informational use only. No part of this guide may be reproduced or transmitted in any form or by any means (electronic, mechanical, photocopying, recording, or otherwise), for any purpose, without the prior written permission of Schneider Electric.

Schneider Electric does not grant any right or license for commercial use of the guide or its content, except for a non-exclusive and personal license to consult it on an "as is" basis. Schneider Electric products and equipment should be installed, operated, serviced, and maintained only by qualified personnel.

As standards, specifications, and designs change from time to time, information contained in this guide may be subject to change without notice.

To the extent permitted by applicable law, no responsibility or liability is assumed by Schneider Electric and its subsidiaries for any errors or omissions in the informational content of this material or consequences arising out of or resulting from the use of the information contained herein.

# Safety information

## Important information

Read these instructions carefully and look at the equipment to become familiar with the device before trying to install, operate, service, or maintain it. The following special messages may appear throughout this manual or on the equipment to warn of potential hazards or to call attention to information that clarifies or simplifies a procedure.



The addition of either symbol to a “Danger” or “Warning” safety label indicates that an electrical hazard exists which will result in personal injury if the instructions are not followed.



This is the safety alert symbol. It is used to alert you to potential personal injury hazards. Obey all safety messages that accompany this symbol to avoid possible injury or death.

### DANGER

**DANGER** indicates a hazardous situation which, if not avoided, **will result in death or serious injury**.

**Failure to follow these instructions will result in death or serious injury.**

### WARNING

**WARNING** indicates a hazardous situation which, if not avoided, **could result in death or serious injury**.

### CAUTION

**CAUTION** indicates a hazardous situation which, if not avoided, **could result in minor or moderate injury**.

### NOTICE

NOTICE is used to address practices not related to physical injury.

## Please note

Electrical equipment should be installed, operated, serviced and maintained only by qualified personnel. No responsibility is assumed by Schneider Electric for any consequences arising out of the use of this material. A qualified person is one who has skills and knowledge related to the construction, installation, and operation of electrical equipment and has received safety training to recognize and avoid the hazards involved.

## Notice

### FCC

This equipment has been tested and found to comply with the limits for a Class A digital device, pursuant to Part 15 of the FCC rules. These limits are designed to provide reasonable protection against harmful interference when the equipment is operated in a commercial environment. This equipment generates, uses, and can radiate radio frequency energy and, if not installed and used in accordance with the instruction manual, may cause harmful interference to radio communications. Operation of this equipment in a residential area is likely to cause harmful interference in which case the user will be required to correct the interference at his own expense.

The user is cautioned that any changes or modifications not expressly approved by Schneider Electric could void the user's authority to operate the equipment.

This digital apparatus complies with CAN ICES-3 (A) /NMB-3(A).

# Table of Contents

Safety precautions .....	7
Introduction .....	8
Meter overview .....	8
Meter features .....	8
Applications .....	8
Main characteristics .....	9
Feature summary .....	9
Measured parameters .....	10
Instantaneous .....	10
Data display and analysis tools .....	10
Meter configuration .....	11
Hardware reference .....	12
Meter types .....	12
Supplemental information .....	12
Physical description .....	12
Front panel .....	12
Analog load bar .....	13
Smart keys .....	14
Panel meter .....	15
Protective cover .....	16
Meter mounting .....	16
Meter wiring .....	17
Direct connect voltage limits Measuring voltage limit .....	17
Balanced system considerations .....	17
Serial communications .....	17
RS-485 configuration .....	17
Serial protocols .....	18
RS-485 wiring .....	18
RS-485 network configuration .....	18
Display and meter setup .....	19
Display overview .....	19
Heartbeat / serial communications LED .....	19
Meter screen menus .....	20
Viewing parameters .....	20
Display screen menu tree .....	20
Button functions in viewing parameters .....	21
Setup screen menus .....	21
Setup parameters .....	22
Button functions in viewing setup parameters .....	23
Button functions in editing setup parameters .....	23
Editing setup parameters .....	23
Communications setup .....	24
Password setup .....	24
Diagnostics (Diag) screen menus .....	25
Lock / unlock .....	27
Security .....	28
Security overview .....	28

Security features on your device .....	28
Passwords and user accounts .....	28
Remote meter setup .....	29
Overview .....	29
ION setup .....	29
RS-485 port setup .....	29
Meter setup through RS-485 .....	29
Using a serial communications converter to set up RS-485 .....	29
Meter configuration using ION Setup .....	30
Viewing meter data .....	31
Overview .....	31
RMS page .....	31
Diag page .....	31
Using ION Setup to view or modify configuration data .....	32
Using software to view meter data .....	32
Power Monitoring Expert .....	32
Power SCADA Operation .....	33
Modbus command interface .....	33
Measurements and calculations .....	34
Meter initialization .....	34
Real-time readings .....	34
Timer .....	34
Meter on hours .....	34
Power Interruptions .....	34
Maintenance and upgrades .....	35
Maintenance overview .....	35
Troubleshooting LED indicators .....	35
Meter memory .....	35
Firmware version, model, and serial number .....	35
Firmware upgrades .....	36
Firmware upgrade using DLF3000 .....	36
Technical assistance .....	37
Verifying accuracy .....	38
Overview of meter accuracy .....	38
Accuracy test requirements .....	38
Verifying accuracy test .....	39
Percentage error calculation for accuracy verification testing .....	40
Typical sources of test errors .....	40
Power factor .....	41
Current phase shift from voltage .....	41
Power factor (PF) .....	41
Power factor sign convention .....	42
Power factor register format .....	42
Command interface .....	45
Command interface .....	45
Using protected command interface .....	45
Specifications .....	47
Device specifications .....	47
China Standard Compliance .....	51

# Safety precautions

Installation, wiring, testing and service must be performed in accordance with all local and national electrical codes.

<b>⚠️⚠️ DANGER</b>
<b>HAZARD OF ELECTRIC SHOCK, EXPLOSION, OR ARC FLASH</b>
<ul style="list-style-type: none"><li>• Apply appropriate Personal Protective Equipment (PPE) and follow safe electrical work practices. See NFPA 70E, CSA Z462 or other local standards.</li><li>• Turn off all power supplying this device and the equipment in which it is installed before working on or in the equipment.</li><li>• Always use a properly rated voltage sensing device to confirm that all power is off.</li><li>• Follow guidelines in the Wiring section of the related Installation Sheet.</li><li>• Assume communications and I/O wiring are hazardous live until determined otherwise.</li><li>• Do not exceed the maximum ratings of this device.</li><li>• Do not short secondary terminals of Voltage Transformer (VT).</li><li>• Do not open secondary terminals of Current Transformer (CT).</li><li>• Ground secondary circuit of CTs.</li><li>• Do not use the data from the meter to confirm power is off.</li><li>• Replace all devices, doors and covers before turning on power to this equipment.</li></ul>
<b>Failure to follow these instructions will result in death or serious injury.</b>

**NOTE:** See IEC 60950-1 for more information on communications and I/O wiring connected to multiple devices.

<b>⚠️ WARNING</b>
<b>UNINTENDED OPERATION</b>
<ul style="list-style-type: none"><li>• Do not use this device for critical control or protection of persons, animals, property or equipment.</li></ul>
<b>Failure to follow these instructions can result in death, serious injury, or equipment damage.</b>

<b>⚠️ WARNING</b>
<b>POTENTIAL COMPROMISE OF SYSTEM AVAILABILITY, INTEGRITY, AND CONFIDENTIALITY</b>
<ul style="list-style-type: none"><li>• Change default passwords/passcodes to help prevent unauthorized access to device settings and information.</li><li>• Disable unused ports/services and default accounts, where possible, to minimize pathways for malicious attacks.</li><li>• Place networked devices behind multiple layers of cyber defenses (such as firewalls, network segmentation, and network intrusion detection and protection).</li><li>• Use cybersecurity best practices (for example: least privilege, separation of duties) to help prevent unauthorized exposure, loss, modification of data and logs, interruption of services, or unintended operation.</li></ul>
<b>Failure to follow these instructions can result in death, serious injury, or equipment damage.</b>

# Introduction

## Meter overview

The DM6000H / DM6200H series meters offer comprehensive 3-phase electrical instrumentation and load management facilities in a compact and rugged package.

The DM6000H / DM6200H meters offer value for the demanding needs of your energy monitoring and cost management applications. Meters in the series range comply with Class 1.0 accuracy standards and feature high quality, reliability and affordability in a compact and easy to install format.

## Meter features

The DM6000H / DM6200H meter supports many features, a few of the features are listed below:

- LED display screen: Intuitive self-guided navigation using four buttons LED display, with three lines of concurrent values, and load bar that indicates current loading
- Time counters for measuring meter ON Hrs and power interruptions
- Protective cover to ensure terminal screws do not detach from housing and for safety against unintentional finger contacts with terminals
- Cyber security: The meter enables disabling the RS-485 port through front panel keys against unauthorized access. This feature can also be used for toggling between the RTU devices in case of limited availability of nodes in software system
- Measurement of True PF

You can use the meter as a stand-alone device, but its extensive capabilities are fully realized when used as part of an energy management system.

For applications, feature details, and the most current and complete specifications of the DM6000H / DM6200H meter, see the technical datasheet at [www.se.com](http://www.se.com).

## Applications

The meters can be used in various cost management and network management application. Some of the import applications are mentioned below.

### Cost management

- Electrical installation remote monitoring
- Motor control centres
- Control panels
- Power distribution boards
- Original equipment manufacturers (OEMs)
- Building management system
- Panel instrumentation
- Energy management system

### Network management

- Measurement of power factor
- % unbalance for voltage and current



- Phase angle between the respective voltage and current phase
- Modbus RTU protocol, RS-485 communication port for integration with energy management systems (DM6200H only)

## Main characteristics

- **Easy to install:** The device can be mounted on a panel using two retainer clips. This is a compact meter with 49 mm meter depth behind the panel that can connect up to 480 V + 10% AC L-L without voltage transformers for installation compliant with measurement category III, and double insulated.
- **Easy to operate:** The device has intuitive navigation with self-guided menus and heartbeat LED that indicate normal functioning of your device. It also conveys the communication status when connected to an RS-485 network.
- **LED display:** The device has intuitive navigation with self-guided four buttons, 8 segment alpha-numeric LED, and three lines of concurrent values with Kilo and Mega value indicator.
- **Standard compliance:**
  - Accuracy Class 1.0 for V AF PF metering
  - CE certification as per IEC 61010-1 Edition 3
  - cULus as per UL61010-1 and CAN/CSA-C22.2 IEC 61010-1 edition 3, for 480 V AC L-L
  - EMI / EMC tests as per IEC 61326-1
- **CT nominal:** 5 A or 1 A nominal current (field settable).
- **Password:** Field configurable password to secure set up information and prevent tampering of integrated values.
- **Cyber security:** The device provides an option for disabling RS-485 port through front panel keys to prevent unauthorized access. This feature can also be used for maintenance and troubleshooting of complex communication network.
- **Display:** The device has an auto scale and auto range display capability that provides 4 digits for Instantaneous parameters .
- **Analog load bar:** The device's front panel has a colour-coded analogue load bar that indicates the percentage of load through 12 LED with the option to select full scale based on connected load.
- **Suppression current:** The meter can be configured to disregard the measurement of induced / auxiliary load current in the circuit (can be set from 5 to 99 mA).
- **Time counters:** For measuring meter ON hours and power interruptions

## Feature summary

Parameter	DM6000H	DM6200H
Sampling rate per cycle	32	32
Current: <ul style="list-style-type: none"> <li>• Per-phase and 3 phase average</li> <li>• Calculated neutral current</li> </ul>	✓	✓
Voltage: <ul style="list-style-type: none"> <li>• V L-N - per-phase and 3 phase average</li> <li>• V L-L - per-phase and 3 phase average</li> </ul>	✓	✓
Power Factor <ul style="list-style-type: none"> <li>• Per-phase and average</li> </ul>	✓	✓
Frequency	✓	✓
3 Phase unbalance	Current	Current

Parameter	DM6000H	DM6200H
	Voltage	Voltage
Meter On hours	✓	✓
Power Interruptions		
Phase angle <ul style="list-style-type: none"> <li>• Per-phase (between Voltage and Current)</li> </ul>	✓	✓
Communication	—	RS-485 Modbus RTU
Revolutions per minute (RPM)	✓	✓
Load percentage	✓	✓

## Measured parameters

### Instantaneous

The meter provides highly accurate 1-second measurements, average values, including true RMS, per phase and total for:

- Per-phase and average voltage (line-to-line, line-to-neutral)
- Per-phase and average current, and neutral current (calculated)
- Per-phase and average power factor
- System frequency
- Revolutions per minute (RPM)
- Unbalance (Voltage, Current)
- Load percentage
- Phase angle, per-phase (between Voltage and Current)

## Data display and analysis tools

### Power Monitoring Expert

EcoStruxure™ Power Monitoring Expert is a complete supervisory software package for power management applications.

The software collects and organizes data gathered from your facility's electrical network and presents it as meaningful, actionable information via an intuitive web interface.

Power Monitoring Expert communicates with devices on the network to provide:

- Real-time monitoring through a multi-user web portal
- Trend graphing and aggregation
- Power quality analysis and compliance monitoring
- Preconfigured and custom reporting

See the EcoStruxure™ Power Monitoring Expert online help for instructions on how to add your device into its system for data collection and analysis.

### Power SCADA Operation

EcoStruxure™ Power SCADA Operation is a complete real-time monitoring and control solution for large facility and critical infrastructure operations.

It communicates with your device for data acquisition and real-time control. You can use Power SCADA Operation for:

- System supervision
- Real-time and historical trending, event logging
- PC-based custom alarms

See the EcoStruxure™ Power SCADA Operation online help for instructions on how to add your device into its system for data collection and analysis.

## Meter configuration

Meter configuration can be performed through the display (if your meter is equipped with one), the meter webpages or PowerLogic™ ION Setup.

ION Setup is a meter configuration tool that can be downloaded for free at [www.se.com](http://www.se.com).

See the ION Setup online help or in the ION Setup device configuration guide. To download a copy, go to [www.se.com](http://www.se.com) and search for ION Setup device configuration guide.

# Hardware reference

## Meter types

The DM6000H / DM6200H series is available in one physical form factor.

Commercial reference	Description
METSEDM6200HCL10RS	Class 1 panel mount meter with RS-485 and integrated display.
METSEDM6000HCL10NC	Class 1 panel mount meter with integrated display.

## Supplemental information

This document is intended to be used in conjunction with the installation sheet that ships in the box with your device and accessories.

See your device's installation sheet for information related to installation.

See your product's catalog pages at [www.se.com](http://www.se.com) for information about your device, its options and accessories.

You can download updated documentation from [www.se.com](http://www.se.com) or contact your local Schneider Electric representative for the latest information about your product.

## Physical description

### Front

The front panel has three rows of four digits/characters each, with auto scaling Kilo (K), Mega (M), and minus (-) indications. The **K** and **M** indicators are lit together to show Giga readings. The load bar graph to the right of the display gives the indication of consumption in terms of the % ampere load with respect to the full scale (FS) selected. Four smart keys make navigating through parameters very quick and intuitive for viewing data and configuring the meter.

### Rear

The voltage and current terminal and RS-485 communication port are located on the back of the meter.

## Front panel

The front panel contains the following indicators and controls:

- **Eight-segment LED display:** Three rows of alphanumeric displays, four digits each, display three RMS parameters simultaneously. The displayed readings update every second.
- **Analog load bar:** Unique indication of % load with respect to the full scale (FS).
- **Indicators:** Each row displays Kilo, Mega (Kilo + Mega = Giga) indicators, and a negative (-) indicator.
- **Keys:** Four smart keys to scroll through the display pages.

## Analog load bar





- Unique indication of total load % with respect to the full scale through the 12 LED at the right side of the display.
- A bar graph indicating 10% load through each LED.
- The load bar help in finding the total load. To calculate total load, count the number of illuminated LED, and multiply by 10.

### Load percentage and bar graph indication

Load percentage	Bar graph display
Less than 10%	No LED is lit.
Between 10% to 40%	Amber LED get lit.
Between 50% to 80%	Green LED get lit to indicate that the load is acceptable and should not be increased further.
Above 80%	Red LED get lit to indicate that the load has exceeded the sanctioned limit and is dangerous.

## Indicators

### Kilo, Mega, and negative

	<b>Kilo:</b> When lit, indicates that the reading is in Kilo ( $10^3$ ). 10,000 is displayed as 10.00 K and 1000 as 1000.
	<b>Mega:</b> When lit, indicates that the reading is in Mega ( $10^6$ ). 10,000 K is shown as 10.00 M and 1000 K as 1000 K.
	<b>Giga:</b> When Kilo and Mega are lit together, the reading is in Giga ( $10^9$ ). 10,000 M is shown as 10.00 G and 1000 M as 1000 M.
	<b>Negative:</b> When lit, indicates a negative reading.  When Current is reversed: PF (power factor) display negative indication.

## Decimal point scaling

### Giga (M+K), Mega (M), Kilo (K), and decimal point scaling - RMS, Current and Voltage





RMS Reading	Indicator
Less than 0.001	K, M OFF, displays <b>0.000</b>
Less than 9999	K, M OFF
Above 9999	K ON, M OFF
Above 9999 K	M ON, K OFF
Above 9999 M	Giga (K + M indicators ON)
Up to 9999 G	Giga
Above 9999 G	Display shows <b>Hi</b>

RMS readings are four digits. The maximum number the meter handles is 9,999 G for RMS.

## Smart keys

Operating the meter is easy, using the four smart keys to navigate through the display pages. The display pages expand as you go to the right, much like the directory or explorer tree displayed on any computer. The display shows where you are headed.

### Smart keys description

	<p><b>Right key / OK key</b></p> <ul style="list-style-type: none"> <li>• Going <b>forward</b> into sub-parameter pages.</li> <li>• To enter into <b>Setup</b> page. This action requires password.</li> <li>• Selecting the parameter to edit under <b>Setup</b>.</li> </ul>
	<p><b>Left key</b></p> <ul style="list-style-type: none"> <li>• Going <b>back</b> to the main parameter pages.</li> <li>• Selecting <b>previous digit</b> on the left, under setup.</li> <li>• Exiting from editing <b>Setup</b> page.</li> </ul>
	<p><b>Up key</b></p> <ul style="list-style-type: none"> <li>• <b>Scrolling up</b> through display pages at the same level, <b>within the same function</b>.</li> <li>• <b>Increasing</b> the value of the selected digit or navigating to the next available selection.</li> </ul>
	<p><b>Down key</b></p> <ul style="list-style-type: none"> <li>• <b>Scrolling down</b> through other display pages at the same level, through all functions.</li> <li>• <b>Decreasing</b> the value of the selected digit or navigating to the next available selection.</li> </ul>

### Keypad operation

Press a key in the direction you want to go. The display shows the next parameter as per navigation. Press OK to enter a parameter setup.

The following steps explain how to navigate from the **RMS** page to the **VLN A F** page and back to **RMS** page.

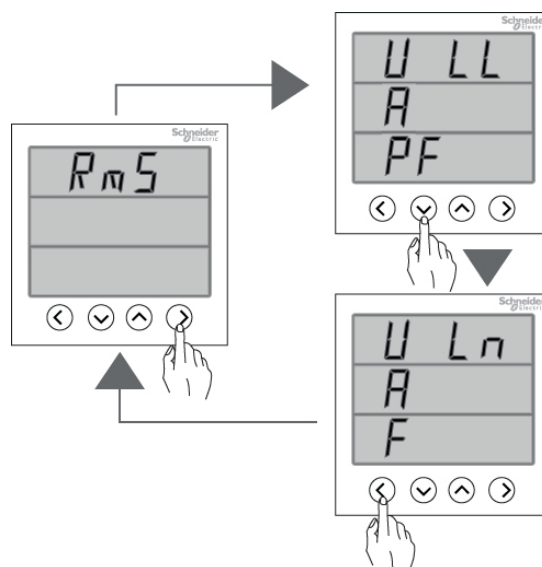

1. From the **RMS** page, press right button. The display shows **VLL A PF**.
2. Press down button. The display shows **VLN A F**.
3. To return to **RMS**, press left button. The display shows **RMS**.

**NOTE:** Use right button to go forward to the sub-parameter page and use left button to go backward to the main parameter pages. Use up button and down button to scroll up and down through the display pages.

### Auto scroll

Auto-scroll allows you to monitor a group of display pages sequentially, every eight seconds, without manual key operation. This is convenient for viewing from a distance. The meter shows the parameter name for two seconds followed by the value for eight seconds.

## Panel meter

### LED indicators

The LED indicators alert or inform you of meter activity or status. Refer to the image below for the various LED indicators the meter provides.



A	Heartbeat / serial communications LED (Green)
---	-----------------------------------------------

### Rear wiring

The meter provides current and voltage inputs along with other wiring options. Refer to the image below for various wiring options the meter provides.

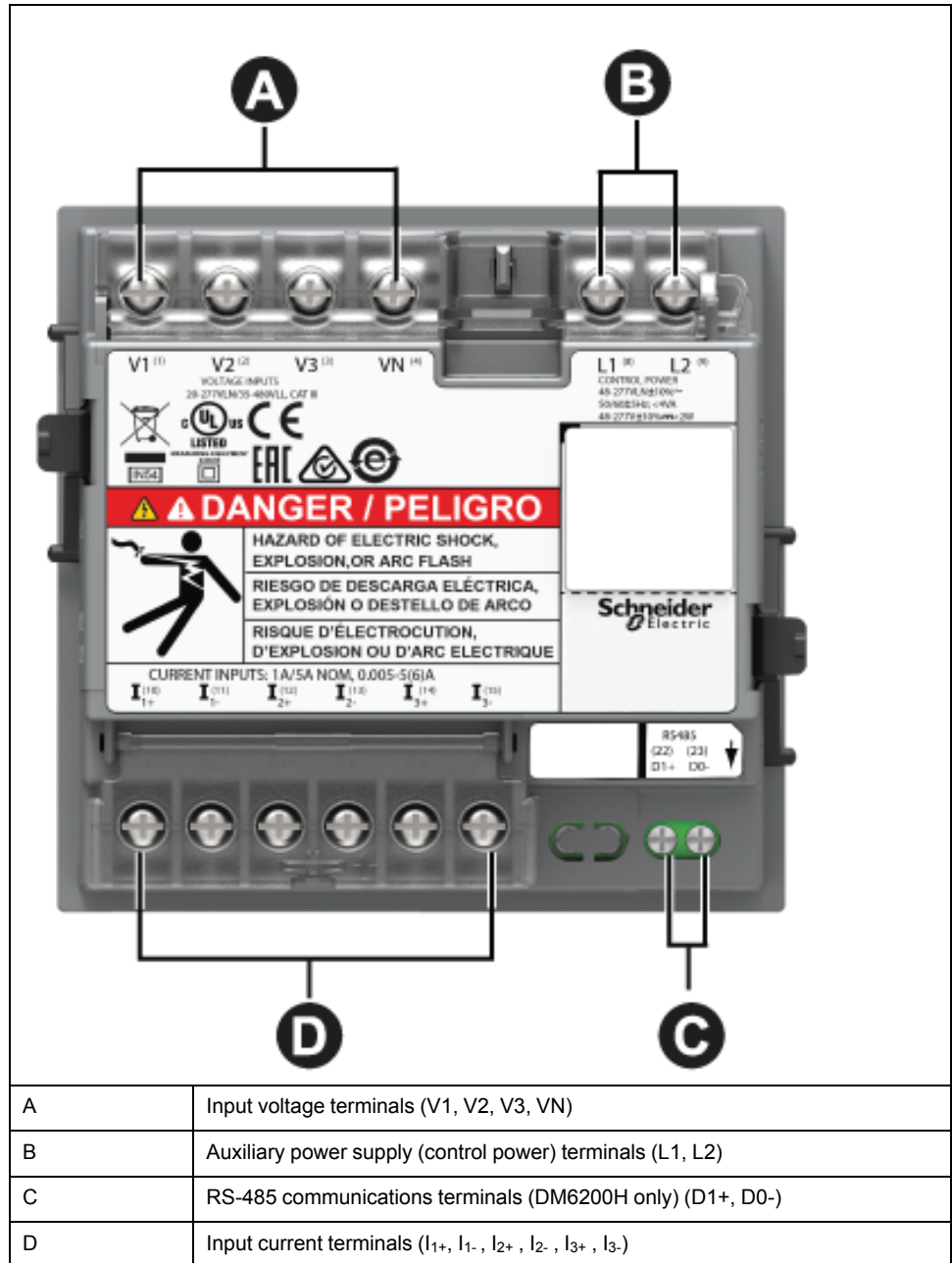

## Protective cover

The voltage and current terminal covers help prevent tampering with the meter's voltage and current measurement inputs.

The terminal covers enclose the terminals, the conductor fixing screws and a length of the external conductors and their insulation. Ensure you use a device (screwdriver recommended) to push the cover upwards till you hear a click to make the cover stand. These covers are included for meter models where sealable voltage and current covers are required to protect against tampering of current and voltage input signals. Refer to your meter's installation sheet or the instructions that came with your terminal covers for instructions on installing the terminal covers.

## Meter mounting

For mounting instructions and safety precautions, see the installation sheet that was shipped with your device, or download a copy at [www.se.com](http://www.se.com).



## Meter wiring

For wiring instructions and safety precautions, see the meter installation sheet that was shipped with your meter, or download a copy at [www.se.com](http://www.se.com).

## Direct connect voltage limits Measuring voltage limit

You can connect the meter's voltage inputs directly to the phase voltage lines of the power system if the power system's line-to-line or line-to-neutral voltages do not exceed the meter's direct connect maximum voltage limits.

The meter's voltage measurement inputs are rated by the manufacturer for up to 277 V L-N / 480 V L-L. However, the maximum voltage allowed for direct connection may be lower, depending on the local electrical codes and regulations. As per installation category III the maximum voltage on the meter voltage measurement inputs should not exceed 277 V L-N / 480 V L-L.

If your system voltage is greater than the specified direct connect maximum voltage, you must use VTs (voltage transformers) to step down the voltages.

## Balanced system considerations

In situations where you are monitoring a balanced 3-phase load, you may choose to connect only one or two CTs on the phase(s) you want to measure, and then configure the meter so it calculates the current on the unconnected current input(s).

**NOTE:** For a balanced 4-wire Wye system, the meter's calculations assume that there is no current flowing through the neutral conductor.

### Balanced 3-phase Wye system with 2 CTs

The current for the unconnected current input is calculated so that the vector sum for all three phases equal zero.

### Balanced 3-phase Wye or Delta system with 1CT

The currents for the unconnected current inputs are calculated so that their magnitude and phase angle are identical and equally distributed, and the vector sum for all three phase currents equal zero.

**NOTE:** You must always use 3 CTs for 3-phase 4-wire center-tapped Delta or center-tapped open Delta systems.

## Serial communications

The meter supports serial communication through the RS-485 port.

In an RS-485 network, there is one master device, typically an Ethernet to RS-485 gateway. It provides the means for RS-485 communications with multiple slave devices (for example, meters). For applications that require only one dedicated computer to communicate with the slave devices, an RS-232 to RS-485 converter can be used as the master device. In master device, recommended response time-out setting should be minimum 1 second.

### RS-485 configuration

Before connecting your device to the RS-485 bus, use the meter's display, or ION Setup to configure your meter's default RS-485 settings.

Your meter has one RS-485 connection.

Your meter must have a unique unit identifier (address) and have the following settings match the rest of the devices on the RS-485 bus:

- Protocol
- Baud rate
- Parity

You can use a communications converter (USB to RS-485 or RS-232 to RS-485) to connect to your meter.

## Serial protocols

Your meter supports the serial communication protocol on its RS-485 port.

- Modbus RTU

## RS-485 wiring

Connect the devices on the RS-485 bus in a point-to-point configuration, with the (+) and (-) terminals from one device connected to the corresponding (+) and (-) terminals on the next device.

### RS-485 cable

Use a shielded 2 wire or 1 twisted pair RS-485 cable to wire the devices. Use either shielded 2 wire or 1 twisted pair to connect the (+) and (-) terminals.

The total distance for devices connected on an RS-485 bus should not exceed 900 m (2953 ft).

**NOTE:** You can connect a maximum of 32 devices to a single RS-485 bus.

### RS-485 terminals

-	Data minus. This transmits/receives the inverting data signals.
+	Data plus. This transmits/receives the non-inverting data signals.

## RS-485 network configuration

After you have wired the RS-485 port and powered up the meter, you must configure the serial communications port in order to communicate with the meter.

Each device on the same RS-485 communications bus must have a unique address and all connected devices must be set to the same protocol, baud rate, and parity (data format).

**NOTE:** To communicate with the meter using ION Setup, you must set the serial site and all connected devices in the RS-485 network to the same parity setting.

For meters that do not have a display, you must first wire and configure each one separately before connecting these meters to the same RS-485 bus.

# Display and meter setup

## Display overview

The display lets you use the meter to perform various tasks such as setting up the meter, displaying data screens, or performing resets.



A	Analog load bar
B	Retainer clip
C	Alpha numeric LED display
D	LED indicators
E	Menu selection buttons

## Heartbeat / serial communications LED

The heartbeat / serial communications LED blinks to indicate the meter's operation and serial Modbus communications status.

The LED blinks at a slow, steady rate to indicate the meter is operational. The LED flashes at a variable, faster rate when the meter is communicating over a Modbus serial communications port.

You cannot configure this LED for other purposes.

**NOTE:** A heartbeat LED that remains lit and does not blink (or flash) can indicate a problem. In this case, power down the meter and reapply power. If the LED still does not blink or flash, contact Technical Support.

## Meter screen menus

All meter screens are grouped logically, according to their function. You can access any available meter screen by first selecting the Level 1 (top level) screen that contains it.

With the meter front panel, you can view parameter values; configure parameters; perform demand resets; perform LED checks; and view meter information. Each of these functions can be accomplished by pressing the Up, Down, and OK buttons on the front panel.

These button actions achieve different results according to the mode that the meter is in:

- Display mode (default): view parameter measurements
- Setup mode: configure a parameter
- Diagnostics mode: verify that the front panel display LEDs are operational, and view meter information (e.g. meter model, firmware version, etc.)
- Lock mode: lock or unlock a screen

This section describes front panel navigation within each mode.

## Viewing parameters

The meter's display screen and buttons allow you to view the required parameters.

### To view display parameters:

1. Press the **Up** or **Down** button to navigate to **RMS** menu.
2. Press **OK**.
3. Press the **Up** or **Down** button to navigate to the previous or next parameter page.

## Display screen menu tree



Use the menu tree to navigate to the setting you want to view.

### RMS Parameter navigation

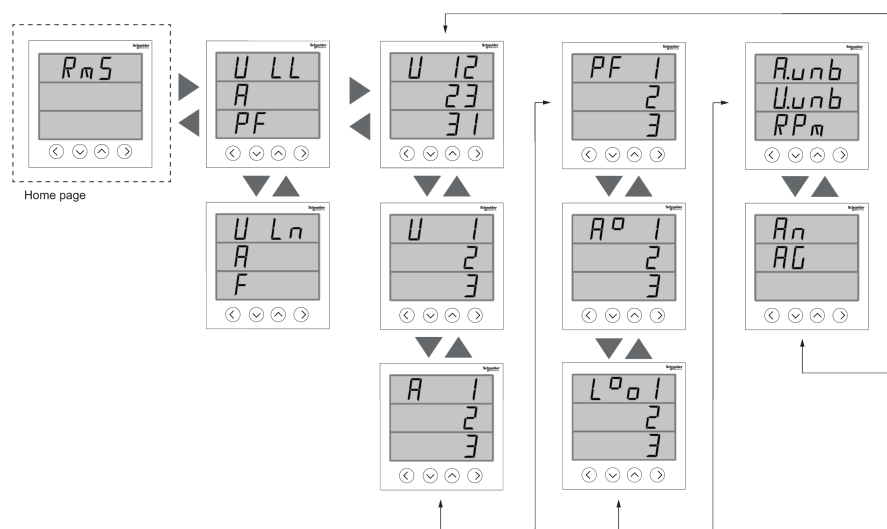
The below image summarizes the **RMS** parameters:



## Button functions in viewing parameters

Mode	Button	Description	Function
Display mode <b>NOTE:</b> Display mode is view-only and displays the parameter values.		<b>Down key:</b> To navigate down	To view the next parameter value.
		<b>Up key:</b> To navigate up	To view the previous parameter value.
		<b>Right / OK key:</b> To navigate right / Enter key	To move from one page to the next.

## Setup screen menus

Setup screen enables you to configure various setup parameters.

The meter's display screen and buttons allow you to navigate to and edit the required parameters.

### To enter into setup:

1. From the **Home** page, use **Up** or **Down** button to navigate to **Maintain**.
2. Press **OK**.
3. Use **Up** or **Down** button to navigate to **Set**.
4. Press **OK**.
5. Enter the password. Default password is 0000.
6. Press **OK** to enter **Setup**.
7. Press **Left** button to exit **Setup** after viewing parameters.

Below is the list of setup parameters and the configurations it supports.

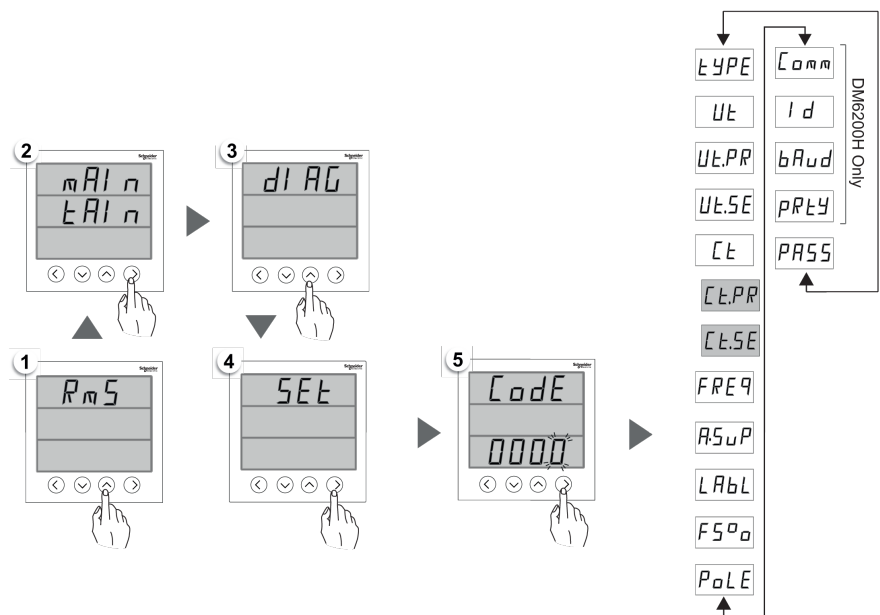

### DM6000H / DM6200H meter setup menus:







## Setup parameters

Name on display	Description	Input range	Default value
<b>TYPE</b>	<b>TYPE:</b> Power System Configurations	[1P.Ln, 1P.LL, 1P.3L, 3P.3L, 3P.4L] <b>NOTE:</b> Other power system configurations can be set through ION setup.	3P.4L
<b>VT</b>	<b>VT:</b> Voltage Transformer	[no.Vt, 2.VT, 3.VT, 1.VT] <b>NOTE:</b> The VT Connect parameters are enabled based on selected power system configuration.	no.Vt
<b>VT.PR</b>	<b>Vt.Pr:</b> Primary Voltage (V L-L)	[0100 V to 999000 V] <b>NOTE:</b> VT.PR will not be enabled if VT Connect is no.VT.	415
<b>VT.SE</b>	<b>Vt.SE:</b> Secondary Voltage (V L-L)	[100, 110, 115, 120, 415] <b>NOTE:</b> VT.SE will not be enabled if VT Connect is no.VT.	415
<b>CT</b>	<b>Ct:</b> Current Transformer	[A.1, A.2, A.3, A.12, A.23, A.31, A.123] <b>NOTE:</b> The CT terminal parameters are enabled based on the selected power system and VT connect configuration.	A.123
<b>CT.PR</b>	<b>Ct.Pr:</b> CT Primary	[1 A to 32760 A] <b>NOTE:</b> CT primary can be set to 32767 A through communication.	100
<b>CT.SE</b>	<b>Ct.SE:</b> CT Secondary	[1 A, 5 A]	5
<b>FREQ</b>	<b>FrEq:</b> System Frequency	[50 Hz, 60 Hz]	50
<b>A.SUP</b>	<b>A.SUP:</b> A.Suppression (Minimum current at which meter starts functioning)	[5 to 99 mA]	005
<b>LABL</b>	<b>LABL:</b> Phase labeling	[123, Abc, rst, pqr, ryb]	123
<b>FS%</b>	<b>FS%:</b> Full scale value (Rescaling analog load bar with respect to CT loading)	[1 to 100]	100
<b>POLE</b>	<b>POLE:</b> To determine RPM of alternator / generator based on number of poles and network frequency	[2, 4, 6, 8, 10, 12, 14, 16]	4
<b>COMM</b>	<b>COMM:</b> Communication <ul style="list-style-type: none"> <li>ON / OFF: To enable / disable communications port.</li> <li>Retrofit (RTFT): For configuring legacy communication data models.</li> </ul>	[ON, RTFT, OFF]	ON
<b>ID</b>	<b>ID:</b> Unit ID	[1-247]	1
<b>BAUD</b>	<b>BAUD:</b> BPS (Baud rate per second)	[4800, 9600, 19200, 38400]	19200
<b>PRTY</b>	<b>PRTY:</b> Parity	[Even, Odd, None]	Even
<b>PASS</b>	<b>PASS:</b> Password	Can be configured from 0000 to 9999 <b>NOTE:</b> Record your password in a secure location.	0000

### Button functions in viewing setup parameters

Mode	Button	Description	Function
Setup menu		<b>Down key:</b> To navigate down	To navigate to the next parameter configuration screen.
		<b>Up key:</b> To navigate up	To navigate to the previous parameter configuration screen.
		<b>Right / OK key:</b> To navigate right / Enter key	Enter setup mode to configure the displayed parameter value.

### Button functions in editing setup parameters

Mode	Button	Function
Setup menu		<i>Flashing digit:</i> To decrease the numeric value. <i>Flashing value:</i> To view the previous value from the list. <i>Flashing decimal point:</i> To move decimal point to left.
		<i>Flashing digit:</i> To increase the numeric value. <i>Flashing value:</i> To view the next value from the list. <i>Flashing decimal point:</i> To move decimal point to right.
		<b>Long press:</b> Press and hold for 2 seconds. <i>Flashing digit:</i> To move the position of the cursor to left.
		To select a parameter to edit the values. To save the changes made to setup parameter.

### Editing setup parameters

The following steps describe how to edit parameters in setup mode.

1. From the **Home** page, use **Up** or **Down** button to navigate to **Maintain**.
2. Press **OK**.
3. Use **Up** or **Down** button to navigate to **Set**.
4. Press **OK**.
5. Enter password. Default password is 0000.
6. Press **OK**.
7. Press the **Up** or **Down** button to select a parameter to edit. The selected parameter flashes the digit, value, or decimal point that is required to be set (the meter automatically determines which option to flash for editing, depending on the parameter).
8. Increase or decrease the digit value, move the decimal point, or select a value from a pre-programmed list using the **Up** or **Down** button.
9. Press **OK** after making the required changes.
10. Press **Left** button.
11. Select **Yes** to save your settings.

**NOTE:** Select **No** to exit setup mode without saving any settings.

## Communications setup

After wiring the meter's serial communications ports, you can configure these ports so you can connect to the meter remotely and use device configuration software such as ION Setup to configure the meter.

The setup screen allows you to configure the meter's RS-485 communications port so you can use software to access the meter's data or configure the meter remotely.

To turn on communication in setup screen, follow these steps:

1. From the **Home** page, use **Up** or **Down** button to navigate to **Maintain**.
2. Press **OK**.
3. Use **Up** or **Down** button to navigate to **Set**.
4. Press **OK**.
5. Enter password. Default password is 0000.
6. Press **OK**.
7. Use **UP** or **Down** button to select **Comm** (communication).
8. Press **OK**.
9. Press the **Down** button to select **ON** from the list.
10. Press **OK**.
11. Press **Left** button.
12. Select **Yes** (press **OK** button) to save your settings.

### RS-485 communication parameters

Parameter	Values	Description
Unit ID	1 to 247	Set the address for this device. The address must be unique for each device in a communications loop.
Baud Rate	4800, 9600, 19200, 38400	Select the speed for data transmission. The baud rate must be the same for all devices in a communications loop.
Parity	Even Odd None	Select None if the parity bit is not used. The parity setting must be the same for all devices in a communications loop. Parity is measured in number of stop bits.

**NOTE:** Communication parameters display ON / OFF / Retrofit (RTFT). Retrofit provides you an option of configuring legacy data models for your device to communicate with newer models.

## Password setup

The meter password can only be configured through the front panel. The factory-default setting for all passwords is "0000" (zero). Changing the default password for screens that are password protected prevents unauthorized personnel from accessing certain screens such as the Setup and Clear screens.



To change the meter password using Setup, follow these steps:

1. From the **Home** page, use **Up** or **Down** button to navigate to **Maintain**.
2. Press **OK**.
3. Use **Up** or **Down** button to navigate to **Set**.
4. Press **OK**.
5. Enter password. Default password is 0000.
6. Press **OK**.
7. Press the **Up** button to select **PASS** (password) parameter.
8. Press **OK**.
9. Press the **Down** or **Up** button to change the digits.

**NOTE:** Use the Left button to move the cursor to the next digit.

10. Press **OK**.
11. Press **Left** button.
12. Select **Yes** (press **OK** button) to save your settings.

**Password settings**

Parameter	Values	Description
Pass	0000 - 9999	Sets the password for accessing the meter setup screen.  <b>NOTE:</b> Common password applies across all parameters.

**Lost password**

Visit [www.se.com](http://www.se.com) for support and assistance with lost passwords or other technical problems with the meter. Make sure you include your meter’s model, serial number, and firmware version in your email or have it readily available if calling Technical Support.

**Diagnostics (Diag) screen menus**

In Diag, you can verify the front panel LEDs, and view meter information.

The meter’s display screen and buttons allow you to navigate to the Diag.

To view Diag screens, follow these steps:

1. From the **Home** page, use **Up** or **Down** button to navigate to **Maintain**.
2. Press **OK**.
3. Use **Up** or **Down** button to navigate to **Diag**.
4. Press **OK**.
5. Press the **Down** button to navigate to the next **Diag** screen.
6. Press **Left** button to exit.

**DM6000H / DM6200H meter Diag menus**

Below is the list of Diag parameters that are displayed on the meter screen.

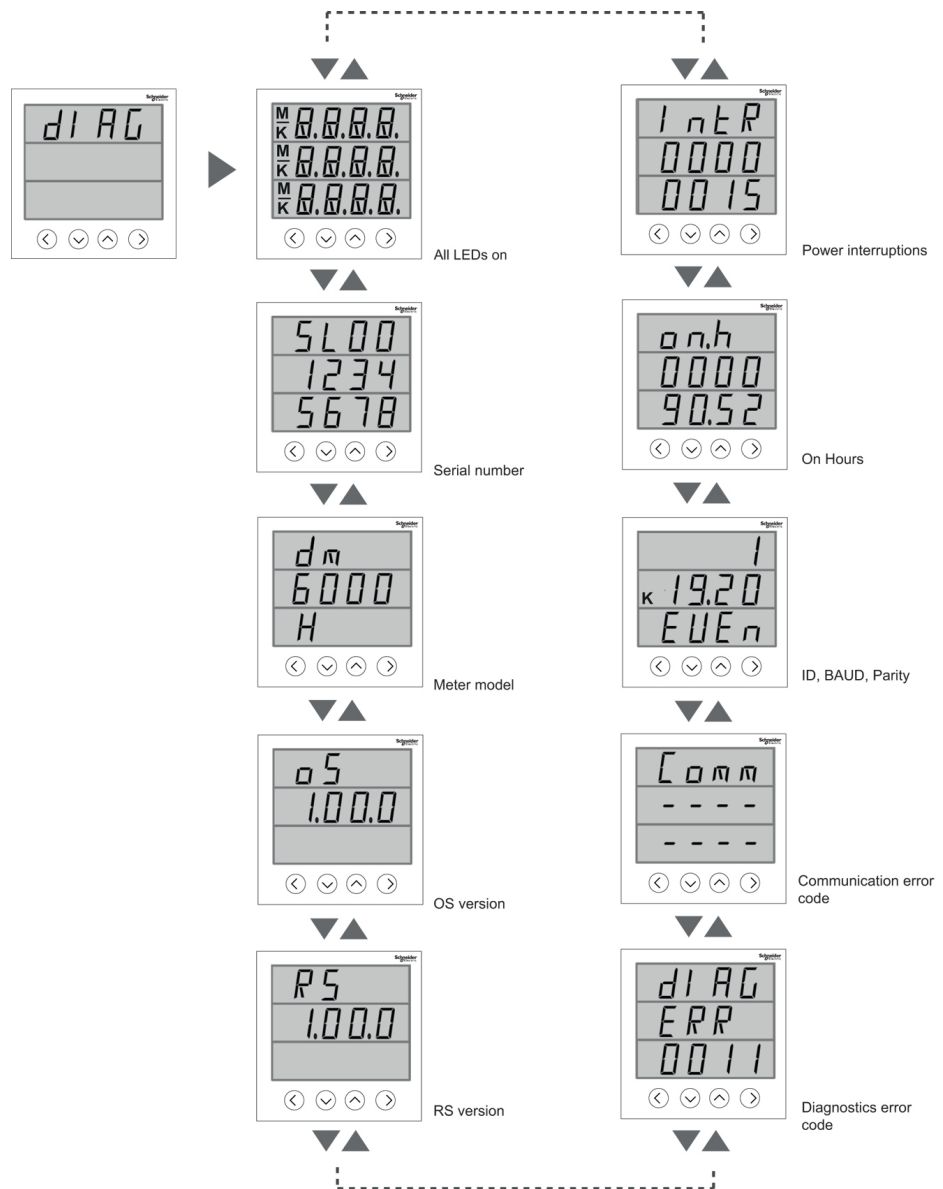



**Diag parameters**

Screens	Description
All LED on	On entering Diag screen, all LED on the front panel light up. This indicates that the front panel LED and display are operating correctly. <ul style="list-style-type: none"> <li>The display for each line shows four eights (8888), four decimal points (...), negative indicators(-), M and K indicators lit up.</li> <li>All Load bar LED and Energy LED lit up.</li> </ul>
Serial number	Displays the meter serial number, for example SL1200005174. <b>NOTE:</b> Ensure you have your meter's serial number information available while contacting Technical Support for help.
Meter Model	Displays the meter model number.
OS version	Displays the operating system version number, for example OS 1.00.0.
RS version	Displays the reset (boot code) version number, for example RS 1.00.0.
Diagnostics error code	Displays the error codes of the meter for diagnostics. For example: 0041 is the error code for Over-Running energy pulse output.
Communication error code	Displays the communication errors of the meter (DM6200H only).

### Diag parameters (Continued)

Screens	Description
ID, BAUD, Parity	Displays the unit ID, baud rate, and parity values of the meter (DM6200H only).
Meter On hours	Displays the meter on (auxiliary / control power ON) duration.
Power interruptions	Displays the power interruptions counter.

### Button functions in viewing Diag screen

Mode	Button	Function
Diag menu		To navigate to the next screen.
		To navigate to the previous screen.
		Press the Left button to exit Diag screen.

### Lock / unlock

Lock enables you to set the meter screen to default screen. You can scroll to other display screens while a screen is locked. Once the manual scrolling is stopped, the meter displays the default (lock) screen after 4 minutes.

### Locking / unlocking meter screen



The meter’s display screen and buttons allow you to lock or unlock any screen.

Press and hold the **Up** and **Down** buttons simultaneously for 2 seconds to lock or unlock a meter screen.

**NOTE:**

You can only lock the display parameters. You cannot enter the **Setup** or **Reset** when a meter screen is locked.

### Button functions in locking / unlocking meter screen

Mode	Button	Function
Lock / Unlock	 + 	Press and hold the <b>Up</b> and <b>Down</b> buttons simultaneously for 2 seconds to lock or unlock a meter screen.

# Security

## Security overview

Your Schneider Electric product is equipped with security-enabling features.

These features arrive in a default state and can be configured for your installation needs. Please note that disabling or modifying settings within the scope of these individual features can impact the overall security robustness of the device and ultimately the security posture of your network in either positive or negative ways. Review the security intent and recommendations for the optimal use of your device's security features.

Products are hardened to increase security robustness. This is an ongoing process consisting of secure development practices, inclusion of security features and testing at our security test facilities. Following system hardening best practices is also necessary to help ensure your overall system security.

See the [Cybersecurity Hardening Best Practices](#) white paper for suggested best practices.

## Security features on your device

Your device comes with security features that you can configure to help protect against unauthorized configuration and access to your device's data through its user interfaces or communications.

### Passwords and user accounts

The meter has configurable password for the display.

Leaving the password at the default value makes it easier for a potential attacker to gain unauthorized access to your device. It is recommended that you change your password from the default value.

### Password best practices

Recommended password best practices help to improve security on your meter.

- Change your meter's password from the default value.
- Make your meter's passwords as complex as possible.

**NOTE:** Make sure that the user password you enter is compatible with the software used to communicate with your device.

- Schedule regular changes to your meter's passwords.
- Record your meter's passwords in a secure location.

If your meter's user access information is lost, you must return the meter to the factory, where your meter is reset to its factory defaults and all logged data is lost.

### **NOTICE**

#### **DATA LOSS**

Record your device's user and password information in a secure location.

**Failure to follow these instructions can result in equipment damage.**

# Remote meter setup

## Overview

You can configure the meter's setup parameters through the meter's RS-485 communications port.

The meter is factory-configured with default RS-485 communications port settings. You must modify the default settings before connecting the meter to your RS-485 network. To configure the RS-485 port, you need:

- ION Setup

## ION setup

Go to [www.se.com](http://www.se.com) and search for ION Setup to download a copy of the installation file.

If you already have an existing installation of ION Setup, it is recommended that you upgrade to the latest version in order to access new features or enhancements and properly configure features available on your device.

Refer to the online help to learn how to use ION Setup.

## RS-485 port setup

The meter is factory-configured with default serial communications settings that you may need to modify before connecting the meter to the RS-485 bus.

The meter is factory-configured with the following default serial communications settings:

- Protocol = Modbus RTU
- Address = 1
- Baud rate = 19200
- Parity = Even

You can use a communications converter (USB to RS-485 or RS-232 to RS-485) device to connect to the meter.

## Meter setup through RS-485

After the meter's RS-485 port is configured and connected to the RS-485 network, you can use ION Setup to configure all other meter setup parameters.

## Using a serial communications converter to set up RS-485

You can use a communications converter (USB to RS-485 or RS-232 to RS-485) to connect to the meter.

**NOTE:** Configuring the serial communications settings using this method may cause ION Setup to lose communications when the changes are sent to your meter. You must reconfigure ION Setup to match the new settings to re-establish communications with your meter.

1. Configure the serial communications converter's settings to be compatible with the meter's default communications settings.
2. Connect the meter's RS-485 port to the serial communications converter.
3. Connect the communications converter to the computer.

4. Start ION Setup in Network mode.
5. Add a serial site and set its properties:
  - Comm link = Serial
  - Comm port = select which serial (or USB) port the communications converter is attached to
  - Baud rate = 19200
  - Format = select a format with even parity
6. Add a meter to the site and set its properties:
  - Type = Device name
  - Unit ID = 1
7. Use the setup screens to modify the meter's setup parameters.
8. Use the **RS-485 Base Comm** setup screen to modify the meter's serial communication settings.
9. Click **Send** to save your changes to the meter. You need to reconfigure ION Setup to match the changed settings in order to re-establish communications with your meter.
10. Exit ION Setup.

#### RS-485 port settings

Parameter	Values	Description
Protocol	Modbus RTU	Select the communications format used to transmit data. The protocol must be the same for all devices in a communications loop.  ION Setup does not support ASCII 8, ASCII 7 or JBus protocols.
Address	1 to 247	Set the address for this device. The address must be unique for each device in a communications loop.
Baud rate	4800, 9600, 19200, 38400	Select the speed for data transmission. The baud rate must be the same for all devices in a communications loop.
Parity	Even, Odd, None	Select <b>None</b> if the parity bit is not used. The parity setting must be the same for all devices in a communications loop.

## Meter configuration using ION Setup

Start ION Setup, create a site (or if applicable, use an existing site), then add your meter to the site.

Refer to the ION Setup device configuration guide for information about your meter. To download a copy, go to [www.se.com](http://www.se.com) and search for ION Setup device configuration guide.

# Viewing meter data

## Overview

The section provides you information on viewing various parameter pages in the meter.

## RMS page

### To view RMS parameters:

1. From the **Home (RMS)** page, use **Up** or **Down** button to navigate to **RMS**.
2. Press **OK**.
3. Press the **Up** or **Down** button to navigate to the next RMS parameter.
4. Press **Left** button to exit.

### Parameter navigation

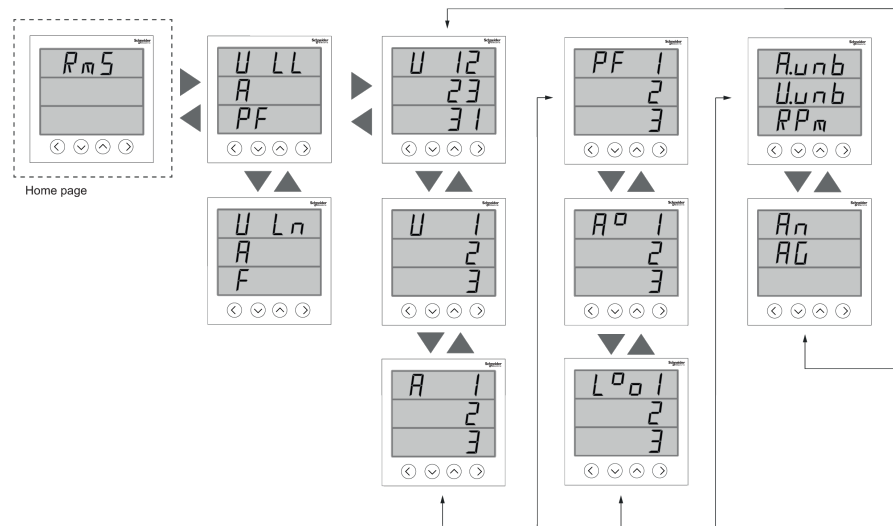

## Diag page

### To view Diag parameter:

1. From the **Home** page, use **Up** or **Down** button to navigate to **Diag**.
2. Press **OK**.
3. Press the **Up** or **Down** button to navigate to the next **Diag** parameter.
4. Press **Left** button to exit.

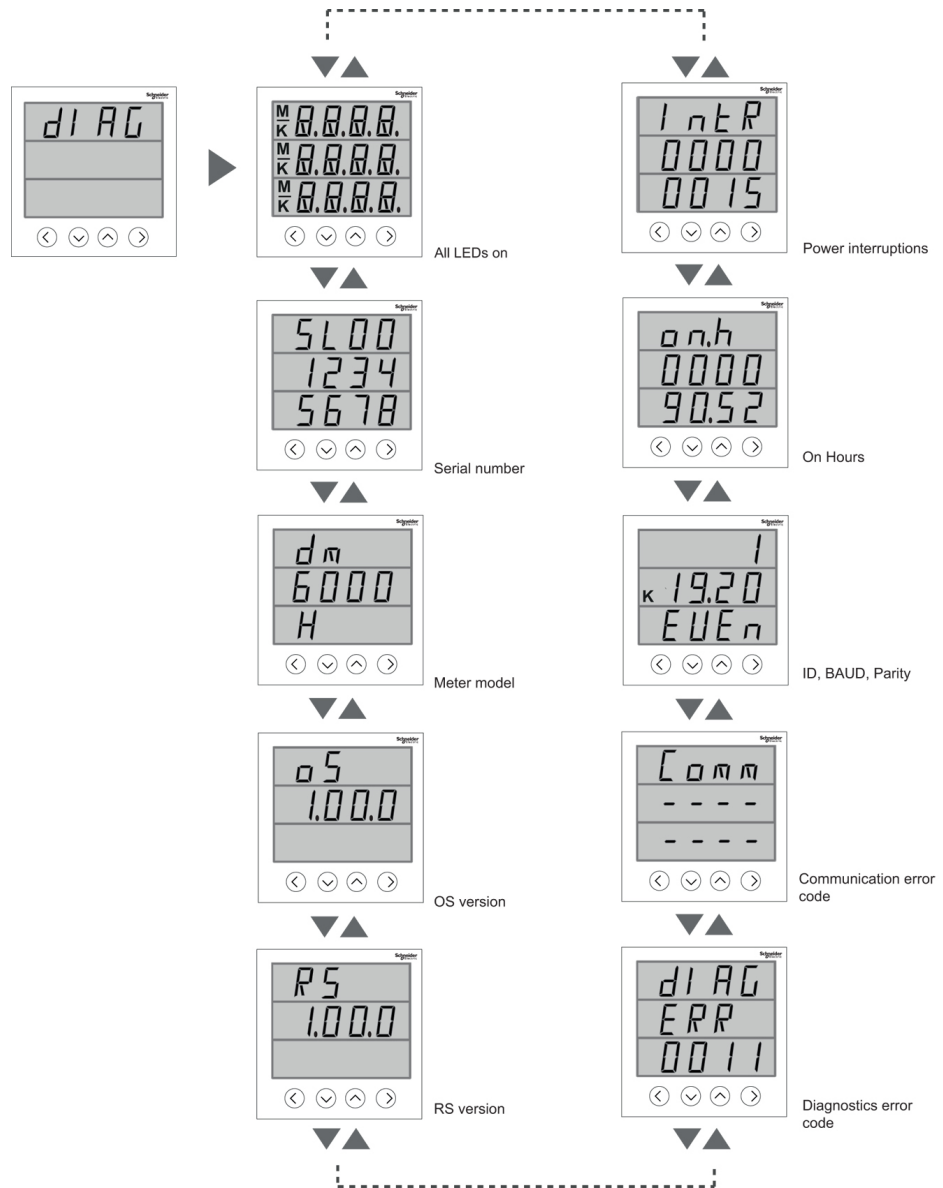

## Using ION Setup to view or modify configuration data

You can use ION setup to view or modify the meter setup parameters.

## Using software to view meter data

There are different software systems and methods you can use to access or display the meter data. This can range from using a simple Modbus register interface to read stored values in the meter’s registers, to viewing intelligent information from the meter through an energy management system.

## Power Monitoring Expert

EcoStruxure™ Power Monitoring Expert is a complete supervisory software package for power management applications.

The software collects and organizes data gathered from your facility’s electrical network and presents it as meaningful, actionable information via an intuitive web interface.



Power Monitoring Expert communicates with devices on the network to provide:

- Real-time monitoring through a multi-user web portal
- Trend graphing and aggregation
- Power quality analysis and compliance monitoring
- Preconfigured and custom reporting

See the EcoStruxure™ Power Monitoring Expert online help for instructions on how to add your device into its system for data collection and analysis.

## Power SCADA Operation

EcoStruxure™ Power SCADA Operation is a complete real-time monitoring and control solution for large facility and critical infrastructure operations.

It communicates with your device for data acquisition and real-time control. You can use Power SCADA Operation for:

- System supervision
- Real-time and historical trending, event logging
- PC-based custom alarms

See the EcoStruxure™ Power SCADA Operation online help for instructions on how to add your device into its system for data collection and analysis.

## Modbus command interface

Most of the meter's real-time and logged data, as well as basic configuration and setup of meter features, can be accessed and programmed using a Modbus command interface as published in the meter's Modbus register list.

This is an advanced procedure that should only be performed by users with advanced knowledge of Modbus, their meter, and the power system being monitored. For further information on the Modbus command interface, contact Technical Support.

See your meter's Modbus register list at [www.se.com](http://www.se.com) for the Modbus mapping information and basic instructions on command interface.

# Measurements and calculations

## Meter initialization

Meter Initialization is a special command that clears the meter's energy, power, demand values, and meter operation timer.

It is common practice to initialize the meter after its configuration is completed, before adding it to an energy management system.

After configuring all the meter setup parameters, navigate through the different meter display screens and make sure the displayed data is valid then perform meter initialization.

**NOTE:** You can perform meter initialization using ION setup and secured command interface.

## Real-time readings

The meter measures currents and voltages, and reports in real time the RMS (Root Mean Squared) values for all three phases and neutral.

The voltage and current inputs are continuously monitored at a sampling rate of 64 samples per cycle. This amount of resolution helps enable the meter to provide reliable measurements and calculated electrical values for various commercial, buildings and industrial applications.

## Timer

The meter support meter on hours.

The timer data can be read through register map.

## Meter on hours

Meter on hours show how long the meter has been powered up.

## Power Interruptions

Displays the power interruptions counter.

# Maintenance and upgrades

## Maintenance overview

The meter does not contain any user-serviceable parts. If the meter requires service, contact your local Schneider Electric Technical Support representative.

<b>NOTICE</b>
<p><b>METER DAMAGE</b></p> <ul style="list-style-type: none"> <li>• Do not open the meter case.</li> <li>• Do not attempt to repair any components of the meter.</li> </ul> <p><b>Failure to follow these instructions can result in equipment damage.</b></p>

Do not open the meter. Opening the meter voids the warranty.

## Troubleshooting LED indicators

Abnormal heartbeat / serial communications LED behavior could mean potential problems with the meter.

Problem	Probable causes	Possible solutions
LED flash rate does not change when data is sent from the host computer.	Communications wiring	If using a serial-to-RS-485 converter, trace and check that all wiring from the computer to the meter is properly terminated.
	Internal hardware problem	Perform a hard reset: turn off control power to the meter, then re-apply power. If the problem persists, contact Technical Support.
Heartbeat / serial communications LED remains lit and does not flash ON and OFF	Internal hardware problem	Perform a hard reset: turn off control power to the meter, then re-apply power. If the problem persists, contact Technical Support.
Heartbeat / serial communications LED flashes, but the display is blank.	Display setup parameters incorrectly set	Review display parameter setup.

If the problem is not fixed after troubleshooting, contact Technical Support for help and ensure you have your meter’s firmware version, model and serial number information available.

## Meter memory

The meter stores configuration and logging information in non-volatile memory and a long-life memory chip.

The meter uses its non-volatile memory (NVRAM) to retain all data and metering configuration values.

## Firmware version, model, and serial number

You can view the meter’s firmware version, model and serial number from the display panel.

1. From the **Home** page, use **Up** or **Down** button to navigate to **Maintain**.
2. Press **OK**.
3. Use **Up** or **Down** button to navigate to **Diag**.
4. Press **OK**.
5. Meter display shows all LED turned on.
6. Press **Down** button to view meter model, serial number, OS version, and RS version.
7. Press **Left** button to exit **Diag** page.

## Firmware upgrades

There are a number of reasons why you may want to upgrade your meter's firmware.

Some of the reasons are mentioned below. It is suggested to keep your meter firmware upgraded for optimum performance.

- Improve meter performance (e.g., optimize processing speed)
- Enhance existing meter features and functions
- Add new functionality to the meter
- Achieve compliance to new industry standards

## Firmware upgrade using DLF3000

The meter contains firmware that can be upgraded using DLF3000.

1. Download the latest version of DLF3000 from [www.se.com](http://www.se.com), then install it on your computer.

**NOTE:** DLF3000 is a free Schneider Electric utility for downloading firmware to your meter.

2. Download your meter's firmware from [www.se.com](http://www.se.com).
3. Start DLF3000.
4. Click **Add**. Navigate to the folder where you saved your meter's firmware.
5. Select the firmware file and click **Open**.
6. Select the firmware, then click **Next**.
7. If you haven't defined an upgrade system yet:
  - Click **New**, then type in the box to assign a system name.
  - Click **Add**, then type in the box to assign a communications connection name.
  - Select the communications driver as Serial Driver.
8. Click **Continue**.
9. Click **Add Device**.
  - Type in the box to assign a device name.
  - Select the device type from the list.
  - Select the connection name, i.e., the one you defined in the previous step.
10. Click **Next**.

11. Make sure the connection name, i.e., the one you defined in the previous step, is still selected. Enter the device address.
12. Select the protocol (e.g., Modbus).
13. Click **OK**.
14. Click **Next**.
15. Select the device name from the **Download Candidate Devices** pane, then click the right arrow button to move the selection to the **Download Target Devices** pane.
16. Select the meter firmware in the **Firmware to** field.
17. Click **Next**.
18. Click **Health Check** to confirm the meter is communicating. The Health Status shows **Passed** to indicate successful communications.
19. Click **Next**.
20. The Firmware Update Group shows the connection name, the firmware version and status (should be “Queued”). The Group Device List shows the device or devices being upgraded. Click **Download**.

**NOTE:** A warning message displays, “Warning: Relays on PowerLogic™ Metering Devices will be de-energized if selected for download and will remain in this mode until a successful download is completed. Press **OK** to start the download.”
21. Click **OK**.
  - The Firmware Upgrade Group status changes to Active, then updates to show the current upgrade progress (in percent complete).
  - The Group Device List status shows “Entering Download Mode”, then changes to “Downloading” when the firmware is being downloaded to the meter. “Estimated Time Remaining” shows the firmware download progress.
  - You can also check the progress on meters display panel. The meter display shows “Download in progress” and a shows a dynamically increasing number for “Percent Complete” (up to 100%).
22. When the firmware upgrade is complete, the Firmware Update Group status shows Complete (Passed). The Group Device List status shows Successful Download. Click **Finished**.
23. To exit the download firmware program, click **Yes** when prompted to quit DLF.

**NOTE:** A maximum of 6 devices can be upgraded in parallel through DLF.

## Technical assistance

Make sure you include your meter’s model, serial number and firmware version in your email or have it readily available if calling Technical Support.

# Verifying accuracy

## Overview of meter accuracy

All meters are tested and verified at the factory in accordance with International Electrotechnical Commission (IEC) and Institute of Electrical and Electronics Engineers (IEEE) standards.

Your meter typically does not require re-calibration. However, in some installations a final accuracy verification of the meters is required.

## Accuracy test requirements

The most common method for testing meter accuracy is to apply test voltages and currents from a stable power source and compare the meter's readings with readings from a reference device.

### **DANGER**

#### **HAZARD OF ELECTRIC SHOCK, EXPLOSION, OR ARC FLASH**

Verify the device's power source meets the specifications for your device's power supply.

**Failure to follow these instructions will result in death or serious injury.**

## Environment

The meter should be tested at the same temperature as the testing equipment. The ideal temperature is about 23 °C (73 °F). Make sure the meter is warmed up sufficiently before testing.

A warm-up time of 30 minutes is recommended before beginning accuracy verification testing. At the factory, the meters are warmed up to their typical operating temperature before calibration to help ensure that the meters will reach their optimal accuracy at operating temperature.

Most high precision electronic equipment requires a warm up time before it reaches its specified performance levels. Energy meter standards allow the manufacturers to specify meter accuracy derating due to ambient temperature changes and self-heating.

Your meter complies with and meets the requirements of these energy metering standards.

For a list of accuracy standards that your meter complies to, contact your local Schneider Electric representative or download the meter brochure from [www.se.com](http://www.se.com).

## Reference device

To help ensure the accuracy of the test, it is recommended that you use a reference device with a specified accuracy that is 6 to 10 times more accurate than the meter under test. Before you start testing, the reference device should be warmed up as recommended by its manufacturer.

**NOTE:** Verify the accuracy and precision of all measurement equipment used in accuracy testing (for example, voltmeters, ammeters, power factor meters).

## Verifying accuracy test

The following tests are guidelines for accuracy testing your meter; your meter shop may have specific testing methods.

**⚠️ ⚠️ DANGER**

**HAZARD OF ELECTRIC SHOCK, EXPLOSION, OR ARC FLASH**

- Apply appropriate Personal Protective Equipment (PPE) and follow safe electrical work practices. See NFPA 70E, CSA Z462 or other local standards.
- Turn off all power supplying this device and the equipment in which it is installed before working on or in the equipment.
- Always use a properly rated voltage sensing device to confirm that all power is off.
- Do not exceed the maximum ratings of this device.
- Verify the device's power source meets the specifications for your device's power supply.

**Failure to follow these instructions will result in death or serious injury.**

1. Turn off all power supplying this device and the equipment in which it is installed before working on the device or equipment.
2. Use a properly rated voltage sensing device to confirm that all power is off.
3. Connect the test voltage and current source to the reference device. Ensure all voltage inputs to the meter under test are connected in parallel and all current inputs are connected in series.

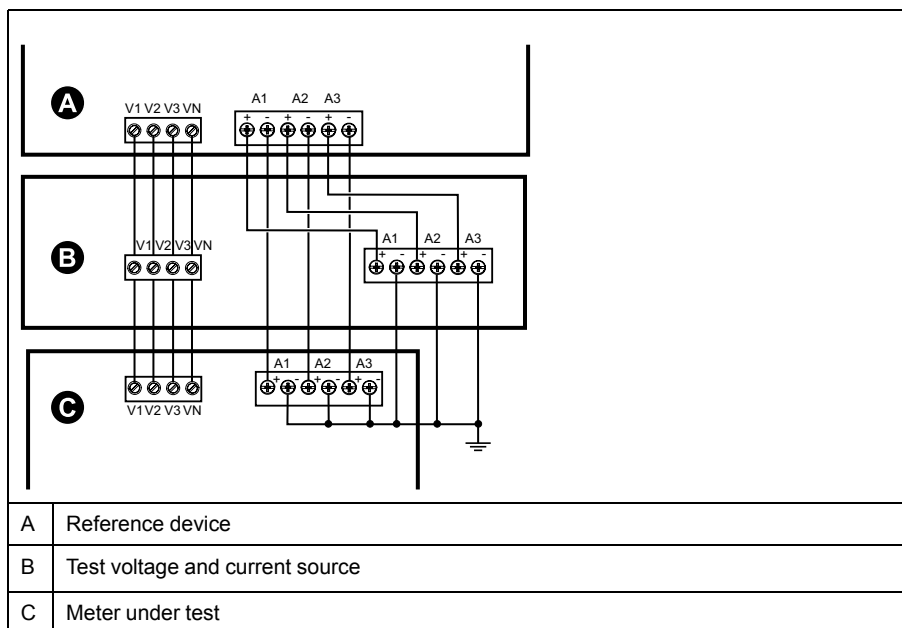

4. Before performing the verification test, let the test equipment power up the meter and apply voltage for at least 30 seconds. This helps stabilize the internal circuitry of the meter.
5. Configure the meter's parameters for verifying accuracy testing.
6. Perform accuracy verification on the test points. Run each test point for at least 30 seconds to allow the test bench equipment to read an adequate number of pulses. Allow 10 seconds of dwell time between test points.

## Percentage error calculation for accuracy verification testing

Accuracy verification testing requires you to calculate the percentage error between the meter being tested and the reference/standard.

Calculate the percentage error for every test point using the following formula:

$$\text{Percentage error} = (\text{MUT} - \text{RSS}) / \text{RSS} \times 100$$

Where:

- MUT= parameter measured by the meter under test
- RSS = Reference Sub Standard (Reference device)

**NOTE:** If accuracy verification reveals inaccuracies in your meter, they may be caused by typical sources of test errors. If there are no sources of test errors present, please contact your local Schneider Electric representative.

## Typical sources of test errors

If you see excessive errors during accuracy testing, examine your test setup and test procedures to eliminate typical sources of measurement errors.

Typical sources of accuracy verification testing errors include:

- Loose connections of voltage or current circuits, often caused by worn-out contacts or terminals. Inspect terminals of test equipment, cables, test harness and the meter under test.
- Meter ambient temperature is significantly different than 23 °C (73 °F).
- Floating (ungrounded) neutral voltage terminal in any configuration with unbalanced phase voltages.
- Inadequate meter control power, resulting in the meter resetting during the test procedure.
- Ambient light interference or sensitivity issues with the optical sensor.
- Incorrect test setup: not all phases connected to the reference device or the energy standard. All phases connected to the meter under test should also be connected to the reference meter/standard.
- Moisture (condensing humidity), debris or pollution present in the meter under test.



# Power factor

The sampled measurements taken at the meter’s voltage and current inputs provide data for calculating power factor.

In a balanced 3-phase alternating current (AC) power system source, the AC voltage waveforms on the current-carrying conductors are equal but offset by one-third of a period (a phase angle shift of 120 degrees between the three voltage waveforms).

## Current phase shift from voltage

Electrical current can lag, lead, or be in phase with the AC voltage waveform, and is typically associated with the type of load — inductive, capacitive or resistive.

For purely resistive loads, the current waveform is in phase with the voltage waveform. For capacitive loads, current leads voltage. For inductive loads, current lags voltage.

The following diagrams show how voltage and current waveforms shift based on load type under ideal (laboratory) conditions.

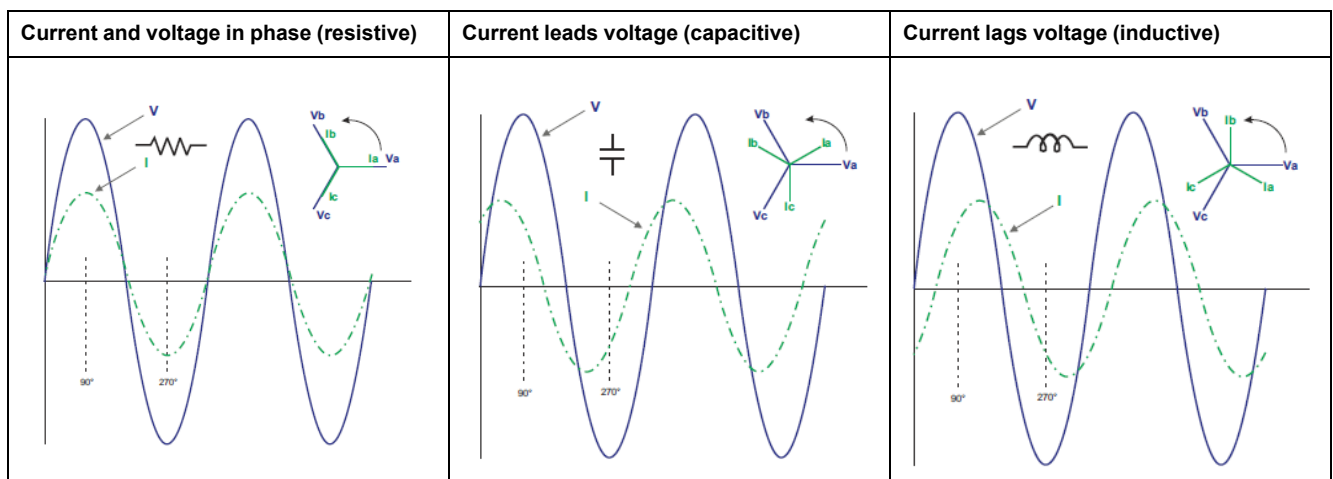

## Power factor (PF)

Power factor (PF) is the ratio of real power (P) to apparent power (S).

Power factor is provided as a number between -1 and 1 or as a percentage from -100% to 100%, where the sign is determined by the convention.

$$PF = \frac{P}{S}$$

An ideal, purely resistive load has no reactive components, so its power factor is one (PF = 1, or unity power factor). Inductive or capacitive loads introduce a reactive power (Q) component to the circuit which causes the PF to become closer to zero.

### True PF

The meter supports true power factor values:

- True power factor includes harmonic content.

## Power factor sign convention

Power factor sign (PF sign) can be positive or negative, and is defined by the conventions used by IEC standards.

### PF sign convention: IEC

PF sign correlates with the direction of real power (kW) flow.

- Quadrant 1 and 4: Positive real power (+kW), the PF sign is positive (+).
- Quadrant 2 and 3: Negative real power (-kW), the PF sign is negative (-).

### IEC -1 to +1 format

Quadrant	PF Range	HMI Representation with sign	PF in RS-485 Comm (Reg IEC format)
Quadrant 1	0 to +1	Inductive (+)	Positive Sign
Quadrant 2	-1 to 0	Capacitive (-)	Negative sign
Quadrant 3	0 to -1	Inductive (-)	Negative Sign
Quadrant 4	+1 to 0	Capacitive(+)	Positive Sign

### Sample screen



### Power factor register format

The meter performs a simple algorithm to the PF value then stores it in the PF register.

Each power factor value (PF value) occupies one floating point register for power factor (PF register). The meter and software interpret the PF register for all reporting or data entry fields according to the following diagram:

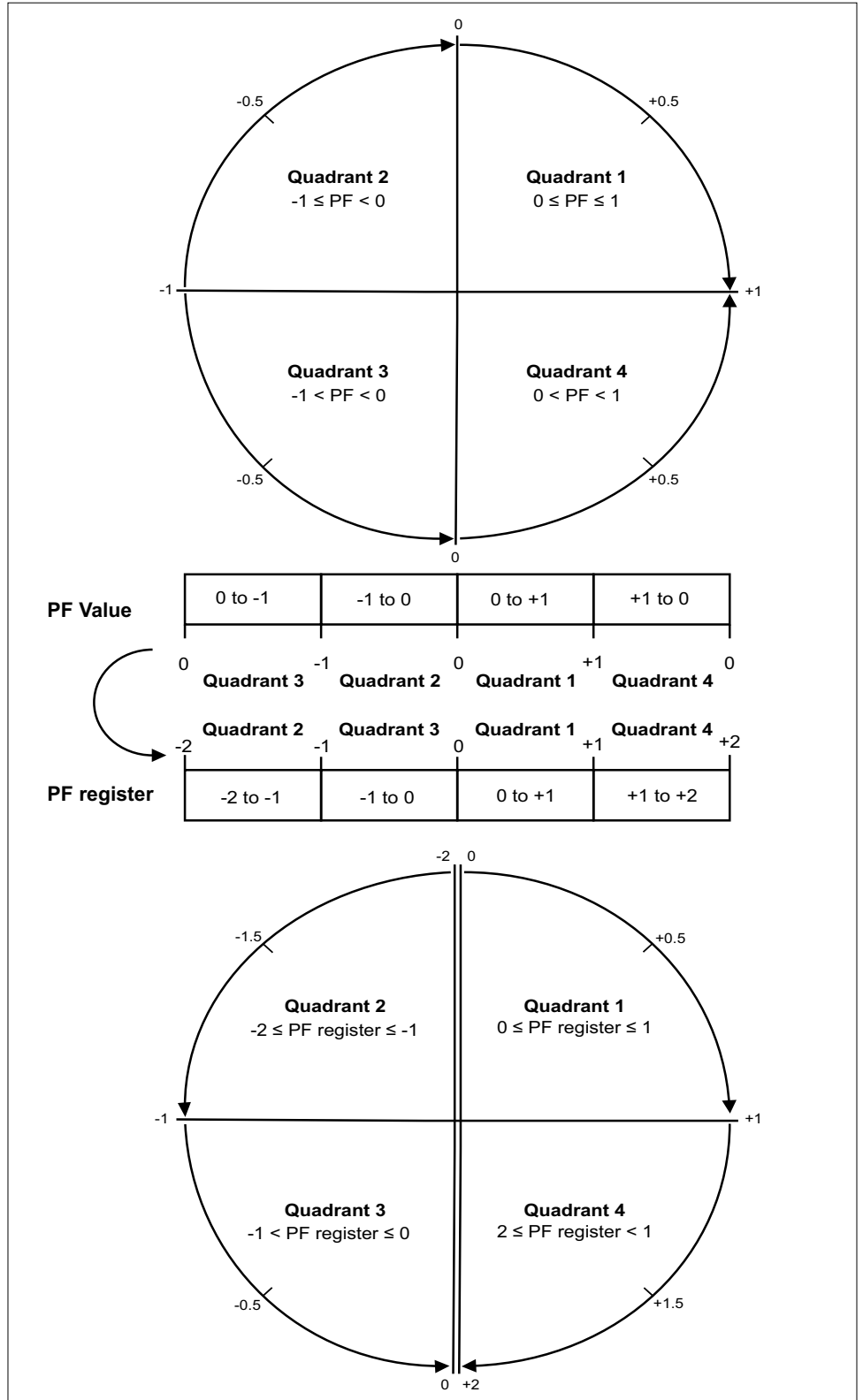

The PF value is calculated from the PF register value using the following formulae:

Quadrant	PF range (in display)	PF register range (through communication)	PF formula
Quadrant 1	0 to +1	0 to +1	PF value = PF register value
Quadrant 2	-1 to 0	-1 to 0	PF value = PF register value

Quadrant	PF range (in display)	PF register range (through communication)	PF formula
Quadrant 3	0 to -1	-2 to -1	PF value = (-2) - (PF register value)
Quadrant 4	+1 to 0	+1 to +2	PF value = (+2) - (PF register value)

# Command interface

## Command interface

The command interface allows you to configure the power meter by sending specific commands using Modbus protocol. Reference the online Modbus register list for meter commands, results, and data types.

 <b>WARNING</b>
<p><b>UNINTENDED OPERATION</b></p> <p>Do not use this device for critical control or protection of persons, animals, property or equipment.</p> <p><b>Failure to follow these instructions can result in death, serious injury, or equipment damage.</b></p>

	Command block	Protected command interface	Unprotected command interface
		Register number	Register number
<b>A</b>	Command	5000	5250
<b>B</b>	Semaphore	5001	5251 (Ignored)
<b>C</b>	Parameters	5002 - 5124	5252 - 5374
	<b>Meter results</b>	<b>Register number</b>	<b>Register number</b>
<b>D</b>	Status	5125	5375
<b>E</b>	Result	5126	5376
<b>F</b>	Data	5127 - 5249	5377- 5499

- **A:** In the **Command** register, enter a meter command.
- **B:** In the **Semaphore** register, when using the protected command interface, enter the semaphore you are given (refer “Using the Protected Command Interface”). The semaphore register cannot be used with unprotected command interface.
- **C:** In the **Parameters** register, enter all parameters for a meter command.
- **D:** The **Status** register displays 0 when the power meter receives a command. Once the command is completed, the status register displays the same value as the command register.
- **E:** The **Result** register indicates if the command was successful, and if not, what is the error that occurred.
- **F:** The **Data** register displays the executed parameters of a successful command and the invalid parameters based on data type of an unsuccessful command.

There are two command interfaces, protected and unprotected, described in the following sections.

## Using protected command interface

To issue a meter command using the protected command interface, you must have a command semaphore.

To get a semaphore, read the semaphore Modbus register. The power meter will return a zero or a nonzero number.

- If the meter shows zero, someone else owns the semaphore. You must wait for the semaphore to be available before sending a command.

- If the meter shows a nonzero number, you own the semaphore. Semaphore is provided once until it is released or has been inactive for approximately 4 minutes. Once you have the semaphore, subsequent reads of the semaphore register will return zero until you release the semaphore or it times out.

To send a meter command using the protected command interface:

1. Read the semaphore register and record the meter response. This is your semaphore.
2. Build the packet to be written to the command block.
3. Write the packet as a Modbus block write (enter the command number, semaphore, and parameters at the same time).

#### Protected command block example

Command block	Register number
Command	2039
Semaphore	5
Parameters	1

4. Monitor the meter response registers for validity and completion.

#### Protected meter response example

Meter response	Register number
Status	2039
Result	0
Data	1

5. Write the semaphore back to the semaphore register to release it for another master to use.

# Specifications

## Device specifications

The specifications contained in this section are subject to change without notice.

For installation and wiring information, refer to the meter installation sheet.

### Mechanical characteristics

IP degree of protection (IEC 60529-1)	Front Display: IP51 Front Display: IP54 with gasket (optional accessory), Meter body: IP30
Panel thickness	5.0 mm (0.196 in) maximum
Mounting position	Vertical
Display type	8 segment alpha-numeric LED, 3 rows with 4 digits per row, 1 column of 12 LEDs to indicate percentage of load connected in system. 4 digits for instantaneous parameters with auto scrolling and auto range
Keypad	4 button
Front panel LED indicators	Red LED (energy pulse output) Green LED (heartbeat / serial communications activity)
Dimensions W x H x D	96 (H) x 96 (W) x 49 (D)

### Electrical characteristics

#### Measurement accuracy

- IEC 61557-12: PMD/[SD|SS]/K55/1<sup>1</sup> (for firmware version 1.3.0 and higher)

Measurement type	Class of accuracy as per IEC 61557-12	Error
Active energy	Class 1 (Class 1 <sup>2</sup> as per IEC 62053-21)	±1%
Reactive energy	Class 2 (Class 2 as per IEC 62053-23)	±2%
Apparent energy	Class 1	±1%
Active power	Class 1	±1%
Reactive power	Class 1	±1%
Apparent power	Class 1	±1%
Current	Class 1	±0.5%
Voltage (L-L)	Class 1	±0.5%
Voltage (L-N)	Class 1	±0.5%
Frequency	Class 0.05	±0.05% <sup>3</sup> and ±0.2% <sup>4</sup>
Power factor	Class 1	±0.01 Count
THD	Class 5	±5%

#### Voltage inputs

VT primary	100 V L-L to 999 kV L-L maximum, starting voltage depends on the VT ratio
V nominal	Up to 277 V L-N / 480 V L-L (selectable VT secondary from 100, 110, 115, 120 to 415 V L-L)

- This Commercial reference METSEDM6000HCL10NC is not complaint with IEC 61557-12: PMD/[SD|SS]/K55/1
- Additional error of ± 2% between 10 mA to 50 mA, ± 1 % between 50 mA to 100 mA
- For frequency nominal 50 / 60 Hz ± 2 Hz
- For frequency range from 30 to 48 Hz, 52 to 58 Hz and 62 to 70 Hz

**Voltage inputs (Continued)**

Measured voltage with full range	35 to 600 V AC L-L
Permanent overload (withstand)	750 V L-L, continuous
Operating voltage range with accuracy	80-480 V L-L $\pm$ 10%, Category III
Impedance	$\geq$ 5 M $\Omega$
Frequency	50 / 60 Hz nominal $\pm$ 2 Hz
VA burden	$\leq$ 0.2 VA at 240 V AC L-N at 50Hz

**Current inputs**

CT primary	1 A to 32767 A, programmable
CT secondary	1 A or 5 A
Operating current range with accuracy	10 mA to 6 A <i>Additional error of <math>\pm</math> 2% between 10 mA to 50 mA, <math>\pm</math> 1% between 50 mA to 100 mA)</i>
Measured Amps with full range	5 mA to 10 A
Suppression current (to disregard negligible load)	5 mA to 99 mA
Permanent overload (withstand)	Continuous 10 A, 10 s/hr 50 A, 1 s/hr 500 A
Impedance	$<$ 0.3 m $\Omega$
Frequency range	50 / 60 Hz $\pm$ 2 Hz
VA burden	$\leq$ 0.1 VA at 5 A, 50 Hz

**AC control power**

Operating range	48 to 277 V L-N AC $\pm$ 10%
Burden	$\leq$ 4V A at 240 V L-N, 50 Hz
Frequency	50 / 60 Hz nominal (45 to 65 Hz operating range)
Ride-through time	200 ms at 240 V L-N, 50Hz (at Ambient condition)

**DC control power**

Operating range	48 to 277 V DC $\pm$ 10%
Burden	$\leq$ 3 W at 240 V DC
Ride-through time	120 ms at 240 V DC (at Ambient condition)

**Displays update**

Instantaneous / RMS parameters	1 s
--------------------------------	-----



### Power system configuration

Phase labelling	Configurable to 123, ABC, rst, pqr or ryb	
Wiring configuration	<b>Using display:</b> 1PH, 2W, LN 1PH, 2W, LL 1PH, 3W, LL with N (2-phase) 3PH, 3W, Delta, Ungrounded 3PH, 4W, Wye Grounded	<b>Using ION Setup:</b> 3PH, 3W, Delta, Corner Grounded 3PH, 3W, Wye, Ungrounded 3PH, 3W, Wye Grounded 3PH, 3W, Wye, Resistance Grounded 3PH, 4W, Open Delta, Center-Tapped 3PH, 4W, Delta, Center-Tapped 3PH, 4W, Wye, Ungrounded 3PH, 4W, Wye, Resistance Grounded

### Environmental characteristics

Operating temperature	-10° to +60° C (+14° ... +140° F)
Storage temperature	-20° to +70° C (-4° ... +158° F)
Humidity rating	5 to 95 % RH non-condensing
Pollution degree	2
Attitude	≤ 2000 meters (6561 ft), Category III
Product life	> 7 years
Insulation category	Double insulation for user accessible parts
Location / mounting	Not suitable for wet locations For indoor use only Must be permanently connected and fixed

### EMC (electromagnetic compatibility)\*

Electrostatic discharge	IEC 61000-4-2
Immunity to radiated field	IEC 61000-4-3
Immunity to fast transients	IEC 61000-4-4
Immunity to impulse waves	IEC 61000-4-5
Conducted immunity	IEC 61000-4-6
Immunity to magnetic field	IEC 61000-4-8
Immunity to voltage dips	IEC 61000-4-11
Emissions (IEC61326-1)	Emissions FCC Part 15 Class A/CE

\* - Tested as per IEC 61326-1 standard

### Safety

Europe	CE, as per IEC 61010-1 Edition-3
US and Canada	cULus per UL 61010-1 CAN / CSA-C22.2 IEC 61010-1 Edition-3, for 480 V AC L-L
Measurement category (Voltage and Current inputs)	CAT III up to 480 V L-L
Overvoltage category (Control power)	CAT III up to 300 V L-N

Dielectric	As per IEC / UL 61010-1 Edition-3
Protective Class	II, Double insulated for user accessible parts
Green premium	EOL, REACH , PEP, RoHS complied
Other certification	RCM and EAC for Russia

## Communications

RS-485 port	<p>Modbus RTU: 2-Wire, 4800, 9600, 19200 or 38400 baud</p> <p>Parity - Even, Odd, None</p> <p>1 stop bit if parity is Odd or Even, 2 stop bits if none</p> <p>DLF3000: Firmware update through communication port</p>
Isolation	2.5 kV RMS, double insulated

## Other specifications

Protection features	Password protected for set-up parameters, energy clearing, and other integrated data
Display language	English
Technical publication	<p>Printed multi-lingual installation sheet (IS / QSG) supplied with meter (EN, ES, FR, DE, PT, RU, TR, ZH)</p> <p>User manual available on website (EN, ES, TR, and ZH)</p>

# China Standard Compliance

This product complies with the following standard(s) in China:

IEC 61010-1:2010 Safety requirements for electrical equipment for measurement, control, and laboratory use - Part 1: General requirements
-------------------------------------------------------------------------------------------------------------------------------------------

Schneider Electric  
35 rue Joseph Monier  
92500 Rueil Malmaison  
France

+ 33 (0) 1 41 29 70 00

[www.se.com](http://www.se.com)

As standards, specifications, and design change from time to time,  
please ask for confirmation of the information given in this publication.

© 2022 – Schneider Electric. All rights reserved.

QGH1315603-05