



**WEICON TOOLS®**

No.1 in Form & Funktion

Catalogue 



# STRIPPING TOOLS



reddot winner 2020



Download Now



www.weicon.com/app



www.weicon-tools.com

V 1.21



Management System  
ISO 9001:2015  
ISO 14001:2015

www.tuv.com  
ID 9108636595



**FAMILY BUSINESS  
SINCE 1947**

We develop, produce and distribute an extensive range of stripping tools. This includes cable knives, wire strippers, dismantling and multi-functional tools. Our tools have been developed for accurate, fast and safe stripping of all common cable types. They carry the GS seal of TÜV Nord and were developed under the aspects of work safety. The tools are specifically tailored to the needs of professional users, are found in both, crafts and industrial use, and are also suitable for domestic use.

Besides the WEICON TOOLS, WEICON produces special chemo-technical products for the industry. The product range of the company includes special adhesives and sealants, technical sprays as well as high performance assembly pastes and greases for all areas of industry - from the production, repair and maintenance to servicing.

The company headquarters are located in Muenster, Germany. WEICON has subsidiaries in Dubai, Canada, Turkey, Romania, South Africa, Singapore, the Czech Republic, Spain and in Italy and is represented by WEICON partners in more than 120 countries all over the world.



Fast and individual service



Strong sales support



Next day delivery



Management System  
ISO 9001:2015  
ISO 14001:2015  
[www.tuv.com](http://www.tuv.com)  
ID 9108636595



Member of the Association of German Tool Manufacturers



For more information on all WEICON products, visit [www.weicon.com](http://www.weicon.com)

**Content**

Content	Page
WEICON TOOLS.....	4
<b>Cable Strippers</b> .....	6
• S 4 - 28.....	7
• S 4 - 28 Multi.....	7
• C 4 - 16.....	9
• C 8 - 27.....	9
• C 4 - 28.....	9
• No. 4 - 16.....	9
• No. 8 - 27.....	9
• No. 4 - 28 H.....	9
• No. 4 - 28 G.....	9
• No. 28 - 35.....	9
• No. 35 - 50.....	9
<b>Wire Strippers</b> .....	10
• No. 5.....	10
• No. 5 Classic.....	11
• No. 6.....	11
• No. 7 Magic.....	12
• No. 7 F.....	13
• Precision Wire Stripper S.....	14
• ESD Precision Wire Stripper.....	15
• Fibre Optic Stripper.....	15
<b>Stripping Tools</b> .....	16
• Round Cable Stripper No. 13.....	16
• Round Cable Stripper No. 13 Classic.....	16
• Quadro-Stripper No. 16.....	17
• Coax-Stripper No. 1 F Plus.....	18
• Coax-Stripper No. 2.....	19
• Combi-Coax No. 3.....	19
• Cat Cable-Stripper No. 10.....	20
• Stripper No. 2 Cat.....	21
<b>Multi-Purpose Strippers</b> .....	22
• Mini-Duo No. 150.....	22
• Duo-Stripper No. 200.....	22
• Duo-Crimp No. 300.....	23
• Multi-Stripper No. 400.....	24
• Data-Strip No. 30.....	25
• Stripper No. 100.....	25
<b>Tool Sets</b> .....	26
• Starter-Set Pro.....	26
• Crimp-Set Pro.....	27
• Electrical Installation Sets.....	28
<b>Special Tools</b> .....	30
• Mini-Solar No. 3.....	30
• Wire Stripper No. 7 Solar.....	30
• Cable Scissors No. 35.....	31
• LSA Sensor No. 40.....	31
• H.D. No. 1000.....	32
• Dismantling Tool No. 25.....	32
• Cable Stripper No. 4 - 29 Spiral.....	32
• Easy Opener®.....	33
• Multi-Opener.....	33
<b>Other</b> .....	34
• Spare Parts.....	34
• Selling Aids.....	35
• Cable Overview.....	36
• Application Examples.....	38
• Certificates.....	40
• Stripping Tools for Private Label.....	41
• Product Overview.....	42



Scan your way to the video!

You will find QR codes on our product pages that lead directly to our application videos!

With kind support from



# WEICON TOOLS®



Member of the German Tool Industry Association



We develop, manufacture and distribute high-quality wire stripping and other special tools for the industry and professional users and can look back on almost 50 years of success by now.

We present these tools at more than 40 fairs and trade shows every year, all over the world. We keep in constant contact with our users, who tell us about new developments in their work processes and, that way, give us ideas and requests for new or improved WEICON TOOLS. This exchange of information generates a process that regularly results in product innovations and modifications and therefore enables us to constantly offer our customers the perfectly engineered and up-to-date solutions they need.



Discover our WEICON TOOLS®



We produce **SUSTAINABLY!**



Since the beginning of 2020, we have been packaging our WEICON TOOLS products in recyclable cardboard boxes. These will come in three different sizes in the future to protect all tools produced by our Muenster-based family business.

Quality and continuity "made in Germany"  
**INNOVATIVE AND RELIABLE!**



reddot winner 2020



In the development of our high-quality stripping tools, we have been working together with the company Krampe from Ascheberg-Herbern near Muenster since 1990.

Our consistent key focus in the production process is on precision to ensure that the products we offer are always of exceptional quality.

Our products are made of high-quality materials, hold numerous certificates and are characterised by their outstanding functionality and durability.



Discover our  
**WEICON TOOLS®**



## Cable Strippers S 4 - 28

- ▶ completely ergonomic & fully insulated
- ▶ continuous regulation and easy to operate adjusting wheel
- ▶ precise, quick and safe stripping

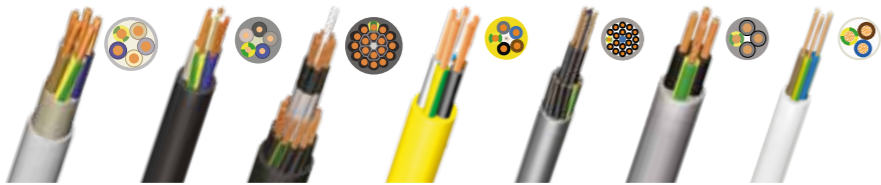

EU.Pat.no. 07114242.6

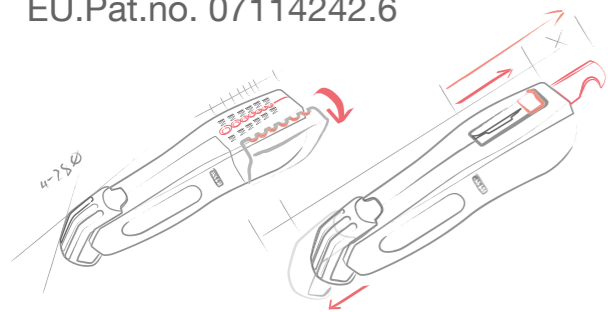

**Working range  
4 - 28 mm Ø**

“ Our S4 - 28 range is certainly something special. There are no other comparable tools on the market. The right cable stripper can be found for almost any application area thanks to the different types.

Its extraordinary shape ensures a safe and comfortable grip. Furthermore, the retractable blade of the S 4 - 28 is a milestone in the area of safety at work.

Gerold Specking  
Product Manager  
WEICON TOOLS

”

### No. S 4 - 28 Multi

Stripping function integrated in the housing

- ▶ stripping of all standard flexible and solid cables with a cross-diameter between 0,5 and 6 mm<sup>2</sup>

mm	g	mm <sup>2</sup>	Ømm	Art.-No.
145	61	0,5 - 6 (20 - 10 AWG)	4 - 28	50057328



### No. S 4 - 28

Safe due to retractable hook blade

- ▶ the blade can be locked in both positions

mm	g	mm <sup>2</sup>	Ømm	Art.-No.
145	72	-	4 - 28	50055328



## Cable Strippers 4 - 28

- ▶ completely ergonomic & fully insulated
- ▶ continuous regulation and easy to operate adjusting wheel
- ▶ precise, quick and safe stripping

Discover our  
**WEICON TOOLS®**

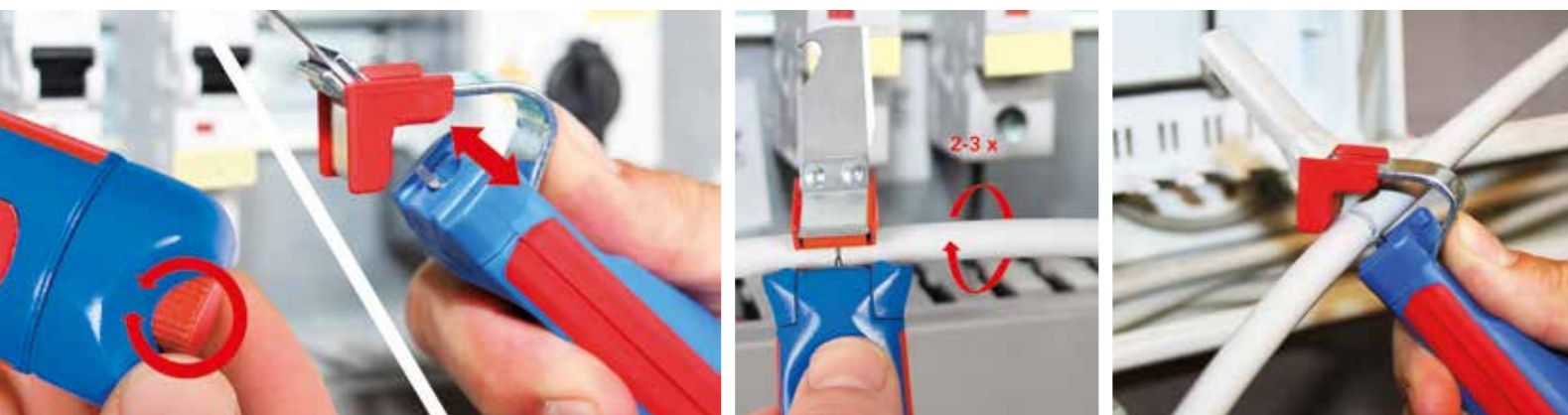

- ① Setting screw
- ② Inner blade
- ③ Bracket with or without blade
- ④ POM part
- ⑤ Cap (on cable stripper with blade)
- ⑥ Outer casing with anti-slip 2-component handle
- ⑦ Closure cap

### Cable Strippers

	↔ mm	g	Ømm	Art.-No.	QR
<b>No. 4 - 16</b>	140	84	4 - 16	50050116	QR
<b>No. 8 - 27</b>	140	92	8 - 28	50050227	QR
<b>No. 4 - 28 H</b>	185	98	4 - 28 with hook blade	50054328	QR
<b>No. 4 - 28 G</b>	195	104	4 - 28 with straight blade	50054428	QR
<b>No. 28 - 35</b>	170	87	28 - 35	50050435	QR
<b>No. 35 - 50</b>	180	90	35 - 50	50050450	QR



### Cable Strippers

	↔ mm	g	Ømm	Art.-No.
<b>No. C 4 - 16</b>	135	67	4 - 16	50053116
<b>No. C 8 - 27</b>	135	69	8 - 28	50053227
<b>No. C 4 - 28</b>	180	80	4 - 28 with hook blade	50053328





## Wire Strippers

Automatic wire strippers for all common stranded and solid conductors. A scanning system adjusts automatically to the required wire diameter, and thus permits fast and simple dismantling and stripping.

Discover our  
**WEICON TOOLS®**



### No. 7 Magic

The all-rounder for stripping and dismantling  
Pat.no. EP 1 671 407 B1

- ▶ for many different cable types in building installation
- ▶ precise work with optical length scale
- ▶ integrated, well accessible side cutter up to 3 mm Ø

mm	g	Round cables	mm <sup>2</sup>	Art.-No.
170	217	flexible	0,5 - 16 (20 - 6 AWG)	51000007
		solid	0,5 - 10 (20 - 8 AWG)	



VIDEO



### No. 7-F

Stripping and dismantling of all standard flat cables  
Pat.no. EP 1 671 407 B1

- ▶ precise work with optical length scale
- ▶ integrated, well accessible side cutter up to 3 mm Ø

mm	g	mm <sup>2</sup>	Art.-No.
170	220	flat cables 0,75 - 4 (18 - 11 AWG)	51001007



## Working Range Wire Strippers:

Outside diameter in mm	0,1270	0,1430	0,1600	0,1800	0,2020	0,2270	0,2550	0,2860	0,3210	0,3610	0,4050	0,4550	0,5110	0,5730	0,6440	0,7230	0,8120	0,9120	1,0240	1,15	1,29	1,45	1,63	1,83	2,05	2,30	2,59	2,91	3,26	3,67	4,11	4,62	5,19	5,83	6,54	7,35	8,25					
Cross section in mm <sup>2</sup>	0,0123	0,0161	0,0200	0,0252	0,0320	0,0400	0,0503	0,0646	0,0804	0,1020	0,1280	0,1630	0,2050	0,2590	0,3240	0,4120	0,5190	0,6530	0,8230	1,04	1,31	1,65	2,08	2,63	3,31	4,15	5,26	6,62	8,34	10,6	13,3	16,8	21,2	26,7	33,6	42,4	53,4					
AWG number	36	35	34	33	32	31	30	29	28	27	26	25	24	23	22	21	20	19	18	17	16	15	14	13	12	11	10	9	8	7	6	5	4	3	2	1	0					
Wire Stripper No. 5																																										
Wire Stripper No. 5 Classic																																										
Wire Stripper No. 6																																										
flexible																																										
Wire Stripper No. 7 Magic																																										
solid																																										
outer sheath																																										
Wire Stripper No. 7-F																																										
Precision Wire Stripper S																																										
ESD Precision Wire Stripper																																										
Fibre Optic Stripper																																										

## Wire Strippers

Automatic wire strippers for all common stranded and solid conductors. A scanning system adjusts automatically to the required wire diameter, and thus permits fast and simple dismantling and stripping.

Discover our  
**WEICON TOOLS**



**Global innovation**



**reddot winner 2020**



DBGM 20 2019 107 281.4

### Precision Wire Stripper S

Fast, easy and precise stripping of thin wires and conductors

- ▶ stripping range from 0,12 mm - 0,8 mm (36 - 20 AWG)
- ▶ scanning system adjusts automatically to the required wire diameter
- ▶ precise working thanks to adjustable length stop from 5 - 45 mm
- ▶ professional stripping technology, suitable for right- and left-handed users



mm	g	Round cables	Ø	Art.-No.
112	45	flexible solid	0,12 mm - 0,8 mm 0,12 mm - 0,8 mm	51000002



### ESD Precision Wire Stripper **NEW**



Fast and easy removal of wires and conductors

- ▶ for working in electrostatic protected areas (ESD safe workspace/ ESD protected area)
- ▶ the tool complies with the DIN EN 61340-5-1 standard
- ▶ stripping range from 0,12 - 0,8 mm (36 - 20 AWG)
- ▶ scanning system adjusts automatically to the required conductor cross section
- ▶ precise working thanks to adjustable length stop from 5 - 45 mm
- ▶ professional cable stripping technology
- ▶ suitable for right- and left-handed users

mm	g	Round cables	Ø	Art.-No.
112	45	flexible solid	0,12 mm - 0,8 mm 0,12 mm - 0,8 mm	51001002

ESD = dissipative ESD material protects against electrostatic discharge



### Fibre Optic Stripper **NEW**

Fast and easy stripping of fibre optic primary coatings 200 - 250 µm

- ▶ for removing the primary coating on fibre optic cables Ø 0,125 mm
- ▶ blade Ø 0,16 mm, opening for cable insertion Ø 0,35 mm
- ▶ precise working thanks to adjustable length stop from 5 - 45 mm
- ▶ professional cable stripping technology
- ▶ suitable for right- and left-handed users



mm	g	Cable type	Ø	Art.-No.
112	45	fibre optic Ø 0,125 mm	primary coating Ø 0,200 - 0,250 mm	51002002

LWL primary coating  
Ø 0,200 - 0,250 mm  
(200 - 250 µm)

fibre optic  
Ø 0,125 mm (125 µm)

### Working Range Wire Strippers:

Outside diameter in mm	0,1270	0,1430	0,1600	0,1800	0,2020	0,2270	0,2550	0,2860	0,3210	0,3610	0,4050	0,4550	0,5110	0,5730	0,6440	0,7220	0,8120	0,9120	1,0240	1,15	1,29	1,45	1,63	1,83	2,05	2,30	2,59	2,91	3,26	3,67	4,11	4,62	5,19	5,83	6,54	7,35	8,25				
Cross section in mm²	0,0123	0,0161	0,0200	0,0252	0,0320	0,0400	0,0503	0,0646	0,0804	0,1020	0,1280	0,1630	0,2050	0,2590	0,3240	0,4120	0,5190	0,6530	0,8230	1,04	1,31	1,65	2,08	2,63	3,31	4,15	5,26	6,62	8,34	10,6	13,3	16,8	21,2	26,7	33,6	42,4	53,4				
AWG number	36	35	34	33	32	31	30	29	28	27	26	25	24	23	22	21	20	19	18	17	16	15	14	13	12	11	10	9	8	7	6	5	4	3	2	1	0				
Wire Stripper No. 5																																									
Wire Stripper No. 5 Classic																																									
Wire Stripper No. 6																																									
flexible																																									
Wire Stripper No. 7 Magic																																									
solid																																									
outer sheath																																									
Wire Stripper No. 7-F																																									
Precision Wire Stripper S																																									
ESD Precision Wire Stripper																																									
Fibre Optic Stripper																																									



## Stripping Tools

Our stripping tools enable the safe and convenient stripping of a range of different cable types.

The flexible tools can even be used in areas difficult to access and always provide precise results.

### Round Cable Stripper No. 13

Safe work with the ergonomic anti-slip handle shape

- ▶ for all standard round cables
- ▶ flush stripping, even in hard-to-reach areas
- ▶ it is not necessary to adjust the cutting depth

mm	g	mm <sup>2</sup>	Ømm	Art.-No.
140	48	-	6 - 13	52000013



Now with  
length stop

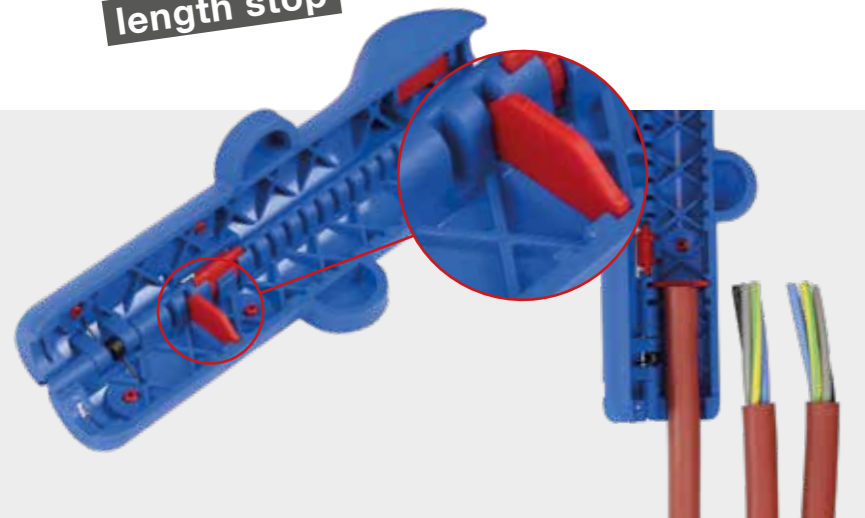

### Round Cable Stripper No. 13 Classic

Safe work with the ergonomic anti-slip handle shape

- ▶ for all standard round cables
- ▶ flush stripping, even in hard-to-reach areas
- ▶ it is not necessary to adjust the cutting depth

mm	g	mm <sup>2</sup>	Ømm	Art.-No.
120	44	-	8 - 13	52003013

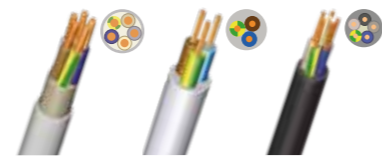
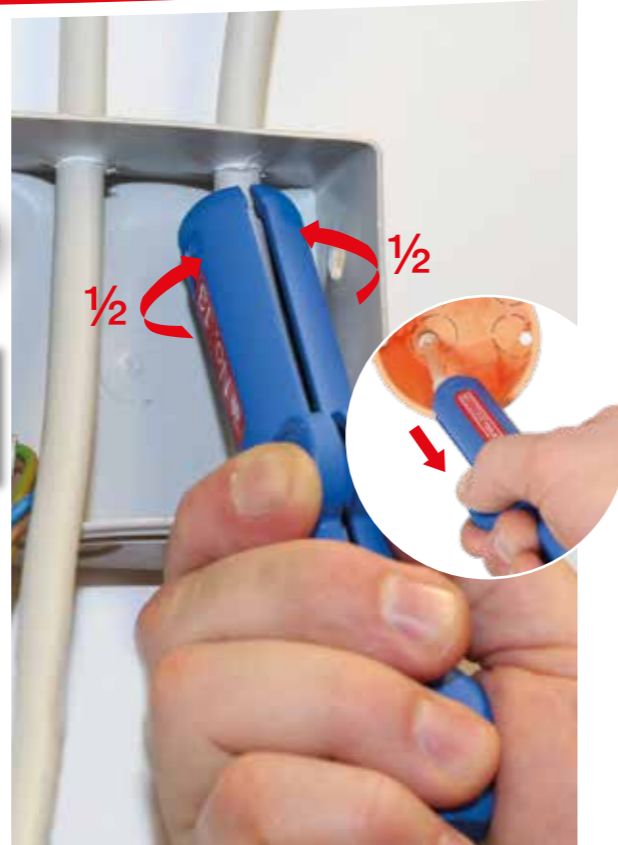

### Quadro-Stripper No. 16

Multifunctional with optimised cable routing

- ▶ circular and longitudinal cutting - stripping - cutting
- ▶ exchangeable hook blade, firmly locked in any position
- ▶ anti-slip handle shape

mm	g	mm <sup>2</sup>	Ømm	Art.-No.
125	53	0,5 - 6 (20 - 10 AWG)	8 - 13	52000016

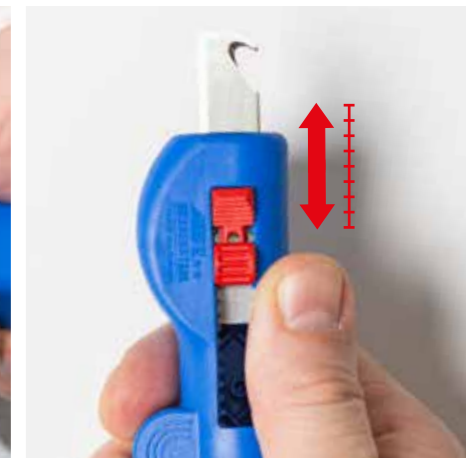

”

No. 16, 13 and 10 are particularly easy to handle thanks to their design. The ergonomic design ensures a safe gripping of the tool, so you won't slip off.

This makes daily work easier and also increases work safety.

Stephan Krampe  
Managing Director  
Krampe GmbH & Co.KG



## Stripping Tools

Our stripping tools enable the safe and convenient stripping of a range of different cable types.

The flexible tools can even be used in areas difficult to access and always provide precise results.

### Coax-Stripper No. 1 F Plus

Quick dismantling and stripping of coaxial cables with only one working step

- ▶ space-saving assembly and disassembly of F-connectors due to integrated open hexagon wrench with 11 mm width across flats
- ▶ gripping jaws for screwing F-connectors onto the cable
- ▶ changeable module inserts via click system



DBGM 20 2017 107 094



mm	g		Ømm	Art.-No.
125	47	for compression connectors	6,0 - 8,0	52001001
125	47	for F-screw connectors	6,0 - 8,0	52000001
125	47	for compression connectors*	4,0 - 5,0	52002001

\*for mini coaxial cables

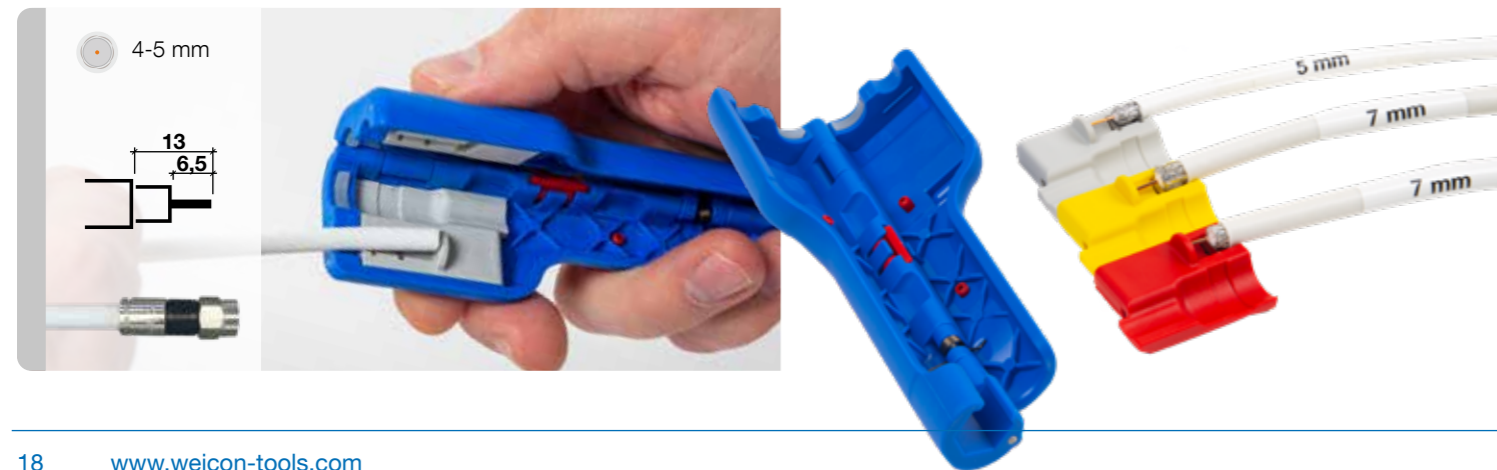

VIDEO



**MODIFIED DESIGN**

### Coax-Stripper No. 2

Good handling due to ergonomic design

- ▶ two-level stripping of all common coaxial cables
- ▶ there is no need to adjust the cutting depth
- ▶ also suitable for flexible cables
- ▶ length scale (0 - 17 mm) integrated in the housing



mm	g	mm <sup>2</sup>	Ømm	Art.-No.
110	28	-	4,8 - 7,5	52000002

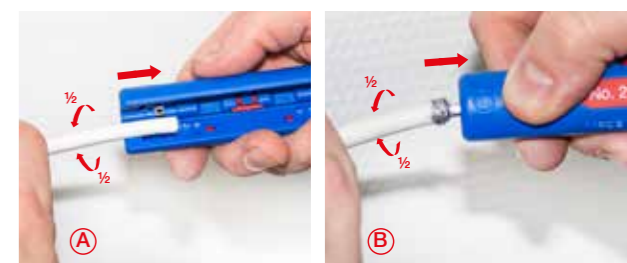
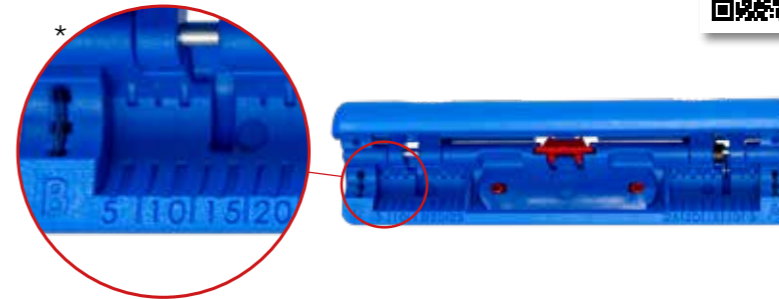

### Combi-Coax No. 3

Parallel blade arrangement allows even faster stripping

- ▶ allows two- or three-level stripping of all common coaxial cables
- ▶ also suitable for flexible cables
- ▶ integrated and well accessible side cutter up to 8 mm Ø

mm	g	mm <sup>2</sup>	Ømm	Art.-No.
125	55	-	4,8 - 7,5	52000003



## Stripping Tools

Our stripping tools enable the safe and convenient stripping of a range of different cable types.

The flexible tools can even be used in areas difficult to access and always provide precise results.

### Cat Cable-Stripper No. 10

Easy and space-saving stripping of data and network cables

- ▶ suitable for e.g. Cat5, Cat6, Cat7 twisted-pair cables (4,5 - 10 mm Ø)
- ▶ integrated length stop, adjustable to the required length
- ▶ safe work with the ergonomic anti-slip handle shape

mm	g	mm <sup>2</sup>	Ømm	Art.-No.
140	48	-	4,5 - 10	52000010

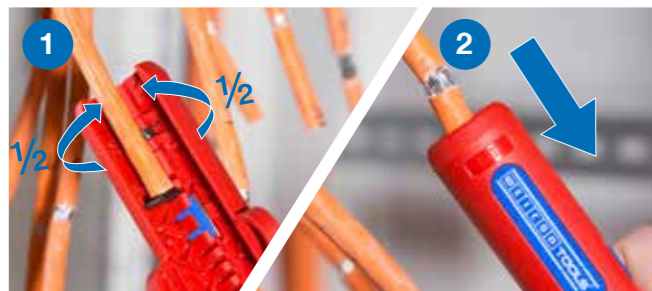

Discover our  
WEICON TOOLS®



### Stripper No. 2 Cat

Easy handling thanks to ergonomic shape

- ▶ for insulated PVC data cables (e.g. Cat5, Cat6, Cat7, twisted-pair cables) with a diameter of 4,5 - 10 mm
- ▶ adjusting the cutting depth manually is not necessary
- ▶ the precise adjustment of the blade removes the outer jacket accurately; with the second blade, the foil shield is slit open carefully and can then be easily removed

mm	mm <sup>2</sup>	Ømm	Art.-No.	
110	28	-	4,5 - 10	52002002

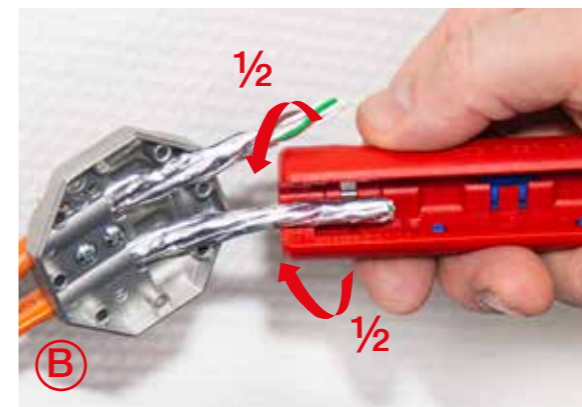
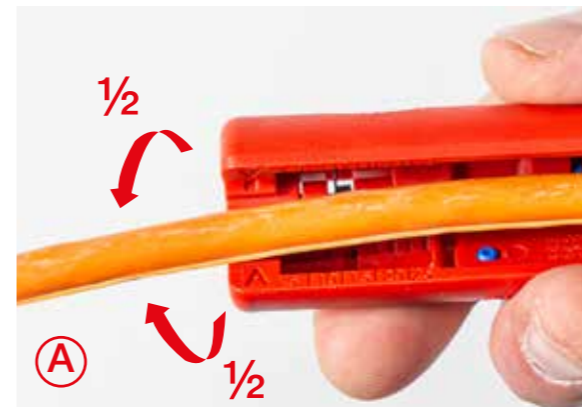

## Multi-Purpose Strippers

WEICON TOOLS multi-purpose strippers provide various functions: circular and longitudinal stripping, dismantling and cutting.

This allows professional dismantling and stripping with just one tool.

### Mini-Duo No. 150

#### Automatic wire stripper

- ▶ allows quick and accurate stripping
- ▶ precise work with integrated length scale
- ▶ easily accessible built-in side cutter for cables up to 6 mm<sup>2</sup>

mm	g	mm <sup>2</sup>	Ømm	Art.-No.
160	112	0,5 - 6 (20 - 10 AWG)	-	51000150



### Duo-Crimp No. 300

#### Stripping and crimping with just one tool

- ▶ insulation removal from 0,5 mm<sup>2</sup> to 6,0 mm<sup>2</sup>
- ▶ two crimping ranges are offered (0,5 - 2,5 mm<sup>2</sup> and 4,0 - 6,0 mm<sup>2</sup>) according to DIN 46228-2
- ▶ integrated, well accessible side cutter up to 6 mm<sup>2</sup>

mm	g	mm <sup>2</sup>	Ømm	Art.-No.
160	116	0,5 - 6 (20 - 10 AWG)	-	51000300



### Duo-Stripper No. 200

#### Professional dismantling and stripping

- ▶ quick and simple stripping from 0,5 mm<sup>2</sup> to 6,0 mm<sup>2</sup>
- ▶ dismantling: working range 4 - 28 mm Ø
- ▶ spare blade in the handle case

mm	g	mm <sup>2</sup>	Ømm	Art.-No.
160	123	0,5 - 6 (20 - 10 AWG)	4 - 28	51000200

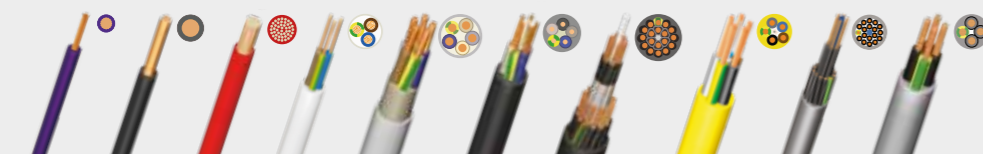

STRIPPING + CRIMPING



## Multi-Purpose Strippers

WEICON TOOLS multi-purpose strippers provide various functions: circular and longitudinal stripping, dismantling and cutting.

This allows professional dismantling and stripping with just one tool.

### Multi-Stripper No. 400

Multifunctional with 4 functions

- ▶ circular cutting - longitudinal cutting - stripping - cutting
- ▶ flush stripping, even in hard-to-reach areas
- ▶ safe and space-saving storage with closing clip

mm	g	mm <sup>2</sup>	Ømm	Art.-No.
155	79	0,5 - 6 (20 - 10 AWG)	8 - 13	51000400



VIDEO

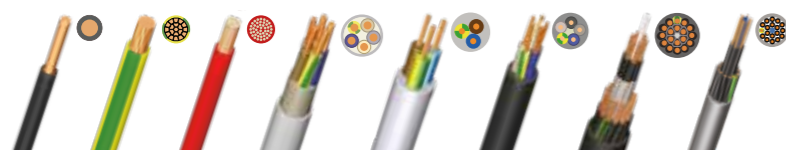

### Data-Strip No. 30



Inner blade can be set to the insulation thickness

- ▶ removal of the outer insulation on data cables
- ▶ stripping of conductors and stranded wires, e.g. telephone lines
- ▶ precise stripping with adjustable length stop (3,5 - 14 mm)
- ▶ integrated, well accessible side cutter up to 8 mm Ø

mm	g	mm <sup>2</sup>	Ømm	Art.-No.
125	60	0,05 - 0,5 (0,2 - 0,8 Ø) (30 - 20 AWG)	4 - 10	52000030



Ø 4 - 10 mm

1

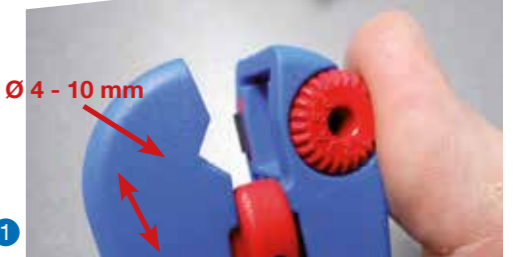

3,5 - 14 mm

2



Ø 0,2 - 0,8 mm

3



### Stripper No. 100



Universal tool for dismantling and stripping

- ▶ for many different cable types in building installation
- ▶ flush stripping on ceilings and walls
- ▶ allows circular and longitudinal stripping

mm	g	mm <sup>2</sup>	Ømm	Art.-No.
140	74	0,5 - 16 (20 - 6 AWG)	4 - 13	51000100

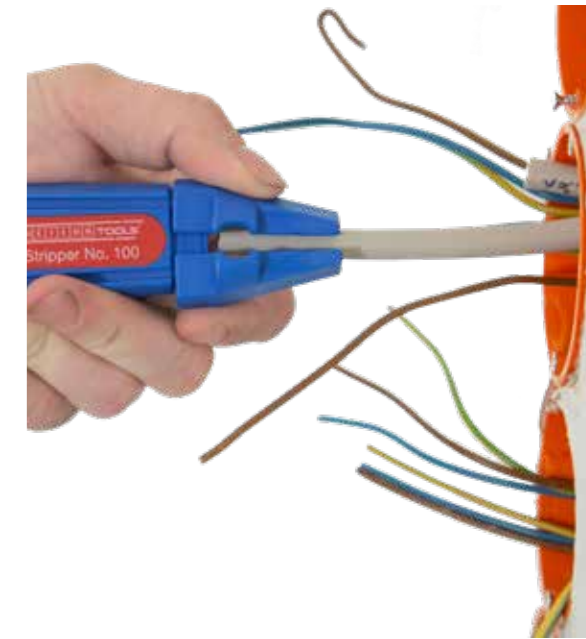
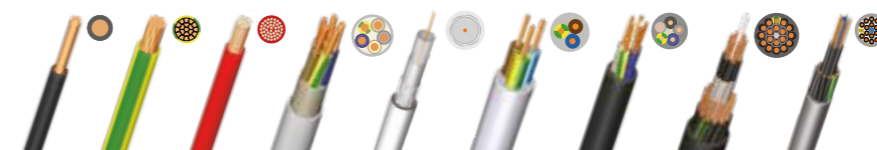

## Tool Sets

With our tool sets, we can offer solutions for almost all industries and many different applications.

### Starter-Set Pro

Ideal selection for home wiring

- ▶ Wire Stripper No. 5
- ▶ Coax-Stripper No. 2
- ▶ Cable Stripper No. S 4-28
- ▶ Round Cable Stripper No. 13

**TOP  
SELECTION**



mm	g	Art.-No.
Length x Width x Height		
255 x 210 x 60	575	52880001

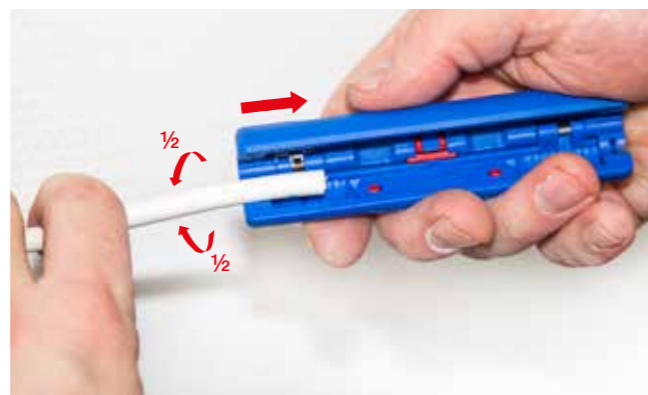

### Crimp-Set Pro

All-round equipment for crimping with wire ends

- ▶ Duo-Crimp No. 300
- ▶ Wire Stripper No. 7 Magic
- ▶ high-quality shaker with 400 wire ends (0,5 - 2,5 mm<sup>2</sup>) according to DIN 46228

mm	g	Art.-No.
Length x Width x Height		
340 x 280 x 55	950	52880002



### Shaker with wire ends

(DIN 46228)

Cross Section	Content	Colour
0,50 mm <sup>2</sup>	50	white
0,75 mm <sup>2</sup>	100	grey
1,00 mm <sup>2</sup>	100	red
1,50 mm <sup>2</sup>	100	black
2,50 mm <sup>2</sup>	50	blue

## Electrical Installation Sets

Industrial solutions for skilled trades:  
Electrical | Heating/Plumbing | Customer Care | Automotive |  
Refrigeration/Air Conditioning | Radio and Television | Home and  
Hobby

### Electrical Installation Set 1

- ▶ Duo-Crimp No. 300
- ▶ Round Cable Stripper No. 13
- ▶ professional crimping of wire ends
- ▶ two crimping ranges of 0,5 - 2,5 mm<sup>2</sup> and 4,0 - 6,0 mm<sup>2</sup>
- ▶ meets the requirements of DIN 46228-21: 1992-02 concerning the pull-off forces
- ▶ side cutter for single wires up to 6 mm<sup>2</sup>
- ▶ stripping of 0,5 - 6,0 mm<sup>2</sup>
- ▶ dismantling of all common round cables 6 - 13 mm
- ▶ flush dismantling e.g. at junction and distribution boxes

**Art.-No.**

52881001



### Electrical Installation Set 3

- ▶ Wire Stripper No. 5
- ▶ Coax-Stripper No. 2
- ▶ automatic wire stripper for 0,2 - 6,0 mm<sup>2</sup>
- ▶ side cutter for single wires up to 2 mm ø
- ▶ adjustable length stop for defined distances at e.g. connection terminals
- ▶ two-level stripping of all common coaxial cables
- ▶ ideal for the installation of SAT systems with multi switches
- ▶ length scale integrated in the housing, e.g. for F-connectors
- ▶ adjustment of cutting depth not necessary

**Art.-No.**

52881003



### Electrical Installation Set 2

- ▶ Wire Stripper No. 5
- ▶ Cable Stripper No. S 4-28
- ▶ automatic wire stripper for 0,2 - 6,0 mm<sup>2</sup>
- ▶ side cutter for single wires up to 2 mm ø
- ▶ adjustable length stop for defined distances at e.g. WAGO-Clamps
- ▶ cable stripper with working range of 4 - 28 mm
- ▶ adjustable cutting blade for round and longitudinal cutting
- ▶ ideal for the construction of switchboards

**Art.-No.**

52881002



### Electrical Installation Set 4

- ▶ Wire Stripper No. 5
- ▶ Round Cable Stripper No. 13
- ▶ automatic wire stripper for 0,2 - 6,0 mm<sup>2</sup>
- ▶ side cutter for single wires up to 2 mm ø
- ▶ adjustable length stop for e.g. special distances
- ▶ dismantling of all common round cables from 6 - 13 mm
- ▶ flush dismantling, e.g. at junction and distribution boxes

**Art.-No.**

52881004



## Special Tools

For a series of unusual applications, we provide you with special tools which meet these requirements. Whether it is the dismantling of large cable diameters, tools for the solar industry or working on high voltage cables, WEICON TOOLS has the solution!



## Especially for the solar sector

### Mini Solar No. 3

Special tools for dismantling and stripping of all common cables in the solar sector

- ▶ quick stripping of all common solar cables with outer diameters from 1,5 mm<sup>2</sup> to 6 mm<sup>2</sup>
- ▶ precise work with adjustable length stop (6 - 28 mm)
- ▶ integrated, well accessible side cutter up to 4 mm<sup>2</sup>

mm	g	mm <sup>2</sup>	Ømm	Art.-No.
125	58	1,5 - 6 (15 - 9 AWG)	-	52002003



### Wire Stripper No. 7 Solar

Special tools for dismantling and stripping of all common cables in the solar sector

- ▶ automatic wire stripper
- ▶ precise work with optical length scale (up to 26 mm)
- ▶ integrated, well accessible side cutter up to 3 mm Ø

mm	g	mm <sup>2</sup>	Art.-No.
170	218	Solar cable 1,5 - 6 (15 - 9 AWG)	51002007



### LSA Sensor No. 40

For the solderless, screwless and no-stripping inserting and simultaneously cutting of wire ends into LSA punch-down blocks

- ▶ with built-in retractable hook and unlocking blade
- ▶ for conductor diameters 0,35 - 0,9 mm and wire diameters 0,7 - 2,6 mm
- ▶ has a sensor for tracing the wire end position

mm	g	Ømm	Art.-No.
185	60	0,35 - 0,9	52000040

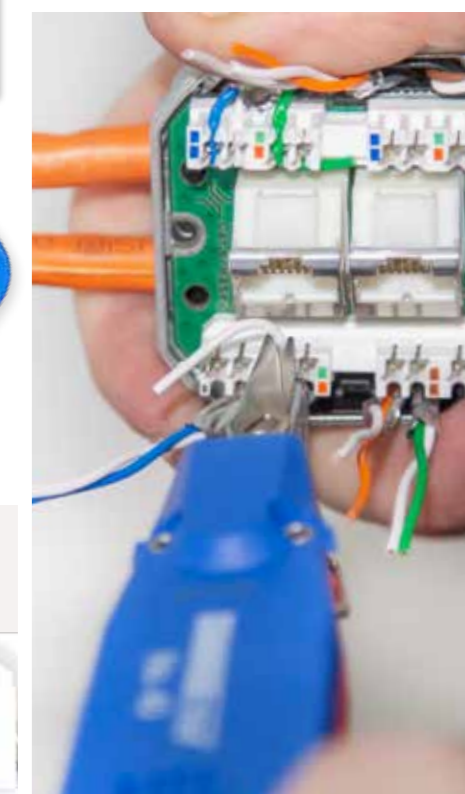

### Cable Scissors No. 35

Cutting - stripping - crimping

- ▶ 2-component handles for increased safety
- ▶ high cutting performance
- ▶ blades made of special stainless steel

mm	g	Cu/Al	Cu/Al	Art.-No.
150	90	<35 mm <sup>2</sup>	<50 mm <sup>2</sup>	52000035

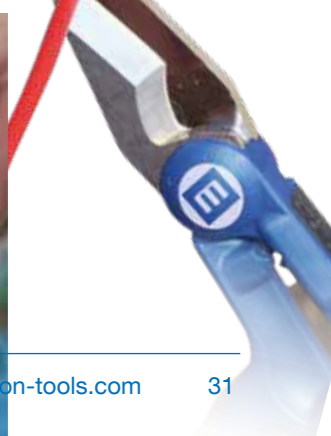
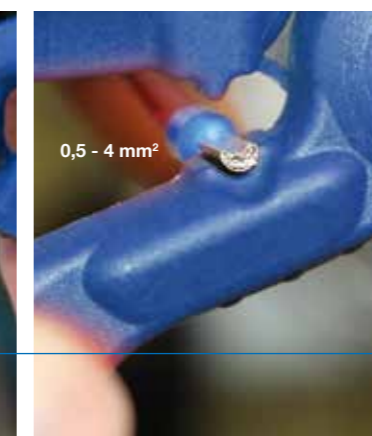



## Special Tools

For a series of unusual applications, we provide you with special tools which meet these requirements. Whether it is the dismantling of large cable diameters, tools for the solar industry or working on high voltage cables, WEICON TOOLS has the solution!



Cable Stripper  
H.D. No. 1000

Working with voltage up to 1000 Volt\*  
Unit testing according to DIN EN 60900

1000 V  
IEC: 60900

- ▶ quick cutting of cables with multiple insulations
- ▶ conductor protection with the curved blade tip
- ▶ good transfer of force due to optimised handle shape

mm	g	Art.-No.
215	93	51001000

\*Tools with safety insulation are basic prerequisites for working on live wires and parts.  
Please always pay attention to the legal regulations and follow the corresponding safety advice!



Cable Stripper No. 4 - 29 Spiral **NEW**

round, longitudinal and circular cutting for soft and rigid cable insulations

- ▶ for all common round cables from 4,5 - 29 mm Ø
- ▶ cutting depth can be set comfortably from 0 - 3 mm with lockable control knob in 0,1 mm steps

mm	g	Ømm	Art.-No.
140	136	4,5 - 29	52000029



Dismantling Tool  
No. 25

For convenient longitudinal and circular cuts

- ▶ safe working thanks to concealed blade
- ▶ wire protection thanks to rounded blade tip
- ▶ easy working even in low temperatures
- ▶ precise, durable, replaceable turning blade

mm	g	mm	mm	Art.-No.
210	163	>25 mm	0 - 5,0 mm	52000025



Multi-Opener



The ideal tool for the gentle opening of sensitive equipment and dismantling of clipped housings

- ▶ no scratching of sensitive surfaces
- ▶ dissipative ESD material protects against electrostatic discharge
- ▶ flexible fibreglass-reinforced polyamide
- ▶ stainless steel blade to remove adhesive residues

mm	g	Surface Resistance	Art.-No.
180	22	approx. 10 <sup>9</sup> Ω	52800000

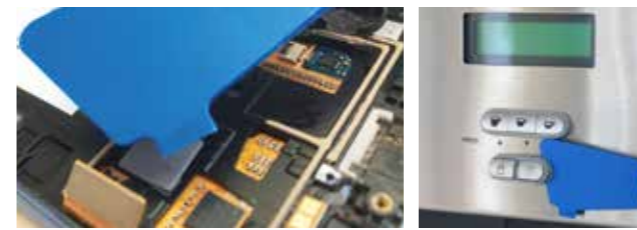

Easy Opener®



Special tool for the gentle disassembly of sensitive components without damaging the material

- ▶ ideal for loosening switches, luminaires or similar components
- ▶ flexible and stable at the same time
- ▶ three surfaces with different material thickness

mm	g	Art.-No.
180	22	52800001



Our  
DIY TIP!



**Spare Parts & Selling Aids**

**Spare Parts for Tools**

Art. No.	Name	PU	
50100002	Spare blade for Cable Stripper series S 4 - 28 <i>Inner blade</i>	1	
50100001	Spare blade for Cable Strippers <i>Inner blade</i>	1	
51100008	Spare blade for No. 200 <i>Inner blade</i>	1	
51100002	Spare blade set No. 5/No. 6 <i>2 blades + 1 screw</i>	1	
51100006	Spare blade set No. 7 Magic <i>2 blades + 4 screws</i>	1	
51100007	Spare blade set No. 7-F <i>2 blades + 4 screws</i>	1	
51100005	Spare blade set No. 7 Solar	1	
52953030	Spare blade set No. 30 Data-Strip <i>1 blade + adjusting screw</i>	1	
51953020	Spare blade set for No. 150 / No. 200 / No. 300	1	
52953020	Spare blade for Dismantling Tool No. 25 <i>Double edge blade</i>	1	
52953050	Spare blade for Cable Stripper 4-29 Spiral	1	
52953040	Hook knife for No. 16 <i>1 hook knife 1 slider + 1 screw</i>	1	
52100008	Inserts for No.1 F Plus 6/4	6	
52100009	Inserts for No.1 F Plus 6.5/6.5	6	
52100010	Inserts for No.1 F Plus 6/4 <i>*for mini coaxial cables</i>	6	



**Stickers**

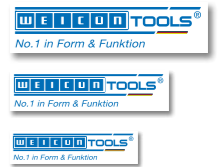

**Poster**



## WEICON TOOLS® Cable Overview

The cable types shown in the table below are only meant to give an overview of the potential application areas of our tools. WEICON TOOLS can also be used on similar cable types in many cases, of course. Furthermore, the application suggestions depend on the material, application area and working range. Our tool recommendation is only a suggestion due to the various materials used by cable manufacturers.

Cable	Name	Example	Suggested application Dismantling	Suggested Application Stripping
	PVC - coated conductor	(N)YM	All Cable Strippers, No. 13, No. 16, No. 100, No. 200, No. 400, No. 7 Magic	No. S 4 - 28 Multi, No. 5, No. 6, No. 7 Magic, No. 7-F, No. 16, No. 100, No. 200, No. 400
	PVC - sheathed cable for low mechanical loads	H05VV-F	All Cable Strippers (working range from 4 mm), No. 3, No. 200, No. 7 Magic	No. 2, No. 3, No. S 4 - 28 Multi, No. 5, No. 6, No. 7 Magic, No. 7-F, No. 16, No. 100, No. 200, No. 400,
	Rubber tube conductor for light mechanical loads	H05RR-F	All Cable Strippers, No. 7 Magic, No. 13, No. 16, No. 100, No. 200, No. 400	No. S 4 - 28 Multi, No. 5, No. 6, No. 7 Magic, No. 7-F, No. 16, No. 100, No. 200, No. 400
	Rubber - control line	(N)FLGöu	All Cable Strippers, No. 7 Magic, No. 13, No. 16, No. 100, No. 200, No. 400,	No. S 4 - 28 Multi, No. 5, No. 6, No. 7 Magic, No. 7-F, No. 16, No. 100, No. 200, No. 400
	PVC - construction cables	XYMM K3	All Cable Strippers, No. 7 Magic, No. 13, No. 16, No. 100, No. 200, No. 400	No. S 4 - 28 Multi, No. 5, No. 6, No. 7 Magic, No. 7-F, No. 16, No. 100, No. 200, No. 400
	PVC - control line		All Cable Strippers, No. 7 Magic, No. 13, No. 16, No. 100, No. 200, No. 400,	No. S 4 - 28 Multi, No. 5, No. 6, No. 7 Magic, No. 7-F, No. 16, No. 100, No. 200, No. 400
	PVC - control line oil resistant	73H05VV5-F	All Cable Strippers, No. 7 Magic, No. 13, No. 16, No. 100, No. 200, No. 400,	No. S 4 - 28 Multi, No. 5, No. 6, No. 7 Magic, No. 7-F, No. 16, No. 100, No. 200, No. 400
	PVC - motor connection cables	SLM 0,6/1 kV	All Cable Strippers, No. 7 Magic, No. 13, No. 16, No. 100, No. 200, No. 400,	No. S 4 - 28 Multi, No. 5, No. 6, No. 7 Magic, No. 7-F, No. 16, No. 100, No. 200, No. 400
	PVC - sheathed cable for medium mechanical loads	H05VV-F	All Cable Strippers, No. 7 Magic, No. 13, No. 16, No. 100, No. 200, No. 400,	No. S 4 - 28 Multi, No. 5, No. 6, No. 7 Magic, No. 7-F, No. 16, No. 100, No. 200, No. 400
	PVC insulated high voltage cables, single and multi-core cables	E-YY	No. 25, No. 1000	---
	PVC insulated cables with aluminium conductor	E-AYY	No. 25, No. 1000	---
	PVC insulated telecommunications sheathed wires 0,6 mm	YYSch	No. 7 Magic	No. 5, No. 6, No. 7 Magic, No. 7-F, Precision Wire Stripper S/ESD
	PVC insulated telecommunications sheathed wires 0,8 mm	YR	No. 7 Magic	No. 5, No. 6, No. 7 Magic, No. 7-F, Precision Wire Stripper S/ESD
	PVC - single wire core conductor	H05V-U	---	No. S 4 - 28 Multi, No. 5, No. 6, No. 7 Magic, No. 7-F, No. 16, No. 100, No. 200, No. 400
	PVC - multiple wire core conductor	H07V-R	---	No. S 4 - 28 Multi, No. 5, No. 6, No. 7 Magic, No. 7-F, No. 100
	PVC - fine wire core conductor	H05V-K	---	No. S 4 - 28 Multi, No. 5, No. 6, No. 7 Magic, No. 7-F, No. 16, No. 100, No. 200, No. 300, No. 400, Precision Wire Stripper S/ESD
	PVC - wiring conductor fine wire	H07V-K	---	No. S 4 - 28 Multi, No. 5, No. 6, No. 7 Magic, No. 7-F, No. 16, No. 100, No. 200, No. 300, No. 400, Precision Wire Stripper S/ESD

Cable	Name	Example	Suggested application Dismantling	Suggested Application Stripping
	PVC ignition cable e.g. in the vehicle industry	AYZL	---	No. 2, No. 3
	Coaxial cables for the transmission of high frequency signals and conductors	RG 59 B/U	No. 1, No. 2, No. 3, No. 100	No. 1, No. 2, No. 3, No. 100
	Coaxial cables (SAT compatible)	2YALGY	No. 1, No. 2, No. 3, No. 100	No. 1, No. 2, No. 3, No. 100
	Special PVC loud speaker cable	26 LFZ-XY	---	No. 7 Magic, No. 7-F
	PVC twin conductor	(H)03VH-H	---	No. 7 Magic, No. 7-F
	PVC flat twin and earth cable		No. 7-F	No. 7-F
	Flat rubber cables for medium mechanical loads		No. 7-F	No. 7-F
	Solar cables	H1Z2Z2-K	Mini-Solar No. 3, No. 7 Solar	Mini-Solar No. 3, No. 7 Solar
	Installation cables for fire alarm systems	JB-Y(ST)Y	No. 2 Cat, No. 10, No. 30	No. 30
	Installation cables for telecommunications systems	F-vYAY	No. 2 Cat, No. 10, No. 30	No. 30, Precision Wire Stripper S/ESD
	Electronic - control lines	LiYY	No. 2 Cat, No. 10, No. 30	No. 30, Precision Wire Stripper S/ESD
	Installation cables for industry electronics	JE-Y(ST)Y Bd	No. 2 Cat, No. 10, No. 30	No. 30, Precision Wire Stripper S/ESD
	BUS cable		No. 2 Cat, No. 10, No. 30	No. 30
	Patch cable with film shield for local networks	LAN 200flex	No. 2 Cat, No. 10, No. 30	No. 30
	Data cable (Cat 7)	LAN 1000	No. 2 Cat, No. 10, No. 30	No. 30
	Rubber core conductor with higher heat resistance	A07RN-R	---	No. 2, No. 3
	Silicone core conductor	SiF	---	No. 2, No. 3
	Fibre optic		---	Fibre Optic Stripper

# WEICON TOOLS® Application Examples



## PHOTOVOLTAIC/SOLAR

**Wire Stripper No. 7 Solar**  
Automatic stripping of solar cables



**Mini-Solar No. 3**  
Stripping of solar cables



## KITCHEN/LIVING ROOM

**Round Cable Stripper No. 13**  
Stripping on cavity wall boxes



**Wire Stripper No. 5**  
Stripping of all common stranded and solid wires



## DIY/WORKSHOP

**Duo-Crimp No. 300**  
Crimping wire end ferrules



**Multi-Stripper No. 400**  
Wire stripping and dismantling



**Precision Wire Stripper S**  
For thin wires and conductors



## LIVING ROOM

**Coax-Stripper No. 1 F Plus**  
Stripping coaxial cables



**LSA Sensor No. 40**  
Installation network socket



**Stripper No. 2 Cat**  
Stripping data cables (e.g. CAT 7)



## UTILITY ROOM

**Cable Stripper S 4-28**  
Removing the outer sheath, e.g. NYM



**Wire Stripper No. 6**  
Stripping of all common stranded and solid wires



**Fibre Optic Stripper**  
Removing the coating of fibre optic cables



## HEATING/AIR CONDITIONING

**Wire Stripper No. 7 Magic**  
Wire stripping and dismantling



**Quadro-Stripper No. 16**  
Wire stripping and dismantling



# WEICON TOOLS® Certificates



Management System  
ISO 9001:2015  
ISO 14001:2015  
[www.tuv.com](http://www.tuv.com)  
ID 9108636595

Further certificates  
on request!

## PRIVATE LABEL TOOLS

We also provide the opportunity to design the tools in a variety of colour combinations and individually with your company print/logo.

We would be pleased to submit a detailed offer.



individual colour combinations



# WEICON TOOLS® Product Overview

## CABLE STRIPPERS



Cable Stripper No. S 4 - 28  
Art.-No. 50055328



Cable Stripper No. S 4 - 28 Multi  
Art.-No. 50057328

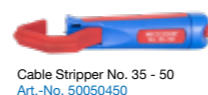

Cable Stripper No. 35 - 50  
Art.-No. 50050450

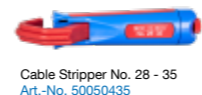

Cable Stripper No. 28 - 35  
Art.-No. 50050435



Cable Stripper No. 4 - 28 G  
Art.-No. 50054428



Cable Stripper No. 4 - 28 H  
Art.-No. 50054328



Cable Stripper No. 4 - 16  
Art.-No. 50050116



Cable Stripper No. 8 - 27  
Art.-No. 50050227



Cable Stripper No. C 4 - 16  
Art.-No. 50053116



Cable Stripper No. C 8 - 27  
Art.-No. 50053227



Cable Stripper No. C 4 - 28  
Art.-No. 50053328

## WIRE STRIPPERS



Wire Stripper No. 5  
Art.-No. 51000005



Wire Stripper No. 5 Classic  
Art.-No. 51003005



Wire Stripper No. 6  
Art.-No. 51000006



ESD Precision Wire Stripper  
Art.-No. 51001002



Wire Stripper No. 7 Magic  
Art.-No. 51000007



Wire Stripper No. 7-F  
Art.-No. 51001007



Precision Wire Stripper S  
Art.-No. 51000002



Fibre Optic Stripper  
Art.-No. 51002002

## STRIPPING TOOLS

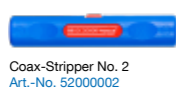

Coax-Stripper No. 2  
Art.-No. 52000002



Stripper No. 2 Cat  
Art.-No. 52002002



Cat Cable-Stripper No. 10  
Art.-No. 52000010

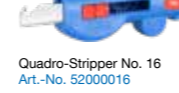

Quadro-Stripper No. 16  
Art.-No. 52000016



Combi-Coax No. 3  
Art.-No. 52000003



Round Cable Stripper No. 13  
Art.-No. 52000013



Round Cable Stripper No. 13 Classic  
Art.-No. 52003013



No. 1 F Plus for screw connectors  
Art.-No. 52000001



No. 1 F Plus F-compression connectors  
Art.-No. 52001001



No. 1 F Plus F-compression connectors  
for mini coaxial cables  
Art.-No. 52002001

Cable Scissors No. 35.....p. 31  
Cable Stripper H. D. No. 1000.....p. 32  
Cable Stripper No. 28 - 35.....p. 9  
Cable Stripper No. 35 - 50.....p. 9  
Cable Stripper No. 4 - 16.....p. 9  
Cable Stripper No. 4 - 28 G.....p. 9  
Cable Stripper No. 4 - 28 H.....p. 9  
Cable Stripper No. 8 - 27.....p. 9

Cable Stripper No. C 4 - 16.....p. 9  
Cable Stripper No. C 4 - 28.....p. 9  
Cable Stripper No. C 8 - 27.....p. 9  
Cable Stripper No. S 4 - 28.....p. 9  
Cable Stripper No. S 4 - 28 Multi.....p. 7  
Cable Stripper No. S 4 - 29 Spiral.....p. 32  
Cat Cable-Stripper No. 10.....p. 22  
Coax-Stripper No. 1 F Plus.....p. 18

Coax-Stripper No. 2.....p. 19  
Combi-Coax No. 3.....p. 19  
Crimp-Set Pro.....p. 27  
Data-Strip No. 30.....p. 25  
Dismantling Tool No. 25.....p. 22  
Duo-Crimp No. 300.....p. 32  
Duo-Stripper No. 200.....p. 22  
Easy Opener.....p. 33

## MULTI-PURPOSE STRIPPERS



Duo-Crimp No. 300  
Art.-No. 51000300



Mini-Duo No. 150  
Art.-No. 51000150



Duo-Stripper No. 200  
Art.-No. 51000200



Multi-Stripper No. 400  
Art.-No. 51000400



Stripper No. 100  
Art.-No. 51000100



Data-Strip No. 30  
Art.-No. 52000030

## SETS



Starter-Set Pro  
Art.-No. 52880001



Crimping-Set Pro  
Art.-No. 52880002



Electrical Installation Set 1  
Art.-No. 52881001



Electrical Installation Set 2  
Art.-No. 52881002



Electrical Installation Set 3  
Art.-No. 52881003



Electrical Installation Set 4  
Art.-No. 52881004

## SPECIAL TOOLS



Cable Stripper H. D. No. 1000  
Art.-No. 51001000



Dismantling Tool No. 25  
Art.-No. 52000025



LSA Sensor No. 40  
Art.-No. 52000040



Cable Scissors No. 35  
Art.-No. 52000035



Mini-Solar No. 3  
Art.-No. 52002003



Wire Stripper No. 7 Solar  
Art.-No. 51002007

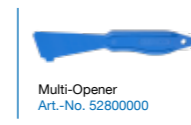

Multi-Opener  
Art.-No. 52800000

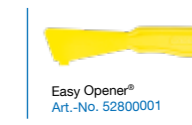

Easy Opener®  
Art.-No. 52800001



Cable Stripper No. 4 - 29 Spiral  
Art.-No. 52000029

Electrical Installation Sets 1/2/3/4.....p. 28  
ESD Precision Wire Stripper.....p. 15  
Fibre Optic Stripper.....p. 15  
Mini-Duo No. 150.....p. 31  
Mini-Solar No. 3.....p. 22  
Stripper No. 100.....p. 30  
Multi-Opener.....p. 33  
Multi-Stripper No. 400.....p. 24

Precision Wire Stripper S.....p. 14  
Quadro-Stripper No. 16.....p. 17  
Round Cable Stripper No. 13.....p. 16  
Round Cable Stripper No. 13 Classic.....p. 16  
Starter-Set Pro.....p. 26  
Stripper No. 100.....p. 25  
Stripper No. 2 Cat.....p. 21  
Wire Stripper No. 5.....p. 10

Wire Stripper No. 5 Classic.....p. 11  
Wire Stripper No. 6.....p. 11  
Wire Stripper No. 7 Magic.....p. 12  
Wire Stripper No. 7 Solar.....p. 30  
Wire Stripper No. 7-F.....p. 13

Note: Work with WEICON TOOLS is only permitted on zero-potential cables and conductors.

Note: Work with WEICON TOOLS is only permitted on zero-potential cables and conductors.

# WEICON TOOLS®

No. 1 in Form & Funktion



**MESSERSTAHL**  
Qualität aus Solingen



WEICON GmbH & Co. KG  
(Headquarters)  
Germany  
phone +49 (0) 251 9322 0  
info@weicon.de

WEICON Middle East L.L.C.  
United Arab Emirates  
phone +971 4 880 25 05  
info@weicon.ae

WEICON Inc.  
Canada  
phone +1 877 620 8889  
info@weicon.ca  
www.weicon.ca

WEICON Kimya Sanayi Tic. Ltd. Şti.  
Turkey  
phone +90 (0) 212 465 33 65  
info@weicon.com.tr  
www.weicon.com.tr

WEICON Romania SRL  
Romania  
phone +40 (0) 3 65 730 763  
office@weicon.com

WEICON SA (Pty) Ltd  
South Africa  
phone +27 (0) 21 709 0088  
info@weicon.co.za

WEICON South East Asia Pte Ltd  
Singapore  
phone (+65) 6710 7671  
info@weicon.com.sg

WEICON Czech Republic s.r.o.  
Czech Republic  
phone +42 (0) 417 533 013  
info@weicon.cz

WEICON Ibérica S.L.  
Spain  
phone +34 (0) 914 7997 34  
info@weicon.es

WEICON Italia S.r.L.  
Italy  
phone +39 (0) 329 235 9592  
info@weicon.it

[www.weicon-tools.com](http://www.weicon-tools.com)

Art.-No. 50900002