Capacitive proximity sensors

XT range

Catalogue



Simply easy!™

Selection guide page 2

- General pages 4 to 7
- Cylindrical, flush mountable. Metal case pages 8 to 11
- Cylindrical, non flush mountable. Plastic case pages 12 to 17
- Product reference index. page 18

Capacitive proximity sensors

XT range

Detection of insulated or conductive materials

Applications: detection of any object irrespective of material or conductivity, for example: metals, minerals, wood, plastic, glass, cardboard, fluids, etc.

Cylindrical sensors, flush mountable, metal case

Detection of insulated or conductive materials: presence, passage of paper, cardboard, glass, etc.



| | | | | |
|-----------------------------|--------------------------------------|------------------|------------------|--------------------|
| Diameter | M12 x 1 | M18 x 1 | M30 x 1.5 | Plain: Ø 32 |
| Case | Nickel copper alloy | | | |
| Sensing distance (Sn) in mm | Flush mountable in metal sensors | | | |
| | 2 | 5 | 10 | 15 |
| | Non flush mountable in metal sensors | | | |
| | - | | | |
| Degree of protection | IP 67 IP 65 | | | |
| Supply | • | | | |
| | - | • | • | • |
| Connection | • | | | |
| | • | • | • | - |
| | - | - | - | - |
| Type reference | XT512B1 • | XT518B1 • | XT530B1 • | XT132B1FAL2 |
| Pages | 8 | | | |

Cylindrical sensors, non flush mountable, plastic case

Detection of insulated or conductive materials
Liquid level control

Application series:
Automatic feed system for livestock

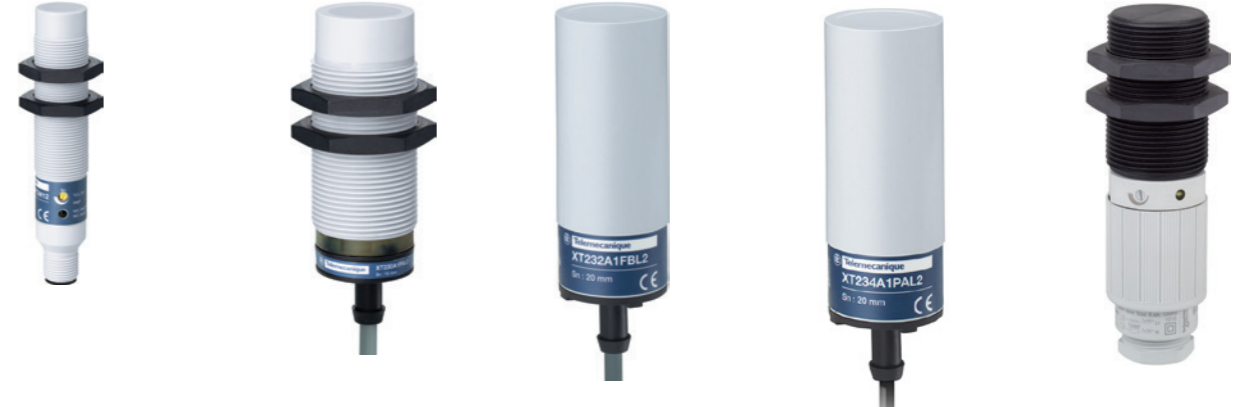

| | | | | |
|------------------|------------------|------------------|------------------|-------------------|
| M18 x 1 | M30 x 1.5 | Plain: Ø 32 | Plain: Ø 34 | M30 x 1.5 |
| Plastic | | | | |
| - | | | | |
| 8 | 15 | 20 | 20 | 15 |
| IP 67 IP 65 | | | | IP 65 |
| • | • | - | • | • |
| • | • | • | - | • |
| • | • | • | • | - |
| • | - | - | - | - |
| - | - | - | - | • |
| XT218A1 • | XT230A1 • | XT232A1 • | XT234A1 • | XT230A2MDB |
| 12 | | | | |

Presentation

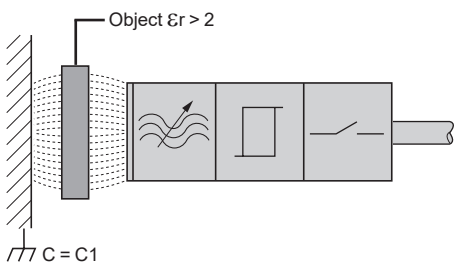
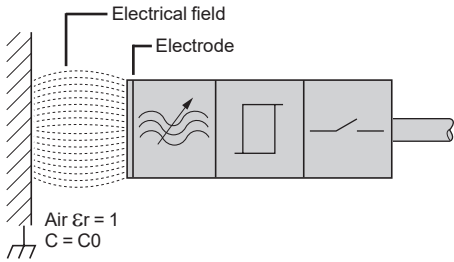

Types of sensor

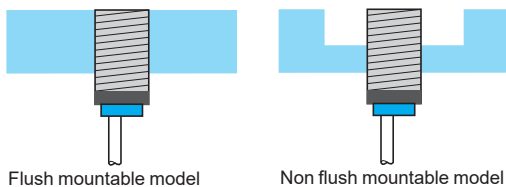
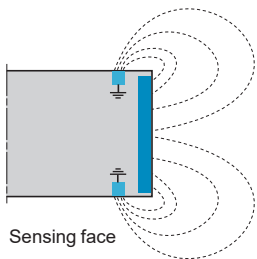
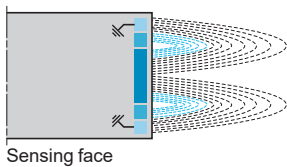

Advantages

- No physical contact with the object to be detected.
- Solid-state product, no moving parts (service life not related to number of operating cycles).
- Detection of any object irrespective of material or conductivity, for example: metals, minerals, wood, plastic, glass, cardboard, leather, ceramic, fluids, etc.

Operating principle

An electrical field is created between 2 electrodes on the front face of the sensor. These electrodes constitute a capacitor with a capacitance of:

$$C = \epsilon_0 * \epsilon_r * A/d \text{ where:}$$

$\epsilon_0 = 8.854\ 187 \text{ pF/m}$ (permittivity in free space)

ϵ_r : relative permittivity of the material present between the 2 electrodes

A: dimensions of electrodes

d: distance between electrodes

All materials where $\epsilon_r > 2$ will be detected.

When an object of any material ($\epsilon_r > 2$) passes the sensing face of the sensor, it modifies the coupling capacitance (C_1).

This variation in capacitance ($C_1 > C_0$) instigates the starting of the oscillator which, in turn, causes the output driver to operate and provides an output signal.

Sensors flush mountable in support

The special feature of these versions is the shape of the electrical field which is rectilinear and confined within the dimensions of the product.

Cylindrical and block type models used for the detection of insulated materials (wood, plastic, cardboard, glass...), conductive materials (metal...) or liquid through an insulated partition (glass, plastic...) with a maximum thickness of 4 mm.

These products are recommended for:

- comparatively short detection distances,
- applications requiring flush mounting of the sensor,
- detection through a partition (example: detection of glass through cardboard),
- side by side mounting.

Sensors non flush mountable in support

Cylindrical models (plastic case).

The spherical shape of the electrical field enables detection of any type of material whether it be solid, liquid, granular... (metal, water, oil, plastic pellets, powder, flour...).

Detection can be achieved through a partition or by direct contact (immersion) of the active surface with the object to be detected.

Distances to be adhered to around the sensing face. (See characteristics page 17).

Mounting precautions

Non flush mountable models cannot be flush mounted in their support.

The non flush mountable models require a free zone around the active head. (See page 17).

Terminology

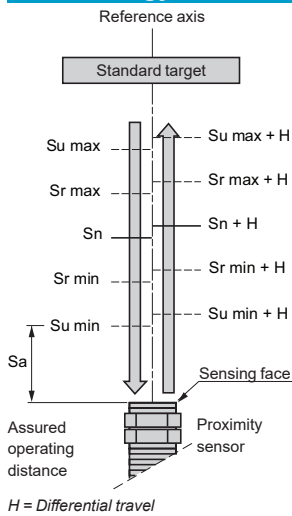

Definitions

In order to ensure that customers can make reliable product comparisons and selection, the standard IEC 60947-5-2 defines various sensing distances, such as:

Nominal sensing distance (S_n)

The rated operating distance for which the sensor is designed. It does not take into account any variations (manufacturing tolerances, temperature, voltage).

Effective sensing distance (S_r)

The effective sensing distance is measured at the rated voltage (U_n) and the rated ambient temperature ($23\text{ °C} \pm 5\text{ °C}$)

It must be between 90% and 110% of S_n .

Usable sensing distance (S_u)

The usable sensing distance is measured at the limits of the permissible variations in the ambient temperature and at a supply voltage equal to 85% and 110% of the rated voltage.

It must be between 80% and 120% of S_r .

Assured operating distance (S_a)

This is the operating zone of the sensor.

The assured operating distance is between 0 and 72% of S_n .

Standard metal target

The standard IEC 60947-5-2 defines the standard metal target as a square mild steel (Fe 360) plate, 1 mm thick.

The side dimension of the plate is either equal to the diameter of the circle engraved on the sensing face of the sensor or 3 times the nominal sensing distance (S_n).

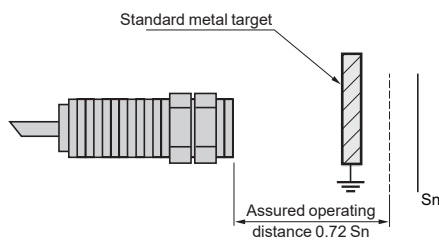

Repeat accuracy

The repeat accuracy (R) is the repeatability of the sensing distance between successive operations. Readings are taken over a period of time whilst the sensor is subjected to voltage and temperature variations: 8 hours, 10 to 30 °C, $U_n \pm 5\%$.

It is expressed as a percentage of the effective sensing distance S_r .

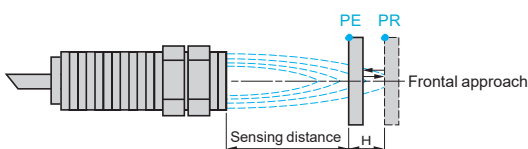

PE = pick-up point, the target is detected

PR = drop-out point, the target is no longer detected

Differential travel

The differential travel (H) or hysteresis, is the distance between the operating point, as the standard metal target moves towards the sensor, and the release point, as it moves away.

This hysteresis is essential for the stable operation of the sensor.

Terminology (continued)

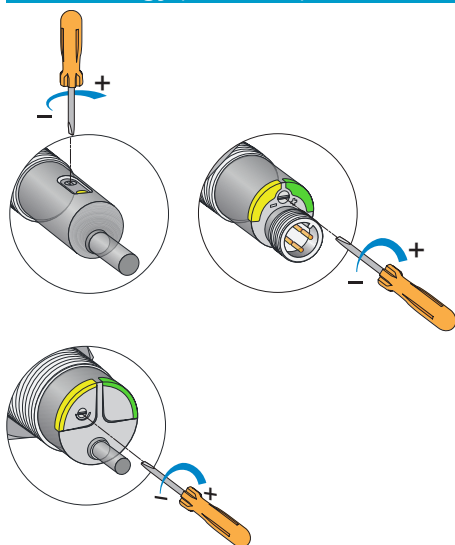

Sensitivity of the sensor

All our sensors incorporate a sensitivity adjustment potentiometer. This enables the sensitivity of the sensor to be adjusted to suit the type of object to be detected.

Depending on the sensor version, the sensitivity adjustment potentiometer is either mounted on the side or the rear.

The sensors are factory preset for nominal sensitivity.

Depending on the application, adjustment of the sensitivity could be necessary as follows:

- increasing the sensitivity for objects which have a weak influence (weaker): paper, cardboard, glass, plastic,
- decreasing the sensitivity for objects which have a strong influence (stronger): metals, liquids.

However, in the event of severe variations in the ambient conditions, do not increase the sensitivity of the sensor such that it is set to its maximum operating limits.

An increase in sensitivity causes an increase in the switching hysteresis.

Operating distances

The operating distance of the sensor is related to the dielectric constant (ϵ_r) of the object material to be detected.

The higher the value of ϵ_r , the easier the detection of the object will be.

The assured operating distance depends on the object material: $S_a = S_n \times F_c$

S_a = assured operating distance,

S_n = nominal sensing distance of the sensor,

F_c = correction factor related to the object material.

Example: sensor **XT530B1PAL2** used to detect a rubber object.

$S_n = 10 \text{ mm}$, $F_c = 0.3$.

Assured operating distance $S_a = 10 \times 0.3 \text{ mm}$.

The list below indicates the dielectric constant values of the most common object materials, together with their correction factors (F_c) for the nominal sensing distance of the sensor.

| Material | ϵ_r | F_c | Material | ϵ_r | F_c |
|-----------------|--------------|-------------|-----------------|--------------|-----------|
| Air | 1 | 0 | Petrol | 2.2 | 0.2 |
| Acetone | 20 | 0.8 | Plexiglass | 3.2 | 0.3 |
| Alcohol | 24 | 0.85 | Polyester resin | 2.8...8 | 0.2...0.6 |
| Ammonia | 15...25 | 0.75...0.85 | Polystyrene | 3 | 0.3 |
| Cement (powder) | 4 | 0.35 | Porcelain | 5...7 | 0.4...0.5 |
| Cereals | 3...5 | 0.3...0.4 | Powdered milk | 3.5...4 | 0.3...0.4 |
| Epoxy resin | 4 | 0.36 | Rubber | 2.5...3 | 0.3 |
| Ethylene glycol | 38 | 0.95 | Sand | 3...5 | 0.3...0.4 |
| Flour | 2.5...3 | 0.2...0.3 | Salt | 6 | 0.5 |
| Glass | 3...10 | 0.3...0.7 | Sugar | 3 | 0.3 |
| Marble | 6...7 | 0.5...0.6 | Teflon | 2 | 0.2 |
| Mica | 6...7 | 0.5...0.6 | Vaseline | 2...3 | 0.2...0.3 |
| Nylon | 4...5 | 0.3...0.4 | Water | 80 | 1 |
| Oil | 2.2 | 0.2 | Wood (damp) | 10...30 | 0.7...0.9 |
| Paper | 2...4 | 0.2...0.3 | Wood (dry) | 2...7 | 0.2...0.6 |
| Paraffin | 2...2.5 | 0.2 | | | |

Environment

■ Electromagnetic interference

The sensors undergo electromagnetic interference testing in accordance with the recommendations of standard IEC 60947-5-2 (electrostatic discharges, radiated electromagnetic fields, fast transients, impulse voltages).

■ Thermal influences

It is advisable to remain within the values stated on the characteristic pages so as to avoid sensing distance drift and possible incorrect operation of the sensor.

■ Chemical agents

To ensure a long service life, it is essential that any chemicals coming into contact with the case of the sensor are non corrosive.

■ Earthing

Earthing of an object that has high conductivity increases the sensing distance.

Additional information relating to outputs

Refer to corresponding pages relating to inductive proximity sensors for:

- Terminology.
- Details and specific aspects of 2-wire and 3-wire type connection.
- Connecting several sensors in series or parallel.

Application examples:

Bottle filling

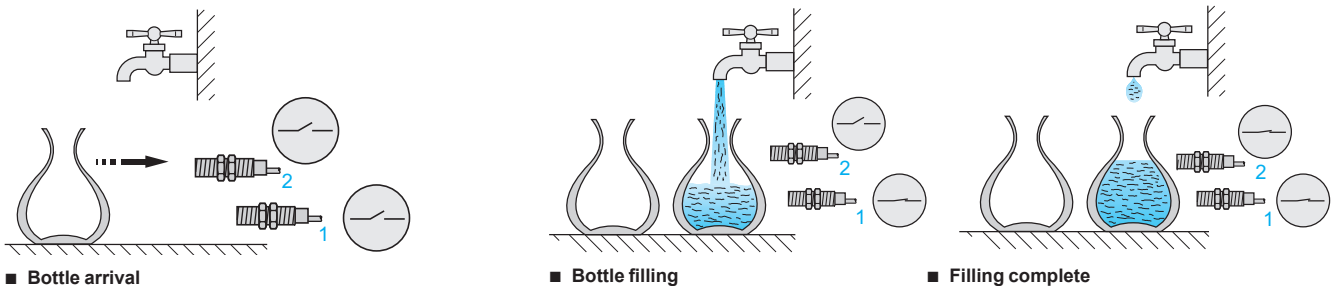

■ Bottle arrival

- Bottles are fed on a conveyor for filling. Sensors 1 and 2 are in an unoperated state.
- Adjustment:
 - sensor 1 is adjusted to detect the bottle,
 - sensor 2 is adjusted to detect the water in the bottle.

■ Bottle filling

As soon as the bottle enters the detection zone of sensor 1, the filling operation commences. Sensor 2 remains in the unoperated state.

■ Filling complete

Sensor 2 detects that the required level has been reached and stops further filling.

Reminder: the wall of the container must be non metallic and its thickness ≤ 4 mm

Livestock feeder filling

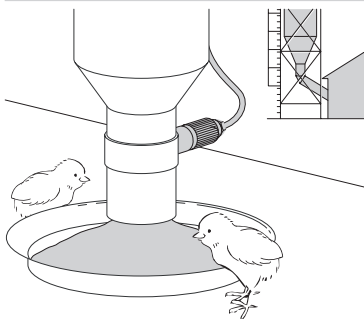

Capacitive technology is particularly suited for the detection of feed levels in automatic dispensers for livestock. Any type of feed can be detected (pellets, powders, broths, grains, pastas, etc.).

The materials used, as well as the degree of protection of the sensor, have been specially selected to tolerate the acidic and dusty environments associated with this application.

Capacitive proximity sensors

XT range

Cylindrical, flush mountable. Metal case

AC or DC supply



XT512B1P●M12



XT512B1P●L2



XT518B1P●M12



XT518B1P●L2



XT518B1F●L2



XT530B1P●M12



XT530B1●●L2



XT132B1F●L2

Ø 12, threaded M12 x 1, nickel copper alloy

| Sensing distance (Sn) | Function | Output | Connection | Reference | Weight |
|--|----------|--------|----------------------|---------------------|--------|
| mm | | | | | kg |
| 3-wire $\overline{\text{---}}$ 12...24 V | | | | | |
| 2 | NO | PNP | Pre-cabled (L = 2 m) | XT512B1PAL2 | 0.070 |
| | | | M12 connector | XT512B1PAM12 | 0.040 |
| | NC | PNP | Pre-cabled (L = 2 m) | XT512B1PBL2 | 0.070 |
| | | | M12 connector | XT512B1PBM12 | 0.040 |

Ø 18, threaded M18 x 1, nickel copper alloy

| Sensing distance (Sn) | Function | Output | Connection | Reference | Weight |
|--|----------|--------|----------------------|---------------------|--------|
| mm | | | | | kg |
| 4-wire $\overline{\text{---}}$ 12...24 V | | | | | |
| 5 | NO/NC | PNP | Pre-cabled (L = 2 m) | XT518B1PCL2 | 0.150 |
| | | | M12 connector | XT518B1PCM12 | 0.075 |
| 3-wire $\overline{\text{---}}$ 12...24 V | | | | | |
| 5 | NO | PNP | Pre-cabled (L = 2 m) | XT518B1PAL2 | 0.150 |
| 2-wire \sim 24-240 V | | | | | |
| 5 | NO | – | Pre-cabled (L = 2 m) | XT518B1FAL2 | 0.150 |
| | NC | – | Pre-cabled (L = 2 m) | XT518B1FBL2 | 0.150 |

Ø 30, threaded M30 x 1.5, nickel copper alloy

| Sensing distance (Sn) | Function | Output | Connection | Reference | Weight |
|--|----------|--------|----------------------|---------------------|--------|
| mm | | | | | kg |
| 4-wire $\overline{\text{---}}$ 12...24 V | | | | | |
| 10 | NO/NC | PNP | Pre-cabled (L = 2 m) | XT530B1PCL2 | 0.270 |
| | | | M12 connector | XT530B1PCM12 | 0.150 |
| 3-wire $\overline{\text{---}}$ 12...24 V | | | | | |
| 10 | NO | PNP | Pre-cabled (L = 2 m) | XT530B1PAL2 | 0.270 |
| 2-wire \sim 24-240 V | | | | | |
| 10 | NO | – | Pre-cabled (L = 2 m) | XT530B1FAL2 | 0.270 |
| | NC | – | Pre-cabled (L = 2 m) | XT530B1FBL2 | 0.270 |

Ø 32, plain, nickel copper alloy

| Sensing distance (Sn) | Function | Output | Connection | Reference | Weight |
|--|----------|--------|----------------------|---------------------------|--------|
| mm | | | | | kg |
| 2-wire \sim 24-240 V | | | | | |
| 15 | NO | | Pre-cabled (L = 2 m) | XT132B1FAL2 (1) | 0.400 |

(1) Mounting accessory included with sensor.

Accessories

Fixing and protection accessories, fuses and fuse terminal block: see page 12.

Capacitive proximity sensors

XT range

Cylindrical, flush mountable. Metal case

AC or DC supply

| Characteristics | | | | | | | | |
|---|---|--|--|--------------------------|--|-------------------------|-------------------------|------------------------|
| Sensor type | | M12 XT512● | M18 XT518● | M30 XT530● | Ø 32 XT132● | | | |
| | | 3-wire ⋯ | 3-wire ⋯ 4-wire ⋯ | 2-wire ~ | 3-wire ⋯ 4-wire ⋯ | 2-wire ~ 2-wire ~ | | |
| Product certifications | | CE, cULus, UKCA | | CE, cULus, UKCA, CCC (1) | CE, cULus, UKCA, CCC (1) | CE, cULus, UKCA | | |
| Conformity to standards | | EN/IEC 60947-5-2, UL 508, CSA C22.2 n°14 | | | | | | |
| Connection | Pre-cabled, length 2 m | ● | ● | ● | ● | ● | | |
| | Connector, M12 | ● | ● | – | ● | – | | |
| Main characteristics | | | | | | | | |
| Nominal sensing distance (Sn) | Conforming to IEC 60947-5-2 | mm | 2 | 5 | 10 | 15 | | |
| Assured operating distance Sa | Conforming to IEC 60947-5-2 | mm | 0...1.6 | 0...3.60 | 0...3.60 | 0...7.2 | 0...7.2 | 0...11 |
| Adjustment zone | | mm | 0.5...5 | 2...7.5 | 2...7.5 | 3...15 | 3...15 | 3...17 |
| Repeat accuracy | | Sr | < 5 % | | | | | |
| Differential travel | | Sr | < 3...20 % | | | | | |
| Output characteristics | | | | | | | | |
| Output state indication | | Yellow LED | | | | | | |
| Switching capacity | | mA | 200 | 200 | 300 | 200 | 300 | 300 |
| Maximum switching frequency | | Hz | 40 | 40 | 10 | 25 | 10 | 10 |
| Protection against short-circuits | | | ● | ● | – (2) | ● | – (2) | – (2) |
| Voltage drop | | V | ≤ 2.5 | ≤ 2.5 | ≤ 10 | ≤ 2.5 | ≤ 10 | ≤ 10 |
| Residual current, open state | | mA | < 0.1 | < 0.1 | < 5 | < 0.1 | < 5 | < 5 |
| Delays | First-up | ms | ≤ 300 | ≤ 300 | ≤ 200 | ≤ 300 | ≤ 200 | ≤ 200 |
| | Response | ms | ≤ 15 | ≤ 15 | ≤ 30 | ≤ 15 | ≤ 30 | ≤ 30 |
| | Recovery | ms | ≤ 15 | ≤ 15 | ≤ 30 | ≤ 15 | ≤ 30 | ≤ 30 |
| Supply | | | | | | | | |
| Rated supply voltage | | V | ⋯ 12...24 | ⋯ 12...24 | ~ 24 - 240 50/60 Hz | ⋯ 12...24 | ~ 24 - 240 50/60 Hz | ~ 24 - 240 50/60 Hz |
| Voltage limits (including ripple) | | V | ⋯ 10...30 | ⋯ 10...30 | ~ 20 - 264 50/60 Hz | ⋯ 10...30 | ~ 20 - 264 50/60 Hz | ~ 20 - 264 50/60 Hz |
| Current consumption, no-load | | mA | < 15 | < 15 | < 3 (3) | < 15 | < 3 (3) | < 4 |
| Protection against reverse polarity | | | Yes | Yes | – | Yes | – | – |
| Environment | | | | | | | | |
| Materials | Case | Nickel copper alloy | | | | | | |
| | Cable | PVC | | | | | | |
| | Number and c.s.a. of wires | 3 x 0.34 mm ² | 3 x 0.34 mm ² or 4 x 0.34 mm ² | 2 x 0.5 mm ² | 3 x 0.34 mm ² or 4 x 0.34 mm ² | 2 x 0.5 mm ² | 2 x 0.5 mm ² | |
| Degree of protection | Conforming to IEC 60529 and IEC 60947-5-2 | | IP 67 IP 65 | | | | IP 67 IP 65 | |
| Storage and operating temperature | | °C | - 25...+ 70 | | | | | |
| Vibration resistance | Conforming to IEC 60068-2-6 | | 10 gn, ± 1 mm (f = 10...55 Hz) | | | | | |
| Shock resistance | Conforming to IEC 60068-2-27 | | 30 gn, 11 ms | | | | | 30 gn, 6 ms |
| Resistance to electromagnetic interference | | | | | | | | |
| Electrostatic discharges | Conforming to IEC 61000-4-2 | kV | 8 (air) / 4 (contact) | | | | | |
| Radiated electromagnetic fields | Conforming to IEC 61000-4-3 | V/m | 10 | | | | | |
| Fast transients | Conforming to IEC 61000-4-4 | kV | 2 | | | | | |

(1) CCC: pending.

(2) These sensors do not incorporate overload or short-circuit protection and therefore, it is essential to connect a "quick-blow" fuse in series with the load (see page 12).

(3) At ~ 240 V.

Capacitive proximity sensors

XT range

Cylindrical, flush mountable. Metal case

AC or DC supply

Dimensions

M12, pre-cabled, ∩

XT512B1PAL2, XT512B1PBL2

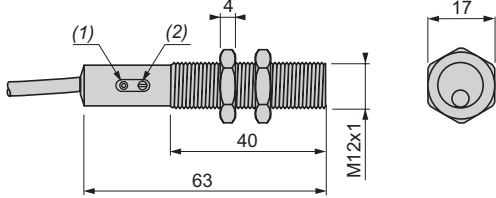

M12, M12 connector, ∩

XT512B1PAM12, XT512B1PBM12

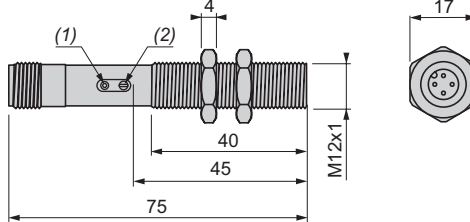

M18, pre-cabled, ∩

XT518B1PCL2, XT518B1PAL2

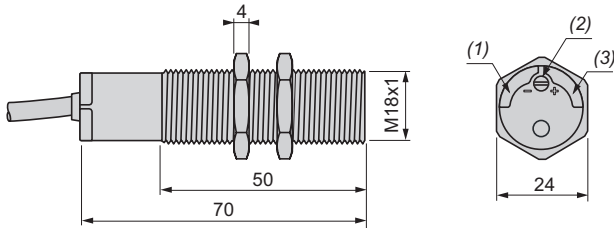

M18, M12 connector, ∩

XT518B1PCM12

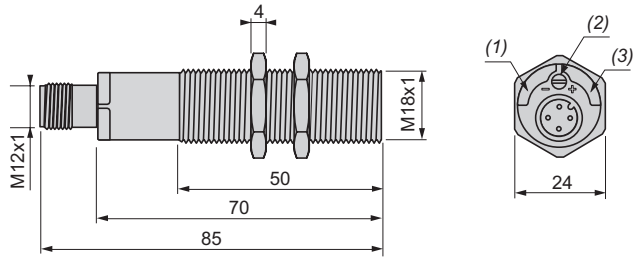

M18, pre-cabled, ~

XT518B1FAL2, XT518B1FBL2

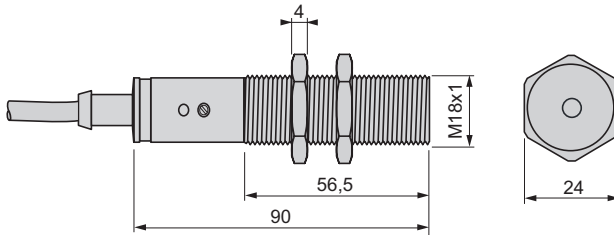

M30, câble, ∩

XT530B1PCL2, XT530B1PAL2

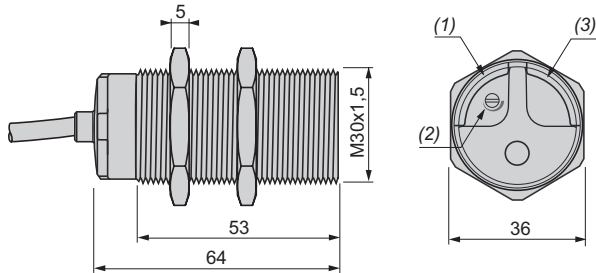

M30, pre-cabled, ~

XT530B1FAL2, XT530B1FBL2

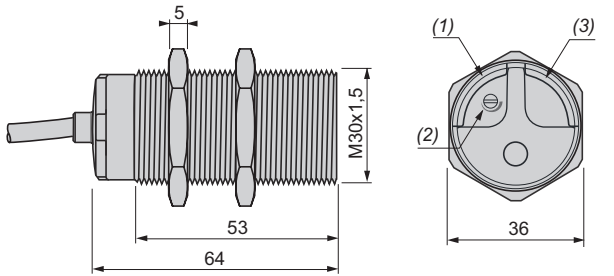

M12 connector

XT530B1PCM12

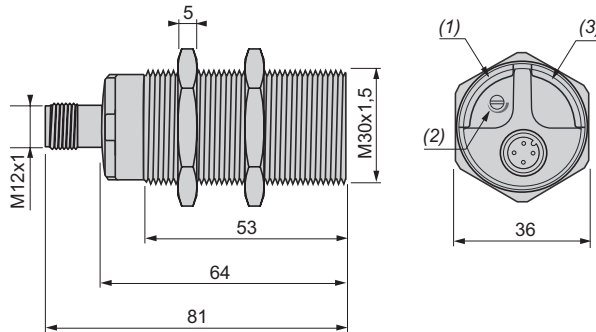

∅ 32, plain, pre-cabled, ~

XT132B1FAL2

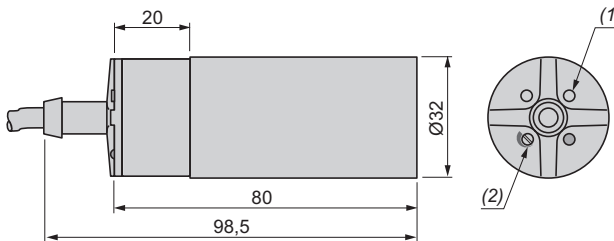

Mounting accessory (included with sensor XT132B1FAL2)

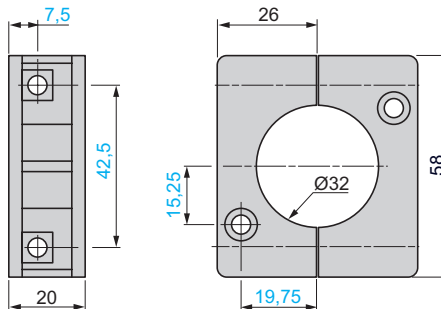

- (1) Output status LED (yellow).
- (2) Adjustment potentiometer (sensitivity).
- (3) Power ON LED (green).

Capacitive proximity sensors

XT range

Cylindrical, flush mountable. Metal case

AC or DC supply

Wiring schemes

Connector version

M12 connector



4-wire ~, PNP
NO + NC output, M12

XT518B1PCM12
XT530B1PCM12

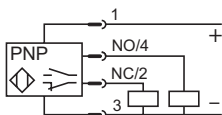

3-wire ~, PNP
NO output, M12

XT512B1PAM12

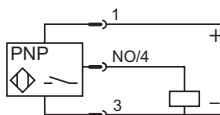

3-wire ~, PNP
NC output, M12

XT512B1PBM12

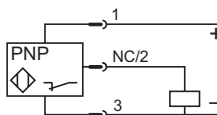

Pre-cabled version

Wire color

BU: Blue
BN: Brown
BK: Black
WH: White
YE/GN: Yellow/green

4-wire ~, PNP
NO + NC output,
pre-cabled

XT518B1PCL2
XT530B1PCL2

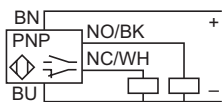

3-wire ~, PNP
NO output, pre-cabled

XT512B1PAL2
XT518B1PAL2
XT530B1PAL2

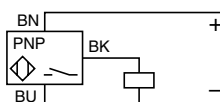

3-wire ~, PNP
NC output, pre-cabled

XT512B1PBL2

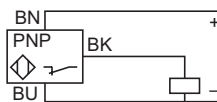

2-wire ~
NO output

XT518B1FAL2
XT530B1FAL2
XT132B1FAL2

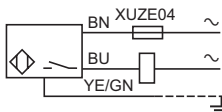

2-wire ~
NC output

XT518B1FBL2
XT530B1FBL2

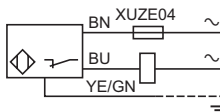

Adjustment

Sensitivity adjustment

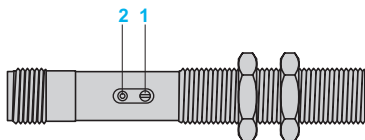

Adjustment from the side for

XT512●●●●M12
XT512●●●●L2
XT518B1F●L2

Adjustment from the rear for

XT1●●●●●L2
XT518●●●●M12
XT518B1P●L2
XT530●●●●M12

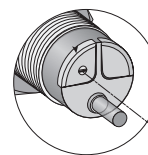
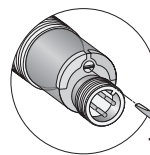
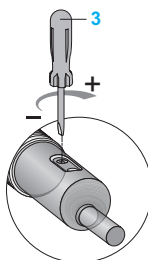

1 Adjustment potentiometer

2 LED

3 Adjustment using suitable screwdriver (included with sensor)

Setting-up

Minimum mounting distances (mm)

Side by side

Face to face

Facing a metal object

Mounted in support

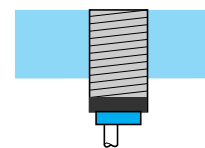
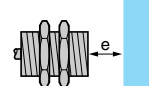
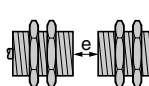
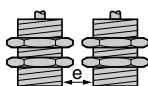

XT512, M12 flush mountable

$e \geq 12$

$e \geq 6 \times S_n$

$e \geq 3 \times S_n$

–

XT518, M18 flush mountable

$e \geq 18$

$e \geq 6 \times S_n$

$e \geq 3 \times S_n$

–

XT530, M30 flush mountable

$e \geq 30$

$e \geq 6 \times S_n$

$e \geq 3 \times S_n$

–

XT132, Ø 32 plain, flush mountable

$e \geq 35$

$e \geq 6 \times S_n$

$e \geq 3 \times S_n$

–

Fixing nut tightening torque: XT512: 6 N.m (53 lb-in), XT518: 15 N.m (133 lb-in), XT530: 40 N.m (354 lb-in).

Capacitive proximity sensors

XT range

Cylindrical, non flush mountable. Plastic case

AC or DC supply



XT218A1PCM12



XT230A1●●L2



XT230A2MDB



XT232A1F●L2



XT234A1PAL2

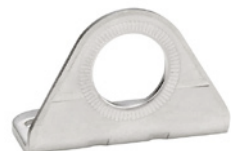

XUZA118

Ø 18, threaded M18 x 1

| Sensing distance (Sn) (mm) | Function | Output | Connection | Reference | Weight kg |
|----------------------------|----------|--------|----------------------|--------------|-----------|
| 4-wire ~ 12...24 V | | | | | |
| 8 | NO/NC | PNP | M12 connector | XT218A1PCM12 | 0.060 |
| 3-wire ~ 12...24 V | | | | | |
| 8 | NO | PNP | Pre-cabled (L = 2 m) | XT218A1PAL2 | 0.140 |
| | | NPN | Pre-cabled (L = 2 m) | XT218A1NAL2 | 0.140 |
| 2-wire ~ 24-240 V | | | | | |
| 8 | NO | – | Pre-cabled (L = 2 m) | XT218A1FAL2 | 0.140 |

Ø 30, threaded M30 x 1.5

| Sensing distance (Sn) (mm) | Function | Output | Connection | Reference | Weight kg |
|----------------------------|----------|--------|----------------------|--------------|-----------|
| 4-wire ~ 12...24 V | | | | | |
| 15 | NO/NC | PNP | M12 connector | XT230A1PCM12 | 0.100 |
| 3-wire ~ 12...24 V | | | | | |
| 15 | NO | PNP | Pre-cabled (L = 2 m) | XT230A1PAL2 | 0.200 |
| | | NPN | Pre-cabled (L = 2 m) | XT230A1NAL2 | 0.200 |
| 2-wire ~ 24-240 V | | | | | |
| 15 | NO | – | Pre-cabled (L = 2 m) | XT230A1FAL2 | 0.200 |
| | NC | – | Pre-cabled (L = 2 m) | XT230A1FBL2 | 0.200 |

Ø 30, threaded M30 x 1.5, Application series

| Sensing distance (Sn) (mm) | Function | Connection | Reference | Weight kg |
|-----------------------------------|----------------------|-----------------|------------|-----------|
| 2-wire ~ 24-240 V / ~ 24 V | | | | |
| 0...15, adjustable | NO or NC, selectable | Screw terminals | XT230A2MDB | 0.100 |

Applications: sensor **XT230A2MDB** is particularly suited to automatic feed systems for livestock. It enables detection of the level of all types of feed: pellets, grains, pastas, broths and powders.

Ø 32, plain (1)

| Sensing distance (Sn) (mm) | Function | Connection | Reference | Weight kg |
|----------------------------|----------|----------------------|-------------|-----------|
| 2-wire ~ 24-240 V | | | | |
| 20 | NO | Pre-cabled (L = 2 m) | XT232A1FAL2 | 0.350 |
| | NC | Pre-cabled (L = 2 m) | XT232A1FBL2 | 0.350 |

Ø 34, plain (1)

| Sensing distance (Sn) (mm) | Function | Connection | Reference | Weight kg | |
|----------------------------|----------|------------|----------------------|-------------|-------|
| 3-wire ~ 12-24 V | | | | | |
| 20 | NO | PNP | Pre-cabled (L = 2 m) | XT234A1PAL2 | 0.350 |

Accessories for capacitive sensors XT1●, XT2● and XT5●

Fixing accessories

| Description | For use with sensor | Reference | Weight kg |
|--------------------|---------------------|-----------|-----------|
| 90° fixing bracket | Ø 12 | XXZ12 | 0.025 |
| | Ø 18 | XUZA118 | 0.045 |
| | Ø 30 | XXZ30 | 0.115 |

Protection accessories

| Description | For use with sensor | Reference | Weight kg |
|-----------------|--------------------------|-----------|-----------|
| Threaded sleeve | Ø 30, threaded M30 x 1.5 | XTAZ30 | 0.035 |

Fuses (for unprotected 2-wire ~ sensors)

| Description | Type | Sold in lots of | Unit reference | Weight kg |
|------------------------|---------------------|-----------------|----------------|-----------|
| Cartridge fuses 5 x 20 | 0.4 A "quick-blow" | 10 | XUZE04 | 0.001 |
| | 0.63 A "quick-blow" | 10 | XUZE06 | 0.001 |
| | 0.8 A "quick-blow" | 10 | XUZE08 | 0.001 |

Fuse terminal block (Schneider Electric product)

| Description | Sold in lots of | Unit reference | Weight kg |
|---|-----------------|----------------|-----------|
| Fuse terminal block for 5 x 20 fuses, black | 50 | NSYTRV42SF5 | 0.018 |

(1) Mounting accessory included with sensor.

Capacitive proximity sensors

XT range

Cylindrical, non flush mountable. Plastic case

AC or DC supply

| Characteristics | | | | | | | | | | | | |
|---|----------------------------------|--|-----------------------|-------------|--------------------------|------------------------|-------------|--------------------------|------------------------------------|-----------------|------------------------|-------------|
| Sensor type | | M18 | | | M30 | | | Ø 32 | Ø 34 | | | |
| | | XT218A1 | | | XT230A1 | | | XT230A2 | XT232A | XT234A | | |
| | | 4-wire --- | 3-wire --- | 2-wire ~ | 4-wire --- | 3-wire --- | 2-wire ~ | 2-wire ~ | 2-wire ~ | 3-wire --- | | |
| Product certifications | | CE, cULus, UKCA | | | CE, cULus, UKCA, CCC (1) | | | CE, cULus, UKCA, CCC (1) | | CE, cULus, UKCA | | |
| Conformity to standards | | EN/IEC 60947-5-2, UL 508, CSA C22.2 n°14 | | | | | | | | | | |
| Connection | Pre-cabled, length 2 m | - | • | • | - | • | • | - | • | • | | |
| | Connector, M12 | • | - | - | • | - | • | - | - | - | | |
| | Screw terminals, 2 x M3 | - | - | - | - | - | - | • | - | - | | |
| Main characteristics | | | | | | | | | | | | |
| Nominal sensing distance (Sn) | IEC 60947-5-2 | mm | 8 | | | 15 | | | 15 | 20 | 20 | |
| Assured operating distance (Sa) | IEC 60947-5-2 | mm | 0...5.8 | | | 0...11 | | | 0...11 | 0...15 | 0...15 | |
| Adjustment zone | | mm | 0...12 | | | 0...17 | | | 0...17 | 0...22 | 0...22 | |
| Repeat accuracy | | Sr | < 5% | | | | | | | | | |
| Differential travel | | Sr | < 1...20% | | | | | < 1...15% | | < 1...20% | | |
| Output characteristics | | | | | | | | | | | | |
| Output state indication | | Yellow LED | | | | | | | | | | |
| Switching capacity | | mA | 2 x 200 | 200 | 300 | 2 x 200 | 200 | 300 | 300 | 300 | 200 | |
| Maximum switching frequency | | Hz | 30 | 30 | 15 | 50 | 50 | 15 | 40 | 15 | 15 | |
| Protection against short-circuits | | | • | • | -(2) | • | • | -(2) | -(2) | -(2) | • | |
| Voltage drop | | V | < 2.5 | < 2.5 | < 10 | < 2.5 | < 2.5 | < 10 | < 2 | < 10 | < 2.5 | |
| Residual current, open state | | µA | ≤ 100 | ≤ 100 | - | ≤ 100 | ≤ 100 | - | < 120 | - | ≤ 100 | |
| Delays | First-up | ms | < 100 | < 100 | < 200 | < 100 | < 100 | < 200 | < 100 | < 200 | < 100 | |
| | Response | ms | < 15 | < 15 | < 30 | < 15 | < 10 | < 30 | < 10 | < 30 | < 15 | |
| | Recovery | ms | < 15 | < 15 | < 30 | < 15 | < 10 | < 30 | < 10 | < 30 | < 15 | |
| Supply | | | | | | | | | | | | |
| Rated supply voltage | | V | --- 12...24 | | | ~ 24...240 50/60 Hz | | | --- 12...24 | | ~ 24...240 50/60 Hz | |
| Voltage limits (including ripple) | | V | --- 10...30 | | | ~ 20...265 | | | --- 10...30 | | ~ 20...265 | |
| Current consumption, no-load | 24 V | mA | < 25 | < 15 | - | < 25 | < 15 | - | - | - | < 25 | |
| | 240 V | mA | - | - | < 4 | - | - | < 4 | < 3 | < 4 | - | |
| Protection against reverse polarity | | | Yes | Yes | - | Yes | Yes | - | - | - | Yes | |
| Environment | | | | | | | | | | | | |
| Materials | Case | Plastic | | | | | | | | | | |
| | Cable | PVC | | | | | | | | | | |
| | Number and c.s.a. of wires (mm²) | - | 3 x 0.34 | 2 x 0.5 | - | 3 x 0.34 | 2 x 0.5 | - | 2 x 1 (min.) (3) 2 x 2.5 (max.) | 2 x 0.5 | 3 x 0.34 | |
| Degree of protection | Conforming to IEC 60529 | IP 67 | | | | | | IP 65 | | IP 67 | IP 67 | |
| Storage temperature | | °C | - 10...+ 60 | | | | | | - 40...+ 85 | | - 10...+ 60 | - 10...+ 60 |
| Operating temperature | | °C | - 10...+ 60 | | | | | | - 20...+ 70 | | - 10...+ 60 | - 10...+ 60 |
| Vibration resistance | IEC 60068-2-6 | 10 gn, ± 1 mm (f = 10...55 Hz) | | | | | | | | | | |
| Shock resistance | IEC 60068-2-27 | 30 gn, 11 ms | | | | | | | | | | |
| Resistance to electromagnetic interference | | | | | | | | | | | | |
| Electrostatic discharges | IEC 61000-4-2 | kV | 8 (air) / 4 (contact) | | | | | | | | | |
| Radiated electromagnetic fields | IEC 61000-4-3 | V/m | 3 | | | | | | | | | |
| Fast transients | IEC 61000-4-4 | kV | 2 | | | | | | | | | |

(1) CCC: pending.

(2) These sensors do not incorporate overload or short-circuit protection and therefore, it is essential to connect a "quick-blow" fuse in series with the load (see page 12).

(3) The supply cable can have a 14 mm maximum diameter sheath.

Application example (XT230A2MDB)

Automatic feed system for livestock

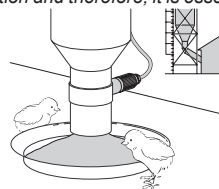

Capacitive proximity sensors

XT range

Cylindrical, non flush mountable. Plastic case

AC or DC supply

Dimensions

M18, pre-cabled

XT218A1●●L2

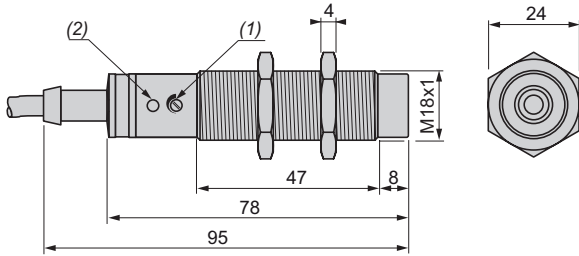

(1) Adjustment potentiometer.
(2) LED.

M18, M12 connector

XT218A1PCM12

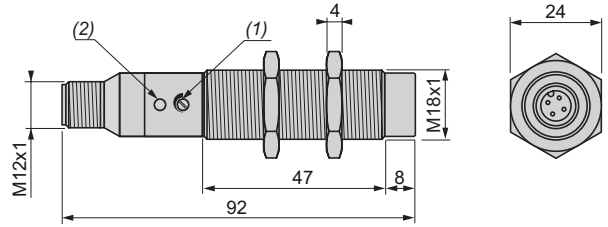

(1) Adjustment potentiometer.
(2) LED.

M30, pre-cabled

XT230A1●●L2

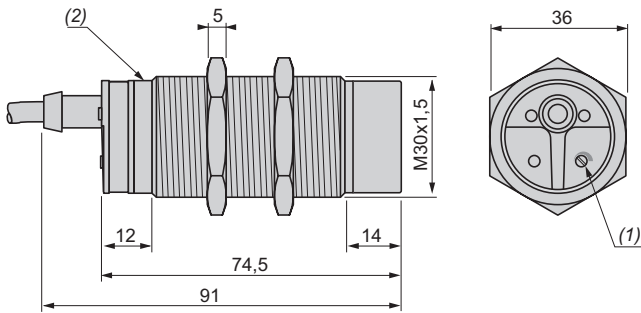

(1) Adjustment potentiometer.
(2) LED.

M30, M12 connector

XT230A1PCM12

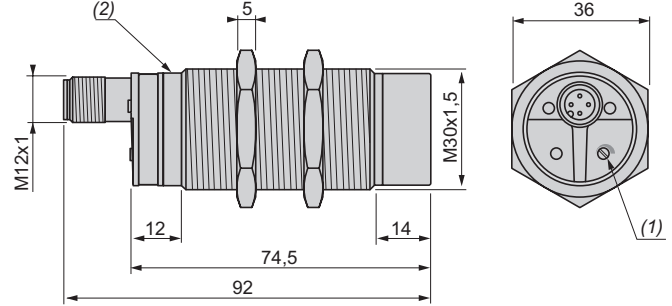

(1) Adjustment potentiometer.
(2) LED.

Capacitive proximity sensors

XT range

Cylindrical, non flush mountable. Plastic case

AC or DC supply

Dimensions (continued)

M30, screw terminals

XT230A2MDB

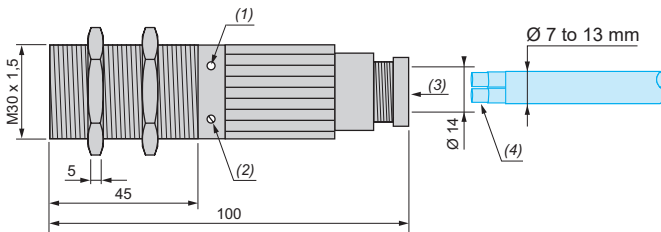

(1) LED.

(2) Potentiometer.

(3) Entry incorporating cable gland.

(4) 2 x 1 mm² to 2.5 mm² wires max.

$\varnothing 32$, plain, pre-cabled

XT232A1FAL2, XT232A1FBL2

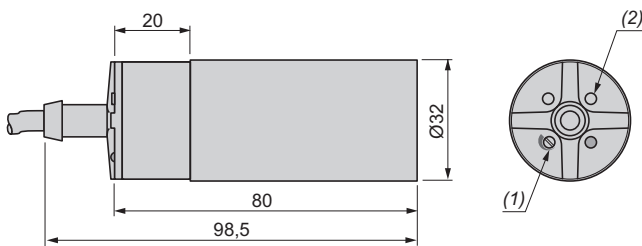

(1) Adjustment potentiometer.

(2) LED.

$\varnothing 34$, plain, pre-cabled

XT234A1PAL2

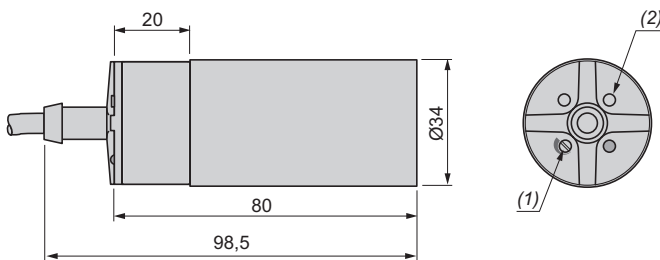

(1) Adjustment potentiometer.

(2) LED.

Capacitive proximity sensors

XT range

Cylindrical, non flush mountable. Plastic case

AC or DC supply

Dimensions (continued)

Accessories

Mounting accessory (included with sensor XT232A1F●L2)

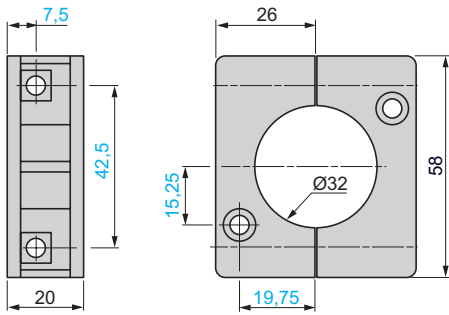

Mounting accessory (included with sensor XT234A1PAL2)

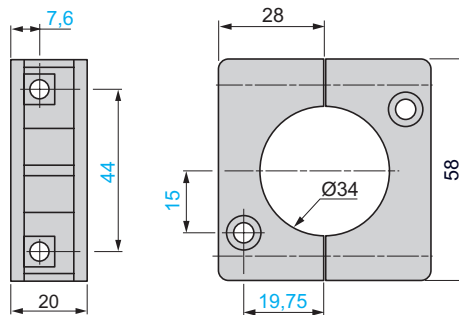

XUZA118

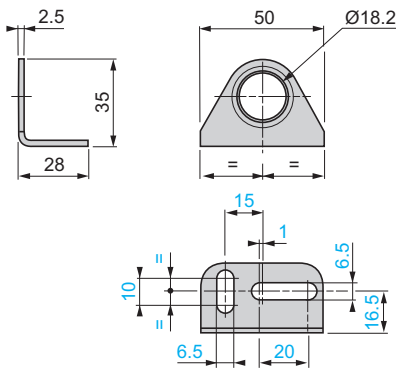

XXZ12, XXZ30

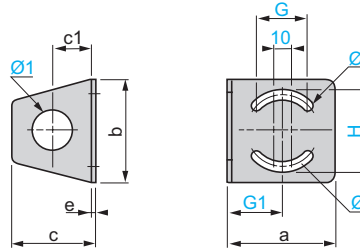

| XXZ | a | b | c | c1 | e | H | G | G1 | Ø | Ø1 |
|-----|----|----|----|----|---|----|----|----|----|----|
| 12 | 35 | 40 | 33 | 18 | 2 | 31 | 18 | 18 | 25 | 13 |
| 30 | 67 | 65 | 52 | 25 | 3 | 51 | 35 | 33 | 50 | 31 |

XTAZ30

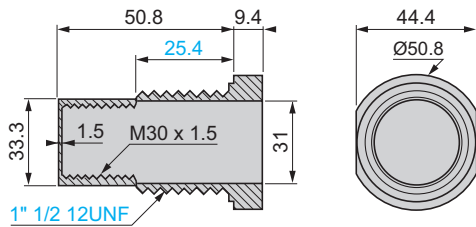

Capacitive proximity sensors

XT range

Cylindrical, non flush mountable. Plastic case

AC or DC supply

Wiring schemes

Connector version

M12 connector



4-wire \sim , PNP
NO + NC output, M12

XT218A1PCM12
XT230A1PCM12

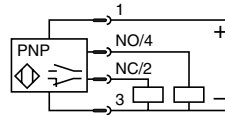

Screw terminal version

2-wire \sim

NO or NC output, selectable

XT230A2MDB

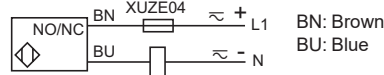

Pre-cabled version

Wire color

BU: Blue
BN: Brown
BK: Black

3-wire \sim , PNP
NO output

XT218A1PAL2
XT230A1PAL2
XT234A1PAL2

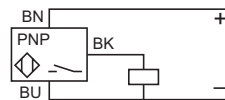

3-wire \sim , NPN
NO output

XT218A1NAL2
XT230A1NAL2

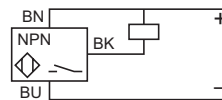

2-wire \sim
NO output

XT218A1FAL2
XT230A1FAL2
XT232A1FAL2

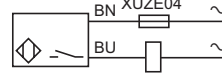

2-wire \sim
NC output

XT230A1FBL2
XT232A1FBL2

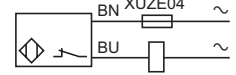

Adjustment

Sensitivity adjustment

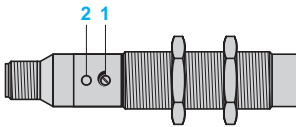

Adjustment from the side for **XT218A1**
XT230A2

Adjustment from the rear for **XT230A1**
XT232A1
XT234A1

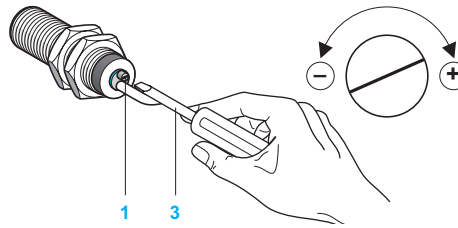

- 1 Adjustment potentiometer
- 2 LED
- 3 Adjustment using suitable screwdriver (included with sensor)

Setting-up

Minimum mounting distances (mm)

Side by side

Face to face

Facing a metal object

Mounted in support

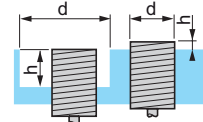
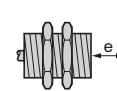
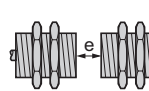
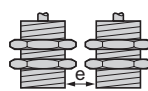

| | | | | | |
|--|-------------|---------------|---------------|--------------|-------------|
| XT218A1, M18 x 1 non flush mountable | $e \geq 40$ | $e \geq 6$ Sn | $e \geq 3$ Sn | $d \geq 60$ | $h \geq 20$ |
| XT230A1, M30 x 1.5 non flush mountable | $e \geq 60$ | $e \geq 6$ Sn | $e \geq 3$ Sn | $d \geq 90$ | $h \geq 30$ |
| XT230A2, M30 x 1.5 non flush mountable | $e \geq 60$ | $e \geq 6$ Sn | $e \geq 3$ Sn | $d \geq 90$ | $h \geq 30$ |
| XT232A1, $\varnothing 32$ plain, non flush mountable | $e \geq 65$ | $e \geq 6$ Sn | $e \geq 3$ Sn | $d \geq 100$ | $h \geq 30$ |
| XT234A1, $\varnothing 34$ plain, non flush mountable | $e \geq 65$ | $e \geq 6$ Sn | $e \geq 3$ Sn | $d \geq 100$ | $h \geq 30$ |

Fixing nut tightening torque: **XT218A**: 3 N.m (26 lb-in), **XT230A**: 8 N.m (71 lb-in).

Cable gland tightening torque: **XT230A2**: 4 N.m (35 lb-in).

| N | |
|-------------|----|
| NSYTRV42SF5 | 12 |

| X | |
|--------------|----|
| XT132B1FAL2 | 8 |
| XT218A1FAL2 | 12 |
| XT218A1NAL2 | 12 |
| XT218A1PAL2 | 12 |
| XT218A1PCM12 | 12 |
| XT230A1FAL2 | 12 |
| XT230A1FBL2 | 12 |
| XT230A1NAL2 | 12 |
| XT230A1PAL2 | 12 |
| XT230A1PCM12 | 12 |
| XT232A1FAL2 | 12 |
| XT232A1FBL2 | 12 |
| XT234A1PAL2 | 12 |
| XT512B1PAL2 | 8 |
| XT512B1PAM12 | 8 |
| XT512B1PBL2 | 8 |
| XT512B1PBM12 | 8 |
| XT518B1FAL2 | 8 |
| XT518B1FBL2 | 8 |
| XT518B1PAL2 | 8 |
| XT518B1PCL2 | 8 |
| XT518B1PCM12 | 8 |
| XT530B1FAL2 | 8 |
| XT530B1FBL2 | 8 |
| XT530B1PAL2 | 8 |
| XT530B1PCL2 | 8 |
| XT530B1PCM12 | 8 |
| XUZA118 | 12 |
| XXZ12 | 12 |
| XXZ30 | 12 |

Schneider Electric Industries SAS

Head Office
35, rue Joseph Monier
F-92500 Rueil-Malmaison
France

www.tesensors.com

The information provided in this documentation contains general descriptions and/or technical characteristics of the performance of the products contained herein. This documentation is not intended as a substitute for and is not to be used for determining suitability or reliability of these products for specific user applications. It is the duty of any such user or integrator to perform the appropriate and complete risk analysis, evaluation and testing of the products with respect to the relevant specific application or use thereof. Neither Schneider Electric nor any of its affiliates or subsidiaries shall be responsible or liable for misuse of the information contained herein.

Design: Schneider Electric
Photos: Schneider Electric