



Edition
10/2023

THE HEART OF AUTOMATION

SITOP Power Supply

Three reasons for SITOP: reliability, efficiency, and integration.

[siemens.com/sitop](https://www.siemens.com/sitop)

SIEMENS



SITOP PSU4200 – Fresh Power for basic applications: The new generation of these low-cost basic power supplies is quick to assemble, easy to operate, compact, and reliable. See [page 10](#) and technical details [on page 34](#).



[See highlight topics](#)



SITOP PSU6200 – The all-round power supply for a wide range of applications, whether it's for 24 V, 12 V, 48 V, control circuits in accordance with NEC Class 2, or environments at risk of explosion: See [pages 8-9](#) and technical details [on pages 29-31](#).

SITOP power supplies bring production plants to life.

An efficient power supply is a basic requirement for operating any plant, no matter the industry or need. Critical production processes can only be maintained if a constant power supply of the necessary quality is available for the automation system. For decades, SITOP – the heart of automation – has been bringing production plants to life. The complete, precisely coordinated range of products guarantees a reliable power supply, and is especially suited to the growing demands of our time.

Three good reasons for SITOP



Reliability

SITOP has proven its reliability in nearly all networks around the world. With a flexible, wide-range input, outstanding load characteristics, and all the relevant certifications, SITOP power supply units safeguard the availability of your plant. Add-on modules prevent problems on the line or DC side. And when upgraded to an uninterruptible power supply, the 24-V power supply units bridge power failures for a period of seconds, minutes, or hours. In the event of a fault-specific



Efficiency

Reduced energy costs are a valuable competitive advantage. SITOP makes an important contribution, because the primary switched-mode power supply units operate highly efficiently. For example, SITOP PSU6200 has an efficiency of up to 96.6 percent. Losses are low throughout the entire load range, even in no-load operation. This is because a power supply is rarely operated at full load. SITOP PSU8600, on the other hand, records power data from all outputs, which is then further



Integration

SITOP sets a benchmark in terms of integration: Complete integration of the SITOP PSU8600 power supply system and SITOP UPS1600 DC UPS in Totally Integrated Automation, the TIA Portal, and the new SITOP Manager saves time and money and facilitates fail-safe engineering. For the selectivity modules and the SITOP PSU6200 product line, S7 function blocks evaluate important diagnostic information. The SITOP UPS1600 can easily be integrated via USB or Ethernet to protect

overload or short circuit in the output circuit, selective disconnection of the feeder ensures continued operation because the supply to other loads is maintained. For highly critical applications, redundant power supply solutions are also an option. If a replacement is ever needed, our global customer service ensures the fastest possible delivery: All SITOP products can be supplied from stock.

processed in energy management systems. And via PROFlenergy, power supply outputs can be switched off selectively: for example, during breaks.

Efficiency also characterizes the product lifecycle. With the TIA Selection Tool, we offer you special tools to make it easy to select a power supply and DC UPS. We provide you with all the design data for all common CAE systems as well as the corresponding product documentation.

PC-based automation systems from power failures. And the SITOP library for SIMATIC PCS 7 enables a transparent 24-V supply in the process control system during ongoing operation. Besides PROFINET, SITOP PSU8600 and SITOP UPS1600 also communicate via OPC UA. With the OPC UA server, it's also possible to directly integrate units such as controllers or PCs into automation applications with OPC UA clients from different vendors.

Three SITOP categories for the different demands on an industrial power supply

Advanced power supplies

The switched-mode power supply units in the Advanced performance class are the optimal choice for maximum reliability and functionality as required in the process and automotive industries, in special-purpose machine manufacturing, and in harsh environments. The SITOP PSU8200 product line meets these extreme requirements due to their overload behavior, efficiency, and compactness. SITOP PSU8600 also offers a power supply system with open communication for optimal integration into the digital environment.

Standard power supplies

Our standard portfolio was designed for typical industrial applications like those in special-purpose machine manufacturing. The SITOP PSU6200 all-round power supply was developed on the basis of our experience with the proven SITOP smart product line. This new SITOP standard offers even higher efficiency, extensive diagnostic capabilities, and greater ruggedness.

Basic power supplies

From flat power supplies for distribution boards to cost effective basic power supplies and slim power supply units for control boxes – even in the low-performance range, SITOP leaves nothing to be desired. LOGO!Power offers you miniature power supply units in the LOGO! module design. And SITOP PSU4200 represents a solution that's both low-cost and reliable, with quick wiring and a power monitor for condition diagnostics.

Overview of SITOP product line

What an optimal power supply looks like depends on numerous factors – size, performance range, and functions, to name but a few. The extensive

range of SITOP products ensures that your power supply will always match your requirements.

Advanced power supplies



SITOP PSU8600

The power supply system for digitalization and Industry 4.0

The innovative SITOP PSU8600 power supply system is fully integrated into Totally Integrated Automation and the TIA Portal. It's integrated directly into networked automation applications via its Ethernet/PROFINET or Ethernet/IP interface or OPC UA. SITOP PSU8600 not only offers diagnostics options, it also supports the energy management of a plant or machine. The modular system can be expanded to 36 outputs and provides buffer and DC UPS modules for protection against power failures.

Pages 23–25



SITOP PSU8200

The technology power supply for demanding solutions

SITOP PSU8200 is ideal for complex plants and machines. The wide-range input allows it to be connected to any supply system and also to withstand large voltage fluctuations. The power boost briefly delivers up to three times the rated current. And in the event of an overload, you can choose between constant current with automatic restart or latching shutdown. The high degree of efficiency reduces energy consumption, while the compact metal enclosure saves space.

Pages 27–28

Standard power supplies



SITOP PSU6200

The all-around power supply for a wide range of applications

SITOP PSU6200 is the extremely high-performance power supply for standard 24, 12, and 48 V standard applications, in addition to 24 V applications in environments at risk of explosion. The compact, energy-efficient power supply units offer comprehensive functions and features for focused diagnostics, fast installation, and dependable operation. Whether it's LED status indicators, integration into preventive maintenance, push-in terminals, or rugged input – SITOP PSU6200 has it all.

Pages 29–31



SITOP smart

The powerful standard power supply

SITOP smart is the optimal power supply for many 24-V and 12-V applications, featuring powerful performance and an affordable price. Even large loads can be easily switched on, due to its overload characteristics that provide 1.5 times the rated current for 5 seconds. And with a rated capacity of 120 percent at ambient temperatures up to 45°C, these slim power supply units are among the most reliable of their kind.

Pages 32–33

Basic power supplies



SITOP PSU4200

The cost-effective basic power supply

SITOP PSU4200 is the new power supply series for basic requirements in an industrial environment, offering all the important functions at a low cost – without compromising quality and reliability. Fast wiring, compact structure, and a power monitor make these single and 3-phase power supply units practical to use.

Page 34



LOGO!Power

The flat power supply for distribution boards

Small. Clever. LOGO!Power. The fourth generation of the globally proven miniature power supply units with a flat, stepped profile features high performance in a small space. The comprehensive functionality with flexible installation, current monitoring, and high energy efficiency permits universal use in applications with 5 V, 12 V, 15 V, and 24 V.

Pages 35–36

SITOP DC/DC converters



SITOP DC/DC converters

Stable power supply despite fluctuating DC voltage

SITOP DC/DC converters ensure a stable control voltage: in battery-powered vehicles, as a “refresher” in long lines, in power stations, and in the converter DC link in wind turbines or machine tools.

Page 38

SIMATIC Design

The optimal supply for SIMATIC S7 and more

Page 37

Special designs

Equipped for special functions and conditions

Pages 39–40

SITOP PSU8600 – the power supply system for digitalization and Industry 4.0

Complex plants set high requirements for the efficiency, flexibility and reliability of the components used. The innovative power supply system SITOP PSU8600 fulfills them all – with its unique functionality, diagnostics capability,

modular expandability and complete integration in TIA or via an OPC-UA server in many other systems.

Product overview

Advanced power supplies

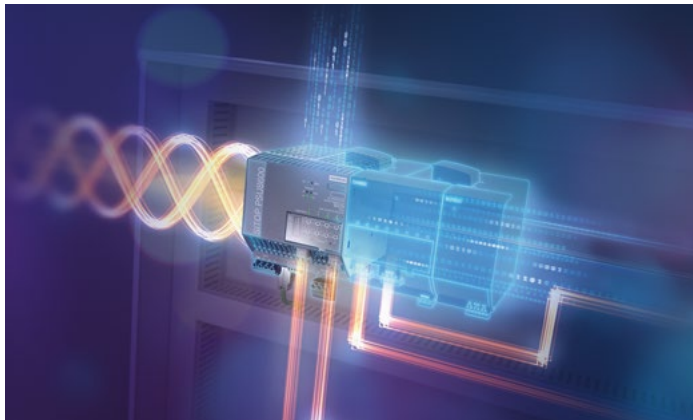

SITOP PSU8600 – in dialog with your power supply

The SITOP power supply system includes the SITOP PSU8600 basic unit, the SITOP CNX8600 expansion modules, the SITOP BUF8600 buffer modules and the SITOP UPS8600 UPS module with the BAT8600 battery modules. It can be integrated seamlessly in TIA Portal, SIMATIC PCS 7 and WinCC. Due to the comprehensive data exchange over PROFINET or OPC-UA, the power supply is in constant dialog with the control unit and thus enables preventive maintenance and energy management in the control circuit. With a new version of the 4 x 10 A basic device, communication is now also possible via EtherNet/IP.



Did you know that...

with a new version of the 4 x 10 A basic device, communication is now also possible via EtherNet/IP?

SITOP PSU8600 System – modular and integrated



SITOP BUF8600
buffer modules



SITOP CNX8600
expansion modules



SITOP PSU8600
base units



SITOP PSU8600
UPS modules



SITOP PSU8600
battery modules

Integration



Controller



Monitoring

PROFINET,
OPC-UA,
EtherNet/IP



Engineering with TIA Portal



Open communication

The modular system toolbox

Product overview



Base unit
Power supply 24 V/20 A or 40 A with one or four selectively monitored outputs



Expansion modules
Expansion to up to 36 selectively monitored outputs



Buffer modules
Bridging short power failures



DC UPS and battery modules
Bridging long power failures

Data sheet



Fast and easy integration in the automation

The SITOP PSU8600 power supply system can be integrated seamlessly in TIA portal, SIMATIC PCS 7 and WinCC. Two industrial PROFINET or EtherNet/IP ports enable the system to be integrated easily into the automation environment. Vendor-independent data exchange is possible through the open communication interface OPC UA.

Parameterization, operation, and monitoring of the PROFINET versions can be performed via the user-friendly SITOP Manager engineering and diagnostics software. The integrated web server enables remote access. The support of PROfinergy, allows specific outputs to be switched off to save energy and costs during break periods.

[More about SITOP Manager](#)



High degree of flexibility thanks to modular system unit

The compact basic unit provides one or four individually adjustable outputs – and thus up to four power supplies in one device. Each output can be set flexibly to 4–28 V, even dynamically during operation and with selective monitoring for over current. The “system clip link” can be used to extend the power supply system with various modules without additional wiring work and therefore expand it to up to 36 outputs and provide protection against supply system outages.



High plant availability

The comprehensive diagnostics options of the SITOP PSU8600 power supply system provide the basis for preventive maintenance: Faults can therefore be detected, assigned and corrected in the shortest possible time. To ensure that a short-circuit or overload at a single consumer doesn't bring the entire plant to a standstill, all outputs whose voltage and current threshold can be set individually are selectively monitored and switched off individually in the event of a fault. Because the current of each output can be recorded continuously and transmitted via a communication interface, overload states can be detected early. With a suitable buffer and battery modules, supply system failures can be bridged from seconds to hours, thus preventing a plant shutdown.

SITOP PSU6200 – the all-around power supply for a wide range of applications

A new benchmark in the area of standard power supplies: With its award-winning industrial design, space-saving width, optimized terminals, comprehensive diagnostics options, and high operational reliability, SITOP PSU6200 offers attractive

prospects for a variety of different applications and areas of operations.

[Product overview](#)

Standard power supplies



Did you know that ...

only one digital input is required on the PLC for transferring comprehensive diagnoses?

Diagnostics monitor/Diagnostics interface

SITOP PSU6200 power supply units as of 24 V/10 A, 12 V/12 A and 48 V/5 A have a diagnostics monitor and a diagnostics interface. The diagnostics monitor indicates their operating status, current utilization, and end of service life via 5 LEDs.

The diagnostics interface outputs a serial code to a digital input of a PLC that is evaluated by a function block. A WinCC faceplate makes visualization easy:

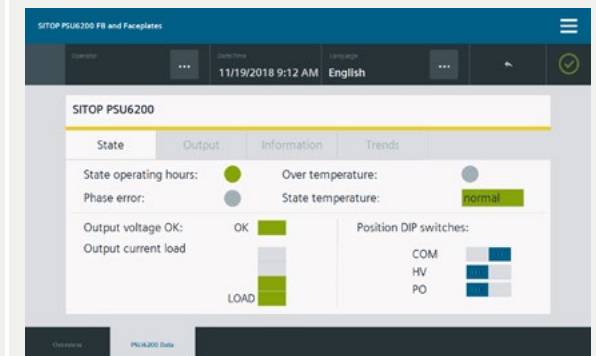
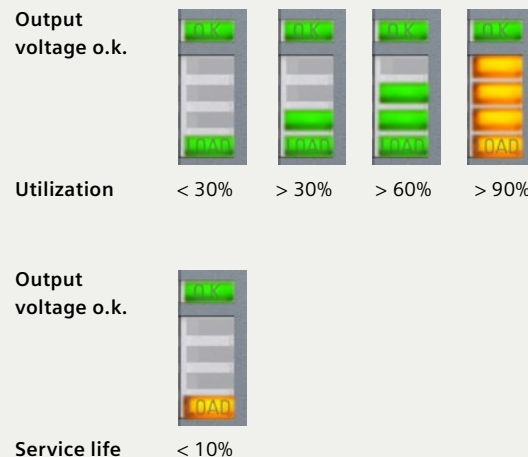

[Learn more](#)



Focused diagnostics. Top integration.

With SITOP PSU6200 you benefit from a high degree of transparency during operation. The integrated diagnostics monitor, in the more powerful units, has an LED display on the housing which enables immediate identification of how high the power supply's load is or whether the unit is coming to the end of its life. In this way it is possible to respond to critical states to prevent unforeseen plant failure.

Via the power supply unit's diagnostics interface, additional important operating parameters and statuses such as current, voltage, overload, operating hours, temperature, and device/type can be transferred to the controller and incorporated in condition monitoring. The signal is evaluated by means of a free S7 function block. In addition, a faceplate for visualizing the data on an HMI is available for download.

The all-around power supply

Product overview



Data sheet

Fast installation. Top efficiency.

Space savings, front labeling, push-in terminals – with SITOP PSU6200, you make no compromises when installing and wiring. Inside the control cabinet, space is a valuable commodity. You can make even better use of this space, with the extremely narrow width of these power supply units. And with optimized heat dissipation and an efficiency rate up to 96.6 percent, the units require no lateral clearance between components, which also saves space on the DIN rail.

The all-around power supplies also facilitate and speed up fail-safe wiring. Unique terminal labeling makes correct wire connection easier, and push-in terminals make wiring fast. An additional, uniquely identified minus terminal also makes it easier to ground PELV (protective extra-low voltage) circuits according to the Machinery Directive.



Dependable operation. Top reliability.

Dependable overload behavior, robust input, and a metal enclosure for optimal heat dissipation – with SITOP PSU6200, you're on the safe side. Their extra power means that the high-performance power supply units provide a 50 percent higher rated current for up to five seconds in the event of an overload. If the overload is extremely high, they keep the current constant and change to hiccup mode for self-protection only when the output voltage drops to 15 volts. Once the overload has been corrected, they continue in normal operation.

You're also optimally equipped to handle bad line quality. With the robust wide-range input for AC and DC voltage, these all-around power supplies are well-protected against undervoltages and overvoltages from the grid. In the event of a phase failure, the 400-V units even permit continuous two-phase operation. The higher-performance power supply units also have active power factor correction (PFC) that keeps the reactive current and inrush current low.

New redundancy, buffer, and selectivity modules in the attractive SITOP PSU6200 design ensure even higher availability. [See pages 13 and 14.](#)

New:

Extensive range of Ex versions for use in gaseous environments at risk of explosion, Zone 2.

[Find out more](#)



Add-on modules

SITOP PSU4200 – The power supply with Fresh Power for basic applications

Adding new vitality to basic power supplies: The low-cost SITOP PSU4200 power supply for basic applications in an industrial setting will impress with its high efficiency and reliability, fast wiring, and improved sustainability. SITOP PSU4200 offers

a wide range of devices for different power ranges: Choose from 1-phase 24 V power supply units rated 3 A, 5 A, 10 A, or 20 A, and 3-phase 24 V power supply units rated 10 A and 20 A.

Product overview

Basic power supplies



Did you know that ...

the SITOP PSU4200 power supply units deliver a constant current in the event of overload and therefore don't immediately disconnect?



Fresh Power for more efficiency

SITOP PSU4200 leaves nothing to be desired, even with the 24 V supply for basic applications: The push-in connection system, front-mounted, easily accessible terminals, and clear terminal labeling, allows for quick and easy installation of these power supply units. They can also be mounted directly alongside each other on the DIN rail with no lateral clearances. Together with their compact design, this saves space in the control panel.

A high efficiency rating of up to 93% ensures minimal power loss combined with minimal heat generation and a long service life. This also saves fan power in the control panel. The 1-phase 20 A power supply unit demonstrates its efficiency in the form of reduced reactive power due to active PFC (Power Factor Correction).



Fresh Power for more transparency

The LEDs on the integrated power monitor show the current operating status of the SITOP PSU4200 at a glance. A green LED indicates that everything is in order (DC OK / 24 V / 0-85%). A yellow LED, on the other hand, warns of a temporary increase in consumer current (DC in limit range: > 85%), caused by overloading or power supply parameters in the limit range. And if the LED is off, that means no current is flowing.

In addition, the power supply units can be connected to the PLC via a DC OK alarm contact (24 V) and can thus be integrated into the automation system for evaluation.



Fresh Power for uninterrupted reliability

Even when the going gets a little rough with basic applications, you can rely on SITOP PSU4200: The high level of reliability of these basic power supply units make sure of that, with full load current up to +60 °C and a temperature range of -25 °C to +70 °C. Derating occurs only from +60 °C (2.5%/K). The adjustable output voltage from 24 to 28 V DC offsets voltage drops on long lines.

For maximum reliability and availability, you can also easily expand the power supply units with the SITOP DC UPS and add-on modules. [See pages 11-14.](#)

SITOP ensures reliable 24-V supply – even when the power fails

Power outages can bring a plant to a standstill, with high costs in terms of both time and money. The SITOP DC UPS systems with different types of energy storage devices and communication

interfaces offer solutions for all buffering time and plant integration requirements.

Uninterruptible power supply

DC UPS module For expansion to an uninterruptible 24-V power supply

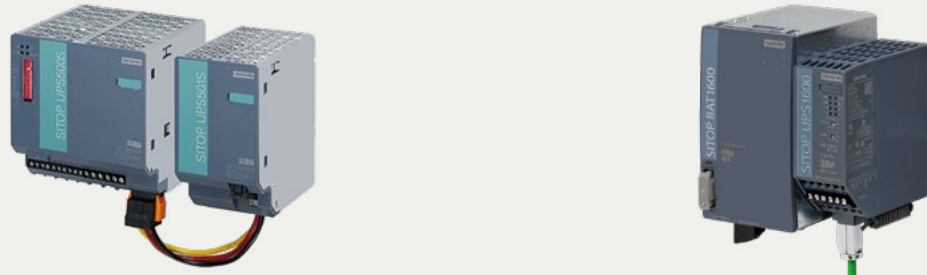

Data sheet

SITOP DC UPS with capacitors

These high-capacitance double-layer capacitors (Ultracaps) store sufficient energy to shut down PC-based systems safely.

Totally maintenance-free

The capacitors have an extremely long life even at high ambient temperatures. No maintenance or replacement of the energy buffer is required, which means that the DC UPS pays for itself within a short time. And because the capacitors do not emit any gas, no ventilation of the control cabinet is required. Short recharging times quickly restore buffering capability following a power failure.

For use both inside and outside the control cabinet

The buffering time of the UPS500S for DIN rail mounting can be extended by adding UPS501S expansion modules.

- Variant expandable up to 20 kW for longer buffering times
- Capacitors eliminate replacement of batteries
- Long life even at high temperatures
- No ventilation of the installation site required
- Communication via contacts or USB
- Easy engineering via SITOP Manager (as of V1.1, [see page 16](#) for more details)



Data sheet

SITOP DC UPS with battery modules

Compact DC UPS modules ensure continued operation, even over a period of hours, depending on battery capacity and power requirements.

High system availability with battery management

Sophisticated battery management and temperature-controlled charging offered by the UPS1600 ensures maximum battery service life. The new BAT1600 battery modules calculate their health and remaining service life, so you can replace batteries in good time and improve availability.

- SITOP UPS1600 DC UPS modules with 24 V and up to 40 A and new BAT1600 battery modules up to 38 Ah
- BAT1600 battery modules with integrated electronics and battery cells based on lithium iron phosphate (LiFePO4) or lead
- Monitoring of operational readiness, battery feeder, charging status, and service life



Did you know that ...
 the function "State of Health (SOH)"
 can be used to evaluate the
 remaining service life of the new
 battery modules SITOP BAT1600?

SITOP module for 24-V buffering	Buffer module	UPS500	UPS1600	
Energy storage device				
24 V buffer time	max. 10 s	Minutes	Hours	
Storage medium	Electrolytic capacitors	Double-layer capacitors	Lead batteries	Lithium batteries
Service life (also temperature-dependent)	++	++	•	+
Application area (temperature, ventilation)	+	++	•	+
UPS module/electronics				
max. rated output current	40 A	15 A	40 A	
Overload capacity	++	+	++	
Interfaces		I/O, serial, USB	I/O, USB, Ethernet/PROFINET	
Operating and diagnostic information via				
– Signaling contacts		•	•	
– OPC UA server, Web server, S7 FBs, WinCC faceplate			•	
Shutting down multiple PCs/PLCs			•	
Start from battery without mains voltage (island operation)			•	
Engineering via SITOP Manager		•	•	
Engineering via TIA Portal, STEP 7, WinCC, or OPC UA			•	
SITOP library for SIMATIC PCS 7			•	

Extremely communicative

Optional communication via USB or Industrial Ethernet/PROFINET. With open communication via Ethernet, configuration and diagnostics are conveniently performed by the SITOP Manager. This PC software with a user interface based on a Web browser permits simple parameterization: for example, for safely shutting down multiple PCs.

The UPS1600 can even be fully integrated into TIA via PROFINET. Remote monitoring is possible with support from the integrated web server.

- Communication via contacts, USB, or two Ethernet/PROFINET ports
- Easy engineering and extensive diagnostics in the TIA Portal
- OPC UA server for the flexible integration of a wide variety of automation, operating, and monitoring systems
- User-friendly SITOP Manager engineering and diagnostics tool for simple integration into open systems (more details on page 16)

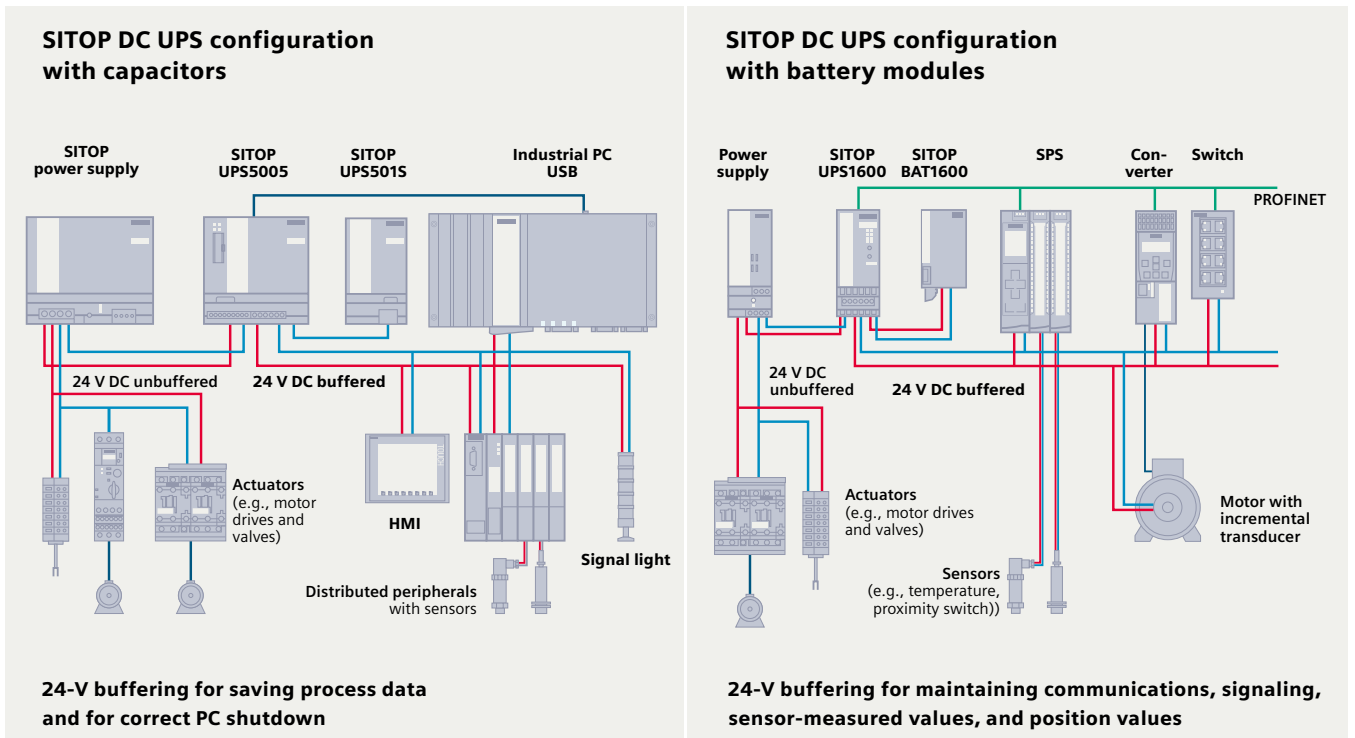

SITOP add-on modules – all-round protection à la carte

Processes and plants that are critical for a company's business generally require additional protection measures.

SITOP add-on modules individually protect your production against many sources of risk.

Add-on modules

Add-on modules

For increasing system availability to all-round protection



Selection matrix of the SITOP add-on modules for protection from...	Redundancy module	Selectivity module	Buffer module	DC UPS with capacitors	DC UPS with batteries
Failure of a power supply unit	•				
Overload in the 24-V circuit		•			
Power failure up to the seconds range			•	•	•
Power failure up to the minutes range				•	•
Power failure up to the hours range					•



Data sheet

Selective disconnection of faulty 24-V feeders

The SITOP selectivity modules are specifically tailored to switched-mode power supplies. The modules permit brief current peaks and switch off the electricity for longer overloads, even on long, thin cables and with creeping short circuits in which the current is limited by the high ohmic resistance. In this case the circuit-breakers do not trip, or they trip too late, even if the power supply could deliver the current. The selectivity modules reliably disconnect the faulty load circuits, and the supply to the other loads continues with absolutely no interruption so that total failure of the plant can be avoided. The affected feeder is indicated by an LED. The option with single-channel signaling also allows remote output-specific fault location.



Data sheet

Safeguarding against failure through redundancy

Two power supply units can be connected via the SITOP redundancy module for additional failure safety. If one unit fails, the other automatically takes over the power supply function. Even in the event of a short circuit inside a power supply unit, the power supply remains reliable. With its high dielectric strength, the new RED1200 redundancy module also decouples power supplies without output voltages up to 48 V.

The new SEL1200 and SEL1400 four or eight-channel modules also have an interface with comprehensive diagnostics options for each output.



Data sheet

Buffer module bridges brief power failures

Although power failures usually last only a fraction of a second, they can cause costly and time-consuming damage. In combination with the 24-V power supply units, the buffer module bridges short-duration voltage dips with its electrolyte capacitors.

Configuration with redundancy module

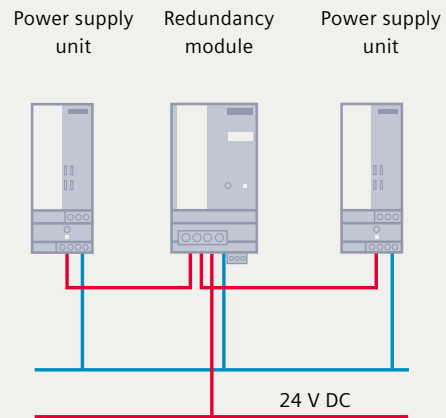

Configuration with selectivity module

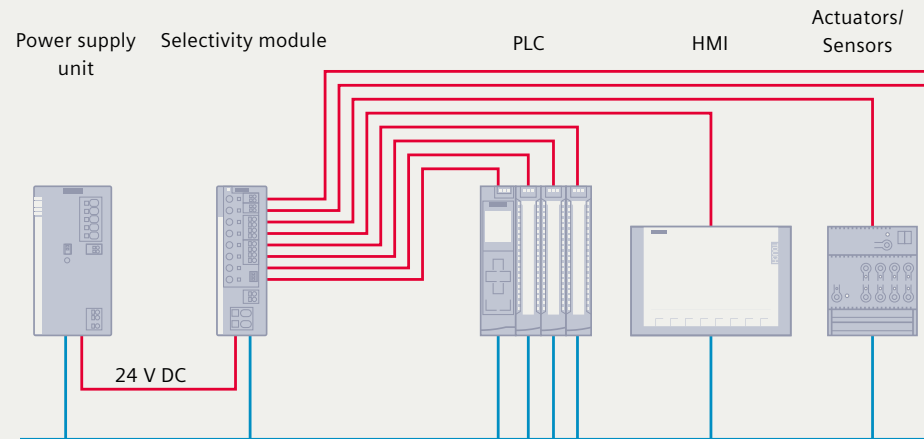

Configuration with buffer module

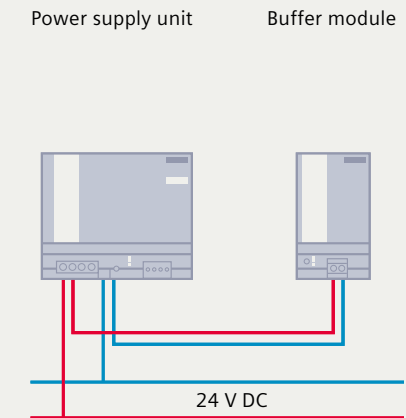

Your benefits with the redundancy module:

- Highly secure DC supply due to a redundant design
- Reliable supply even when one power supply fails
- Compact redundancy modules for power supply units up to 48 V and 40 A
- 24-V/NEC Class 2 redundancy module limited to 100 W
- Decoupling of parallel-connected power supply units to enhance performance or of series-connected power supply units to increase voltage

Your benefits with the selectivity module:

- Protection against overloads and short circuits in the 24-V circuit
- Reliable tripping, regardless of the line resistance
- SEL1200: switch-off characteristic for standard protection and high starting currents, 48 V 4x 10 A version available
- SEL1400/PSE200U: power limiting to meet high protection requirements by stabilizing the 24 V
- Sequential connection reduces total inrush current
- Common signaling contact or evaluation of individual channels
- SEL1200/1400: 4 or 8 outputs, each with diagnostics of voltage, current, set threshold, reason for disconnection (if applicable)
- PSE200U: 4 outputs with voltage measuring point for current ($1 \text{ V} \triangleq 1 \text{ A}$)

Your benefits with the buffer module:

- Inexpensive protection against power failure up to several seconds
- Support of power supply unit for temporarily increased power requirements
- High load current up to 40 A
- Connection to the power supply unit only via two lines

SITOP 48 V supply – with add-ons for improved availability

Smaller cable cross-sections or a lower voltage drop on the line, smaller line losses and an improved voltage level at the consumer end – the 48 V supply voltage is beneficial, especially for applications with a higher power range or involving greater distances.

With 48 V power supply units, the lower current flow often helps achieve a slightly higher efficiency rating than with the 24 V versions. In electric motors, 48 V enables improved dynamics during acceleration. And because 48 V is below the 60 V DC level classed as non-hazardous to humans, there is no need for touch protection for the live components.

48 V supply



		Power supplies			Add-on modules		
		Advanced	Standard	Special designs	Redundancy modules	Selectivity module	
1-phase			SITOP PSU6200 48 V/5 A and 10 A	SITOP PSU3600 3...52 V/10 A	SITOP PSU100E 48 V/5 A	SITOP RED1200 10...58 V/20 A, 40 A and 80 A	SITOP SEL1200 48 V/4 x 10 A
3-phase		SITOP PSU8200 48 V/10 A and 20 A	SITOP PSU6200 48 V/5 A, 10 A and 20 A				

Power supplies for different requirements

To reliably supply industrial 48 V applications, SITOP also offers single and 3-phase 48 V power supply units in various product lines.

Fail-safe operation and selective disconnection for 48 V

Additional safety is assured by the appropriate redundancy modules and a selectivity module with four 10 A outputs to safeguard 48 V feeders, e.g. to protect motors or solenoid valves. These add-on modules for 48 V improve availability by providing a reliable continued supply following a power supply unit outage, and by selectively disconnecting a 48 V feeder affected by an overload or short circuit.

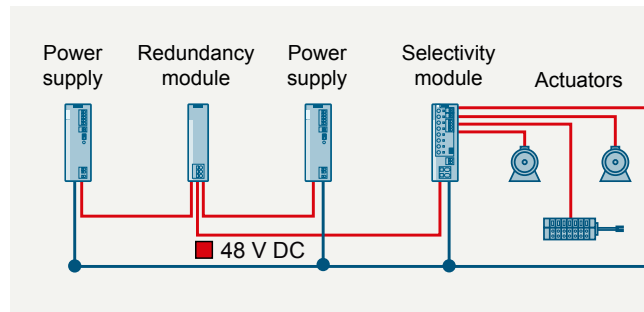

Uninterruptible power supply for 48 V

To also protect 48 V consumers against power failure, two 24 V power supplies with an uninterruptible power supply (DC UPS) can be connected in series via two redundancy modules. For switching details, see the Application Note on page 17:

[Application note](#)

SITOP devices with explosion protection – from the power supply to comprehensive 24 V protection

Whether caused by combustible substances, dust, gas, vapor, or mist: In particular working environments just a spark or a hot surface may be enough to trigger the most severe work accidents through an explosion and put human lives at risk.

For reasons of industrial safety, electronic devices in these environments must be appropriately designed and certified. That also applies to power supply units.

Explosion-proof devices

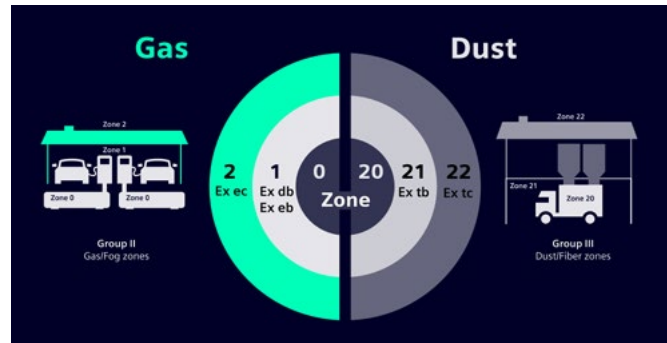

Safe 24 V power supply in an environment at risk of explosion

Many SITOP power supplies and add-on modules are also available in Ex versions for Zone 2, in which an explosive atmosphere may develop as a result of gases, vapors, or mist. To meet these requirements, PCBs in most SITOP devices come with a conformal coating for use in Ex zones. That means they meet ignition protection class EX ec (enhanced safety) for Zone 2, and are simultaneously more robust for use in harsh environments.

Ex zones classified by frequency and duration of hazardous explosive atmosphere

Explosive zones are classified according to how often and how long a hazardous explosive atmosphere develops there. Zone 2 defines areas in which, under normal working operations, a hazardous explosive atmosphere resulting from a mixture of air and combustible gases, vapors, or mist is not expected at all, is expected only rarely, or only for a short period.

1-phase power supplies

[SITOP PSU8200 Ex 24 V/40 A](#)

[SITOP PSU6200 Ex 24 V/5 A, 10 A, 20 A](#)

[LOGO!Power Ex 24 V/4 A](#)

1-phase power supplies in SIMATIC design

[SIMATIC S7-1200 PM1207 DC 24 V/2,5 A](#)

[SIMATIC S7-1500 PM1507 DC 24 V/3 A, 8 A](#)

[SIMATIC ET 200SP PS 24 V/5 A, 10 A](#)

3-phase power supplies

[SITOP PSU6200 Ex 24 V/5 A, 10 A, 20 A, 40 A](#)

Add-on modules

[Redundancy module SITOP RED1200 Ex 24V/48 V/40 A](#)

[Selectivity module SITOP SEL1200 Ex 24 V/8 x 10 A](#)

[Selectivity module SITOP SEL1400 Ex 24 V/8 x 10 A](#)

[Buffer module SITOP BUF1200 Ex 24 V/40 A/300 ms](#)

Uninterruptible power supply with battery modules

[DC UPS module SITOP UPS1600 Ex 24 V/20 A with and w/o Ethernet/PROFINET interface](#)

[Battery modules SITOP BAT1600 Ex 24 V/3.2 Ah, 7 Ah lead](#)

Uninterruptible power supply with capacitors

[DC UPS module SITOP UPS500 Ex 24 V/15 A/5 kW and expansion module UPS501 5 kW](#)

Comprehensive support from planning to operation

No matter how many requirements a power supply must meet, SITOP always optimally supports your planning process – from product selection and mechanical and electrical design to project-specific plant documentation and engineering. With the TIA Selection Tool, you can select your power supply, add-on modules, and DC UPS faster and order it directly. In addition, you will automatically receive

the required CAD data and circuit diagram macros. And using the TIA portal, you can even simply and reliably parameterize and diagnose the modular SITOP UPS8600 power supply system and the SITOP UPS1600 DC uninterruptible power supply.

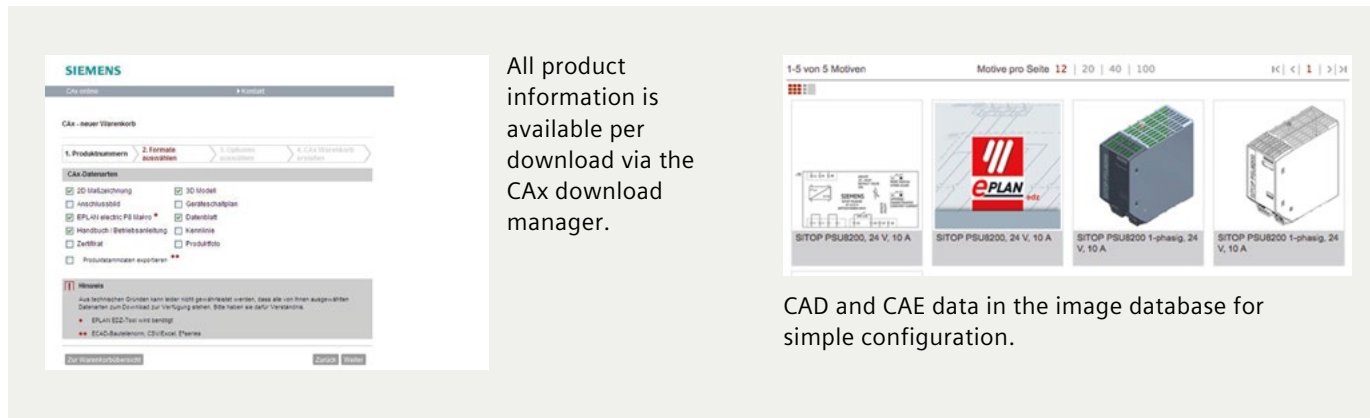

All product information is available per download via the CAx download manager.

CAD and CAE data in the image database for simple configuration.

Efficiency starts with selection

With just a few mouse clicks, the TIA Selection Tool guides you to the optimal power supply for your requirements. Simply enter the relevant parameters. If there are multiple solutions, an overview offers a comparison table containing several devices. Once you've opted for a power supply, you can easily select the appropriate redundancy, selectivity, and DC UPS modules. You can then export the resulting product configuration to various CAD, CAE, and engineering systems (like the TIA Portal) and continue to use it. With a single mouse click, you can transfer the selected products to the Industry Mall shopping cart and conveniently order them from there. The 24-V consumer view in the TIA Selection Tool helps you easily select the power supply for your project by automatically calculating the power requirements of the automation products to be supplied.

Everything you need for planning

Additional information – including 3D data, circuit diagram macros according to IEC or ANSI, certificates, and operating instructions – are available at the click of a mouse. With the aid of the CAx Manager, you can download engineering data in the DXF, STEP, EPLAN, and eCl@ss advanced formats and apply it directly to your project engineering. Not only does this save you a significant amount of valuable engineering time, but you also benefit from the configurable manuals when creating custom project documentation using My Documentation Manager.

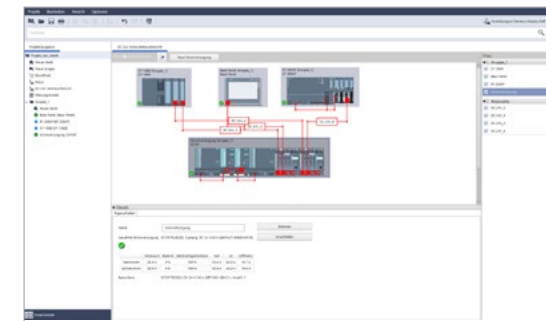

TIA Selection Tool: In the 24-V DC power consumer view, the necessary SITOP power supply can be easily selected for the chosen automation products.

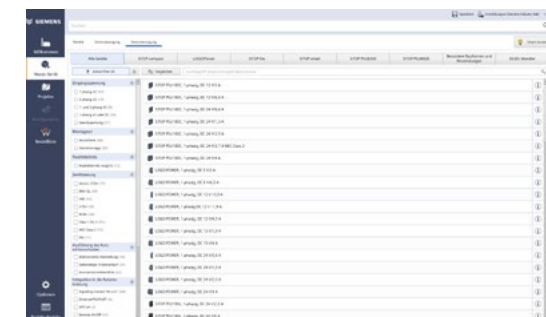

TIA Selection Tool: Power supply selection based on technical specifications.



Did you know that...

SITOP PSU8600 and SITOP UPS1600 (version with IE/PN interface) have integrated Web servers that they can use for commissioning and remote diagnostics?

[More about SITOP PSU8600](#)

[More about SITOP UOS1600](#)

Convenient engineering in the TIA Portal

You can easily perform the engineering tasks for the SITOP PSU8600 power supply system and the SITOP UPS1600 uninterruptible power supply via the TIA Portal. Device selection and network connection are a simple matter of drag-and-drop or copy-and-paste. In addition, function blocks for SIMATIC S7-300, 400, 1200, and 1500 are available for integrating the power supply system and DC UPS into STEP 7 user programs. There are also tailor-made faceplates to visualize the operational and diagnostic data using SIMATIC operating and monitoring systems. All of this helps reduce engineering effort and saves costs.

Your advantages through system integration of SITOP UPS1600 and SITOP PSU8600

- Time and cost savings during configuration and operation
- Convenient engineering in the TIA portal
- Quick product selection and network integration in PROFINET
- Comprehensive parameterization of devices
- Comprehensive diagnostic options
- Simple integration into STEP 7 user programs with function blocks for S7-300/400/1200/1500
- Fast integration into operation and monitoring with faceplates for SIMATIC panels and SIMATIC WinCC



[siemens.com/
tia-selection-tool](http://siemens.com/tia-selection-tool)

[More about TIA Selection Tool](#)

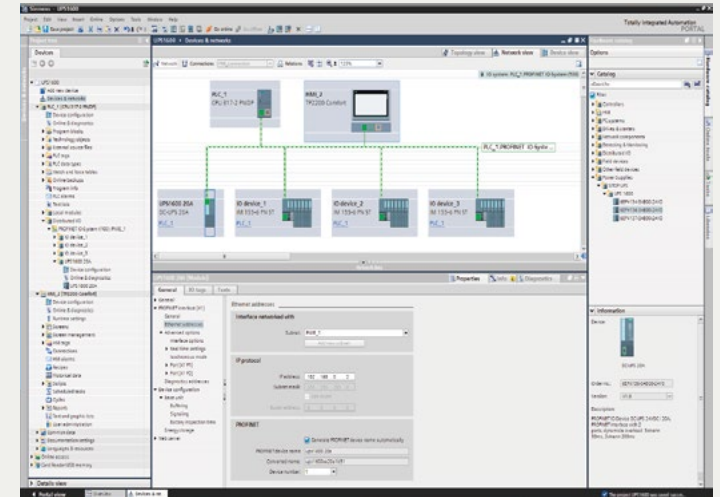

Integrating the SITOP UPS1600 DC UPS into PROFINET is easy and fail-safe via the TIA Portal.

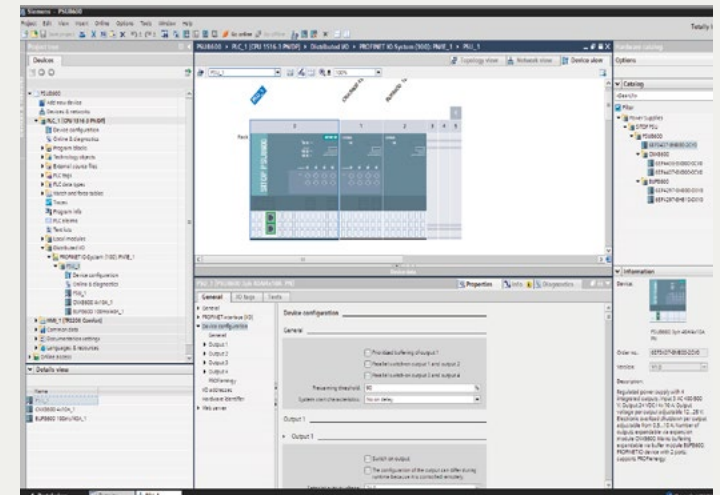

Configuring and setting parameters for the PSU8600 power supply system in the TIA Portal is both intuitive and convenient.

SITOP Manager – the software for easy integration of SITOP PSU8600, UPS500, and UPS1600 in open systems

Optimal interoperability with different control systems: SITOP Manager – the Windows software for the SITOP PSU8600 power supply system and SITOP uninterruptible power supplies – is available free of charge.



Did you know that...

with the SITOP Manager from Version V1.1, you can configure and diagnose uninterruptible SITOP power supplies with a USB interface, which also includes SITOP UPS500 and predecessors of UPS1600?

High performance for configuration

With the SITOP Manager software, all SITOP devices with a PROFINET or USB interface can be parameterized and diagnosed via a PC with the Windows 7 or 10 operating system – this is ideal, especially if plant configuration and programming isn't performed via the TIA Portal or SIMATIC Step 7. With a user interface based on a Web browser, the application can also run on mobile terminals and automatically adapts the display size. With the user-friendly SITOP Manager software, it's easy to parameterize the SITOP PSU8600 power supply system and the SITOP uninterruptible power supplies – for example, to define output voltages and current thresholds or to safely shut down PCs in the event of a power failure.

Uncompromising when it comes to security

Communication between SITOP Manager and the connected power supplies is via the open, multi-vendor, Ethernet-based OPC UA communication standard. This standard meets extremely high security requirements for secure data transmission.



[siemens.com/
download-smgr](https://www.siemens.com/download-smgr)

More about SITOP Manager in SIOS

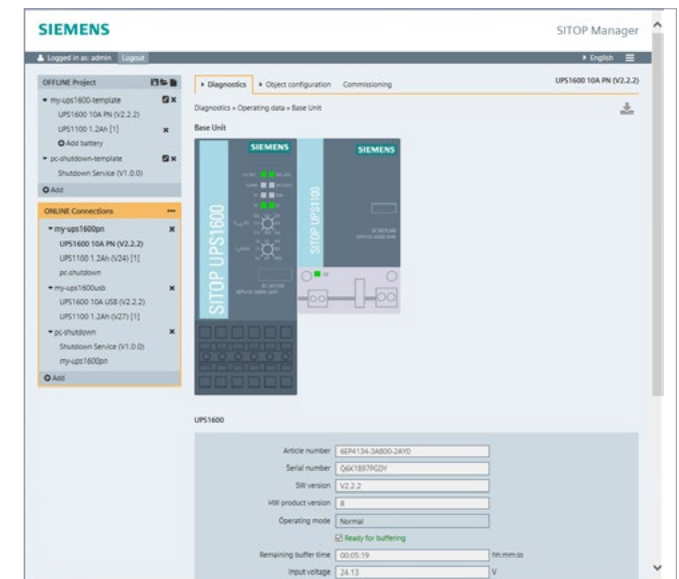

The status of SITOP devices with a PROFINET or USB interface can be conveniently accessed via SITOP Manager's online diagnostics. Here is the operational data from SITOP UPS1600.

SITOP – the right power supply for every application

Selection matrix of the SITOP DIN rail power supply units according to performance data and range of functions			Advanced power supplies	Standard power supplies	Basic power supplies	SIMATIC Design	DC/DC converters	Special designs						
			SITOP PSU8600 – power supply system with PROFINET and OPC UA	SITOP PSU8200 – The technology power supply for demanding solutions	SITOP PSU6200 – the all-around power supply for a wide range of applications	SITOP smart – The powerful standard power supply	SITOP PSU4200 – Fresh Power for your basic applications	LOGO!Power – The flat power supply for distribution boards	SITOP in SIMATIC design – The ideal power supply for SIMATIC S7 and more	Stable power supply despite fluctuating DC voltage	Equipped for special functions and conditions			
			Input	AC/DC	1,3 ~	1,2,3 ~ =	1,3 ~ =	1,3 ~	1,3 ~	1 ~ =	1,3 ~ =	1,3 ~ =	1,3 ~ =	
			Rated power up to approx.	P		960 W	960 W	960 W	960 W	480 W	100 W	240 W	480 W	960 W
			Rated output voltages	U		DC 5–24 V	DC 24/36/48 V	DC 12/24/48 V	DC 12/24 V	24 V DC	DC 5/12/15/24 V	24 V DC	DC 12/24 V	DC 12/24/48/3 ... 52 V
			Rated output currents (24 V)	I		20–40 A	5–40 A	1.3–40 A	2.5–40 A	3–20 A	0.6–4.0 A	2–10 A	2–20 A	2.1–40 A
			Overload behavior	P _{max}	 	 								
			Energy efficiency		+++ 	+++ 	+++	++	++	+	+++	++		
			Automation integration			DC o.k. Remote on/off	DC o.k. Diagnostics interface	DC o.k.	DC o.k.	ET 200SP/PRO: DC o.k.	> 240 W: DC o.k.	in some cases DC o.k.		
			Explosion protection: ATEX, IECEx, CCC, or FM		•	•			•	•				
			Marine approval: DNV or ABS		•	•	Pending	•		•	•	•	•	
			Ambient temperature range		–25...+60 °C	–25...+70 °C	–25...+70 °C from 24 V/3,7 A: –30...+70 °C	–25...+70 °C	–25...+70 °C	–25...+70 °C	0 ... +60 °C ET 200SP: –30 ... +70 °C	–25...+70 °C	–25...+70 °C	
			Redundancy module		•	•	•	•	•	•	•	•		
			Selectivity module	 I >	integrated	•	•	•	•	•	•	•	•	
			Buffer module	 s	integrated	•	•	•	•	BUF1200	BUF1200	BUF1200	BUF1200	
			DC UPS with Ultracaps	 min	integrated	•	•	•	•	•	•	•	•	
			DC UPS with batteries	 h	integrated	•	•	•	•	•	•	•	•	

¹⁾ Power boost function for basic devices with one output

Selection table SITOP power supplies

Product overview

Input voltage	Output current	Advanced power supplies		Standard power supplies		Basic power supplies			SIMATIC design	SITOP DC/DC converter	Special designs	
		SITOP PSU8600	SITOP PSU8200	SITOP PSU6200	SITOP smart	SITOP PSU4200	LOGO!Power	SITOP compact				
DC 24-V output voltage												
1-phase 120 V, 230 V AC	0.6 A							6EP3330-6SB00-0AYO	6EP1331-5BA00			
	1.3 A			6EP3331-7SB00-0AXO				6EP3331-6SB00-0AYO	6EP1331-5BA10			
	2 A									6ES7307-1BA01-0AA0	6EP1331-1LD01 6EP3323-0SA00-0BYO	
	2.5 A			6EP3332-7SB00-0AXO	6EP1332-2BA20			6EP3332-6SB00-0AYO	6EP1332-5BA00	6EP1332-1SH71	6EP3332-0TA00-0AYO	
	3 A						6EP3332-3SB00-0AXO			6EP1332-4BA00		
	3.7 A			6EP3333-7LB00-0AXO					6EP1332-5BA20			
	4 A							6EP3333-6SB00-0AYO	6EP1332-5BA10			
	5 A		6EP1333-3BA10 6EP3333-8SB00-0AYO	6EP3333-7SB00-0AXO 6EP3333-7SC00-0AXO	6EP1333-2BA20	6EP3333-3SB00-0AXO			6ES7307-1EA01-0AA0 6ES7307-1EA80-0AA0		6EP1333-1AL12 6EP1333-7CA10	
	6.25 A										6EP3343-0SA00-0AYO	
	8 A									6EP1333-4BA00	6EP1333-1LD01 6EP1334-7CA10	
	10 A		6EP1334-3BA10 6EP3334-8SB00-0AYO	6EP3334-7SB00-3AXO 6EP3334-7SC00-3AXO	6EP1334-2BA20 6EP1334-2AA01-0AB0	6EP3334-3SB00-0AXO			6ES7307-1KA02-0AA0 6EP7133-6AB00-0BNO		6EP1334-1AL12 6EP3343-0SA00-0AYO 6EP1334-1LD01	
	14.6 A											
	20 A			6EP1336-3BA10	6EP3336-7SB00-3AXO	6EP1336-2BA10	6EP3336-3SB00-0AXO					
	20 A/4 x 5 A	6EP3336-8MB00-2CYO										
	40 A			6EP3337-8SB00-0AYO								
	3-phase 400–500 V AC	5 A		6EP1333-3BA10 ¹⁾	6EP3433-7SB00-0AXO	6EP1433-2BA20						6EP1433-0AA00 6ES7148-4PC00-0HA0
		8 A								6ES7148-4PC00-0HA0		
		10 A		6EP1334-3BA10 ¹⁾	6EP3434-7SB00-3AXO	6EP1434-2BA20	6EP3434-3SB00-0AXO					
17 A										6EP3436-8UB00-0AYO		
20 A			6EP3436-8SB00-0AYO	6EP3436-7SB00-3AXO	6EP1436-2BA10	6EP3436-3SB00-0AXO						
20 A/4 x 5 A		6EP3436-8MB00-2CYO										
30 A												
40 A		6EP3437-8SB00-2AYO	6EP3437-8SB00-0AYO	6EP3437-7SB00-3AXO	6EP1437-2BA20					6EP3437-8UB00-0AYO 6EP3437-8UB00-0AYO		
40 A/4 x 10 A	6EP3437-8MB00-2CYO											
12 V DC	4 A									6EP3133-0TA10-0AYO		
24–110 V DC	2 A								6ES7305-1BA80-0AA0			
24 V DC	5 A									6EP3133-0TA00-0AYO 6EP3134-0TA00-0AYO		
	10 A									6EP3233-0TA10-0AYO 6EP3233-0TA00-0AYO 6EP3234-0TA00-0AYO		
48 V DC	3.5 A											
	5 A											
	10 A											
24–240 V DC (PSU3400) 110–300 V DC (LOGO!Power) 110–240 V DC / 120–240 V DC (PSU6200)	0.6 A							6EP3330-6SB00-0AYO	6EP1331-5BA00			
	1.3 A			6EP3331-7SB00-0AXO				6EP3331-6SB00-0AYO	6EP1331-5BA10			
	2.5 A			6EP3332-7SB00-0AXO				6EP3332-6SB00-0AYO	6EP1332-5BA00	6EP3332-0TA00-0AYO		
	3.7 A			6EP3333-7LB00-0AXO					6EP1332-5BA20			
	4 A							6EP3333-6SB00-0AYO	6EP1332-5BA10			
	5 A			6EP3333-7SB00-0AXO								
110–220 V DC	10 A			6EP3334-7SB00-3AXO								
	20 A			6EP3336-7SB00-3AXO								
	20 A/4 x 5 A	6EP3336-8MB00-2CYO										
88–350 V DC	20 A		6EP1336-3BA10									
600 V DC	20 A									6EP1536-3AA00		

¹⁾ Connection to two phases 230–500 V AC – sheet 24/25, SITOP PSU200M 1-/2-phase
Gray: more information in the Industry Mall

Input voltage	Output current	Advanced power supplies		Standard power supplies		Basic power supplies		SITOP DC/DC converter Special	Special designs and applications
		SITOP PSU8600	SITOP PSU8200	SITOP PSU6200	SITOP smart	LOGO!Power	SITOP compact		
Output voltage 5, 12, 15, 48, etc... V DC									
1-phase 120 V, 230 V AC	4–28 V/ 4 x 5 A	6EP3336-8SB00-2CY0							
	5 V/3 A						6EP3310-6SB00-0AY0		
	5 V/6.3 A						6EP3311-6SB00-0AY0		
	12 V/0.9 A						6EP3320-6SB00-0AY0		
	12 V/1.9 A						6EP3321-6SB00-0AY0		
	12 V/2.0 A			6EP3321-7SB00-0AX0				6EP1321-5BA00	
	12 V/3.0 A								6EP1321-1LD01
	12 V/4.5 A						6EP3322-6SB00-0AY0		
	12 V/6.5 A							6EP1322-5BA10	
	12 V/7 A			6EP3323-7SB00-0AX0	6EP1322-2BA00				
	12 V/8.5 A								6EP1322-1LD01
	12 V/12 A			6EP3324-7SB00-3AX0					
	12 V/14 A				6EP1323-2BA00				
	15 V/1.9 A						6EP3321-6SB10-0AY0		
	15 V/4 A						6EP3322-6SB10-0AY0		
	48 V/5 A			6EP3344-7SB00-3AX0					6EP3344-0SB00-0AY0
	48 V/10 A			6EP3346-7SB00-3AX0					
	3–52 V/ 2–10 A								6EP3343-0SA00-0AY0
2 x 15 V/ 3.5 A								6EP3323-0SA00-0BY0	
24 V DC	12 V/8 A							6EP3123-0TA00-0AY0	
	12 V/15 A							6EP3124-0TA00-0AY0	
3-phase 400–500 V AC	4–28 V/20 A	6EP3436-8SB00-2CY0							
	4–28 V/ 4 x 5 A	6EP3436-8MB00-2CY0							
	4–28 V/ 40 A	6EP3437-8SB00-2CY0							
	4–28 V/ 4 x 10 A	6EP3437-8MB00-2CY0							
		6EP3437-8MB10-2CY0							
	12 V/20 A								6EP3424-8UB00-0AY0
	36 V/13 A		6EP3446-8SB10-0AY0						
	48 V/5 A			6EP3444-7SB00-3AX0					
	48 V/10 A		6EP3446-8SB00-0AY0	6EP3446-7SB00-3AX0					
48 V/20 A		6EP3447-8SB00-0AY0	6EP3447-7SB00-3AX0						

SITOP PSU8600 advanced power supplies

The power supply system for digitalization and industry 4.0



Technical data	SITOP PSU8600 1- and 2-phase ¹⁾ , basic unit, 4 outputs	SITOP PSU8600 3-phase basic unit, 1 output	SITOP PSU8600 3-phase basic unit, 4 outputs	SITOP PSU8600 3-phase basic unit, 4 outputs	SITOP PSU8600 3-phase basic unit, 4 outputs
Output voltage/current, type	24 V/20 A/4x5 A, PSU8600	24 V/20 A, PSU8600	24 V/40 A, PSU8600	24 V/20 A/4x5 A, PSU8600	24 V/40 A/4x10 A, PSU8600
Article No. with PROFINET interface	6EP3336-8MB00-2CY0	6EP3436-8SB00-2AY0	6EP3437-8SB00-2AY0	6EP3436-8MB00-2CY0	6EP3437-8MB00-2CY0
Article No. with EtherNet/IP interface					6EP3437-8MB10-2CY0
Rated input voltage	100–240 V AC, 110–220 V DC	400–500 V 3 AC	400–500 V 3 AC	400–500 V 3 AC	400–500 V 3 AC
– Range	85...275 V AC, 93...275 V DC	320...575 V 3 AC	320...575 V 3 AC	320...575 V 3 AC	320...575 V 3 AC
Mains buffering	> 20 ms (at 100 V), extendable via buffer module or UPS module	> 15 ms (at 400 V), extendable via buffer modules and UPS module			
Rated line frequency	50/60 Hz	50/60 Hz	50/60 Hz	50/60 Hz	50/60 Hz
Rated input current	5.4–2.4 A, 4.8–2.4 A	1.4–1.1 A	2.75–2.2 A	1.4–1.1 A	2.75–2.2 A
– Inrush current	< 15 A	< 14 A	< 14 A	< 14 A	< 14 A
– Recommended protection. See also FAQ	10–32 A character C or time-lag fuses	6–16 A charact. C 3-ph. coupled or 3RV2011-1DA10 (setting 3 A) or 3RV2711-1DD10			
Rated output voltage	24 V DC	24 V DC	24 V DC	24 V DC	24 V DC
– Tolerance	± 3%	± 3%	± 3%	± 3%	± 3%
– Setting range	4...28 V DC	4...28 V DC	4...28 V DC	4...28 V DC	4...28 V DC
– Rated output current	20 A, 4 outputs each with 5 A, number expandable via CNX modules	20 A, one output, number can be increased via CNX module	40 A, one output, number can be increased via CNX module	20 A, four outputs at 5 A each, number can be increased via CNX module	40 A, four outputs at 10 A each, number can be increased via CNX module
– Overload behavior (Extra Power)	30 A for 5 s/min	30 A for 5 s/min	60 A for 5 s/min	30 A for 5 s/min	60 A for 5 s/min
– Derating	–	From +50 °C (2.5%/K); no derating in connection with expansion module and total load of basic devices' output up to 240 W (20-A devices) or up to 480 W (40-A devices)			
Switching threshold adjustment range	0.5...5 A	2...20 A	4...40 A	0.5...5 A	0.5...10 A
Shutdown behavior per output	Load current 101...149 % of the setting: shutdown after 5 s; load current >150 % of the setting: Current limitation and shutdown after 200 ms				
Efficiency at rated values, approx.	92%	93%	94%	93%	94%
Signaling contact "DC o. k."	Yes	Yes	Yes	Yes	Yes
Interface	Industrial Ethernet/PROFINET with two ports				
Parallel switching	Yes, output 1 with 2 or 3 with 4	Yes	Yes	Yes, output 1 with 2 or 3 with 4	
EMF suppression (EN 55022)	Class B	Class B	Class B	Class B	Class B
Line harmonics limitation (EN 61000-3-2)	Yes	Yes	Yes	Yes	Yes
Degree of protection (EN 60529)	IP 20	IP20	IP20	IP20	IP20
Ambient temperature	–25...+60 °C	–25...+60 °C	–25...+60 °C	–25...+60 °C	–25...+60 °C
Dimensions (W x H x D) in mm	125 x 125 x 150	80 x 125 x 150	125 x 125 x 150	100 x 125 x 150	125 x 125 x 150
Weight approx.	2.65 kg	1.8 kg	2.65 kg	2.0 kg	2.65 kg
Certification	CE, cULus, CB, cCSAus, ABS	CE, cULus, CB, cCSAus, SEMI F47, DNV, ABS			
System expandability	Up to 4 expansion modules (CNX8600) and up to 2 buffer components (BUF8600, UPS8600)				



Technical data	Expansion module		
Output current, typ	4 x 5 A, CNX8600	4 x 10 A, CNX8600	8 x 2.5 A, CNX8600
Article No.	6EP4436-8XB00-0CY0	6EP4437-8XB00-0CY0	6EP4436-8XB00-0DY0
Product/function description	Expansion module for PSU8600 basic devices for distribution of the direct current to other load circuits and monitoring for overload; selective switch-off of defective circuits, switching threshold individually configurable; a total of four modules can be used in a group of systems; data and power are transmitted via the System Clip Link connector		
Rated output voltage	24 V DC	24 V DC	24 V DC
– Tolerance	± 3 %	± 3 %	± 3 %
– Setting range	4...28 V DC	4...28 V DC	4...28 V DC
Rated output current	20 A/4 outputs of 5 A each	40 A/4 outputs of 10 A each	20 A/8 outputs of 2.5 A each
	Comment: The max. output capacity of the overall PSU8600 system cannot be increased via expansion modules		
– Switching threshold adjustment range	0.5...5 A	0.5...10 A	0.5...2.5 A
– Shutdown behavior per output	Load current 101...149 % of the setting: shutdown after 5 s; load current >150 % of the setting: Current limitation and shutdown after 200 ms		
Degree of protection (EN 60529)	IP 20	IP 20	IP 20
Ambient temperature	–25...+60 °C	–25...+60 °C	–25...+60 °C
Dimensions (W x H x D) in mm	60 x 125 x 150	60 x 125 x 150	100 x 125 x 150
Weight approx.	1.15 kg	1.15 kg	1.29 kg
Certification	CE, cULus, CB, cCSAus, SEMI F47, DNV, ABS, NEC Class 2 for 6EP4436-8XB00-0DY0 only		

¹⁾ 2-phase connection to 240 V, e.g. in North America

Specifications at rated input voltage and ambient temperature at +25 °C (unless otherwise specified)

SITOP PSU8600 advanced power supplies

The power supply system for digitalization and industry 4.0

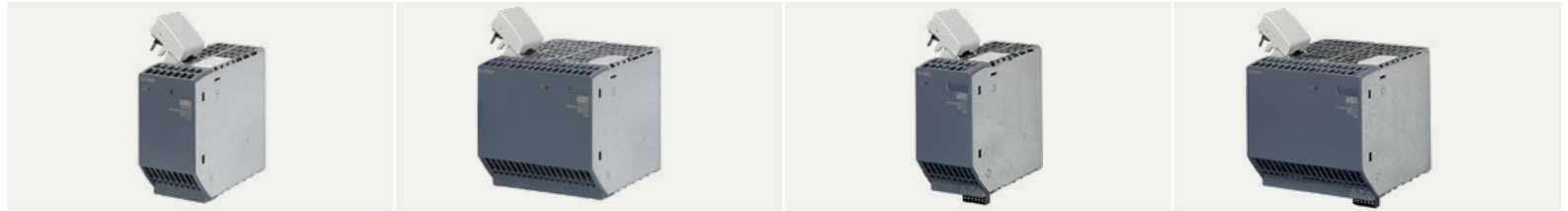

Technical data	Buffer module			
	100 ms/40 A, BUF8600	300 ms/40 A, BUF8600	4 s/40 A, BUF8600	10 s/40 A, BUF8600
Article No.	6EP4297-8HB00-OXY0	6EP4297-8HB10-OXY0	6EP4293-8HB00-OXY0	6EP4295-8HB00-OXY0
Product/function description	Expansion module for PSU8600 basic devices to extend buffering time during power failures. A total of two buffer components (BUF8600, UPS8600) can be used in a group of systems. Data and power are transmitted via the System Clip Link connector.			
Internal energy storage	Electrolytic capacitors		Double-layer capacitors (Ultracaps)	
Buffer time with 24 V DC and load current				
5 A	800 ms	2,4 s	40 s	80 s
10 A	400 ms	1,2 s	20 s	40 s
20 A	200 ms	600 ms	10 s	20 s
40 A	100 ms	300 ms	4 s	10 s
Typical charging time	19 s	54 s	5 min	10 min
Max. power during buffer operation	60 A for 5 s/min	60 A for 5 s/min	40 A	60 A for 5 s/min
Status messages via 3-color LED	Normal operation, state of charge, buffer operation, error		Normal operation, state of charge, buffer operation, error	
Status messages via signal contact	-		State of charge > x %, buffer operation	
Status messages via PROFINET (basic unit)	Normal operation, state of charge, buffer operation, error		Normal operation, state of charge, buffer operation, error	
Additional functions	-		Remote on/off contact for deactivating buffering, e.g., when shutting down the plant to prevent unnecessary discharge	
Degree of protection (EN 60529)	IP 20	IP 20	IP 20	IP 20
Ambient temperature	-25...+60 °C	-25...+60 °C	-25...+60 °C	-25...+60 °C
Dimensions (W x H x D) in mm	60 x 125 x 150	125 x 125 x 150	60 x 125 x 150	125 x 125 x 150
Weight approx.	1.33 kg	2.26 kg	1.25 kg	1.95 kg
Certification	CE, cULus, CB, cCSAus, SEMI F47, DNV, ABS		CE, cULus, CB, cCSAus, SEMI F47, DNV, ABS	

Specifications at rated input voltage and ambient temperature at +25 °C (unless otherwise specified)



Technical data	UPS module
Typ	UPS8600
Article No.	6EP4197-8AB00-OXYO
Product/function description	Expansion module for PSU8600 basic devices to bridge power failures with BAT8600 external battery modules. A total of two buffer components (BUF8600, UPS8600) can be used in a group of systems. Data and power are transmitted via the System Clip Link connector.
External energy storage	Battery module BAT8600
Buffer output	960 W
Charge power	120 W, 60 W (switchable)
Status messages via 3-color LED	Normal operation, battery status, buffer operation, error
Status messages via signal contact	State of charge > x%, buffer operation, battery circuit error
Status messages via I/PROFINET (basic unit)	Normal operation, battery status, buffer operation, error
Additional functions	Maximum buffer time, remote ON/OFF, start from battery
Degree of protection (EN 60529)	IP 20
Ambient temperature	-25...+70 °C
Installation	DIN rail
Dimensions (B x H x T) in mm	60 x 125 x 150
Weight approx.	1.2 kg
Certification	CE, cULus, CB, cCSAus, DNV, ABS

Specifications at rated input voltage and ambient temperature at +25 °C (unless otherwise specified)



Technical data	Battery module	
Typ	BAT8600 Pb	BAT8600 LiFePO4
Article No.	6EP4145-8GB00-OXYO	6EP4143-8JB00-OXYO
Product/function description	External energy storage device for UPS module UPS8600. Connection to the UPS module via plus and minus lines for power transmission as well as via the "Energy Storage Link" for data transmission. The Energy Storage Link enables diagnosis and temperature-controlled charging for maximum battery service life. Up to five identical battery modules can be connected to one UPS module.	
Battery/storage technology	Lead (Pb)	Lithium iron phosphate (LiFePO4)
Energy content	380 Wh	264 Wh
Rated voltage	48 V DC	48 V DC
Voltage range	42–58 V	42–58 V
Status messages via 3-color LED	State of charge, battery test/capacity test, battery replacement, overtemperature, error	
Overload and short-circuit protection	Blade fuse 40 A/58 V	Blade fuse 40 A/58 V
Parallel switching	yes, up to five (identical) units	yes, up to five (identical) units
Degree of protection (EN 60529)	IP 20	IP 20
Ambient temperature	-10...+50 °C	-10...+50 °C
Installation	Wall mounting	Wall mounting
Dimensions (B x H x T) in mm	322 x 187 x 110	322 x 187 x 110
Weight approx.	13.5 kg	6.5 kg
Certification	CE, UR, CB, cCSAus, DNV, ABS	CE, CB, cCSAus, DNV, ABS



System output capacity	Buffer times ¹⁾	
	120 W	2 h 4 min
240 W	57 min	60 min
480 W	25 min	29 min
720 W	14 min	22 min
960 W	10 min	14 min
Charging capacity	Charging times	
120 W/60 W (switchable)	2 h 45 min (120 W)	2 h 40 min (120 W)
Ambient temperature	Service life ²⁾	
+ 20 °C	4 years	15 years
+ 30 °C	2 years	10 years
+ 40 °C	1 year	9 years
+ 50 °C	0.5 years	2 years

1) Typical buffer times for a new fully-charged battery module at 25° C

2) Typical end of service life according to EUROBAT: reduction to 80% of original capacity

SITOP PSU8200 advanced power supplies

Technology power supply for demanding applications



Technical data	SITOP PSU8200 1-phase				SITOP PSU200M 1-phase/2-phase ²⁾
Output voltage/current, type	24 V/5 A, PSU8200	24 V/10 A, PSU8200	24V/20 A, PSU8200	24 V/40 A, PSU8200	24 V/5 A, PSU200M
Article No.	6EP3333-8SB00-0AY0	6EP3334-8SB00-0AY0	6EP1336-3BA10	6EP3337-8SB00-0AY0	6EP1333-3BA10
Article No. Ex version				6EP3337-8SC00-0AY0	
Rated input voltage – Range	120–230 V AC 85...132/170...264 V AC, automatic range switching		120–230 V AC, 110-220 V DC 85...275 V AC or 88...350 V DC	120/230 V AC 85...132/170...264 V AC, automatic range switching	120–230/230–500 V AC 85...264/176...550 V AC
Mains buffering	> 35 ms (at 120/230 V)	> 35 ms (at 120/230 V)	> 20 ms (at 120/230 V)	> 25 ms (at 230 V)	> 25 ms (at 120/230 V)
Rated line frequency	50/60 Hz	50/60 Hz	50/60 Hz	50/60 Hz	50/60 Hz
Rated input current – Inrush current ¹⁾ – Recommended miniature circuit breaker. See also FAQ	2.1/1.2 A < 10 A 6 A charact. C or 3RV2021-1xA10	4/1.9 A < 10 A 10 A charact. C or 3RV2021-1xA10	4.6–2.5 A < 20 A 10 A charact. C or 3RV2021-1xA10	15.0/8.0 A < 50 A 20 A charact. C or 3RV2411-xxA10	2.2–1.2/1.2–0.61 A < 35 A 6 A charact. C or 3RV2011-1xA10
Rated output voltage – Tolerance – Setting range	24 V DC ± 3 % 24...28.8 V DC	24 V DC ± 3 % 24...28.8 V DC	24 V DC ± 3 % 24...28.8 V DC	24 V DC ± 3 % 24...28.8 V DC	24 V DC ± 3 % 24...28.8 V DC
Rated output current – Overload behavior (power boost for 25 ms)	5 A 15 A	10 A 30 A	20 A 60 A	40 A 120 A	5 A 15 A
– Overload behavior (extra power for 5 s/min)	7.5 A	15 A	30 A	60 A	No
– Derating	No	from +60 °C (2%/K)	from +60 °C (3%/K)	from +60 °C (2.5%/K)	from +60 °C (3%/K)
Efficiency at rated values, approx.	93 %	94 %	94 %	92 %	88 %
Signaling contact "DC o. k."	Yes	Yes	Yes	Yes	Yes
Remote On/Off	Yes	Yes	Yes	No	No
Parallel switching	Yes, output characteristic can be switched to parallel operation				
Electronic short-circuit protection	Yes, constant current or latching shutdown selectable; constant current: approx. 1.15 x rated output current				
EMF suppression (EN 55022)	Class B	Class B	Class B	Class B	Class B
Line harmonics limitation	Yes (EN 61000-3-2)	Yes (EN 61000-3-2)	Yes (EN 61000-3-2)	Yes (EN 61000-3-2)	Yes (EN 61000-3-2)
Degree of protection (EN 60529)	IP20	IP20	IP20	IP20	IP20
Ambient temperature	–25...+70 °C	–25...+70 °C	–25...+70 °C	–25...+70 °C	–25...+70 °C
Dimensions (W x H x D) in mm	45 x 125 x 125	55 x 125 x 125	90 x 125 x 125	145 x 145 x 150	70 x 125 x 121
Weight approx.	0.8 kg	1 kg	1.2 kg	3.1 kg	0.6 kg
Certification	CE, cULus, CB, SEMI F47 ³⁾ , DNV, ABS		CE, cULus, DNV, ABS, BIS	CE, cULus, CB, SEMI F47 ⁴⁾ , DNV, ABS, Ex version: ATEX, IECEx, UKEx, Class I Div 2, CCC	CE, cULus, CB, SEMI F47 ³⁾ , DNV, ABS

¹⁾ Inrush current can be limited using a SITOP inrush current limiter: [6EP4683-6LB00-0AY0](#) (max. 5 A, 100-240 V AC) or [6EP1967-2AA00](#) (max. 10 A, 100-480 V AC, 1 unit per phase required).

²⁾ Connection to two phases of a three-phase supply network ³⁾ For input voltage 208-230 V AC ⁴⁾ In connection with two buffer modules
Specifications at rated input voltage and ambient temperature +25 °C (unless otherwise specified).



Technical data	SITOP PSU200M 1-phase/2-phase ²⁾	SITOP PSU8200 3-phase			SITOP PSU8200 3-phase, 36 V	SITOP PSU8200 3-phase, 48 V	
Output voltage/current, type	24 V/10 A, PSU200M	24 V/20 A, PSU8200	24 V/40 A, PSU8200	36 V/13 A, PSU8200	48 V/10 A, PSU8200	48 V/20 A, PSU8200	
Article No.	6EP1334-3BA10	6EP3436-8SB00-0AY0	6EP3437-8SB00-0AY0	6EP3446-8SB10-0AY0	6EP3446-8SB00-0AY0	6EP3447-8SB00-0AY0	
Rated input voltage – Range	120–230/230–500 V AC 85...264/176...550 V AC	400–500 V 3 AC 320...575 V 3 AC	400–500 V 3 AC 320...575 V 3 AC	400–500 V 3 AC 320...575 V 3 AC	400–500 V 3 AC 320...575 V 3 AC	400–500 V 3 AC 320...575 V 3 AC	400–500 V 3 AC 320...575 V 3 AC
Mains buffering	> 25 ms (at 120/230 V)	> 15 ms (at 400 V)	> 10 ms (at 400 V)	> 15 ms (at 400 V)	> 15 ms (at 400 V)	> 15 ms (at 400 V)	> 10 ms (at 400 V)
Rated line frequency	50/60 Hz	50/60 Hz	50/60 Hz	50/60 Hz	50/60 Hz	50/60 Hz	50/60 Hz
Rated input current – Inrush current ¹⁾ – Recommended miniature circuit breaker. See also FAQ	4.4–2.4/2.4–1.1 A < 35 A 6 A charact. C or 3RV2011-1xA10	1.2–1.0 A < 18 A 6–16 A charact. C 3-ph. coupled or 3RV2011-1DA10 or 3RV2711-1DD10	2.1–1.7 A < 13 A 10–16 A charact. C 3-ph. coupled or 3RV2011-1DA10 or 3RV2711-1DD10	1.2–1.0 A < 18 A 6–16 A charact. C 3-ph. coupled or 3RV2011-1DA10 or 3RV2711-1DD10	1.2–1.0 A < 18 A 6–16 A charact. C 3-ph. coupled or 3RV2011-1DA10 or 3RV2711-1DD10	1.2–1.0 A < 13 A 10–16 A charact. C 3-ph. coupled or 3RV2011-1DA10 or 3RV2711-1DD10	2–1.7 A < 13 A 10–16 A charact. C 3-ph. coupled or 3RV2011-1DA10 or 3RV2711-1DD10
Rated output voltage – Tolerance – Setting range	24 V DC ± 3 % 24...28.8 V DC	24 V DC ± 3 % 24...28.8 V DC	24 V DC ± 3 % 24...28 V DC	36 V DC ± 3 % 36...40 V DC	48 V DC ± 3 % 42...56 V DC	48 V DC ± 3 % 46...56 V DC	48 V DC ± 3 % 46...56 V DC
Rated output current	10 A	20 A	40 A	13 A	10 A	20 A	
– Overload behavior (power boost for 25 ms)	30 A	60 A	120 A	39 A	23 A	60 A	
– Overload behavior (extra power for 5 s/min)	No	30 A	60 A	19.5 A	15 A	30 A	
– Derating	from +60 °C (3%/K)	from +60 °C (3%/K)	from +60 °C (4%/K)	from +60 °C (3%/K)	from +60 °C (3%/K)	from +60 °C (4%/K)	
Efficiency at rated values, approx.	91 %	94 %	94 %	94 %	93 %	94 %	
Signaling contact "DC o. k."	Yes	Yes	Yes	Yes	Yes	Yes	
Remote On/Off	No	Yes	Yes	Yes	Yes	Yes	
Parallel switching	Yes, output characteristic can be switched to parallel operation						
Electronic short-circuit protection	Yes, constant current or latching shutdown selectable; constant current: approx. 1.15 x rated output current						
EMF suppression (EN 55022)	Class B	Class B	Class B	Class B	Class B	Class B	
Line harmonics limitation	Yes (EN 61000-3-2)	Yes (EN 61000-3-2)	Yes (EN 61000-3-2)	Yes (EN 61000-3-2)	Yes (EN 61000-3-2)	Yes (EN 61000-3-2)	
Degree of protection (EN 60529)	IP20	IP20	IP20	IP20	IP20	IP20	
Ambient temperature	–25...+70 °C	–25...+70 °C	–25...+70 °C	–10...+70 °C	–25...+70 °C	–25...+70 °C	
Dimensions (W x H x D) in mm	70 x 125 x 121	70 x 125 x 125	135 x 145 x 150	70 x 125 x 125	70 x 125 x 125	135 x 145 x 150	
Weight approx.	1.4 kg	1.2 kg	3.3 kg	1.2 kg	1.2 kg	3.3 kg	
Certification	CE, cULus, CB, SEMI F47 ³⁾ , DNV, ABS			CE, cULus, CB	CE, cULus, CB, DNV, ABS	CE, cULus, CB, SEMI F47	

SITOP PSU6200 standard power supplies

The all-around power supply for a wide range of applications



Technical data	SITOP PSU6200 1-phase					
Output voltage/current, type	12 V/2 A, PSU6200	24 V/1,3 A, PSU6200	24 V/2.5 A, PSU6200	12 V/7 A, PSU6200	24 V/3,7 A, PSU6200	24 V/5 A, PSU6200
Article No.	6EP3321-7SB00-0AX0	6EP3331-7SB00-0AX0	6EP3332-7SB00-0AX0	6EP3323-7SB00-0AX0	6EP3333-7LB00-0AX0	6EP3333-7SB00-0AX0
Article No. Ex version						6EP3333-7SC00-0AX0
Rated input voltage	120–230 V AC/120–240 V DC			120–230 V AC/120–240 V DC		
– Range	85...264 V AC/110...275 V DC			85...264 V AC/99...275 V DC		
Mains buffering	150 ms at U _{in} = 230 V	150 ms at U _{in} = 230 V	150 ms at U _{in} = 230 V	90 ms at U _{in} = 230 V	90 ms at U _{in} = 230 V	80 ms at U _{in} = 230 V
Rated line frequency	50/60 Hz	50/60 Hz	50/60 Hz	50/60 Hz	50/60 Hz	50/60 Hz
Rated input current	0.5/0.3 A	0.6/0.3 A	1.1/0.6 A	1.4/0.8 A	1.5/0.9 A	1.9/1.1 A
– Inrush current ¹⁾	< 32 A	< 32 A	< 32 A	< 29 A	< 29 A	< 29 A
– Recommended miniature circuit breaker. See also FAQ	from 4 A characteristic C	from 4 A characteristic C	from 4 A characteristic C	from 6 A characteristic C	from 6 A characteristic C	from 6 A characteristic C
Rated output voltage	12 V	24 V	24 V	12 V	24 V	24 V
– Tolerance	± 3%	± 3%	± 3%	± 3%	± 3%	± 3%
– Setting range	10.5...12.9 V	22.2...26.4 V	22.2...26.4 V	12...15.5 V	24...28 V	24...28 V
Rated output current	2 A	1.3 A	2.5 A	7 A	3.7 A	5 A
– Permanently up to +45 °C	2 A	1,3 A	2.5 A	8.4 A	3.7 A	6 A
– Overload behavior (extra power for 5 s/min)	–	–	–	150%	–	150%
– Derating	–	from +60 °C (2.5%/K)	from +60 °C (1.5%/K)	from +60 °C (2%/K)	–	from +60 °C (2%/K)
Efficiency at rated values, approx.	83.3%	86.3%	89%	87.1%	89.3%	90.2%
Signaling contact	No	No	No	DC o.k.	DC o.k.	DC o.k.
Parallel switching	No	No	No	No	No	No
Electronic short-circuit protection	Yes, restart	Yes, restart	Yes, restart	Yes, constant current (< 9 V hiccup)	Yes, constant current (< 15 V hiccup)	Yes, constant current (< 15 V hiccup)
EMF suppression (EN 55022)	Class B	Class B	Class B	Class B	Class B	Class B
Line harmonics limitation (EN 61000-3-2)	Not applicable	Not applicable	Not applicable	Yes	Yes	Yes
Degree of protection (EN 60529)	IP 20	IP 20	IP 20	IP 20	IP 20	IP 20
Ambient temperature	Operation –25...+70 °C			Operation –30 ... +70 °C, startup from –40°C		
Dimensions (W x H x D) in mm	25 x 100 x 88	25 x 100 x 88	40 x 100 x 88	35 x 135 x 125	35 x 135 x 125	35 x 135 x 125
Weight approx.	0.2 kg	0.2 kg	0.25 kg	0.7 kg	0.7 kg	0.7 kg
Certification	CE, cULus, cCSAus, CB, SEMI F47, BIS, ABS. NEC Class 2 : 12 V/2 A, 24 V/1.3 A; 2.5 A; 3.7 A. ATEX, IECEx, UKEx, Class I Div 2, CCC: 6EP3333-7SC00-0AX0. In preparation: DNV, ABS					

¹⁾ Inrush current can be limited using a SITOP inrush current limiter: Article no. [6EP4683-6LB00-0AY0](#) (max. 5 A, 100-240 V AC)
Specifications at rated input voltage and ambient temperature +25 °C (unless otherwise specified)



SITOP PSU6200 1-phase

12 V/12 A, PSU6200	24 V/10 A, PSU6200	48 V/5 A, PSU6200	24 V/20 A, PSU6200	48 V/10 A, PSU6200
6EP3324-7SB00-3AX0	6EP3334-7SB00-3AX0 6EP3334-7SC00-3AX0	6EP3344-7SB00-3AX0	6EP3336-7SB00-3AX0 6EP3336-7SC00-3AX0	6EP3346-7SB00-3AX0
120–230 V AC/110–240 V DC				
85...264 V AC/85...275 V DC				
70 ms at Uin = 230 V	45 ms at Uin = 230 V	46 ms at Uin = 230 V	25 ms at Uin = 230 V	25 ms at Uin = 230 V
50/60 Hz	50/60 Hz	50/60 Hz	50/60 Hz	50/60 Hz
1.4/0.8 A	2.2/1.2 A	2.2/1.2 A	4.3/2.3 A	4.3/2.3 A
< 6 A	< 6 A	< 6 A	< 12 A	< 12 A
from 6 A characteristic C	from 10 A characteristic C	from 10 A characteristic C	from 10 A characteristic C	from 10 A characteristic C
12 V	24 V	48 V	24 V	48 V
± 3%	± 3%	± 3%	± 3%	± 3%
12...15.5 V	24...28 V	48...56 V	24...28 V	48...56 V
12 A	10 A	5 A	20 A	10 A
14.4 A	12 A	6 A	24 A	12 A
150%	150%	150%	150%	150%
from +60 °C (2%/K)	from +60 °C (2%/K)	from +60 °C (3%/K)	from +60 °C (1%/K)	from +60 °C (3%/K)
89.3%	92.8%	93.9%	95.5%	95.8%
DC o.k./Diagnostics	DC o.k./Diagnostics	DC o.k./Diagnostics	DC o.k./Diagnostics	DC o.k./Diagnostics
Yes, 2 units	Yes, 2 units	Yes, 2 units	Yes, 2 units	Yes, 2 units
Yes, constant current (< 9 V hiccup)	Yes, constant current (< 15 V hiccup)	Yes, constant current (< 30 V hiccup)	Yes, constant current (< 15 V hiccup)	Yes, constant current (< 30 V hiccup)
Class B	Class B	Class B	Class B	Class B
Yes	Yes	Yes	Yes	Yes
IP 20	IP 20	IP 20	IP 20	IP 20
–25...+70 °C, startup from –40 °C	Operation –30 ... +70 °C, startup from –40 °C			
45 x 135 x 125	45 x 135 x 125	45 x 135 x 125	70 x 135 x 155	70 x 135 x 155
0.9 kg	0.9 kg	0.9 kg	1.5 kg	1.5 kg

CE, cULus, cCSAus, CB, SEMI F47, BIS, ABS, ATEX, IECEx, UKEx, Class I Div 2, CCC: 6EP3334-7SC00-0AX0, 6EP3336-7SC00-0AX0. Pending: DNV

SITOP PSU6200 standard power supplies

The all-around power supply for a wide range of applications



Technical data	SITOP PSU6200 3-phase						
Output voltage	24 V/5 A, PSU6200	24 V/10 A, PSU6200	48 V/5 A, PSU6200	24 V/20 A, PSU6200	48 V/10 A, PSU6200	24 V/40 A, PSU6200	48 V/20 A, PSU6200
Article No.	6EP3433-7SB00-0AX0	6EP3434-7SB00-3AX0	6EP3444-7SB00-3AX0	6EP3436-7SB00-3AX0	6EP3446-7SB00-3AX0	6EP3437-7SB00-3AX0	6EP3447-7SB00-3AX0
Article No. Ex version	6EP3433-7SC00-0AX0	6EP3434-7SC00-3AX0		6EP3436-7SC00-3AX0		6EP3437-7SC00-3AX0	
Rated input voltage	400–500 V 3 AC						
– Range	323 ... 576 V 3 AC/450...600 V DC						
Mains buffering	20 ms at U _{in} = 400 V	30 ms at U _{in} = 400 V	30 ms at U _{in} = 400 V	25 ms at U _{in} = 400 V	25 ms at U _{in} = 400 V	25 ms at U _{in} = 400 V	25 ms at U _{in} = 400 V
Rated line frequency	50/60 Hz	50/60 Hz	50/60 Hz	50/60 Hz	50/60 Hz	50/60 Hz	50/60 Hz
Rated input current	0.33/0.28 A	0.39/0.32 A	0.39/0.32 A	0.77/0.62 A	0.77/0.62 A	1.5/1.2 A	1.5/1.2 A
– Inrush current	< 22 A	< 13 A	< 13 A	< 17 A	< 17 A	< 10 A	< 10 A
– Recommended miniature circuit breaker. See also FAQ	4...10 A char. C 3-ph. coupled ¹⁾	4...16 A characteristic C 3-ph. coupled ¹⁾					
Rated output voltage	24 V	24 V	48 V	24 V	48 V	24 V	48 V
– Tolerance	± 3%	± 3%	± 3%	± 3%	± 3%	± 3%	± 3%
– Setting range	24...28 V	24...28 V	48...56 V	24...28 V	48...56 V	24...28 V	48...56 V
Rated output current	5 A	10 A	5 A	20 A	10 A	40 A	20 A
– Permanently up to +45 °C	6 A	12 A	6 A	24 A	12 A	48 A	24 A
– Overload behavior (extra power for 5 s/min)	150%	150%	150 %	150%	150 %	150 %	150 %
– Derating	from +60 °C (3%/K)	from +60 °C (3%/K)	from +60 °C (3%/K)	from +60 °C (3%/K)	from +60 °C (3%/K)	from +60 °C (3%/K)	from +60 °C (3%/K)
Efficiency at rated values, approx.	91.2%	95.4%	95.6%	95.9%	96.2%	96.0%	96.6%
Signaling contact	DC o.k.	DC o.k./Diagnostics	DC o.k./Diagnostics	DC o.k./Diagnostics	DC o.k./Diagnostics	DC o.k./Diagnostics	DC o.k./Diagnostics
Parallel switching	No	Yes, 2 units	Yes, 2 units	Yes, 2 units	Yes, 2 units	Yes, 2 units	Yes, 2 units
Electronic short-circuit protection	Yes, constant current (< 15 V hiccup)	Yes, constant current (< 15 V hiccup)	Yes, constant current (< 30 V hiccup)	Yes, constant current (< 15 V hiccup)	Yes, constant current (< 30 V hiccup)	Yes, constant current (< 15 V hiccup)	Yes, constant current (< 30 V hiccup)
EMF suppression (EN 55022)	Class B	Class B	Class B	Class B	Class B	Class B	Class B
Line harmonics limitation (EN 61000-3-2)	Yes	Yes	Yes	Yes	Yes	Yes	Yes
Degree of protection (EN 60529)	IP 20	IP 20	IP 20	IP 20	IP 20	IP 20	IP 20
Ambient temperature	Operation: –30 ...+ 70 °C, startup from –40 °C						
Dimensions (W x H x D) in mm	35 x 135 x 125	45 x 135 x 155	45 x 135 x 155	70 x 135 x 155	70 x 135 x 155	95 x 135 x 155	95 x 135 x 155
Weight approx.	0.7 kg	0.9 kg	0.9 kg	1.5 kg	1.5 kg	2.1 kg	2.1 kg
Certification	CE, cULus, SEMI F47, BIS, ABS. Ex version: ATEX, IECEx, Class I Div 2, CCC. Pending: DNV						

¹⁾ Or 3RV2011-1EA10 or 3RV2711-1ED10
Specifications at rated input voltage and ambient temperature +25 °C (unless otherwise specified)

SITOP smart standard power supplies

The high-performance standard power supply

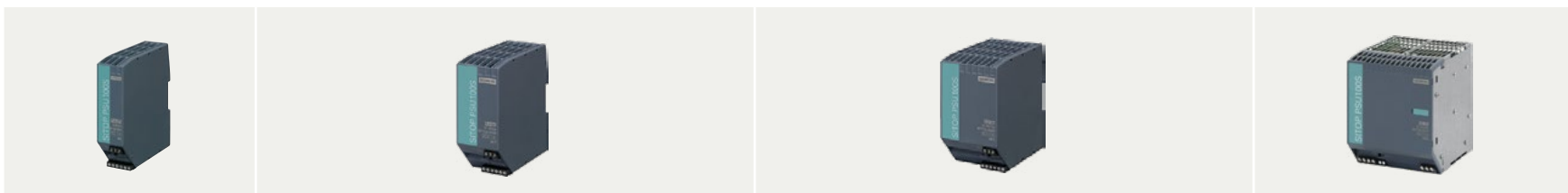

Technical data	SITOP smart 1-phase					
Output voltage/current. type	24 V/2.5 A, PSU100S	24 V/5 A, PSU100S	12 V 7A, PSU100S	24 V/10 A, PSU100S	12 V/14 A, PSU100S	24 V/20 A, PSU100S
Article No.	6EP1332-2BA20	6EP1333-2BA20	6EP1322-2BA00	6EP1334-2BA20	6EP1323-2BA00	6EP1336-2BA10
Rated input voltage	120/230 V AC	120/230 V AC	120/230 V AC	120/230 V AC	120/230 V AC	120/230 V AC
– Range	85...132/170...264 V AC, automatic range switching					
Mains buffering	> 20 ms (at 93/187 V)	> 20 ms (at 93/187 V)	> 20 ms (at 93/187 V)	> 20 ms (at 93/187 V)	> 20 ms (at 93/187 V)	> 20 ms (at 120/230 V)
Rated line frequency	50/60 Hz	50/60 Hz	50/60 Hz	50/60 Hz	50/60 Hz	50/60 Hz
Rated input current	1.25 A/0.74 A	2.34 A/1.36 A	1.73 A/0.99 A	4.49 A/1.91 A	3.24 A/1.41 A	7.5/3.5 A
– Inrush current ¹⁾	< 33 A	< 40 A	< 45 A	< 60 A	< 60 A	< 11 A
– Recommended miniature circuit breaker. See also FAQ	from 3 A characteristic C	from 6 A characteristic C	from 6 A characteristic C	from 10 A characteristic C	from 10 A characteristic C	from 10 A characteristic C
Rated output current	24 V DC	24 V DC	12 V DC	24 V DC	12 V DC	24 V DC
– Tolerance	± 3 %	± 3 %	± 3 %	± 3 %	± 3 %	± 3 %
– Setting range	22.8...28 V DCV	22.8...28 V DCV	11.5...15.5 V DC	22.8...28 V DC	11.5...15.5 V DC	24...28 V DC
Rated output current	2.5 A	5 A	7 A	10 A	14 A	20 A
– Permanently up to +45 °C	3 A	6 A	7 A	12 A	14 A	24 A
– Overload behavior (extra power for 5 s/min)	3.75 A	7.5 A	10.5 A	15 A	21 A	30 A
– Derating	from +60 °C (3%/K)	from +60 °C (3%/K)	from +55 °C (5%/K)	from +60 °C (3%/K)	from +55 °C (5%/K)	from +60 °C (5%/K)
Efficiency at rated values. approx.	85 %	88 %	84 %	90 %	87 %	90 %
Signaling contact "DC o. k."	Yes	Yes	Yes	Yes	Yes	Yes
Parallel switching	Yes	Yes	Yes	Yes	Yes	Yes
Elec. short-circuit protection	Yes, constant current	Yes, constant current	Yes, constant current	Yes, constant current	Yes, constant current	Yes, restart
EMF suppression (EN 55022)	Class B	Class B	Class B	Class B	Class B	Class B
Line harmonics limitation (EN 61000-3-2)	Not applicable	Yes	Yes	Yes	Yes	Yes
Degree of protection (EN 60529)	IP20	IP20	IP20	IP20	IP20	IP20
Ambient temperature	–25...+70 °C	–25...+70 °C	–25...+70 °C	–25...+70 °C	–25...+70 °C	–25 ...+70 °C
Dimensions (W x H x D) in mm	32.5 x 125 x 120	50 x 125 x 120	50 x 125 x 120	70 x 125 x 120	70 x 125 x 120	115 x 145 x 150
Weight approx.	0.32 kg	0.5 kg	0.5 kg	0.8 kg	0.8 kg	2.4 kg
Certification	CE, cULus, CB, DNV, BV					

¹⁾ Inrush current can be limited by means of a SITOP inrush current limiter: [6EP4683-6LB00-0AY0](#) (max. 5 A, 100 - 240 V AC) or [6EP1967-2AA00](#) (max. 10 A, 100 - 480 V AC, 1 unit per phase required)

Specifications at rated input voltage and ambient temperature +25 °C (unless otherwise specified)

SITOP smart standard power supplies

The high-performance standard power supply

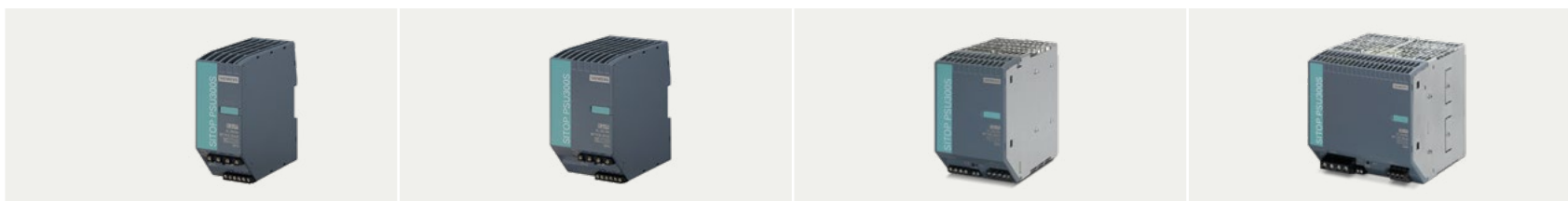

Technical data	SITOP smart 3-phase			
Output voltage/current. type	24 V/5 A, PSU300S	24 V/10 A, PSU300S	24 V/20 A, PSU300S	24 V/40 A, PSU300S
Article No.	6EP1433-2BA20	6EP1434-2BA20	6EP1436-2BA10	6EP1437-2BA20
Rated input voltage	400–500 V 3 AC	400–500 V 3 AC	400–500 V 3 AC	400–500 V 3 AC
– Range	340...550 V 3 AC	340...550 V 3 AC	340...550 V 3 AC	340...550 V 3 AC
Mains buffering	> 6 ms (at 400 V)	> 6 ms (at 400 V)	> 6 ms (at 400 V)	> 6 ms (at 400 V)
Rated line frequency	50/60 Hz	50/60 Hz	50/60 Hz	50/60 Hz
Rated input current	0.45–0.4 A	0.7–0.6 A	1.2–1.0 A	2.0–1.5 A
– Inrush current ¹⁾	< 40	< 50	< 36	< 60 A
– Recommended miniature circuit breaker. See also FAQ	A6–16 A charact. C 3-ph. coupled or 3 RV2711-1DD10	A 6–16 A charact. C 3-ph. coupled or 3 RV2711-1DD10	A 6–16 A charact. C 3-ph. coupled or 3 RV2711-1DD10	10–16 A charact. C 3-ph. coupled or 3 RV2711-1DD10
Rated output voltage	24 V DC	24 V DC	24 V DC	24 V DC
– Tolerance	± 3 %	± 3 %	± 3 %	± 3 %
– Setting range	24...28 V DC	24...28 V DC	24...28 V DC	24...28 V DC
Rated output current	5 A	10 A	20 A	40 A
– Permanently up to +45 °C	6 A	12 A	24 A	48 A
– Overload behavior (extra power for 5 s/min)	7.5 A	15 A	30 A	60 A
– Derating	from +60 °C (3%/K)	from +60 °C (3%/K)	from +60 °C (5%/K)	from +60 °C (2.5%/K)
Efficiency at rated values. approx.	89 %	91 %	91 %	91.5 %
Signaling contact "DC o. k."	Yes	Yes	Yes	Yes
Parallel switching	Yes	Yes	Yes	Yes
Electronic short-circuit protection	Yes, constant current	Yes, constant current	Yes, restart	Yes, restart
EMF suppression (EN 55022)	Class B	Class B	Class B	Class B
Line harmonics limitation (EN 61000-3-2)	Yes	Yes	Yes	Yes
Degree of protection (EN 60529)	IP20	IP20	IP20	IP20
Ambient temperature	–25...+70 °C	–25...+70 °C	0...+70 °C	0...+70 °C
Dimensions (W x H x D) in mm	50 x 125 x 120	70 x 125 x 120	90 x 145 x 150	150 x 145 x 150
Weight approx.	0.43 kg	0.67 kg	1.6 kg	3.7 kg
Certification	CE, cULus, CB, DNV, ABS			

¹⁾ Inrush current can be limited by means of a SITOP inrush current limiter: [6EP4683-6LB00-0AY0](#) (max. 5 A, 100 - 240 V AC) or [6EP1967-2AA00](#) (max. 10 A, 100 - 480 V AC, 1 unit per phase required)
Specifications at rated input voltage and ambient temperature +25 °C (unless otherwise specified)

SITOP PSU4200 basic power supplies

Fresh Power for basic applications



Technical data	SITOP PSU4200 1-phase				SITOP PSU4200 3-phase	
Output voltage/current, type	24 V/3 A, PSU4200	24 V/5 A, PSU4200	24 V/10 A, PSU4200	24 V/20 A, PSU4200	24 V/10 A, PSU4200	24 V/20 A, PSU4200
Article No.	6EP3332-3SB00-0AX0	6EP3333-3SB00-0AX0	6EP3334-3SB00-0AX0	6EP3336-3SB00-0AX0	6EP3434-3SB00-0AX0	6EP3436-3SB00-0AX0
Rated input voltage – Range	100 – 120 V AC / 200 – 240 V AC 85 – 132 V AC / 187 – 264 V AC (automatic range switching)			100 – 240 V AC 85 – 264 V AC (wide range)		400 – 500 V AC 320 – 550 V AC (wide range input)
Mains buffering	15 ms	15 ms	15 ms	15 ms	5 ms	5 ms
Rated line frequency	50/60 Hz	50/60 Hz	50/60 Hz	50/60 Hz	50/60 Hz	50/60 Hz
Rated input current – Inrush current ¹⁾	1.3 A/0.73 A < 45 A	2.1 A/1.25 A < 45 A	4.3 A/2.5 A < 60 A	4.5 A/2.4 A < 20 A	0.7 A/0.6 A < 50 A	1.4 A/1.2 A < 36 A
– Recommended miniature circuit breaker. See also FAQ	from 6 A characteristic C to 16 A characteristic C			from 10 A characteristic C to 16 A characteristic C		Three-poled coupled circuit breaker from 3 A characteristic C to 16 A characteristic C or circuit breaker 3RV2011-1EA10 (setting 3 A) or 3RV2711-1ED10 (UL 489)
Rated output voltage – Tolerance – Setting range	24 V DC ± 3% 24... 28 V DC	24 V DC ± 3% 24... 28 V DC	24 V DC ± 3% 24... 28 V DC	24 V DC ± 3% 24... 28 V DC	24 V DC ± 3% 24... 28 V DC	24 V DC ± 3% 24... 28 V DC
Rated output current – Derating	3 A from +60 °C (2.5 %/K)	5 A from +60 °C (2.5 %/K)	10 A from +60 °C (2.5 %/K)	20 A from +60 °C (2.5 %/K)	10 A from +60 °C (2.5 %/K)	20 A from +60 °C (2.5 %/K)
Efficiency at rated values, approx.	85%	87%	90%	93%	90%	91%
Status indicator	Green LED for DC OK (24 V) Yellow LED for I _{out} > 85%	Green LED for DC OK (24 V) Yellow LED for I _{out} > 85%	Green LED for DC OK (24 V) Yellow LED for I _{out} > 85%	Green LED for DC OK (24 V) Yellow LED for I _{out} > 85%	Green LED for DC OK (24 V) Yellow LED for I _{out} > 85%	Green LED for DC OK (24 V) Yellow LED for I _{out} > 85%
Signaling contact “DC o. k.”	No	Yes	Yes	Yes	Yes	Yes
Parallel switching	Yes	Yes	Yes	Yes	Yes	Yes
Electronic short-circuit protection	Yes, constant current	Yes, constant current	Yes, constant current	Yes, constant current (< 15 V hiccup)	Yes, constant current	Yes, constant current
EMF suppression (EN 55022)	Class A	Class A	Class A	Class A	Class A	Class A
Line harmonics limitation (EN 61000-3-2)	Yes	Yes	Yes	Yes	Yes	Yes
Degree of protection (EN 60529)	IP 20	IP 20	IP 20	IP 20	IP 20	IP 20
Ambient temperature	-25 up to +70 °C	-25 up to +70 °C	-25 up to +70 °C	-25 up to +70 °C	-25 up to +70 °C	-25 up to +70 °C
Dimensions (W x H x D) in mm	50 x 135 x 125	50 x 135 x 125	70 x 135 x 125	70 x 135 x 125	70 x 135 x 125	95 x 135 x 150
Weight approx.	0.44 kg	0.44 kg	0.65 kg	0.93 kg	0.64 kg	1.66 kg
Certification	CE, UKAC, CB, cULus, cCSAus, BIS, EAC, RCM					

¹⁾ Inrush current can be limited using a SITOP inrush current limiter: 6EP4683-6LB00-0AY0 (max. 5 A, 100-240 V AC) or 6EP1967-2AA00 (max. 10 A, 100-480 V AC, 1 unit per phase required). Specifications at rated input voltage and ambient temperature +25 °C (unless otherwise specified)

LOGO!Power basic power supplies

Flat power supply for distribution boards



Technical data	18-mm design		36-mm design			
Output voltage/current	12 V/0.9 A	24 V/0.6 A	5 V/3 A	12 V/1.9 A	15 V/1.9 A	24 V/1.3 A
NEC Class 2	Yes	Yes	Yes	Yes	Yes	Yes
Article No.	6EP3320-6SB00-0AY0	6EP3330-6SB00-0AY0	6EP3310-6SB00-0AY0	6EP3321-6SB00-0AY0	6EP3321-6SB10-0AY0	6EP3331-6SB00-0AY0
Article No. Ex version						
Rated input voltage – Range	100–240 V AC 85...264 V AC/110...300 V DC		100–240 V AC 85...264 V AC/110...300 V DC			
Mains buffering	> 40 ms (at 187 V)		> 40 ms (at 187 V)			
Rated line frequency	50/60 Hz		50/60 Hz			
Rated input current – Inrush current ¹⁾	0.3–0.2 A < 20 A	0.3–0.2 A < 20 A	0.36–0.22 A < 26 A	0.53–0.30 A < 25 A	0.63–0.33 A < 25 A	0.70–0.35 A < 25 A
– Recommended miniature circuit breaker. See also FAQ	from 6 A characteristic B or from 2 A characteristic C		from 6 A characteristic B or from 2 A characteristic C			
Rated output voltage – Tolerance – Setting range	12 V DC ± 3 % None	24 V DC ± 3 % None	5 V DC ± 3 % 4.6...5.4 V DC	12 V DC ± 3 % 10.5...16.1 V DC	DC 15 V ± 3 % 10.5...16.1 V DC	24 V DC ± 3 % 22.2...26.4 V DC
Rated output current – Overload behavior on startup – Derating	0.9 A 1.35 A (für 200 ms)	0.6 A 0.9 A (for 200 ms)	3.0 A 4.5 A (for 200 ms) from +55 °C (2 %/K)	1.9 A 2.85 A (for 200 ms) from +55 °C (2 %/K)	1.9 A 2.85 A (für 200 ms) from +55 °C (2 %/K)	1.3 A 1.95 A (für 200 ms) from +55 °C (2 %/K)
Efficiency at rated values, approx.	78 %	81 %	76 %	81 %	83 %	86 %
Signaling contact "DC o. k."	No		No	No	No	No
Parallel switching	No	No	Yes	Yes	Yes	Yes
No-load loss	< 0.3 W		< 0.3 W			
Electronic short-circuit protection	Yes, constant current		Yes, constant current			
EMF suppression (EN 55022)	Class B		Class B			
Line harmonics limitation (EN 61000-3-2)	Not applicable		Not applicable			
Degree of protection (EN 60529)	IP20		IP20			
Ambient temperature	–25... +70 °C		–25... +70 °C			
Dimensions (W x H x D) in mm	18 x 90 x 53		36 x 90 x 53			
Weight approx.	0.07 kg	0,07 kg	0.12 kg			
Certification	CE, CB Scheme, cULus, cURus, NEC Class 2, SEMI F47, DNV, ABS, EAC		CE, CB Scheme, cULus, cURus, NEC Class 2, SEMI F47, DNV, ABS, EAC		CE, CB Scheme, cULus, cURus, NEC Class 2, SEMI F47, DNV, ABS, EAC	

Specifications at rated input voltage and ambient temperature +25 °C (unless otherwise specified).

¹⁾ Inrush current can be limited using a SITOP LOGO! ICL 230 inrush current limiter: [6EP4683-6LB00-0AY0](#) (max. 5 A, 100-240 V AC)



Technical data	54-mm design				72-mm design
Output voltage/current	5 V/6,3 A	12 V/4,5 A	15 V/4 A	24 V/2.5 A	24 V/4 A
NEC Class 2	No	Yes	Yes	Yes	No
Article No.	6EP3311-6SB00-0AY0	6EP3322-6SB00-0AY0	6EP3322-6SB10-0AY0	6EP3332-6SB00-0AY0	6EP3333-6SB00-0AY0
Article No. Ex version					6EP3333-6SC00-0AY0
Rated input voltage – Range	100–240 V AC 85...264 V AC/110...300 V DC				100–240 V AC 85...264 V AC/110...300 V DC
Mains buffering	> 40 ms (at 187 V)				> 40 ms (at 187 V)
Rated line frequency	50/60 Hz				50/60 Hz
Rated input current – Inrush current ¹⁾	0.71–0.37 A < 50 A	1.13–0.61 A < 50 A	1.24–0.68 A < 55 A	1.22–0.66 A < 52 A	1.95–0.97 A < 31 A
– Recommended miniature circuit breaker. See also FAQ	from 10 A characteristic B or from 6 A characteristic C				from 10 A characteristic B or from 6 A characteristic C
Rated output voltage – Tolerance	5 V DC ± 3%	12 V DC ± 3%	15 V DC ± 3%	24 V DC ± 3%	24 V DC ± 3%
– Setting range	4.6...5.4 V DC	10.5...16.1 V DC	10.5...16.1 V DC	22.2...26.4 V DC	22.2...26.4 V DC
Rated output current – Overload behavior on startup – Derating	6.3 A 9.45 A (for 200 ms) from +55 °C (2 %/K)	4.5 A 6.75 A (for 200 ms) from +55 °C (2 %/K)	4.0 A 6.0 A (for 200 ms) from +55 °C (2 %/K)	2.5 A 3.75 A (for 200 ms) from +55 °C (2 %/K)	4.0 A 6.0 A (for 200 ms) from +55 °C (2 %/K)
Efficiency at rated values, approx.	80%	87%	88%	90%	89%
Signaling contact "DC o. k."	No	No	No	No	No
Parallel switching	Yes	Yes	Yes	Yes	Yes
No-load loss	< 0.3 W				< 0,3 W
Electronic short-circuit protection	Yes, constant current				Yes, constant current
EMF suppression (EN 55022)	Class B				Class B
Line harmonics limitation (EN 61000-3-2)	Not applicable				Yes
Degree of protection (EN 60529)	IP20				IP20
Ambient temperature	–25... +70 °C				–25... +70 °C
Dimensions (W x H x D) in mm	54 x 90 x 53				72 x 90 x 53
Weight approx.	0.2 kg				0.29 kg
Certification	CE, CB Scheme, cULus, cURus, SEMI F47, DNV, ABS, EAC	CE, CB Scheme, cULus, cURus, NEC Class 2, SEMI F47, DNV, ABS, EAC	CE, CB Scheme, cULus, cURus, NEC Class 2, SEMI F47, DNV, ABS, EAC	CE, CB Scheme, cULus, cURus, NEC Class 2, SEMI F47, DNV, ABS, SEMI 47, BV, LRS, EAC	CE, CB Scheme, cULus, cURus, SEMI F47, DNV, ABS, SEMI F47, BV, LRS, EAC, Ex-Variante: ATEX, IECEx, UKEx, Class I Div 2, CCC

SITOP in SIMATIC design



Technical data	SIMATIC S7-1200 design	SIMATIC S7-1500 design		SIMATIC ET 200SP design		SIMATIC ET 200pro design
Output voltage/current, type	24 V/2.5 A, PM1207	24 V/3 A, PM1507	24 V/8 A, PM1507	24 V/5 A, PS	24 V/10 A, PS	24 V/8 A, ET 200pro PS
Article No.	6EP1332-15H71	6EP1332-4BA00	6EP1333-4BA00	6EP7133-6AB00-0BN0	6EP7133-6AE00-0BN0	6ES7148-4PC00-0HA0
Rated input voltage	120/230 V AC, automatic range selection					
– Range	85...132/176...264 V AC	85...132/176...264 V AC		85...132/170...264 V AC		380–480 V 3 AC
Mains buffering	20 ms (at 93/187 V)					
Rated line frequency	50/60 Hz					
Rated input current	1.2/0.67 A	1.4/0.8 A	3.7/1.7 A	2.3/1.4 A	4.5/1.9 A	1 A
– Inrush current ¹⁾	< 13 A	< 23 A	< 67 A	< 40 A	< 60 A	< 40 A
– Recommended miniature circuit breaker. See also FAQ	16 A charact. B, 10 A charact. C	from 6 A charact. C, from 10 A charact. B	from 10 A charact. C, from 16 A charact. B	6 A charact. C		10 A charact. C
Rated output voltage	24 V DC	24 V DC	24 V DC	24 V DC	24 V DC	24 V DC
– Tolerance	± 3%	± 3%	± 3%	± 3%	± 3%	– 5%/+3%
– Setting range	–	–	–	22.8...28 V DC	22.8...28 V DC	–
– On/off switch	No	Yes	Yes	Yes	Yes	No
Rated output current	2.5 A	3 A	8 A	5 A	10 A	8 A
– Overload behavior (Extra Power für 5 s/min)	–	4.5 A	12 A	7,5 A	15 A	–
Efficiency at rated values, approx.	83%	87%	90%	88%	90%	88%
Signaling contact "DC o. k."	No	No	No	Yes	Yes	Yes, and for overtemperature
Parallel switching	Yes	Yes	Yes	Yes	Yes	No
Electronic short-circuit protection	Yes, constant current characteristic	Yes, restart	Yes, restart	Yes, constant current characteristic		Yes, restart
EMF suppression (EN 55022)	Class B	Class B	Class B	Class B	Class B	EN 61000-6-4 (Class A)
Line harmonics limitation (EN 61000-3-2)	Not applicable	Not applicable	Yes	Yes	Yes	No
Degree of protection (EN 60529)	IP20	IP20	IP20	IP20	IP20	IP67, UL: encl. type 5 indoor
Ambient temperature	0...+60 °C	0...+60 °C	0...+60 °C	–30...+70 °C	–30...+70 °C	–25...+55 °C
Installation	DIN rail or wall mounting	on S7-1500 system carrier	on S7-1500 system carrier	DIN rail		Screw mounting, e.g., on ET 200pro system rail
Dimensions (W x H x D) in mm	70 x 100 x 75	50 x 147 x 135	75 x 147 x 135	160 x 117 x 75		310x135.5 (w/o plug-in connection) x90
Weight approx.	0.3 kg	0.45 kg	0.74 kg	0.5 kg	0.8 kg	2.8 kg
Certification	CE, cULus, CB, FM, ATEX, IECEx, UKEx, CCC, cCSAus Class I Div 2, DNV, ABS	CE, cULus, CB, ATEX, IECEx, UKEx, CCC, cULus Class I Div 2, FM, DNV, ABS, BV		CE, cULus, CSA/UL, ATEX, IECEx, UKEx, CCC, ABS, DNV, FM		CE, cULus508

¹⁾ Inrush current can be limited using a SITOP inrush current limiter: [6EP4683-6LB00-0AY0](#) (max. 5 A, 100-240 V AC) or [6EP1967-2AA00](#) (max. 10 A, 100-480 V AC, 1 unit per phase required). Specifications at rated input voltage and ambient temperature +25 °C (unless otherwise specified).

DC/DC converter



Technical data	DC/DC converter									
Output voltage/current, type	24 V/2.5 A PSU3400 uni	24 V/4 A, PSU3400	12 V/8 A, PSU3400	24 V/5 A, PSU3400	12 V/15 A, PSU3400	24 V/10 A, PSU3400	24 V/3.5 A NEC Class 2, PSU3400	24 V/5 A, PSU3400	24 V/10 A, PSU3400	24 V/20 A, PSU400M
Article No.	6EP3332-0TA00-0AY0	6EP3133-0TA10-0AY0	6EP3123-0TA00-0AY0	6EP3133-0TA00-0AY0	6EP3124-0TA00-0AY0	6EP3134-0TA00-0AY0	6EP3233-0TA10-0AY0	6EP3233-0TA00-0AY0	6EP3234-0TA00-0AY0	6EP1536-3AA00
Rated input voltage	24 V DC, 230 V AC	12 V DC	24 V DC	24 V DC	24 V DC	24 V DC	48 V DC	48 V DC	48 V DC	600 V DC ¹⁾
– Range	18...264 V DC, 88...264 V AC	9...18 V DC	18...32 V DC, 14...18 V DC, short-term with derating possible	14...32 V DC, derating for 14...18 V DC	28...60 V DC, startup from 36 V, derating for 28–36 V	300...900 V DC, startup from approx. 340 V				
Mains buffering	> 5 ms	> 2 ms	> 5 ms	> 5 ms	> 5 ms	> 5 ms	> 5 ms	> 5 ms	> 5 ms	–
Rated input current	1.9 A (at 24 V DC)	9.0 A	4.5 A	5.5 A	8.4 A	10.8 A	1.9 A	2.7 A	5.4 A	0.85 A
– Inrush current	<15 A	<15 A	<15 A	<15 A	<15 A	<15 A	<15 A	<15 A	<15 A	<8 A
– Recommended miniature circuit breaker (not necessary in case of feed-in by SITOP) See also FAQ	16 A charact. B or C	16 A characteristic B or C	10 A characteristic B or C	16 A characteristic B or C	10 A characteristic B or C	16 A	10 A	16 A	10 A	–
Rated output voltage	24 V DC	24 V DC	12 V DC	24 V DC	12 V DC	24 V DC	24 V DC	24 V DC	24 V DC	24 V DC
– Tolerance	± 1%	± 2%	± 4%	± 2%	± 4%	± 2%	± 1%	± 2%	± 2%	± 3%
– Setting range	24...28 V DC	24...28 V DC	12...15.5 V DC	24...28 V DC	12...15.5 V DC	24...28 V DC	24...28 V DC	24...28 V DC	24...28 V DC	24...28.8 V DC
Rated output current	2.5 A	4 A	8 A	5 A	15 A	10 A	3.5 A	5 A	10 A	20 A
– Overload behavior	3.5 A	–	–	6 A up to 40 °C	–	12 A up to 40 °C	–	6 A up to 40 °C	12 A up to 40 °C	30 A
– Derating	–	from +60 °C (2%/K)	from +60 °C (2%/K)	from +60 °C (2%/K)	from +60 °C (2%/K)	from +60 °C (2%/K)	–	from +60 °C (2%/K)	from +60 °C (2%/K)	from +60 °C (5.5 %/K), 300...400 V DC, 824...900 V DC
Efficiency at rated values, approx.	85 %	89%	89.4%	92.5%	91%	93%	90.4%	91.6%	93.5%	95 %
Signaling contact “DC o. k.”	No	No	No	No	Yes	Yes	No	No	Yes	Yes
Parallel switching	Yes, 2 units	Yes, 2 units	Yes, 2 units	Yes, 2 units	Yes, 2 units	Yes, 2 units	–	Yes, 2 units	Yes, 2 units	Yes, output line switchable
Electronic short-circuit protection	Yes, restart									Yes, constant current or latching shutdown selectable
EMF suppression (EN 55022)	Class B	Class B	Class B	Class B	Class B	Class B	Class B	Class B	Class B	Class A (emission)
Line harmonics limitation (EN 61000-3-2)	Not applicable	Not applicable	Not applicable	Not applicable	Not applicable	Not applicable	Not applicable	Not applicable	Not applicable	No
Degree of protection (EN 60529)	IP20	IP20	IP20	IP20	IP20	IP20	IP20	IP20	IP20	IP20
Ambient temperature	–25...+70 °C	–25...+70 °C	–25...+70 °C	–25...+70 °C	–25...+70 °C	–25...+70 °C	–25...+70 °C	–25...+70 °C	–25...+70 °C	–25...+70 °C
Installation	DIN rail									
Dimensions (W x H x D) in mm	32 x 100 x 100				42 x 125 x 120	42 x 125 x 120	32 x 100 x 100	32 x 100 x 100	42 x 125 x 120	90 x 125 x 125
Weight approx.	0.3 kg	0,4 kg	0.4 kg	0.4 kg	0.6 kg	0.6 kg	0.4 kg	0.4 kg	0.6 kg	1.2 kg
Certification	CE, cULus	CE, cULus, ABS, DNV, NEC Class 2 for 6EP3233-0TA10-0AY0 only								CE, cULus, CB, DNV

¹⁾The SITOP PSU400M power supply is designed for connection to a DC link power system, which means that the input voltage rises and falls successively while charging the DC link.

Hot plug-in and hot plug-out of the input voltage above 450 V is not allowed. The [6EP1566-3AA00](#) ballast device for limiting the voltage rise must be used for this purpose.





Specifications at rated input voltage and ambient temperature +25 °C (unless otherwise specified).

SITOP in special designs and applications



Technical data	Wall mounting				
Output voltage/current, type	12 V/3 A, PSU100D	24 V/2,2 A, PSU100D	12 V/8,5 A, PSU100D	24 V/6,25 A, PSU100D	24 V/14,6 A, PSU100D
Article No.	6EP1321-1LD01	6EP1331-1LD01	6EP1322-1LD01	6EP1333-1LD01	6EP1334-1LD01
Rated input voltage	100-240 V AC	100-240 V AC	100-240 V AC	100-120/200-240 V AC (Voltage range selector switch)	100-120/200-240 V AC (Voltage range selector switch)
– Range	90...264 V AC	90...264 V AC	90...264 V AC	90...132/180...264 V AC	90...132/180...264 V AC
Mains buffering	> 16 ms (at 115/230 V)	> 12 ms (at 115/230 V)	> 9 ms (at 115/230 V)	> 30 ms (at 115/230 V)	> 20 ms (at 115/230 V)
Rated line frequency	50/60 Hz	50/60 Hz	50/60 Hz	50/60 Hz	50/60 Hz
Rated input current	0.85-0.5 A	1.2-0.7 A	2.2-1.2 A	3.0-1.6 A	6.8-3.4 A
– Inrush current ¹⁾	< 45 A	< 45 A	< 55 A	< 60 A	< 60 A
– Recommended miniature circuit breaker See also FAQ	16 A characteristic B				
Rated output voltage	12 V DC	24 V DC	12 V DC	24 V DC	24 V DC
– Tolerance	+/- 1%	+/- 1%	+/- 1%	+/- 1%	+/- 1%
– Setting range	10.8... 13.2 V DC	21.6... 26.4 V DC	10.8... 13.2 V DC	21.6... 26.4 V DC	21.6... 26.4 V DC
Rated output current	3 A	2.2 A	8.5 A	6.25 A	14.6 A
– Derating	from +50°C (2%/ K)				
Efficiency at rated values, approx.	86 %	88 %	87,5 %	89 %	87 %
Signaling contact "DC o. k."	No	No	No	No	No
Remote On/Off	No	No	No	No	No
Parallel switching	No				
Electronic short-circuit protection	Yes, restart				
EMF suppression (EN 55022)	Class B				
Line harmonics limitation (EN 61000-3-2)	Yes	Yes	Yes	No	Yes
Degree of protection (EN 60529)	IP 00				
Ambient temperature	-25°C...+70°C				
Installation	Wall mounting, variable mounting position				
Dimensions (W x H x D) in mm	82 x 99 x 29	82 x 99 x 29	97 x 129 x 30	97 x 129 x 30	115 x 215 x 30
Weight approx.	0.17 kg	0.18 kg	0.29 kg	0.36 kg	0.84 kg
Certification	CE, UKAC, cULus, cURus, BIS				

¹⁾Inrush current can be limited using a SITOP inrush current limiter: [6EP4683-6LB00-0AY0](#) (max. 5 A, 100-240 V AC). Specifications at rated input voltage and ambient temperature +25 °C (unless otherwise specified).

										
Two outputs		Flexible output 0–52 V		High degree of protection		Slim design		Flat design Slim design Power supplies for charging batteries		
2 x 15 V/3.5 A, SITOP PSU3600		3...52 V/10A, SITOP PSU3600		24 V/5 A, PSU100P	24 V/8 A, PSU100P ¹⁾	24 V/5 A, PSU300E	48 V/5 A, PSU100E	12 V/20 A, PSU3800	24 V/17 A, PSU3800	24 V/30 A, 40 A, PSU3800
6EP3323-0SA00-0BY0		6EP3343-0SA00-0AY0		6EP1333-7CA10	6EP1334-7CA10	6EP1433-0AA00	6EP3344-0SB00-0AY0	6EP3424-8UB00-0AY0	6EP3436-8UB00-0AY0	6EP3437-8UB00-0AY0 ¹⁾
120–230 V AC, 110–220 V DC 85...264 V AC, DC 88...250 V		120–230 V AC, 110–220 V DC 85...264 V AC, DC 88...250 V		120/230 V AC, automatic range switching 85... 132/170... 264 V AC		400 V 3 AC 320...480 V 3 AC	120/230 V AC 85... 132/170...264 V AC	400–500 V 3 AC 320...575 V 3 AC	400–500 V 3 AC 320...575 V 3 AC	400–500 V 3 AC 320...575 V 3 AC
> 80 ms (at 230 V AC)		> 80 ms (at 230 V AC)		> 40 ms (at I _{Out rated})	> 40 ms (at I _{Out rated})	> 50 ms (at 400 V)	> 20 ms (at 93/187 V)	> 15 ms (at 400 V)	> 15 ms (at 400 V)	> 10 ms (at 400 V)
50/60 Hz		50/60 Hz		50/60 Hz	50/60 Hz	50/60 Hz	50/60 Hz	50/60 Hz	50/60 Hz	50/60 Hz
2.2–1.3 A		2.6–1.3 A		2.25/1.24 A	3.5/1.52 A	0.36 A	4.4–2 A	0.7–0.6 A	1.2–1.0 A	2.1–1.7 A
< 35 A		< 35 A		< 15 A	< 15 A	< 15 A	< 58 A	< 18 A	< 18 A	< 13 A
6–10 A characteristic C		6–10 A characteristic C		ab 6 A charact. C/B	ab 6 A charact. C/B	6–10 A charact. C	10 A charact. C	6–16 A charact. C 3-ph. coupled or 3RV2011-1DA10 or 3RV2711-1DD10		10–16 A charact. C 3-ph. coupled or 3RV2011-1DA10 or 3RV2711-1DD10
2 x 15 V DC		24 V DC		24 V DC	24 V DC	24 V DC	48 V DC	12 V DC	24 V DC	24 V DC
± 1%		± 1%		± 3%	± 3%	± 3%	± 3%	± 3%	± 3%	± 3%
12...28 V DC		0...52 V DC ²⁾		–	–	24...29 V DC	48...54 V DC	12...14 V DC	24...28.8 V DC	24...28.8 V DC
2 x 3.5 A (max. 60 W per output)		2–10 A (max. 120 W)		5 A	8 A	5 A	5 A from +60 °C	20 A	17 A from +60 °C (1.7%/K)	30 A/40 A switchable from +60 °C (5%/K)
–		–		–	–	–	–	–	–	–
88%		88%		90%	93%	90%	92%	94%	94%	94%
No		Yes, and current monitor		Yes	Yes	Yes	Yes	Yes	Yes	Yes
No		No		No	No	No	No	Yes	Yes	Yes
Yes		Yes		Yes, 2 units	Yes, 2 units	No	Yes, 2 units	Yes	Yes	Yes
Yes, restart		Yes, constant current		Yes, restart	Yes, restart	Yes, restart	Yes, restart	Yes, constant current or latching shutdown selectable		
Class B		Class B		Class B	Class B	Class A	Class A	Class B	Class B	Class B
Yes		Yes		Yes	Yes	Yes	Yes	Yes	Yes	Yes
IP20		IP20		IP67, UL: enclosure type 5 indoor		IP20	IP20	IP20	IP20	IP20
–25...+70 °C		–25...+70 °C		–25...+60 °C	–25...+60 °C	0...+60 °C	–25...+70 °C	–25...+70 °C	–25...+70 °C	–25...+70 °C
DIN rail		DIN rail		Screw mounting	Screw mounting	DIN rail	DIN rail	DIN rail	DIN rail	DIN rail
42 x 125 x 125		42 x 125 x 135		120 x 181 x 60,5		42 x 125 x 125	42 x 125 x 125	70 x 125 x 125	70 x 125 x 125	135 x 145 x 150
0.55 kg		0.55 kg		1.1 kg	1.3 kg	0.6 kg	0.5 kg	1.2 kg	1.2 kg	3.3 kg
CE, cULus, NEC Class 2		CE, cULus		CE, cULus	CE, cULus	CE, cULus	CE, cULus	CE, cULus, DNV, ABS		CE; cULus, CB, SEMI F47, DNV, ABS

¹⁾ Inrush current can be limited using a SITOP inrush current limiter: [6EP4683-6LB00-0AY0](#) (max. 5 A, 100–240 V AC) or [6EP1967-2AA00](#) (max. 10 A, 100–480 V AC, 1 unit per phase required).

²⁾ Via analog control voltage signal 0...2.5 V

Specifications at rated input voltage and ambient temperature +25 °C (unless otherwise specified).

SITOP expansion modules

to increase system availability



Technical data	Redundancy					
SITOP	SITOP RED1200 redundancy module			SITOP PSE202U redundancy module		
Article No.	6EP4346-7RB00-0AX0	6EP4347-7RB00-0AX0	6EP4348-7RB00-0AX0	6EP1964-2BA00	6EP1962-2BA00	6EP1961-3BA21
Article No. Ex version		6EP4347-7RC00-0AX0				
Rated input voltage – Range	12 V, 24 V, 48 V DC 10...58 V DC	12 V, 24 V, 48 V DC 10...58 V DC	12 V, 24 V, 48 V DC 10...58 V DC	24 V DC 19...29 V DC	24 V DC 19...29 V DC	24 V DC 24...28.8 V DC
Brief description of product/function	Module for redundancy mode and for decoupling power supplies with output voltages from 12 to 48 V, e.g. for series connection to increase voltage to up to 96 V or parallel connection of more than 2 power supplies to enhance performance.			Module for redundancy mode; floating relay contact and green LED for signaling "Infeed 1 and 2 o.k.", switching threshold adjustable between 20 and 25 V DC		
Possible combinations	Decoupling of two 12 V to 48 V power supplies with output currents up to 10 A or one 20-A power supply per redundancy module	Decoupling of two 12 V to 48 V power supplies with output currents up to 20 A or one 40-A power supply per redundancy module	Decoupling of two 12 V to 48 V power supplies with output currents up to 40 A	Decoupling of two 24-V power supplies up to 5 A or one 10-A power supply per redundancy module	Decoupling and limitation of the output to Class-2 limit (100 VA) of two 24-V power supplies 5 to 40 A	Decoupling of two 24-V power supplies 5 A to 20 A or one 40-A power supply per redundancy module
Rated output current	20 A (total output current)	40 A (total output current)	80 A (total output current)	10 A (total output current)	3.5 A ¹⁾	40 A (total output current)
Reverse voltage protection	170 V DC	170 V DC	170 V DC	52 V DC	52 V DC	52 V DC
Efficiency at rated values, approx.	97.5 %	97.5 %	97.5 %	97 %	95 %	97 %
EMF suppression (EN 55022)	Class B	Class B	Class B	Class B	Class B	Class B
Degree of protection (EN 60529)	IP20	IP20	IP20	IP20	IP20	IP20
Terminals	Push-in	Push-in	Screw terminals	Screw terminals	Screw terminals	Screw terminals
Ambient temperature	-25...+70 °C	-25...+70 °C	-25...+70 °C	-20...+70 °C	-20...+70 °C	-25...+60 °C
Dimensions (W x H x D) in mm	35 x 135 x 125	45 x 135 x 125	45 x 135 x 155	30 x 80 x 100	30 x 80 x 100	70 x 125 x 125
Weight approx.	0.35 kg	0.35 kg	0.99 kg	0.125 kg	0.125 kg	0.5 kg
Certification	CE, cULus, CB, pending: DNV, ABS. Ex version: ATEX, IECEx, UKEx, Class I Div 2, CCC			CE, cULus	CE, cULus, NEC Class 2	CE, cULus, DNV, ABS

¹⁾ Max. 8 A net current in event of fault in accordance with NEC Class 2 Specifications at rated input voltage and ambient temperature +25 °C (unless otherwise specified).

NEW



Technical data				Monitoring								
SITOP	SITOP SEL1200 selectivity module with switching characteristic				SITOP SEL1400 selectivity module with current limiting characteristic			SITOP PSE200U selectivity module with current limiting characteristic and common signaling contact		SITOP PSE200U selectivity module with current limiting characteristic and single-channel signaling		
Article No.	6EP4437-7FB00-3CX0	6EP4437-7FB00-3DX0	6EP4438-7FB00-3DX0	6EP4448-7FB00-3CX0	6EP4437-7EB00-3CX0	6EP4437-7EB00-3DX0	6EP4438-7EB00-3DX0	6EP1961-2BA11	6EP1961-2BA21	6EP1961-2BA31	6EP1961-2BA41	
Article No. with NEC Class 2								6EP1961-2BA51		6EP1961-2BA61		
Article No. Ex version			6EP4438-7FC00-3DX0				6EP4438-7EC00-3DX0					
Rated input voltage/range	24 V DC/20..4...30 V DC			48 V DC/40...56 V DC	24 V DC/20,4...30 V DC			24 V DC/22...30 V DC		24 V DC/22...30 V DC		
Brief product description	Module for distributing the DC-supply over up to four or eight load circuits and their monitoring for overload; selective shutdown of faulty load circuits, rated current individually adjustable; universal use for all power supplies											
Switch-off characteristic	Switching – for standard protection. Release time depending on overcurrent				Current limiting – for increased safeguarding requirements; current limitation to 150 % (110 % for NEC Class 2 variants) of the set threshold value, then shutdown. Voltage dip below 20 V not possible, therefore also suitable for loads that do not meet the PLC standard							
Status indication per output	3-color LED: green – connected, yellow – manually disconnected, red – disconnected due to overcurrent											
Signal outputs	Diagnostics interface for common signaling or single-channel diagnostics. Analysis of single-channel diagnostics via SIMATIC S7 function block: current, set current threshold value, status (on/off), reason for disconnection (if applicable)							Common signaling contact. Voltage measuring points for current value per output (1 V ± 1 A)		Single-channel signaling for channel-specific analysis via SIMATIC S7-function block. Voltage measuring points for current value per output (1 V ± 1 A)		
Reset, outputs switched on/off	Remote reset with 24-V signal. Reset and each output switched on/off via push button											
Individual load circuits switched on sequentially	Load-optimized (previous output less than set rated value) + 25 ms, + 200 ms, or + 500 ms							0 ms (simultaneously), 25 ms, 100 ms or load-optimized (previous output less than set rated value)				
Rated output current	4 x 10 A	8 x 5 A	8 x 10 A	4 x 10 A	4 x 10 A	8 x 5 A	8 x 10 A	4 x 3 A	4 x 10 A	4 x 3 A	4 x 10 A	
– Setting range	2...10 A	1...5 A	2...10 A	1...10 A	2...10 A	1...5 A	2...10 A	0.5...3 A	3...10 A	0.5...3 A	3...10 A	
Efficiency at rated values, approx.	typ. 98%	typ. 98%	typ. 98%	typ. 99%	typ. 98%	typ. 99%	typ. 98%	97%	99%	97%	99%	
Parallel switching of 2 outputs	Yes (max. 15 A)	Yes (max. 7,5 A)	Yes (max. 15 A)	Yes (max. 15 A)	Yes (max. 15 A)	Yes (max. 7,5 A)	Yes (max. 15 A)	No	No	No	No	
Electronic short-circuit protection	Yes	Yes	Yes	Yes	Yes	Yes	Yes	Yes	Yes	Yes	Yes	
Radio interference suppression (EN 55022)	Class B	Class B	Class B	Class B	Class B	Class B	Class B	Class B	Class B	Class B	Class B	
Degree of protection (EN 60529)	IP20	IP20	IP20	IP20	IP20	IP20	IP20	IP20	IP20	IP20	IP20	
Terminals	Push-in	Push-in	Push-in	Push-in	Push-in	Push-in	Push-in	Screw terminals	Screw terminals	Screw terminals	Screw terminals	
Ambient temperature	-25...+70 °C	-25...+70 °C	-25...+70 °C	-25...+70 °C	-25...+70 °C	-25...+70 °C	-25...+70 °C	-25...+60 °C	-25...+60 °C	-25...+60 °C	-25...+60 °C	
Dimensions (W x H x D) in mm	45 x 135 x 125	45 x 135 x 125	45 x 135 x 125	45 x 135 x 125	45 x 135 x 125	45 x 135 x 125	45 x 135 x 125	72 x 80 x 72	72 x 80 x 72	72 x 80 x 72	72 x 80 x 72	
Weight approx.	0.3 kg	0.3 kg	0.3 kg	0.3 kg	0.3 kg	0.4 kg	0.5 kg	0.2 kg	0.2 kg	0.2 kg	0.2 kg	
Certification	CE, UR, cULus, CB, CSA, pending: DNV and ABS. Ex version: ATEX, IECEx, UKEx, CCC, Class I Div 2							CE, UR, cULus, CB, DNV, ABS. NEC Class 2 for 6EP1961-2BA51/6EP1961-2BA61 only				

Specifications at rated input voltage and ambient temperature at +25 °C (unless otherwise specified)

SITOP expansion modules to increase system availability

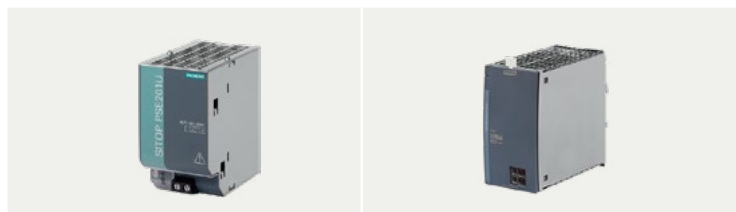

Technical data	Mains buffering up to the seconds range	
SITOP	Buffer module ¹⁾ SITOP PSE201U	Buffer module SITOP BUF1200
Buffer time/Energy	200 ms/40 A	300 ms/40 A
Article No.	6EP1961-3BA01	6EP4231-7HB00-0AX0
Article No. Ex version		6EP4231-7HC00-0AX0
Input voltage	24 V DC/24...28.8 V DC	24 V DC/20...30 V DC
Rated input current	Module for buffering during short power failures; parallel connection at output of 24-V power supplies ¹⁾ . Buffering time 200 ms at 40 A up to 1.6 s at 5 A load current; multiplication possible through parallel connection; maximum buffering time 10 s	Module for buffering during short power failures; parallel connection at output of 24-V power supplies. Buffering time 300 ms at 40 A up to 2.4 s at 5 A load current; multiplication possible through parallel connection
Rated output voltage		
Rated output current		
Efficiency at rated values, approx.		
Overload and short-circuit protection		
Parallel switching	Yes	Yes
EMF suppression (EN 55022)	Class B	Class B
Degree of protection (EN 60529)	IP20	IP20
Ambient temperature	-25 ...+70 °C	-25 ...+70 °C
Dimensions (W x H x D) in mm	70 x 125 x 125	70 x 135 x 155
Weight approx.	1.2 kg	1.5 kg
Certification	CE, UL, CSA, DNV, ABS	CE, cULus, CB. Pending: DNV, ABS, Ex version: ATEX, IECEx, UKEx, Class I Div 2, CCC

Uninterruptible power supplies – **SITOP UPS500** maintenance-free DC UPS with capacitor technology

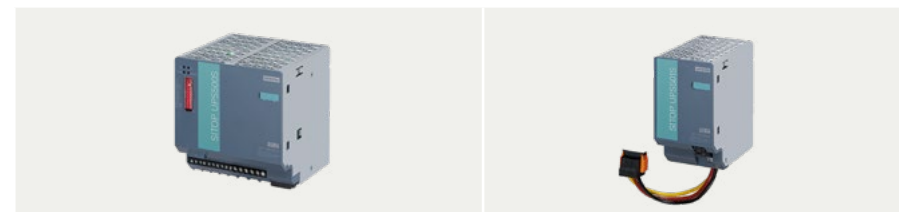

Mains buffering up to the minutes range		
UPS500S – basic unit 15 A		UPS501S – expansion module
2.5 kW	5 kW	5 kW
6EP1933-2EC41	6EP1933-2EC51	6EP1935-5PG01
	6EP1 933-2EC51-8AA0	6EP1935-5PG01-8AA0
24 V DC, 22...29 V, infeed from SITOP 24 V		Infeed from basic unit
15.2 A + approx. 2.3 A in charging mode		
In buffer and normal mode 24 V DC ± 3 %		Description: expansion module for extending the buffering time, up to three units can be switched in parallel with one UPS500S basic unit
15 A, charging current 1 A (factory setting) or 2 A selectable		
97.5 %		
Electronic, automatic restart		
No		Yes, up to three units
Class B	Class B	Class B
IP20	IP20	IP20
0...+60 °C	0...+60 °C	0...+60 °C
120 x 125 x 125	120 x 125 x 125	70 x 125 x 125
1.0 kg	1.0 kg	0.7 kg
CE, cULus, CB, DNV, ABS. Ex version: ATEX, IECEx, UKEx, Class I Div 2, CCC		

¹⁾ Parallel switching at output of SITOP PSU8200, PSU6200, and SITOP smart 24 V power supplies (except [6EP1 336-2BA10](#)) Specifications at rated input voltage and ambient temperature +25 °C (unless otherwise specified).

Buffering times and charging times **SITOP UPS500**



Configurations SITOP UPS500S/501S

Basic unit	2.5 kW	5 kW	2.5 kW	5 kW	2.5 kW	5 kW	2.5 kW	5 kW
Expansion modules	–	–	1 x 5 kW	1 x 5 kW	2 x 5 kW	2 x 5 kW	3 x 5 kW	3 x 5 kW
Total energy	2.5 kW	5 kW	7.5 kW	10 kW	12.5 kW	15 kW	17.5 kW	20 kW

Buffering times

Load current

0.5 A	134 s	236 s	390 s	478 s	632 s	748 s	851 s	1007 s
0.8 A	90 s	167 s	266 s	346 s	440 s	527 s	580 s	706 s
1 A	75 s	138 s	219 s	296 s	365 s	414 s	490 s	572 s
2 A	38 s	76 s	122 s	156 s	203 s	230 s	265 s	306 s
3 A	26 s	52 s	82 s	106 s	136 s	159 s	186 s	213 s
4 A	19 s	39 s	61 s	81 s	101 s	120 s	139 s	160 s
5 A	15 s	31 s	49 s	65 s	81 s	95 s	111 s	130 s
6 A	12 s	26 s	40 s	55 s	67 s	80 s	94 s	106 s
7 A	10 s	21 s	34 s	47 s	58 s	69 s	81 s	82 s
8 A	8 s	18 s	29 s	40 s	50 s	59 s	69 s	79 s
10 A	6 s	15 s	23 s	32 s	39 s	47 s	54 s	62 s
12 A	4 s	12 s	19 s	26 s	32 s	38 s	44 s	52 s
15 A	3 s	9 s	14 s	20 s	25 s	30 s	35 s	40 s

Charging times

Charging current

2 A	54 s	120 s	158 s	223 s	263 s	318 s	355 s	417 s
1 A	110 s	205 s	311 s	425 s	503 s	625 s	695 s	816 s

Specifications at rated input voltage and ambient temperature at +25 °C (unless otherwise specified)

Uninterruptible power supplies

SITOP DC UPS with battery modules for bridging longer power failures



Technical data	Mains buffering up to the hours range				
SITOP	UPS1600	UPS1600	UPS1600	Battery module BAT1600	Battery module BAT1600
Energy storage				LiFePO4 batteries	Lead batteries
Output voltage/current or charge	24 V/10 A	24 V/20 A	24 V/40 A	24 V/2.5 Ah Li	24 V/3.2 Ah
				for UPS1600 10 A	for UPS1600 10 A und 20 A
Article No.	6EP4134-3AB00-0AY0	6EP4136-3AB00-0AY0	6EP4137-3AB00-0AY0	6EP4132-OJA00-0AY0	6EP4133-OGA00-0AY0
– with USB interface	6EP4134-3AB00-1AY0	6EP4136-3AB00-1AY0	6EP4137-3AB00-1AY0		
– with Ethernet/PROFINET interface	6EP4134-3AB00-2AY0	6EP4136-3AB00-2AY0	6EP4137-3AB00-2AY0		
– Version suitable for air freight with 30% charge				6EP4132-OJA00-0AY0-Z A03	
– Ex version		6EP4136-3AC00-0AY0			6EP4133-OGD00-0AY0
– Ex version with Ethernet/PROFINET interface		6EP4136-3AC00-2AY0			
Input voltage	24 V DC, 22...29 V, infeed from 24-V SITOP power supply			Recommended end-of-charge voltage (set automatically by SITOP UPS1600)	
Rated input current	approx. 14 A at max. charging current (3 A)	approx. 25 A at max. charging (4 A)	approx. 46 A at max. charging (5 A)	Charging current max. 3 A	Charging current max. 0.8 A
Rated output voltage	24 V DC (upstream SITOP device or battery), charging voltage: 27.0 V			24 V DC	24 V DC
Rated output current	10 A, charging current max. 3 A	20 A, charging current max. 4 A	40 A, charging current max. 5 A	10 A	20 A
– Overload behavior (power boost for 30 ms)	30 A	60 A	120 A		
– Overload behavior (extra power for 5 s/min)	15 A	30 A	60 A		
Relative temporary capacity loss at 20°C per month, typical				2.5 Ah Li: 1 %	3.2 Ah Pb: 3 %
Efficiency at rated values, approx.	> 97.7 %	> 98.2 %	> 98.8 %	Not applicable	Not applicable
Efficiency at rated values, approx.	Yes, restart in normal mode			Installed battery fuse: 15 A/32 V	Installed battery fuse: 25 A/32 V
Parallel switching	No	No	No	Yes, up to 6 units	Yes, up to 6 units
EMF suppression (EN 55022)	Class B	Class B	Class B	–	–
Degree of protection (EN 60529)	IP20	IP20	IP20	IP20	IP20
Ambient temperature (derating from +60 °C)	–25...+70 °C	–25...+70 °C	–25...+70 °C	–10...+50 °C	–15...+50 °C
Installation	DIN rail	DIN rail	DIN rail	DIN rail or wall mounting ¹⁾	
Dimensions (W x H x D) in mm	50 x 125 x 125	50 x 125 x 125	70 x 125 x 150	89 x 156 x 129	89 x 156 x 169
Weight approx.	0.38 kg/0.4 kg/0.44 kg	0.39 kg/0.41 kg/0.45 kg	0.65 kg/0.65 kg/0.7 kg	2.0 kg	3.8 kg
Certification	CE, cULus, CB, DNV, ABS. Ex version: ATEX, IECEx, UKEx, Class I Div 2, CCC			CE, UL-listed (UL 621010, CSA C22.2 No. 107.1) DNV, ABS. Ex version: ATEX, IECEx, UKEx, Class I Div 2, CCC	

¹⁾ With [6EP4990-0MK00-0XU0](#) wall-mounting kit (2 pcs)
Specifications at rated input voltage and ambient temperature +25 °C (unless otherwise specified).

SITOP BAT1600 – Service life



Mains buffering up to the hours range		
Battery module BAT1600	Battery module BAT1600	Battery module BAT1600
LiFePO4 batteries	Lead batteries	Lead batteries
24 V/7.5 Ah Li	24 V/12 Ah Pb	24 V/38 Ah Pb
for UPS1600 10 A, 20 A, and 40 A <u>6EP4134-0JA00-0AY0</u>	for UPS1600 10 A, 20 A, and 40 A <u>6EP4135-0GE00-0AY0</u>	for UPS1600 10 A, 20 A, and 40 A <u>6EP4137-0GE00-0AY0</u>
<u>6EP4134-0JA00-0AY0-Z A03</u>		
	<u>6EP4135-0GL00-0AY0</u>	
Recommended end-of-charge voltage (set automatically by SITOP UPS1600)		
Charging current max. 3 A	Charging current max. 3 A	Charging current max. 3 A
24 V DC	24 V DC	24 V DC
40 A	40 A	40 A
1 %	3 %	3 %
Not applicable	Not applicable	Not applicable
Installed battery fuse: 50 A/32 V	Installed battery fuse: 50 A/32 V	Installed battery fuse: 50 A/32 V
Yes, up to 6 units	Yes, up to 6 units	Yes, up to 6 units
–	–	–
IP20	IP20	IP20
–10...+50 °C	–10...+50 °C	–15...+50 °C
DIN rail or wall mounting ¹⁾	Wall mounting	Floor mounting
238 x 156 x 129	238 x 156 x 125	394 x 212 x 165
4.0 kg	9.8 kg	28.4 kg
CE, UL-listed (UL 621010, CSA C22.2 No. 107.1) DNV, ABS. Ex version: ATEX, IECEx, UKEx, Class I Div 2, CCC		

¹⁾ With 6EP4990-0MK00-0XU0 wall-mounting kit (2 pcs)



SITOP BAT1600	2.5 Ah Li	3.2 Ah Pb	7.5 Ah Li	12 Ah Pb	38 Ah Pb
Service life of energy storage device					
– typical	Capacity falls to 80% of original capacity (according to EUROBAT)				
Comment					
– at 20°C typical	11 years	4 years	11 years	4 years	10 years
– at 30°C typical	11 years	2 years	11 years	2 years	5 years
– at 40°C typical	8 years	1 year	8 years	1 year	2.5 years
– at 50°C typical	6 years	0.5 years	6 years	0.5 years	1.25 years
– at 60°C typical	2 years	0 years	2 years	0 years	0 years

Buffer times

The correct DC-UPS configuration that takes into account the buffer time, load current, ambient temperature, and minimum buffer voltage can be selected in the TIA Selection Tool (also see p. 14): [siemens.com/tst-powersupply](https://www.siemens.com/tst-powersupply)

Find out more:

[siemens.com/sitop](https://www.siemens.com/sitop)

Additional information on SITOP:

- › TIA Selection Tool:
[siemens.com/tst-powersupply](https://www.siemens.com/tst-powersupply)
- › Operating instructions as download:
www.siemens.com/sitop-manuals
- › Request CAx data via the CAx download manager:
[siemens.com/cax](https://www.siemens.com/cax)

More
about
SITOP on
YouTube

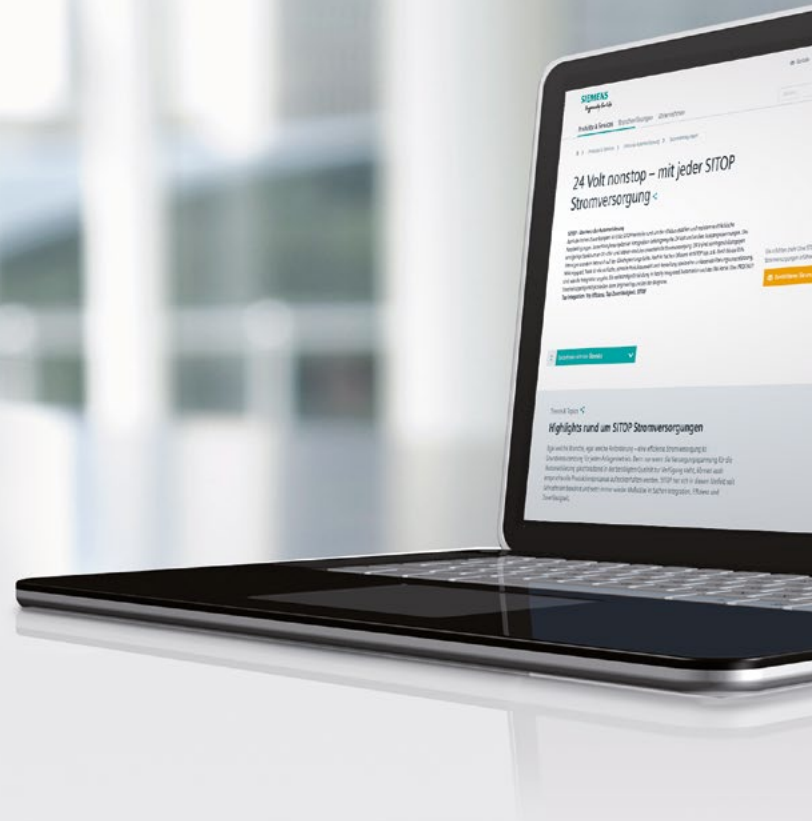

Subject to changes and errors. The information provided in this brochure contains descriptions or performance characteristics which, in case of actual use, do not always apply as described or which may change as a result of further development of the products. The desired performance characteristics are only binding if expressly agreed in the contract. Availability and technical specifications are subject to change without notice.

All product designations may be trademarks or product names of Siemens AG or supplier companies, the use of which by third parties for their own purposes may violate the rights of the owners.

Industrial Security

Siemens provides automation and drive products with industrial-security functions that support the secure operation of plants or machines. They are an important component in a holistic industrial-security concept. With this in mind, our products undergo continuous development. We therefore recommend that you keep yourself informed with respect to our product updates and that you use only the latest versions. Please find further information on this subject at [automation.siemens.com/support](https://www.automation.siemens.com/support).

You may also register for a product-specific newsletter at this address.

To ensure the secure operation of a plant or machine it is also necessary to take suitable preventive action (e.g., cell protection concept) and to integrate the automation and drive components into a state-of-the-art holistic industrial-security concept for the entire plant or machine. Any third-party products that may be in use must also be taken into account. Please find further information at [siemens.com/industrialsecurity](https://www.siemens.com/industrialsecurity).

Published by
Siemens AG

Digital Industries
Process Automation
Östliche Rheinbrückenstr. 50
76187 Karlsruhe, Germany

For the U.S. published by
Siemens Industry Inc

100 Technology Drive
Alpharetta, GA 30005
United States

Follow us on:

twitter.com/siemensindustry

youtube.com/siemens

Article No.: DIPA-B10072-05-7600 ipdf
Dispo 26000
WS 1023
© Siemens 2023