

## Switching devices – Contactors and contactor assemblies – for switching motors



	<b>Price groups</b> PG 41B, 41E, 41H, 42F
3/2	<b>Introduction</b>
	<b>Power contactors for switching motors</b>
3/8	General data
3/18	SIRIUS 3RT contactors, 3-pole up to 250 kW Accessories for SIRIUS 3RT contactors and SIRIUS 3RH2 contactor relays
3/69	- General data
3/81	- Auxiliary switches, instantaneous <b>NEW</b>
3/95	- Auxiliary switches, delayed
3/97	- Surge suppressors
3/99	- Modules for contactor control
3/104	- Link modules
3/109	- Connection modules/adapters
3/112	- Covers
3/113	- Miscellaneous accessories Spare parts for SIRIUS 3RT contactors and SIRIUS 3RH2 contactor relays
3/116	- Solenoid coils
3/119	- Contacts and arc chutes
3/120	SIRIUS 3RT12 and 3TF6 vacuum contactors
3/133	Accessories and spare parts for SIRIUS 3RT12 and 3TF6 vacuum contactors
3/138	3TG10 power relays/miniature contactors
	<b>Reversing contactor assemblies</b>
3/142	SIRIUS 3RA23 reversing contactor assemblies, up to 55 kW
3/153	Reversing contactor assemblies consisting of SIRIUS 3RT1 and 3TF6 contactors, up to 335 kW
	<b>Contactor assemblies for star-delta (weye-delta) starting</b>
3/158	SIRIUS 3RA24 contactor assemblies for star-delta (weye-delta) starting, up to 90 kW
3/171	Contactor assemblies for star-delta (weye-delta) starting consisting of SIRIUS 3RT and 3TF6 contactors, up to 710 kW

# Switching devices – Contactors and contactor assemblies – for switching motors

## Introduction

## Overview

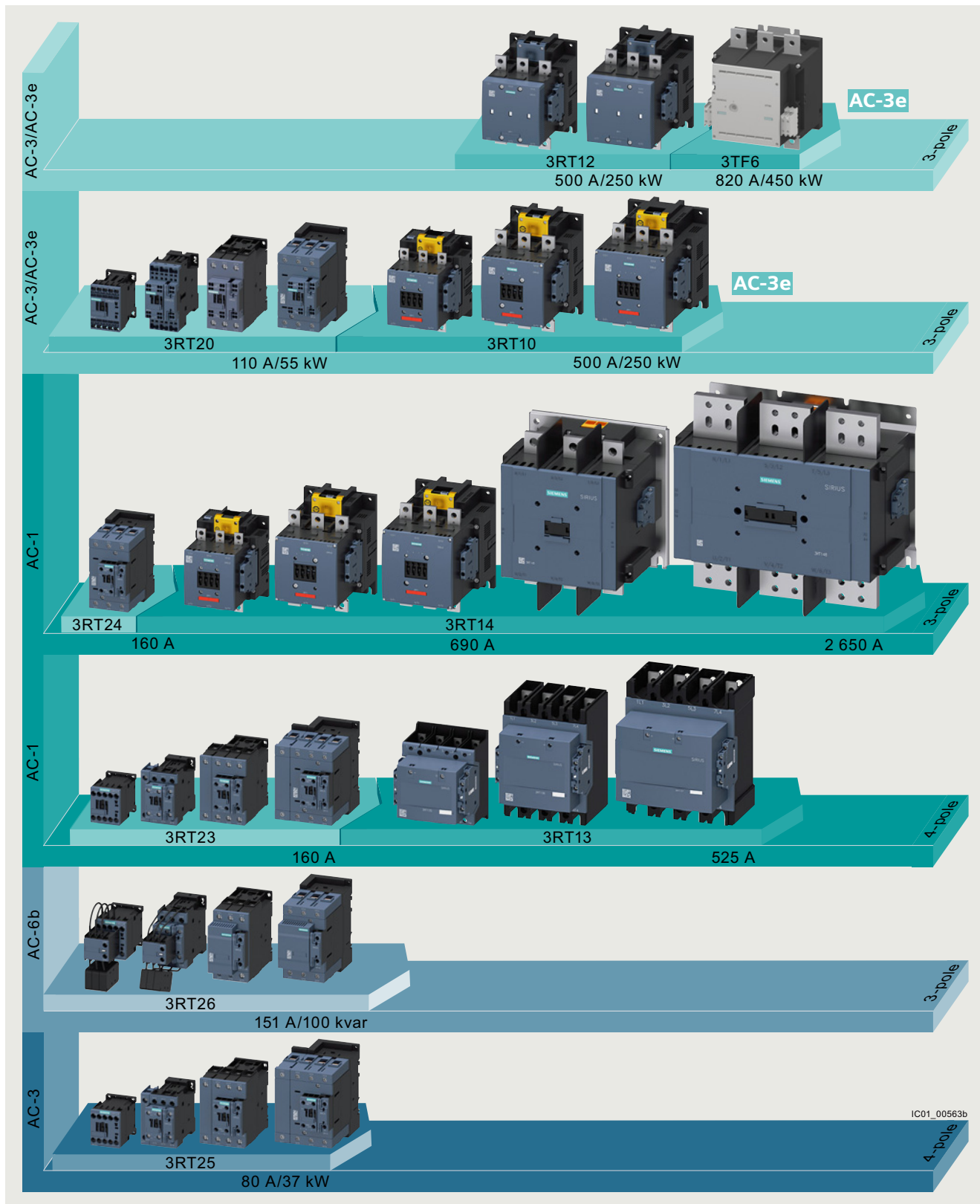

Overview of the 3RT and 3TF contactors



## More information

Homepage, see [www.siemens.com/sirius](http://www.siemens.com/sirius)Industry Mall, see [www.siemens.com/product?3RT\\_3TK\\_3TC](http://www.siemens.com/product?3RT_3TK_3TC)Conversion tool, see [www.siemens.com/conversion-tool](http://www.siemens.com/conversion-tool)TIA Selection Tool Cloud (TST Cloud), see [www.siemens.com/tstcloud/?node=Contactor](http://www.siemens.com/tstcloud/?node=Contactor)Size  
Type**S00**  
3RT201**S0**  
3RT202**3RT20 contactors**

Type		<b>3RT2015</b>	<b>3RT2016</b>	<b>3RT2017</b>	<b>3RT2018</b>	<b>3RT2023</b>	<b>3RT2024</b>	<b>3RT2025</b>	<b>3RT2026</b>	<b>3RT2027</b>	<b>3RT2028</b>
AC, DC operation		(p. 3/47, 3/52 ... 3/55)				(p. 3/48, 3/49, 3/56 ... 3/58, 3/60)					
<b>AC-3 and AC-3e</b>											
$I_e$ /AC-3/AC-3e/400 V	A	7	9	12	16	9	12	17	25	32	38
<b>400 V</b>	<b>kW</b>	<b>3</b>	<b>4</b>	<b>5.5</b>	<b>7.5</b>	<b>4</b>	<b>5.5</b>	<b>7.5</b>	<b>11</b>	<b>15</b>	<b>18.5</b>
230 V	kW	1.5	2.2	3	4	2.2	3	4	5.5	7.5	11
500 V	kW	6	7.7	9.2	12.4	9	12	17	18	32	32
690 V	kW	4	5.5	5.5	7.5	7.5	7.5	11	11	18.5	18.5
1 000 V	kW	--	--	--	--	--	--	--	--	--	--
<b>AC-4 (at <math>I_a = 6 \times I_e</math>)</b>											
<b>400 V</b>	<b>kW</b>	<b>3</b>	<b>4</b>	<b>4</b>	<b>5.5</b>	<b>4</b>	<b>5.5</b>	<b>7.5</b>	<b>7.5</b>	<b>11</b>	<b>11</b>
400 V (200 000 operating cycles)	kW	1.15	2	2	2.5	2	2.6	3.5	4.4	6	6
<b>AC-1 (40 °C, ≤ 690 V)</b>											
$I_e$	<b>A</b>	<b>18</b>	<b>22</b>	<b>22</b>	<b>22</b>	<b>40</b>	<b>40</b>	<b>40</b>	<b>40</b>	<b>50</b>	<b>50</b>

**Accessories for contactors**

<b>Auxiliary switches</b>	<ul style="list-style-type: none"> <li>On the front</li> <li>Lateral</li> </ul>	<b>3RH29, 3RA28</b>		(p. 3/87 ... 3/95)	<b>3RH29, 3RA28</b>		(p. 3/87 ... 3/95)
		<b>3RH29</b>		(p. 3/91 ... 3/94)	<b>3RH29</b>		(p. 3/91 ... 3/94)
<b>Function modules</b>	<ul style="list-style-type: none"> <li>Direct-on-line starting, star-delta (wye-delta) starting</li> <li>IO-Link, AS-Interface</li> </ul>	<b>3RA281.</b>		(p. 3/100)	<b>3RA281.</b>		(p. 3/100)
		<b>3RA271.-.AA00</b>		(p. 3/101, 3/102)	<b>3RA271.-.AA00</b>		(p. 3/101, 3/102)
<b>Surge suppressors</b>		<b>3RT2916</b>		(p. 3/97, 3/98)	<b>3RT2926</b>		(p. 3/97, 3/98)

**3RU2 and 3RB3 overload relays**

<b>3RU thermal overload relays</b>		<b>3RU2116</b>	0.11 ... 16 A	(p. 7/89)	<b>3RU2126</b>	1.8 ... 40 A	(p. 7/89)
<b>3RB electronic overload relays</b>		<b>3RB3016, 3RB3113</b>	0.1 ... 16 A	(p. 7/102 ... 7/104)	<b>3RB3026, 3RB3123</b>	0.1 ... 40 A	(p. 7/102 ... 7/104)
<ul style="list-style-type: none"> <li>For standard applications</li> <li>For High-Feature applications</li> </ul>		<b>3RB22, 3RB23 and 3RB24 with current measuring module 3RB2906-2.G1</b>	0.3 ... 25 A	(p. 7/125, 7/133)	<b>3RB22, 3RB23 and 3RB24 with current measuring module 3RB2906-2.G1</b>	0.3 ... 25 A	(p. 7/125, 7/133)

**3RV20 motor starter protectors**

<b>Motor starter protectors</b>		<b>3RV2011</b>	0.11 ... 16 A	(p. 7/27)	<b>3RV2021</b>	0.45 ... 40 A	(p. 7/28)
<b>Link modules</b>		<b>3RA1921, 3RA2911</b>		(p. 7/61)	<b>3RA2921</b>		(p. 7/61)

**3RA23 reversing contactor assemblies**

<b>Complete units</b>	Type	<b>3RA2315</b>	<b>3RA2316</b>	<b>3RA2317</b>	<b>3RA2318</b>	--	<b>3RA2324</b>	<b>3RA2325</b>	<b>3RA2326</b>	<b>3RA2327</b>	<b>3RA2328</b>	
		(p. 3/149)					(p. 3/150)					
<b>400 V</b>	<b>kW</b>	<b>3</b>	<b>4</b>	<b>5.5</b>	<b>7.5</b>		<b>5.5</b>	<b>7.5</b>	<b>11</b>	<b>15</b>	<b>18.5</b>	
<b>Assembly kits/wiring modules</b>		<b>3RA2913-2AA.</b>				(p. 3/104)	<b>3RA2923-2AA.</b>					(p. 3/104)
<b>Function modules</b>		<b>3RA271.-.BA00</b>				(p. 3/101)	<b>3RA271.-.BA00</b>					(p. 3/101)

**3RA24 contactor assemblies for star-delta (wye-delta) starting**

<b>Complete units</b>	Type	<b>3RA2415</b>	<b>3RA2416</b>	<b>3RA2417</b>		<b>3RA2423</b>	<b>3RA2425</b>	<b>3RA2426</b>		
		(p. 3/167)				(p. 3/168)				
<b>400 V</b>	<b>kW</b>	<b>5.5</b>	<b>7.5</b>	<b>11</b>		<b>11</b>	<b>15/18.5</b>	<b>22</b>		
<b>Assembly kits/wiring modules</b>		<b>3RA2913-2BB.</b>				(p. 3/105)	<b>3RA2923-2BB.</b>			(p. 3/105)
<b>Function modules</b>		<b>3RA271.-.CA00</b>				(p. 3/101)	<b>3RA271.-.CA00</b>			(p. 3/101)

Note:

Safety characteristics for contactors, see "Standards and approvals", page 16/9.

## Switching devices – Contactors and contactor assemblies – for switching motors

## Introduction

Size  
Type**S2**  
3RT203**S3**  
3RT204**3RT20 contactors**

Type	3RT2035	3RT2036	3RT2037	3RT2038	3RT2045	3RT2046	3RT2047
AC, DC operation	(p. 3/50, 3/59, 3/61)				(p. 3/51, 3/59, 3/63)		

**AC-3 and AC-3e**

$I_e$ /AC-3/AC-3e/400 V	A	41	50	65	80	80	95	110
<b>400 V</b>	<b>kW</b>	<b>18.5</b>	<b>22</b>	<b>30</b>	<b>37</b>	<b>37</b>	<b>45</b>	<b>55</b>
230 V	kW	11	15	18.5	22	22	22	30
500 V	kW	41	51	65	80	80	95	110
690 V	kW	22	22	37	45	55	75	90
1 000 V	kW	--	--	--	--	37	37	37

**AC-4 (at  $I_a = 6 \times I_e$ )**

<b>400 V</b>	<b>kW</b>	<b>18.5</b>	<b>22</b>	<b>30</b>	<b>37</b>	<b>37</b>	<b>45</b>	<b>55</b>
400 V (200 000 operating cycles)	kW	11.6	12.6	14.7	15.8	17.9	22	24.3

**AC-1 (40 °C, ≤ 690 V)**

$I_e$	A	60	70	80	90	125	130	130
-------	---	----	----	----	----	-----	-----	-----

**Accessories for contactors**

<b>Auxiliary switches</b>	<ul style="list-style-type: none"> <li>On the front</li> <li>Lateral</li> </ul>	3RH29, 3RA28 3RH29	(p. 3/87 ... 3/95) (p. 3/91 ... 3/94)	3RH29, 3RA28 3RH29	(p. 3/87 ... 3/95) (p. 3/91 ... 3/94)
<b>Function modules</b>	<ul style="list-style-type: none"> <li>Direct-on-line starting</li> <li>IO-Link, AS-Interface</li> </ul>	3RA283. 3RA271.-.AA00	(p. 3/100) (p. 3/101, 3/102)	3RA283. 3RA271.-.AA00	(p. 3/100) (p. 3/101, 3/102)
<b>Surge suppressors</b>		3RT2936	(p. 3/97, 3/98)	3RT2936, 3RT2946	(p. 3/97, 3/98)
<b>Terminal covers</b>		3RT2936-4EA2	(p. 3/112)	3RT2946-4EA2	(p. 3/112)

**3RU2 and 3RB overload relays**

<b>3RU thermal overload relays</b>	3RU2136	11 ... 80 A	(p. 7/90)	3RU2146	28 ... 100 A	(p. 7/90)
<b>3RB electronic overload relays</b>						
<ul style="list-style-type: none"> <li>For standard applications</li> </ul>	3RB3036, 3RB3133	12.5 ... 80 A	(p. 7/102 ... 7/104)	3RB3046, 3RB3143	12.5 ... 115 A	(p. 7/102 ... 7/104)
<ul style="list-style-type: none"> <li>For High-Feature applications</li> </ul>	3RB22, 3RB23 and 3RB24 with current measuring module 3RB2906-2JG1	10 ... 100 A	(p. 7/125, 7/133) (p. 7/137)	3RB22, 3RB23 and 3RB24 with current measuring module 3RB2906-2JG1	10 ... 100 A	(p. 7/125, 7/133) (p. 7/137)

**3RV20 motor starter protectors**

<b>Motor starter protectors</b>	3RV2031, 3RV2032	9.5 ... 80 A	(p. 7/30)	3RV2041, 3RV2042	28 ... 100 A	(p. 7/30)
<b>Link modules</b>	3RA2931		(p. 7/61)	3RA1941		(p. 7/61)

**3RA23 reversing contactor assemblies**

Complete units	Type	3RA2335	3RA2336	3RA2337	3RA2338	3RA2345	3RA2346	3RA2347
		(p. 3/151)			(p. 3/152)			
<b>400 V</b>	<b>kW</b>	<b>18.5</b>	<b>22</b>	<b>30</b>	<b>37</b>	<b>37</b>	<b>45</b>	<b>55</b>
<b>Assembly kits/wiring modules</b>		3RA2933-2AA.			3RA2943-2AA.			
		(p. 3/104)			(p. 3/104)			
<b>Function modules</b>		3RA271.-.BA00			3RA271.-.BA00			
		(p. 3/101)			(p. 3/101)			
<b>Mechanical interlocks</b>		3RA2934-2B			3RA2934-2B			
		(p. 3/108)			(p. 3/108)			

**3RA24 contactor assemblies for star-delta (wye-delta) starting**

Complete units	Type	3RA2434	3RA2435	3RA2436	3RA2437	3RA2444	3RA2445	3RA2446
		(p. 3/169)			(p. 3/170)			
<b>400 V</b>	<b>kW</b>	<b>22/30</b>	<b>37</b>	<b>45</b>	<b>55</b>	<b>55</b>	<b>75</b>	<b>90</b>
<b>Assembly kits/wiring modules</b>		3RA2933-2BBJ-2C			3RA2943-2BBJ-2C			
		(p. 3/105)			(p. 3/105)			
<b>Function modules</b>		3RA271.-.CA00			3RA271.-.CA00			
		(p. 3/101)			(p. 3/101)			

Note:

Safety characteristics for contactors, see "Standards and approvals", page 16/9.



Size	S6			S10			S12		
Type	3RT105			3RT1.6			3RT1.7		
<b>3RT10 contactors · 3RT12 vacuum contactors</b>									
Type	<b>3RT1054</b>	<b>3RT1055</b>	<b>3RT1056</b>	<b>3RT1064</b>	<b>3RT1065</b>	<b>3RT1066</b>	<b>3RT1075</b>	<b>3RT1076</b>	
AC, DC operation	(p. 3/64 ... 3/66)			(p. 3/64 ... 3/66)			(p. 3/64 ... 3/66)		
Type	--	--	--	<b>3RT1264</b>	<b>3RT1265</b>	<b>3RT1266</b>	<b>3RT1275</b>	<b>3RT1276</b>	
				(p. 3/130)			(p. 3/130)		
<b>AC-3 and AC-3e</b>									
$I_e$ /AC-3/AC-3e/400 V	A	115	150	185	225	265	300	400 500	
<b>400 V</b>	<b>kW</b>	<b>55</b>	<b>75</b>	<b>90</b>	<b>110</b>	<b>132</b>	<b>160</b>	<b>200 250</b>	
230 V	kW	37	45	55	55	75	90	132 160	
500 V	kW	75	90	132	160	160	200	250 315 (355) <sup>1)</sup>	
690 V	kW	110	132	160	On request	On request	On request	400 400 (500) <sup>1)</sup>	
1 000 V	kW	75	90	90	90 (315) <sup>1)</sup>	132 (355) <sup>1)</sup>	132 (400) <sup>1)</sup>	250 (560) <sup>1)</sup> 250 (710) <sup>1)</sup>	
<b>AC-4 (at <math>I_a = 6 \times I_e</math>)</b>									
<b>400 V</b>	<b>kW</b>	<b>55</b>	<b>75</b>	<b>90</b>	<b>110</b>	<b>132</b>	<b>160</b>	<b>200 250</b>	
400 V (200 000 operating cycles)	kW	29	38	45	54 (78) <sup>1)</sup>	66 (93) <sup>1)</sup>	71 (112) <sup>1)</sup>	84 (140) <sup>1)</sup> 98 (161) <sup>1)</sup>	
<b>AC-1 (40 °C, ≤ 690 V)</b>									
$I_e$	A	<b>160</b>	<b>185</b>	<b>215</b>	<b>275 (330)<sup>1)</sup></b>	<b>330</b>	<b>330</b>	<b>430 (610)<sup>1)</sup> 610</b>	
<b>3RT14 AC-1 contactors</b>									
Type	<b>3RT1456</b>		(p. 4/17, 4/18)	<b>3RT1466</b>	<b>3RT1467</b>	(p. 4/17, 4/18)	<b>3RT1476</b>		
$I_e$ /AC-1/40 °C/≤ 690 V	A	<b>275</b>		<b>400</b>	<b>500</b>		<b>690</b>		
<b>Accessories for contactors</b>									
<b>Auxiliary switches</b>	• On the front • Lateral	<b>3RH19, 3RT1926</b> <b>3RH19</b>			(p. 3/90, 3/96) (p. 3/92 ... 3/94)				
<b>Surge suppressors</b>		<b>3RT1956-1C</b> (RC element)			(p. 3/98)				
<b>Terminal covers</b>		<b>3RT1956-4EA.</b>			(p. 3/112)				
<b>Box terminal blocks</b>		<b>3RT1955-4G, 3RT1956-4G</b>			(p. 3/110)				
<b>3RB2 overload relays</b>									
<b>3RB electronic overload relays</b>		<b>3RB2056</b> 50 ... 200 A (p. 7/114, 7/115) <b>3RB2153</b> 50 ... 200 A (p. 7/116)			<b>3RB2066</b> 55 ... 250 A or 160 ... 630 A <b>3RB2163</b> 55 ... 250 A or 160 ... 630 A				
• For standard applications									
• For High-Feature applications		<b>3RB22, 3RB23 and 3RB24 with current measuring module 3RB2956-2TH2</b> 20 ... 200 A (p. 7/125, 7/133) (p. 7/137)			<b>3RB22, 3RB23 and 3RB24 with current measuring module 3RB2966-2WH2</b> 63 ... 630 A (p. 7/125, 7/133) (p. 7/137)				
<b>3VA2 molded case motor starter protectors</b>									
<b>Molded case motor starter protectors</b>									(See Catalog LV 10)
• for 3RT10 • for 3RT12		<b>3VA21</b> <b>3VA21</b>	<b>3VA22</b> <b>3VA22</b>	<b>3VA22</b> <b>3VA22</b>	<b>3VA23</b> <b>3VA23</b>	<b>3VA23</b> <b>3VA23</b>	<b>3VA24</b> <b>3VA24</b>	<b>3VA24</b> <b>3VA25</b> <b>3VA25</b>	
<b>Reversing contactor assemblies<sup>2)</sup></b>									
<b>Complete units</b>	Type	--							
<b>400 V</b>	<b>kW</b>	<b>55</b>	<b>75</b>	<b>90</b>	<b>110</b>	<b>132</b>	<b>160</b>	<b>200 250</b>	
<b>Assembly kits/wiring modules</b>		<b>3RA1953-2A</b>			<b>3RA1963-2A</b>			<b>3RA1973-2A</b>	
		(p. 3/104)			(p. 3/104)			(p. 3/104)	
<b>Mechanical interlocks</b>		<b>3RA1954-2A</b>							
		(p. 3/108)							
<b>Contactor assemblies for star-delta (wye-delta) starting<sup>2)</sup></b>									
<b>Complete units</b>	Type	--							
<b>400 V</b>	<b>kW</b>	--							
<b>Assembly kits/wiring modules</b>		<b>3RA1953-2B</b>			<b>3RA1963-2B</b>			<b>3RA1973-2B</b>	
		(p. 3/106)			(p. 3/106)			(p. 3/106)	

1) Value applies for 3RT12 contactors.

2) Contactor assemblies for customer assembly:  
- Reversing contactor assemblies, see pages 3/154 to 3/156,  
- Contactor assemblies for star-delta (wye-delta) starting, see pages 3/172 to 3/177.**Note:**

Safety characteristics for contactors, see "Standards and approvals", page 16/9.

## Switching devices – Contactors and contactor assemblies – for switching motors

## Introduction



Size **14**  
Type **3TF68**

Size **14**  
Type **3TF69**

**3TF68/3TF69 vacuum contactors**

Type	<b>3TF68</b> (p. 3/131, 3/132)	<b>3TF69</b> (p. 3/131, 3/132)
------	-----------------------------------	-----------------------------------

**AC-3 and AC-3e**

$I_e$ /AC-3/AC-3e/690 V	A	630	820 (630) <sup>1)</sup>
<b>400 V</b>	<b>kW</b>	<b>335</b>	<b>450 (335)<sup>1)</sup></b>
230 V	kW	200	260 (200) <sup>1)</sup>
690 V	kW	600	800 (600) <sup>1)</sup>
1 000 V	kW	600	800

**AC-4** (at  $I_a = 6 \times I_e$ )

<b>400 V</b>	<b>kW</b>	<b>355</b>	<b>400</b>
400 V (200 000 operating cycles)	kW	168	191

**AC-1** (40 °C, ≤ 690 V)

$I_e$	A	<b>700</b>	<b>910</b>
-------	---	------------	------------

**Accessories for contactors****Auxiliary switches**

• Lateral	<b>3TY7561</b>	(p. 3/133)
-----------	----------------	------------

<b>Surge suppressors</b>	<b>3TX7572</b>	(p. 3/134)
--------------------------	----------------	------------

<b>Terminal covers</b>	<b>3TX7686, 3TX7696</b>	(p. 3/134)
------------------------	-------------------------	------------

**3RB2 overload relays****3RB electronic overload relays**

• For standard applications	<b>3RB2066, 3RB2163</b>	55 ... 250 A or 160 ... 630 A	(p. 7/114, 7/115) (p. 7/116)	<b>3RB22, 3RB23 and 3RB24 with current measuring module 3RB2906-2.G1 with 3UF series transformer up to 820 A</b>	(p. 7/125, 7/133) (p. 7/137)
• For High-Feature applications	<b>3RB22, 3RB23 and 3RB24 with current measuring module 3RB2966-2WH2</b>	63 ... 630 A	(p. 7/137)		63 ... 820 A

**3VA2 molded case motor starter protectors**

<b>Molded case motor starter protectors</b>	<b>3VA25</b>	(See Catalog LV 10)
---	--------------	---------------------

**Reversing contactor assemblies<sup>2)</sup>**

<b>Complete units</b>	Type	--
<b>400 V</b>	<b>kW</b>	<b>335</b>
<b>Assembly kits/wiring modules</b>	<b>3TX7680-1A</b>	(p. 3/135)
<b>Mechanical interlocks</b>	<b>3TX7686-1A</b>	(p. 3/135)

**Contactor assemblies for star-delta (wye-delta) starting<sup>2)</sup>**

<b>Complete units</b>	Type	--
<b>400 V</b>	<b>kW</b>	<b>710</b>
<b>Assembly kits/wiring modules</b>	<b>3TX7680-1B</b>	(p. 3/135)

<sup>1)</sup> Value applies for utilization category AC-3e.

<sup>2)</sup> Contactor assemblies for customer assembly:  
- Reversing contactor assemblies, see page 3/157,  
- Contactor assemblies for star-delta (wye-delta) starting, see page 3/178.

Note:

Safety characteristics for contactors, see "Standards and approvals", page 16/9.



Type | 3TG10

### 3TG10 power relays/miniature contactors



Number of main contacts | 4  
AC, DC operation | (p. 3/138)

AC-1			
$I_e$ at 400 V	55 °C	A	20
$P$ at 400 V		kW	13
At 230 V		kW	7.5
AC-3			
$I_e$ up to 400 V		A	8.4
$P$ at 400 V		kW	4
AC-3e			
$I_e$ up to 400 V		A	6.4
$P$ at 400 V		kW	3

### Connection methods

The 3RT contactors are available with screw terminals (box terminals or flat connectors) or with spring-loaded terminals.

The 3TG10 power relays/miniature contactors are available with screw terminals or flat connectors.

-  Screw terminals
-  Spring-loaded terminals
-  Flat connectors

The terminals are indicated in the corresponding tables by the symbols shown on orange backgrounds.

### Voltage data

The data for 3-phase power systems according to IEC 60947-4-1 are valid for the following line system configurations:

Voltage data $U_e$	Line system configurations	
	Three-phase four-wire systems	Three-phase three-wire systems
230	--	230
400	230/400	400
440	260/440	440
500	--	500
690	400/690	690 (only from size S3)
1 000	--	1 000

-- Not specified

### Use of 3RT contactors, 3RT and 3TF vacuum contactors, reversing contactor assemblies, and contactor assemblies for star-delta (wye-delta) starting with IE3 and IE4 motors

#### Note:

For the use of 3RT contactors, 3RT and 3TF vacuum contactors, reversing contactor assemblies and contactor assemblies for star-delta (wye-delta) starting in conjunction with highly efficient IE3 and IE4 motors, please observe the information on dimensioning and configuring, see [Application Manual](#).

For more information, see page 1/8.

# Switching devices – Contactors and contactor assemblies – for switching motors

## Power contactors for switching motors

### General data

#### Overview

##### The SIRIUS family of controls

The SIRIUS modular system with its components for the switching, starting, protection and monitoring of motors and industrial systems stands for the fast, flexible and space-saving construction of control cabinets.

##### 3RT2.1 contactors · Size S00 with mountable accessories

The figure shows the version with screw terminals

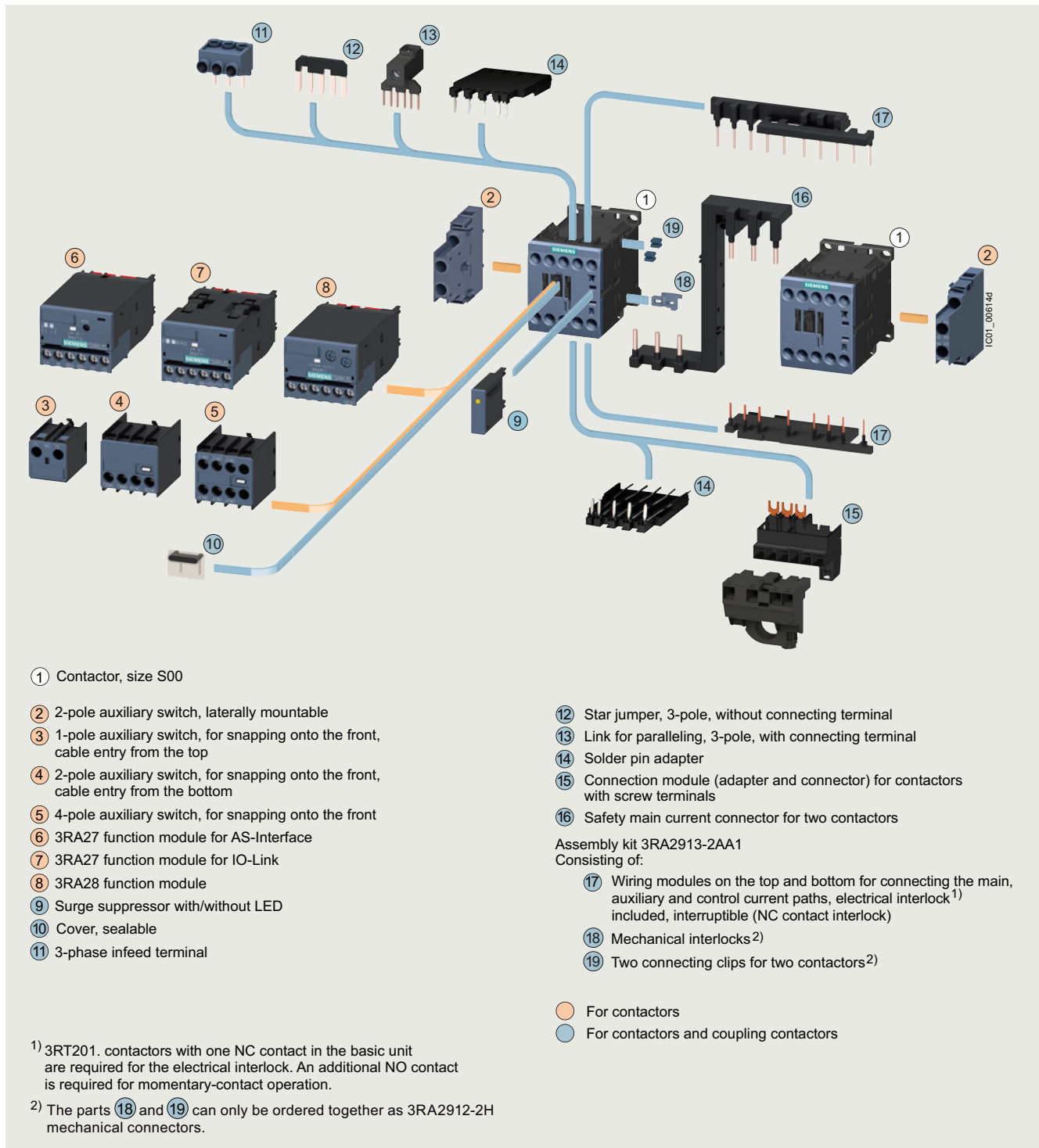

Accessories and spare parts, see pages 3/69 to 3/119.



# Switching devices – Contactors and contactor assemblies – for switching motors

## Power contactors for switching motors

General data

### 3RT2.2 contactors · Size S0 with mountable accessories

The figure shows the version with screw terminals

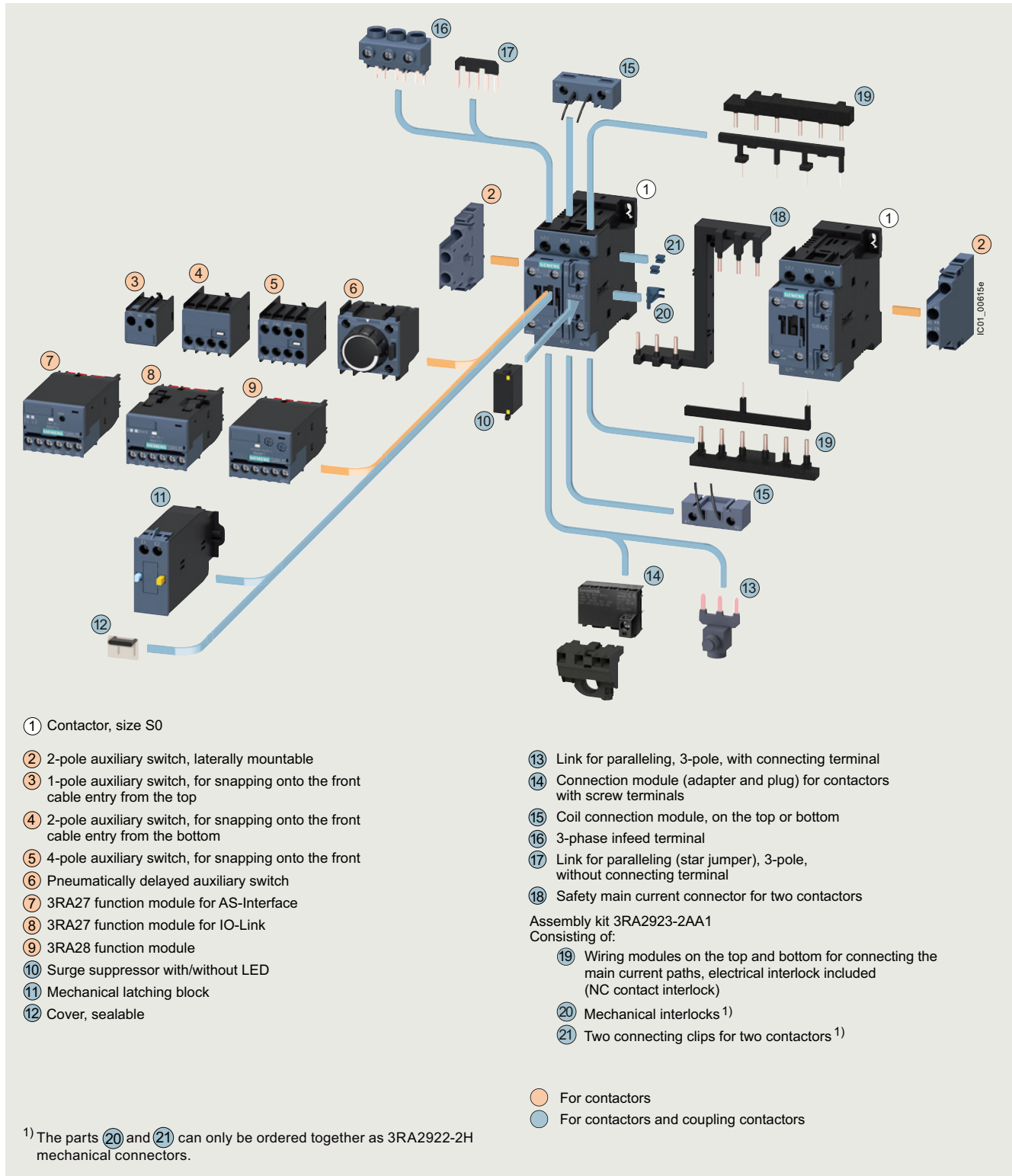

Accessories and spare parts, see pages 3/69 to 3/119.

# Switching devices – Contactors and contactor assemblies – for switching motors

## Power contactors for switching motors

### General data

#### 3RT2.3 contactors · Size S2 with mountable accessories

The figure shows the version with screw terminals

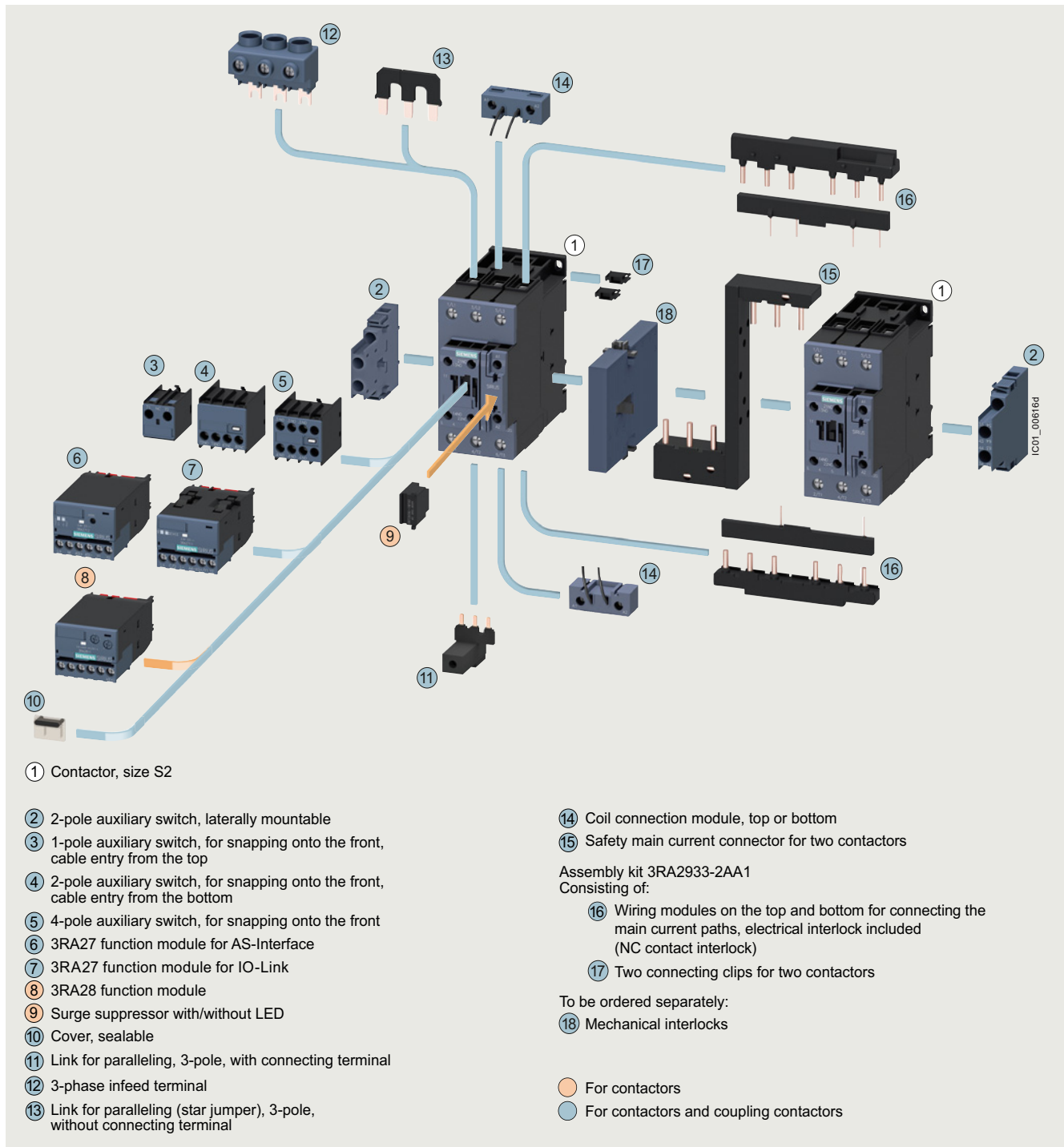

Accessories and spare parts, see pages 3/69 to 3/119.

## Switching devices – Contactors and contactor assemblies – for switching motors

### Power contactors for switching motors

General data

#### 3RT2.4 contactors · Size S3 with mountable accessories

The figure shows the version with screw terminals

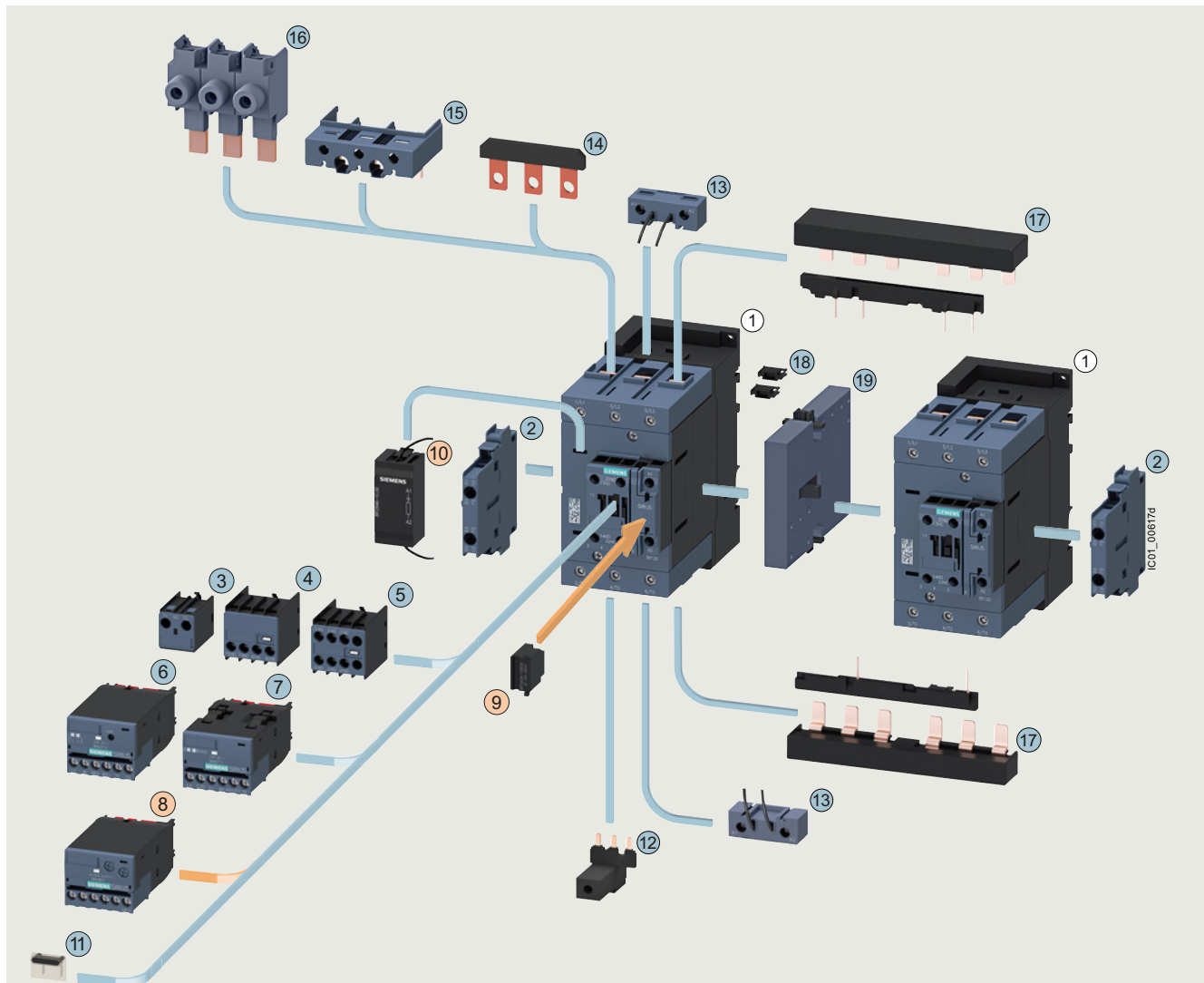

① Contactor, size S3

② 2-pole auxiliary switch, laterally mountable

③ 1-pole auxiliary switch, for snapping onto the front, cable entry from the top

④ 2-pole auxiliary switch, for snapping onto the front, cable entry from the bottom

⑤ 4-pole auxiliary switch, for snapping onto the front

⑥ 3RA27 function module for AS-Interface

⑦ 3RA27 function module for IO-Link

⑧ 3RA28 function module

⑨ Surge suppressor with/without LED (Varistor, diode assembly), can be plugged in on the front

⑩ Surge suppressor without LED (RC element), can be plugged in on the front in the recesses on the left next to the connection block

⑪ Cover, sealable

⑫ Links for paralleling, 3-pole, with connecting terminal

⑬ Coil connection module, top or bottom

⑭ Links for paralleling (star jumper), 3-pole, without connecting terminal

⑮ Auxiliary conductor terminal, 3-pole

⑯ Single-phase infeed terminals (3 units)

Assembly kit 3RA2943-2AA1

Consisting of:

⑰ Wiring modules on the top and bottom for connecting the main, auxiliary and control current paths, electrical interlock<sup>1)</sup> included, interruptible (NC contact interlock)

⑱ Two connectors for two contactors

To be ordered separately:

⑲ Mechanical interlock

<sup>1)</sup> 3RT201. contactors with one NC contact in the basic unit are required for the electrical interlock. An additional NO contact is required for momentary-contact operation.

○ For contactors

● For contactors and coupling contactors

Accessories and spare parts, see pages 3/69 to 3/119.

# Switching devices – Contactors and contactor assemblies – for switching motors

## Power contactors for switching motors

### General data

#### 3RT105 and 3RT145 contactors · Size S6 with mountable accessories

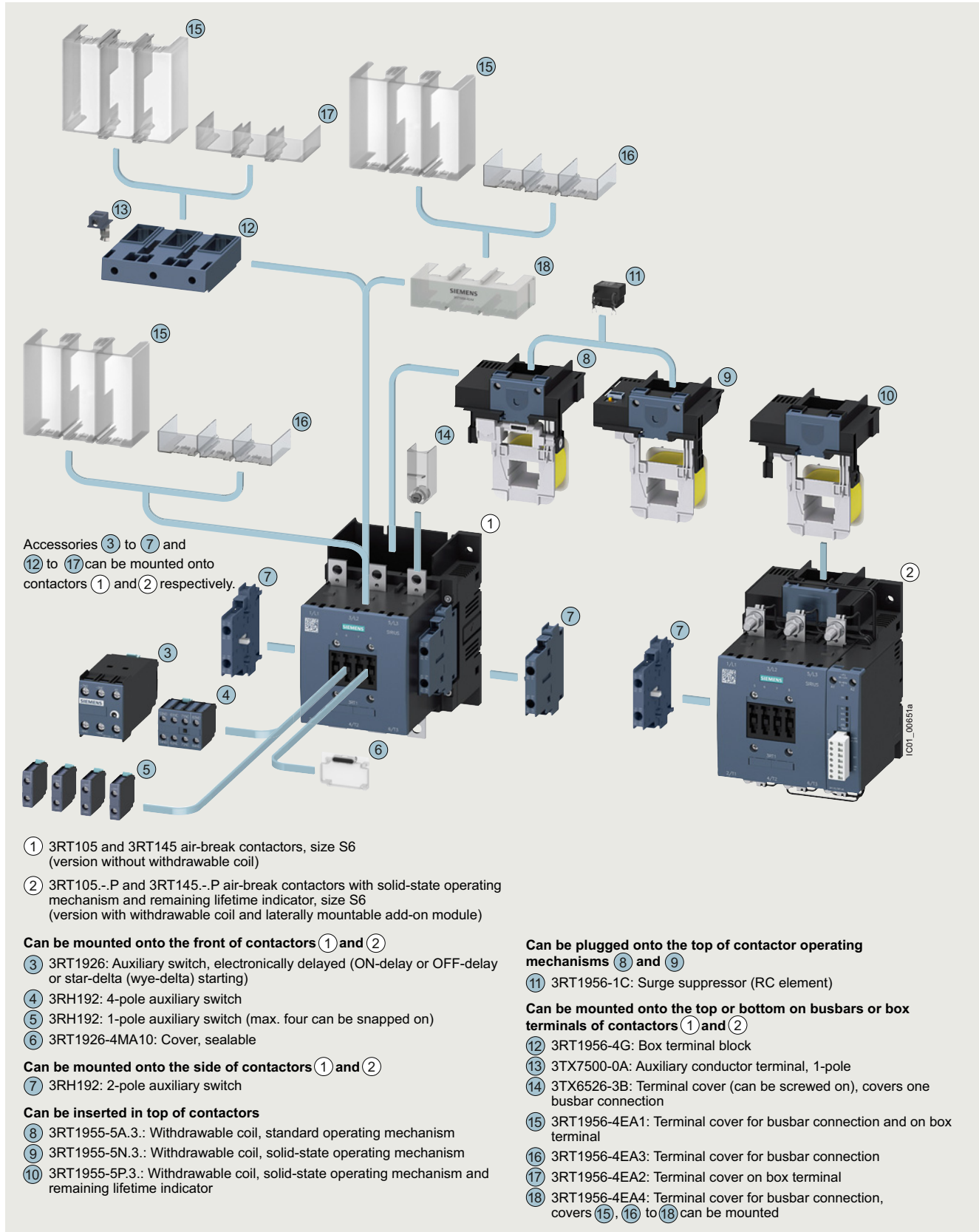

Accessories and spare parts, see pages 3/69 to 3/119.

# Switching devices – Contactors and contactor assemblies – for switching motors

## Power contactors for switching motors

General data

### 3RT106 and 3RT146 contactors · Size S10 with mountable accessories

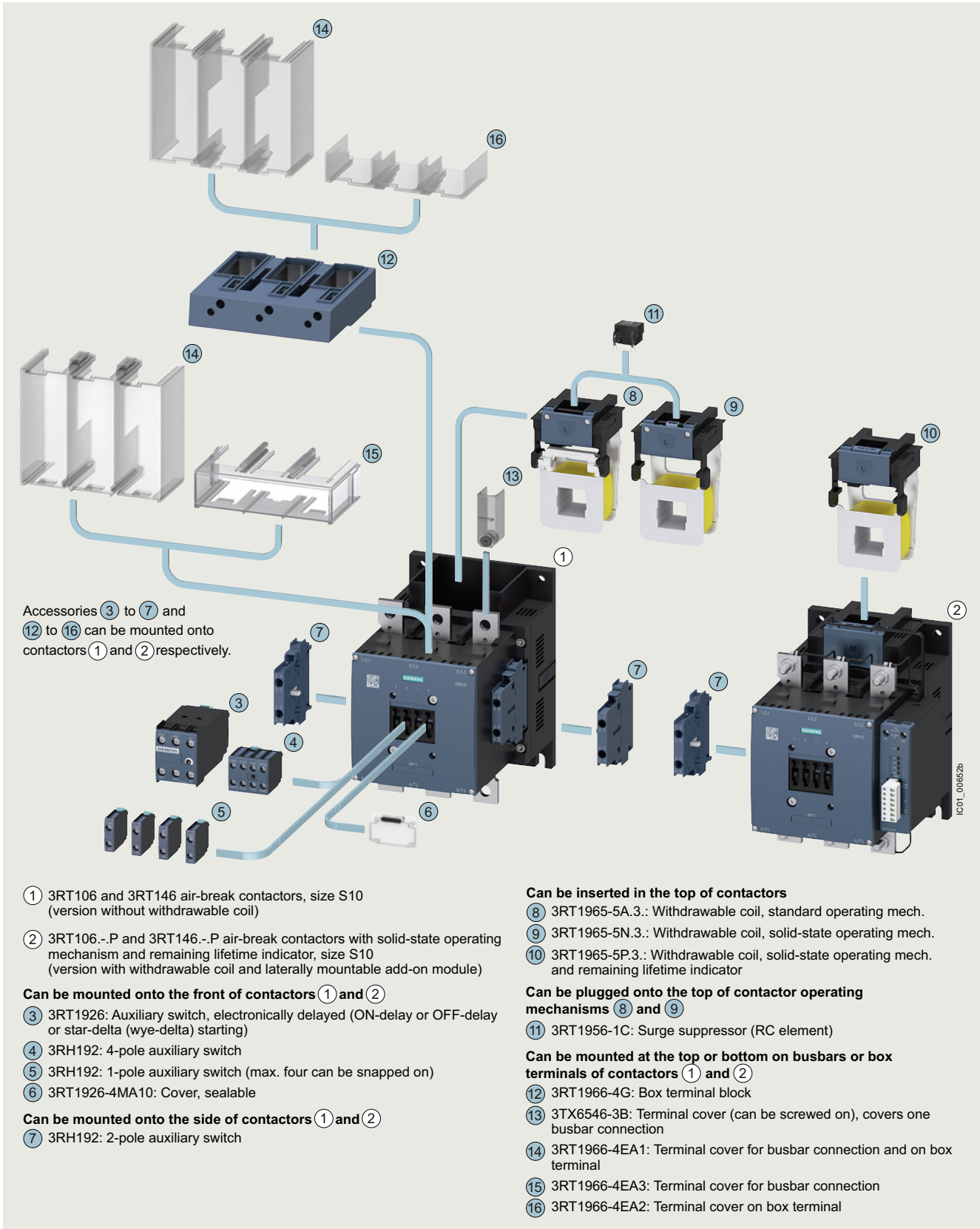

Accessories and spare parts, see pages 3/69 to 3/119.



## Switching devices – Contactors and contactor assemblies – for switching motors

### Power contactors for switching motors

#### General data

#### 3RT126 vacuum contactors · Size S10 with mountable accessories

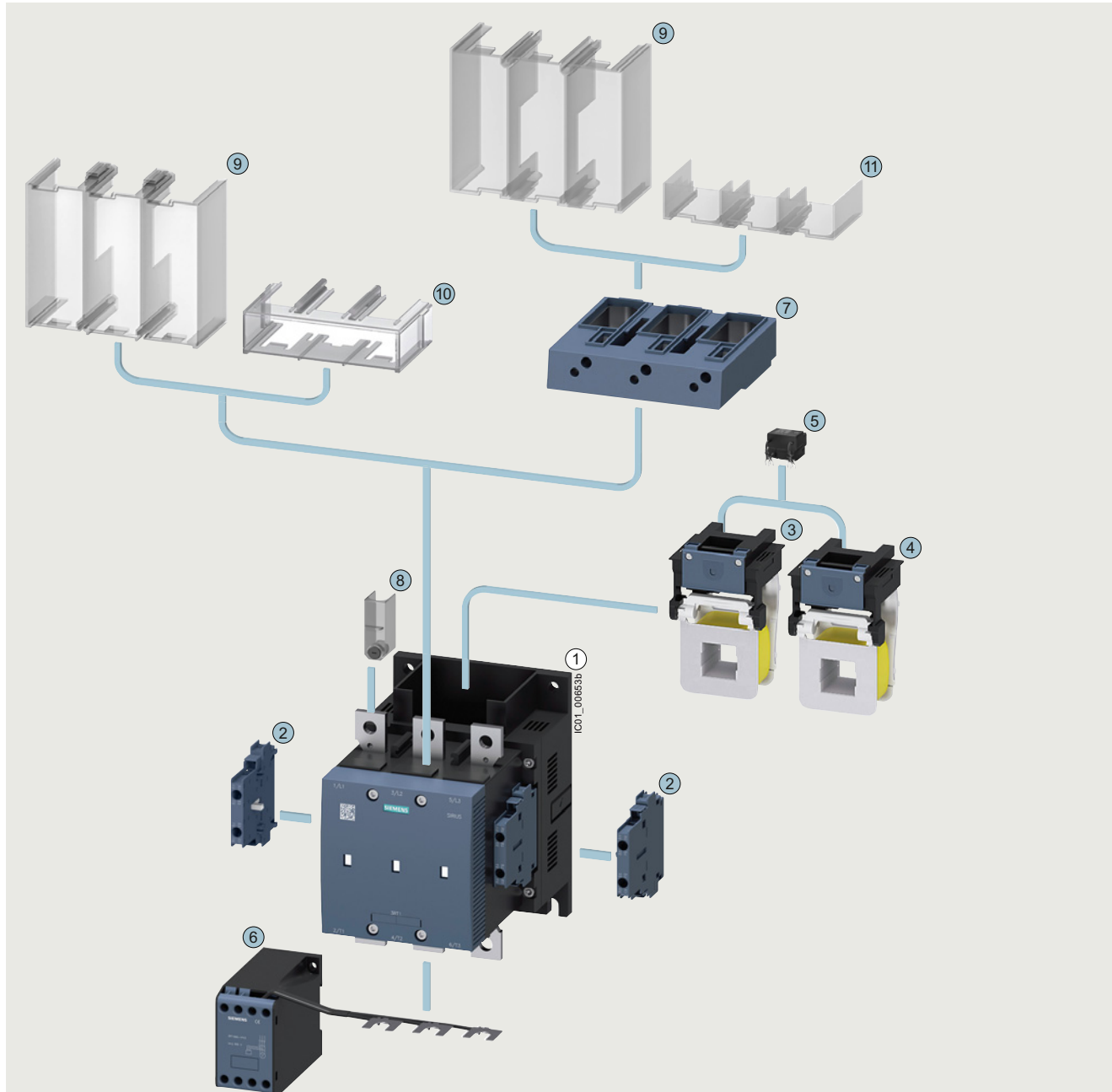

- ① 3RT126 vacuum contactor, size S10  
(version without withdrawable coil)

**Can be mounted onto side of contactor**

- ② 3RH192: 2-pole auxiliary switch

**Can be inserted in top of contactor**

- ③ 3RT1966-5A.3.: Withdrawable coil, standard operating mechanism  
④ 3RT1966-5N.3.: Withdrawable coil, solid-state operating mechanism

**Can be plugged onto top of contactor operating mechanisms**

- ⑤ 3RT1956-1C: Surge suppressor (RC element)

**Can be mounted at bottom on busbars**

- ⑥ 3RT1966-1PV.: Main current path surge suppression module

**Can be mounted onto the top or bottom on busbars or box terminals**

- ⑦ 3RT1966-4G: Box terminal block  
⑧ 3TX6546-3B: Terminal cover (can be screwed on), covers one busbar connection  
⑨ 3RT1966-4EA1: Terminal cover for busbar connection and on box terminal  
⑩ 3RT1966-4EA3: Terminal cover for busbar connection  
⑪ 3RT1966-4EA2: Terminal cover on box terminal

Accessories and spare parts, see pages 3/69 to 3/119 and 3/133 to 3/137.



# Switching devices – Contactors and contactor assemblies – for switching motors

## Power contactors for switching motors

General data

### 3RT107 and 3RT147 contactors · Size S12 with mountable accessories

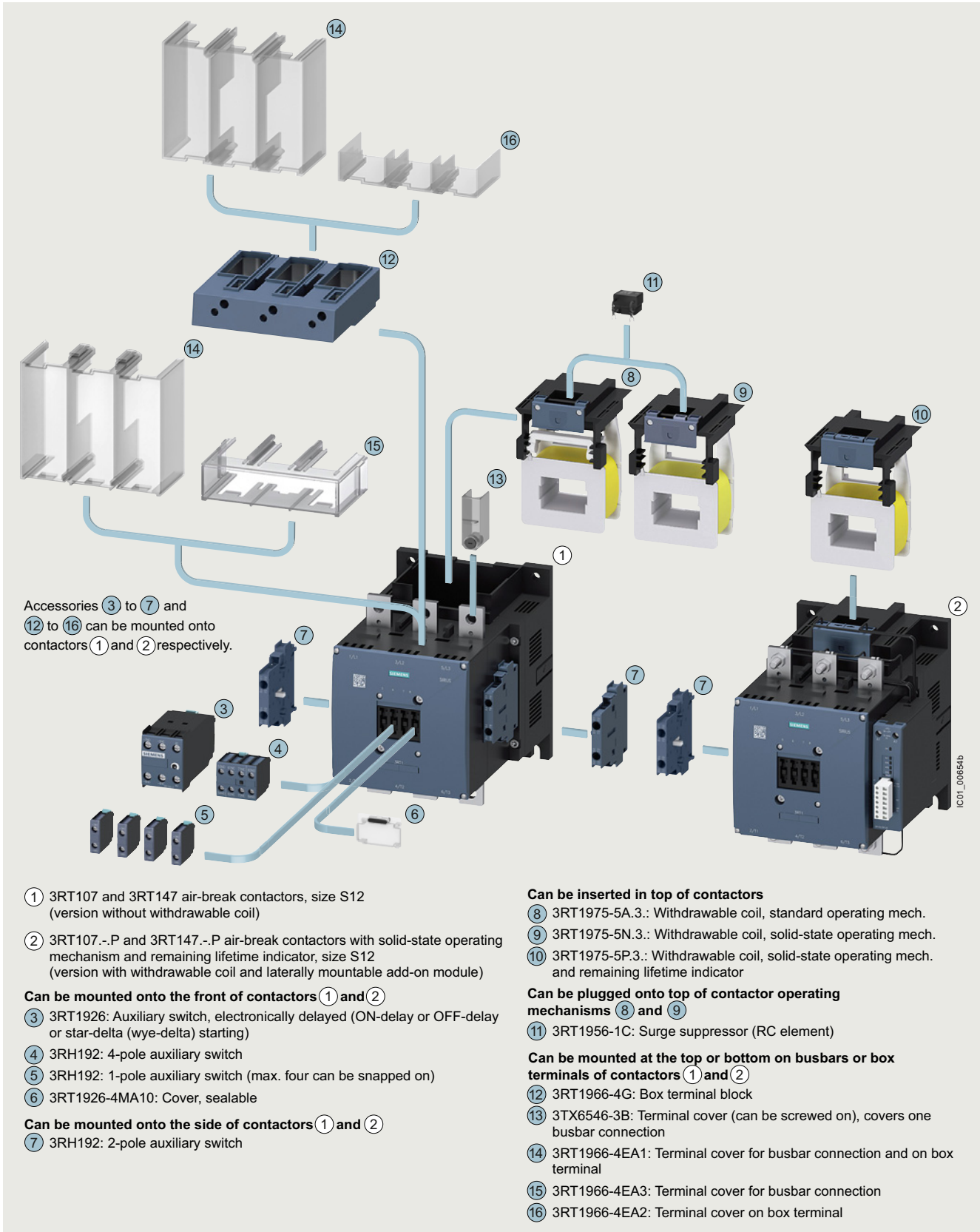

Accessories and spare parts, see pages 3/69 to 3/119.

## Switching devices – Contactors and contactor assemblies – for switching motors

### Power contactors for switching motors

#### General data

#### 3RT127 vacuum contactors · Size S12 with mountable accessories

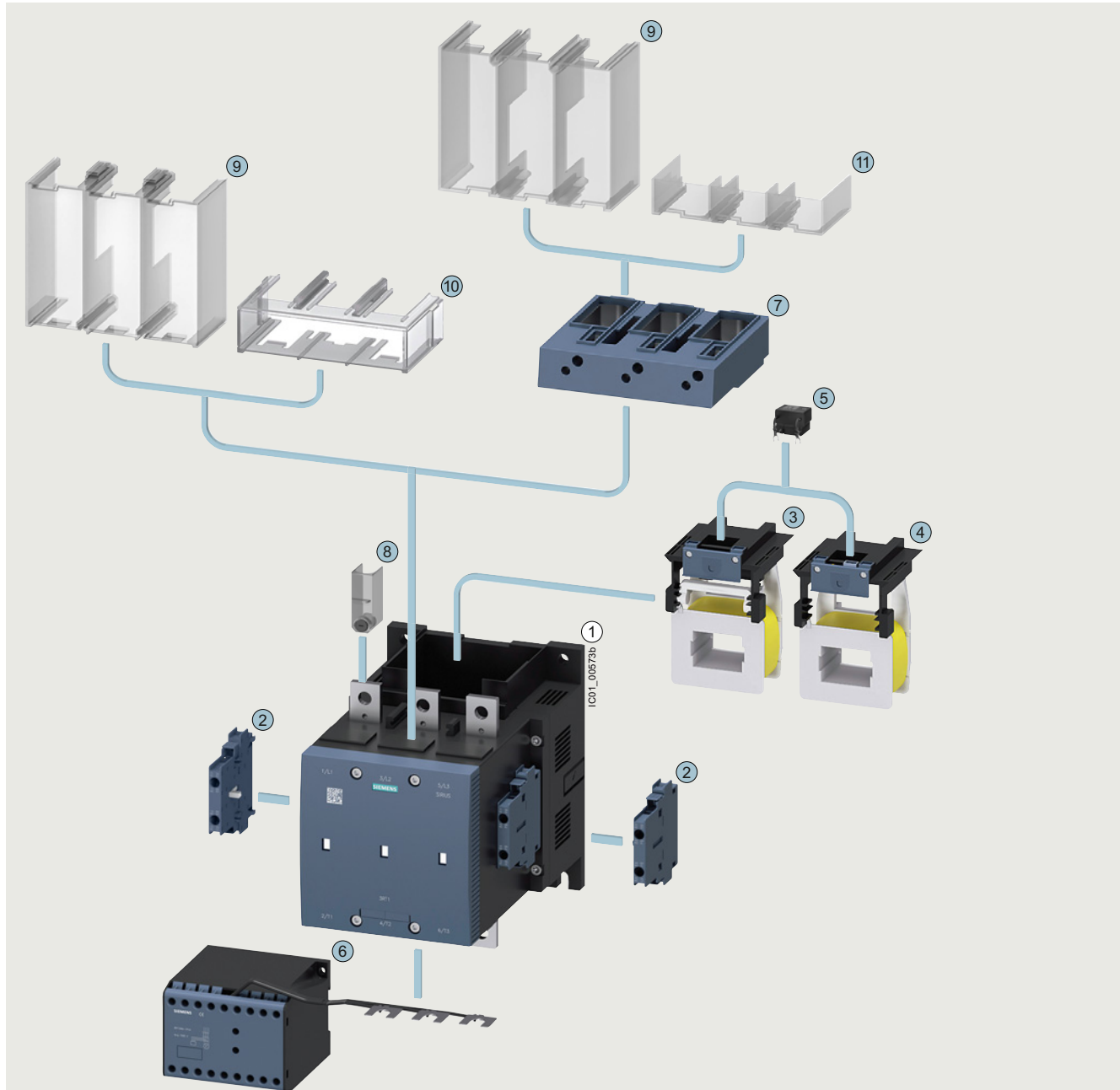

- ① 3RT127 vacuum contactor, size S12  
(version without withdrawable coil)

**Can be mounted onto the side of contactor**

- ② 3RH192: 2-pole auxiliary switch

**Can be inserted in top of contactors**

- ③ 3RT1975-5A.3.: Withdrawable coil, standard operating mechanism  
④ 3RT1975-5N.3.: Withdrawable coil, solid-state operating mechanism

**Can be plugged onto the top of contactor operating mechanisms**

- ⑤ 3RT1956-1C: Surge suppressor (RC element)

**Can be mounted at bottom on busbars**

- ⑥ 3RT1966-1PV.: Main current path surge suppression module

**Can be mounted at the top or bottom on busbars or box terminals**

- ⑦ 3RT1966-4G: Box terminal block  
⑧ 3TX6546-3B: Terminal cover (can be screwed on), covers one busbar connection  
⑨ 3RT1966-4EA1: Terminal cover for busbar connection and on box terminal  
⑩ 3RT1966-4EA3: Terminal cover for busbar connection  
⑪ 3RT1966-4EA2: Terminal cover on box terminal

Accessories and spare parts, see pages 3/69 to 3/119 and 3/133 to 3/137.

# Switching devices – Contactors and contactor assemblies – for switching motors

## Power contactors for switching motors

General data

### 3TF68 and 3TF69 vacuum contactors · Size S14 with mountable accessories

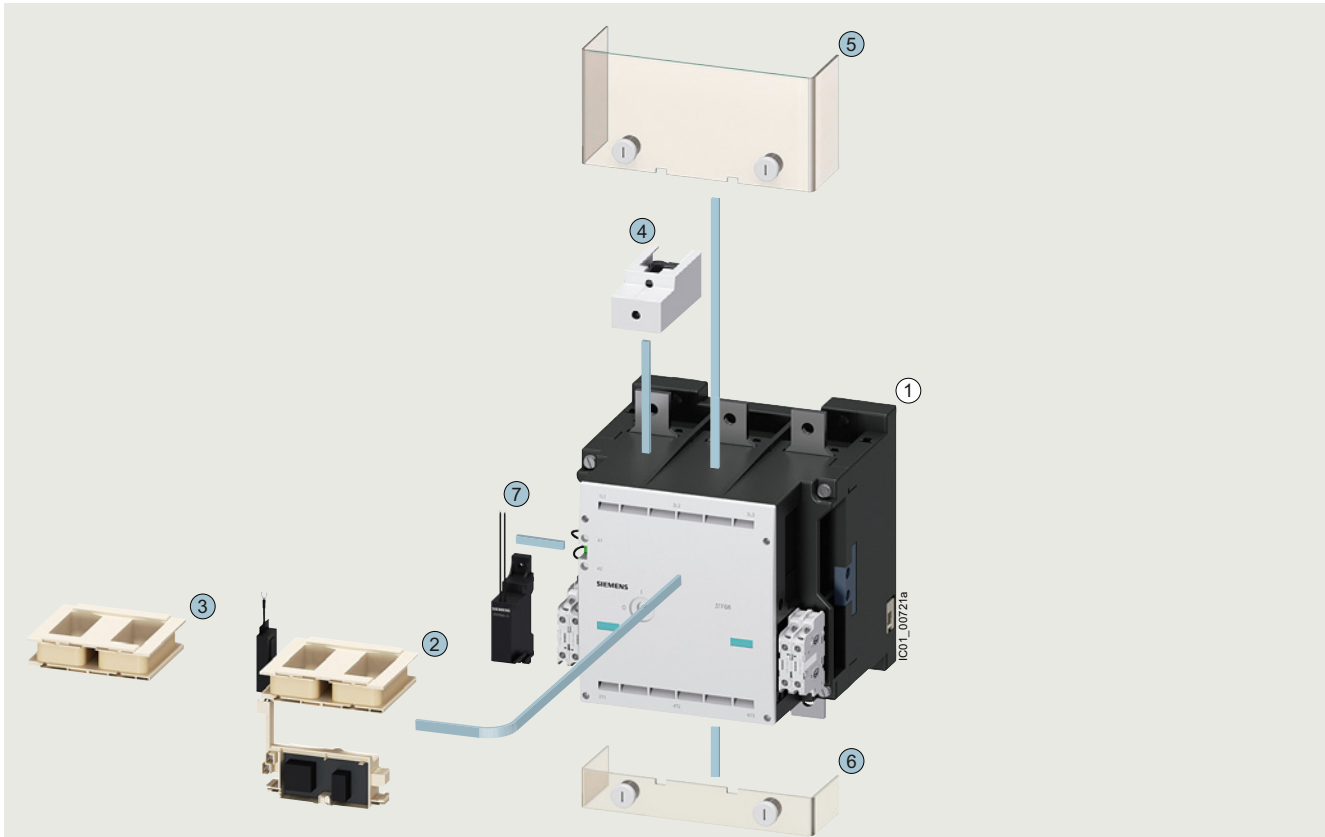

① 3TF68 and 3TF69 vacuum contactors, size 14

**Can be inserted or mounted on the front of the contactor (with the cover removed)**

- ② Solenoid coils for AC operation, with switch-on electronics for contactor  
 3TF6844-.C: 3TY7683-0C.7  
 3TF6944-.C: 3TY7693-0C.7
- ③ Solenoid coils for AC control supply voltage subject to strong interference  
 3TF6833-.Q: 3TY7683-0Q.7  
 3TF6933-.Q: 3TY7693-0Q.7
- Solenoid coils for DC operation  
 3TF6833-.D: 3TY7683-0D.4

**Can be mounted on the front from above or below on busbars**

- ④ Box terminal (1 set = 3 units)  
 3TF68: 3TX7570-1E  
 3TF69: 3TX7690-1F
- ⑤ Terminal cover for busbar connection (1 set = 2 units), attached to the right and left busbar connection in each case  
 3TF68: 3TX7686-0A  
 3TF69: 3TX7696-0A

**Can be mounted on the front of 3TF68 contactors from below on busbars**

- ⑥ Terminal cover for busbar connection (on outgoing side in combination with overload relay)  
 3TF68: 3TX7686-0B

**Can be snapped onto the left-hand side of the auxiliary switches**

- ⑦ Surge suppressor (only with DC operation)  
 3TF6.33-.D: 3TX7572-3.

Accessories and spare parts, see pages 3/133 to 3/137.

# Switching devices – Contactors and contactor assemblies – for switching motors

## Power contactors for switching motors

### SIRIUS 3RT contactors, 3-pole up to 250 kW

#### Overview

Version	Size	Ratings of three-phase motors at 50 Hz and 400 V kW	Connection methods Screw terminals	Spring-loaded terminals	Type	Page
<b>Power contactors for switching motors</b>						
<b>AC operation</b>						
<b>Basic unit</b> • With permanently mounted auxiliary switch • With permanently mounted auxiliary switch and varistor plugged into the front	S00	3 ... 7.5	✓	✓	3RT201.-.A.0. 3RT201.-.AP04-3MA0 3RT201.-.CP04-3MA0	3/47 3/47 3/47
<b>Basic unit</b> • With removable auxiliary switch • With permanently mounted auxiliary switch and varistor plugged in	S0	4 ... 18.5	✓	✓	3RT202.-.A.00 3RT202.-.A.04 3RT202.-.CL24-3MA0	3/48 3/49 3/49
<b>Basic unit</b> • With removable auxiliary switch • With permanently mounted auxiliary switch and integrated coil circuit	S2	18.5 ... 37	✓	✓	3RT203.-.A.00 3RT203.-.1A.04 3RT203.-.CL24-3MA0	3/50 3/50 3/50
<b>Basic unit</b> • With removable auxiliary switch • With permanently mounted auxiliary switch and integrated coil circuit	S3	37 ... 55	✓	✓	3RT20.-.A.00 3RT204.-.1A.04 3RT204.-.1CL24-3MA0	3/51 3/51 3/51
<b>DC operation</b>						
<b>Basic unit</b> • With integrated coil circuit • With permanently mounted auxiliary switch • With permanently mounted auxiliary switch and integrated coil circuit • With voltage tap-off	S00	3 ... 7.5	✓	✓	3RT201.-.B.4. 3RT201.-..B4. 3RT201.-.BB44-3MA0 3RT201.-.FB44-3MA0	3/52 3/52 3/53 3/53
<b>Basic unit</b> • With coil circuit plugged into front • With removable auxiliary switch • With permanently mounted auxiliary switch and integrated coil circuit • With voltage tap-off	S0	4 ... 18.5	✓	✓	3RT202.-.B.40 3RT202.-..B40 3RT202.-.BB44 3RT202.-..B44-3MA0	3/56 3/56 3/56 3/57
<b>DC operation for direct control by PLC (coupling contactors)</b>						
<b>Basic unit</b>	S00	3 ... 5.5	✓	✓	3RT201.-..B4.	3/54
<b>Basic unit with integrated coil circuit</b>	S00	3 ... 5.5	✓	✓	3RT201.-..B4.	3/54, 3/55
	S0	4 ... 15	✓	✓	3RT202.-.KB40	3/58
	S2	18.5 ... 37	✓	✓	3RT203.-.KB40	3/59
	S3	37 and 45	✓	✓	3RT204.-.KB40	3/59
<b>AC/DC operation (50/60 Hz AC or DC)</b>						
<b>Basic unit with integrated coil circuit</b>	S0	5.5 ... 18.5	✓	✓	3RT202.-.N.30	3/60
<b>Basic unit with integrated coil circuit</b> • With removable auxiliary switch • With permanently mounted auxiliary switch • With voltage tap-off • With fail-safe 24 V DC control signal input for safety-related applications up to SIL 3	S2	18.5 ... 37	✓	✓	3RT203.-.N.30 3RT203.-.1N.34 3RT203.-.NB34-3MA0 3RT203.-.NB30-0CC0	3/61 3/61 3/61 3/61
<b>Basic unit with integrated coil circuit</b> • With removable auxiliary switch • With permanently mounted auxiliary switch • With voltage tap-off • With fail-safe 24 V DC control signal input for safety-related applications up to SIL 3	S3	37 ... 55	✓	✓	3RT204.-.N.30 3RT204.-.1N.34 3RT204.-.NB34-3MA0 3RT204.-.NB30-0CC0	3/63 3/63 3/63 3/63
<b>Basic unit with integrated coil circuit</b> • Standard operating mechanism for AC and DC operation • Solid-state operating mechanism with the option of control via a separate 24 V DC control signal input - Fail-safe control signal input for safety-related applications up to SIL 3 - Standard control signal input - Standard control signal input, with remaining lifetime indicator (RLT)	S6 ... S12	55 ... 250	✓ <sup>1)</sup>	✓	3RT10.-.A.36	3/64
	S6 ... S12	55 ... 250	✓ <sup>1)</sup>	--	3RT10.-.S.36	3/65
			✓ <sup>1)</sup>	✓	3RT10.-.N.36	3/66
			✓ <sup>1)</sup>	--	3RT10.-.P.35	3/66

-- Version not possible

✓ Version possible

<sup>1)</sup> Connection method:

- Main circuit: Busbar connection (optionally with box terminals),

- Auxiliary/control circuit: Screw terminals or spring-loaded terminals.

## Switching devices – Contactors and contactor assemblies – for switching motors

### Power contactors for switching motors

SIRIUS 3RT contactors, 3-pole up to 250 kW



Contactors with screw terminals: 3RT20 (sizes S00 to S3) and 3RT10 (sizes S6 to S12)

Our power range of contactors for switching IE2 motors and highly efficient IE3 and IE4 motors:

- Contactors, [see pages 3/47 to 3/66](#):
  - Size S00: 3RT201 up to 7.5 kW
  - Size S0: 3RT202 up to 18.5 kW
  - Size S2: 3RT203 up to 37 kW
  - Size S3: 3RT204 up to 55 kW
  - Sizes S6 to S12: 3RT10 up to 250 kW
- Vacuum contactors, [see page 3/120 onwards](#):
  - Sizes S10 and S12: 3RT12 up to 250 kW
  - Size 14: 3TF6 up to 450 kW

#### Standards

IEC 60947-1, IEC 60947-4-1, IEC 60947-5-1 (auxiliary switches)

#### Contactors with increased tamper protection

Increased tamper protection is ensured either by using our contactor versions with factory-installed, permanently mounted auxiliary switches protected against mechanical external actuation (e.g. 3RT20...-3MA0 or 3RT10...-3PA0 contactors), or by using the 3RT2916-4MA10 or 3RT1926-4MA10 sealable cover as an accessory ([see page 3/112](#)).

## Switching devices – Contactors and contactor assemblies – for switching motors

### Power contactors for switching motors

#### SIRIUS 3RT contactors, 3-pole up to 250 kW

##### Operating times

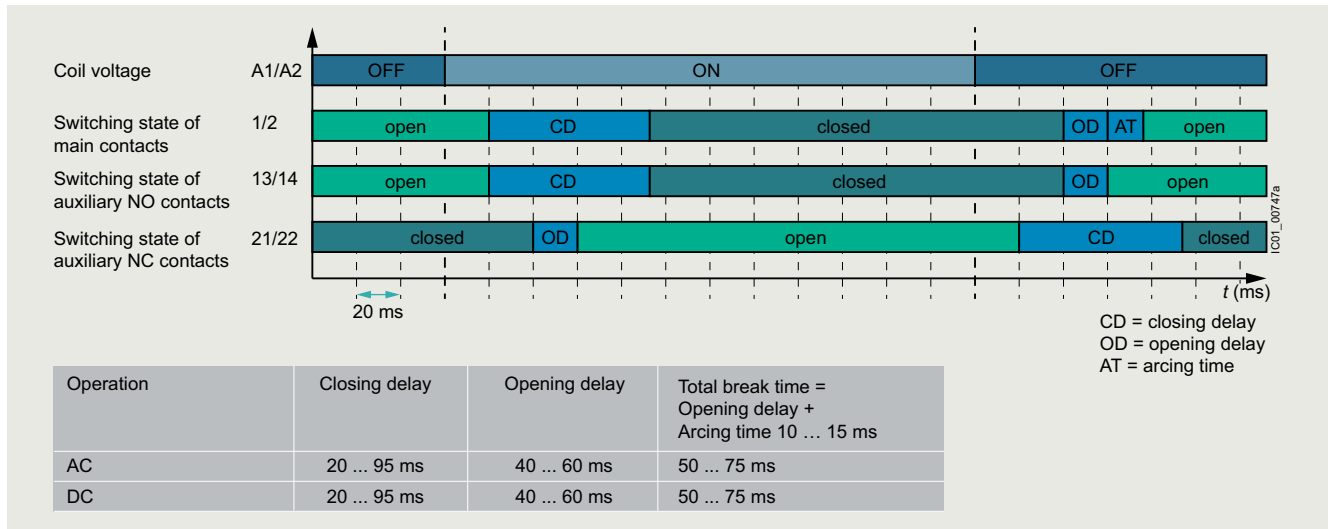

Operating times using the example of contactor 3RT1054-1AB36

##### **Protection of the device connections from short circuit, overload and overvoltage**

Appropriate steps must always be taken to protect device connections from overload and short circuit. There are different constraints depending on the type of connection:

###### Protection of main terminals from short circuit and overload

For information about protection of a single contactor, see the [technical product data sheet](#).

For more information on complete units such as contactors with overload relays or contactors with motor starter protectors as the motor feeder, see [Configuration Manual for load feeders](#).

###### Protection of auxiliary connections from short circuit and overload

For information about protection of auxiliary contacts, see the [technical product data sheet](#).

###### Protection of control supply voltage or supply voltage connections from short circuit and overload

First of all, the relevant standards and regulations for configuring control panels and the parts and components installed in them must be taken into account, for example when dimensioning the cables.

One possible protection for these circuits could be the selection of a suitable power supply, i.e. one with a current-limiting function. In the selection of the source and the connecting cable, the load characteristics of the contactor must be considered (short-time inrush current peaks for solid-state contactor operating mechanisms, closing, closed).

If there are further switching elements in the circuits, such as the auxiliary contact system of an overload relay that operates the contactor, the short-circuit protection necessary for this must also be considered.

For further recommendations, e.g. the use of miniature circuit breakers or circuit breakers for equipment in control circuits, see [Control panel tip – Fast, reliable selection and dimensioning of an appropriate power supply unit](#).

###### Protection of contactors with digital input from short circuit and overload

For the PLC input types according to IEC 60947-4-1 these inputs have a typical rated current of 20 mA. These inputs can be protected accordingly.

- Contactors with PLC and F-PLC inputs:
  - For 3RT10...-P marked with IN+/IN-
  - For 3RT10...-S, -.N and 3RT20...-S marked with +/-
- Supply voltage connections A1 - A2:
  - For 3RT10...-N, -.P and 3RT20...-S, protection should be provided on the basis of the load characteristics. For information about power consumption, see the [technical product data sheet](#).
  - For 3RT10...-S, protection is already integrated.

###### Protection of other connections from short circuit and overload

The contactor version 3RT10...-P with remaining lifetime indicator (RLT) has additional connections H1 - H2 and R1 - R2.

If A1 - A2 is already protected, further protection of H1 - H2 is not required.

For information about protection of R1 - R2, see the [technical product data sheet](#).

###### Overvoltage protection at the control supply voltage connection

3RT20 contactors supplied without a coil circuit can be retrofitted with RC elements, varistors, diodes or diode assemblies (combination of diode and Zener diode for short break times) for damping switching overvoltages in the coil and can be ordered separately as accessories, see [page 3/97 onwards](#).

The 3RT10 contactors are already equipped with coil damping (varistor).

###### Note:

The break times of the contactor, the opening delay times of the NO contacts and the closing delay times of the NC contacts increase with damping.

For more detailed information about how damping affects the time response, see [Equipment Manual](#).



# Switching devices – Contactors and contactor assemblies – for switching motors

## Power contactors for switching motors

### SIRIUS 3RT contactors, 3-pole up to 250 kW

#### Connection methods

##### Main circuit

- 3RT201 and 3RT202 contactors:  
Screw terminals or spring-loaded terminals;  
spring-loaded terminals with convenient plug-in design for device connectors
- 3RT203 and 3RT204 contactors:  
Screw terminals with box terminal;  
direct connection to the connecting bar is possible with cable lugs for 3RT204 when the box terminal is removed.
- 3RT10 contactors:  
Screw terminals with connecting bars that the cables can be connected to using either cable lugs or flexible or rigid busbars. Alternatively, box terminals are available as accessories.

##### Auxiliary and control circuits

The 3RT contactors are available with screw terminals or spring-loaded terminals.

#### Electromagnetic compatibility

The contactors fulfill the requirements for environment category A.

##### Note:

When the contactors are used in an **environment with frequency converters**, the configuration notes must be observed, [see Equipment Manual](#).

#### Contact reliability of the auxiliary contacts

If voltages  $\leq 110$  V and currents  $\leq 100$  mA are to be switched, the auxiliary contacts of the 3RT contactors or 3RH contactor relays should be used as they guarantee a high level of contact reliability.

These auxiliary contacts are particularly suitable for solid-state circuits with currents  $\geq 1$  mA at a voltage  $\geq 17$  V.

#### Motor protection

##### 3RT20 contactors

For protection against overload, 3RU2 thermal overload relays ([see page 7/89 onwards](#)) or 3RB3 electronic overload relays ([see page 7/102 onwards](#)) can be mounted on the 3RT20 contactors.

##### 3RT10 contactors

For protection against overload, 3RB2 electronic overload relays ([see page 7/114 onwards](#)) can be mounted on the 3RT10 contactors.

#### Plant and application monitoring

For monitoring and measuring in the application, 3RR2 monitoring relays can be mounted on the 3RT20 contactors ([see page 10/47](#)).

#### Contactors with voltage tap

The 3RT20 contactors with voltage tap-off are special versions for mounting the SIRIUS 3RA27 function modules for connection to the control system via IO-Link or AS-Interface ([see page 3/73 onwards](#)).

Without a function module, these contactors can be used like the standard versions.

For more information on IO-Link and AS-Interface, [see "Industrial communication", page 2/1 onwards](#).

#### Operating mechanism types

##### 3RT20 contactors

The standard versions are available with AC or DC operating mechanisms or as versions with a wide-range solid-state operating mechanism and a universal actuating voltage (AC or DC operation possible).

Versions with solid-state operating mechanisms for AC or DC operation with a fail-safe PLC input are also available for the 3RT203 and 3RT204 contactors.

Control takes place via the control supply voltage connection A1 - A2 with varying operating ranges ([see the technical product data sheet](#) for further details).

DC coupling contactors with reduced power consumption are also ideally suited for connection to the controller.

##### 3RT10 contactors

The operating mechanisms are powered via a supply voltage with an operating range from 0.8 to  $1.1 \times U_s$ , optionally also controlled depending on the chosen mode of operation. Various rated voltage ranges are available for AC/DC control.

The following control and/or operating mechanism versions can be selected for contactors 3RT105 to 3RT107:

- 3RT10..-A contactors:  
Standard operating mechanism for AC and DC operation (reduced power consumption when closing and in the closed state)
- Solid-state operating mechanisms:  
Overvoltage damping of the operating mechanism coil is already integrated in the electronics for contactors with solid-state operating mechanisms.  
The following versions are available:
  - 3RT10..-N contactors:  
With two operating modes: Direct control or via PLC input (24 V DC)
  - 3RT10..-P contactors:  
Control via PLC input (24 V DC) only, but with additional remaining lifetime indicator (RLT)
  - 3RT10..-S contactors:  
Control via fail-safe PLC input (24 V DC) only, for simplification of safety applications (without mode of operation selection)

## Switching devices – Contactors and contactor assemblies – for switching motors

### Power contactors for switching motors

#### SIRIUS 3RT contactors, 3-pole up to 250 kW

##### **Replacing solenoid coils, operating mechanisms or spare contacts**

###### 3RT20 contactors

Coil replacement is possible for contactors 3RT202 to 3RT204.

###### NOTICE:

Removal or changing of the operating mechanism or spare contacts is not permitted for 3RT20...S contactors with fail-safe control.

###### 3RT10 contactors

The operating mechanisms for 3RT10...A/-N/-P contactors are removable and can be replaced simply by unlocking and pulling them out.

###### NOTICE:

Removal or changing of the operating mechanism is not permitted for 3RT10...S contactors with fail-safe control.

##### **Fitting auxiliary contacts and mounting additional auxiliary switches**

###### Features in the delivery state

- 3RT20 contactors:
  - 3RT201 contactors:
    - An auxiliary contact is integrated in the basic unit.
  - Contactors 3RT202 to 3RT204:
    - The basic units contain two integrated auxiliary contacts (1 NO + 1 NC).
- 3RT10 contactors:
  - These contactors are supplied with two laterally mounted auxiliary switches. The fitting of auxiliary switches is possible on the front and on the side.

###### Expansion possibilities

All basic units (with the exception of coupling contactors in sizes S00 and S0) can be expanded using auxiliary switches. The permitted configuration must be taken into account.

For detailed information about the fitting of auxiliary switches for 3RT20 contactors, see [pages 3/81 to 3/86](#).

## Switching devices – Contactors and contactor assemblies – for switching motors

### Power contactors for switching motors

SIRIUS 3RT contactors, 3-pole up to 250 kW

#### Connection of contactors to fail-safe control modules

While contactors with smaller power ratings can be connected directly to the outputs of fail-safe controllers, implementing safety-related applications with standard contactors with higher power is much more complicated and elaborate because of the necessary coupling links.

Due to their fail-safe control input, special contactors provide a much simpler way of doing this:

- 3RT20...-S contactors in sizes S2 and S3
- 3RT10...-S contactors in sizes S6 to S12

For more information, see

- Safety technology, page 11/1 onwards
- Guide of use for contactors in safety applications

Example for SIL 2 and SIL 3/PL e application – previously:

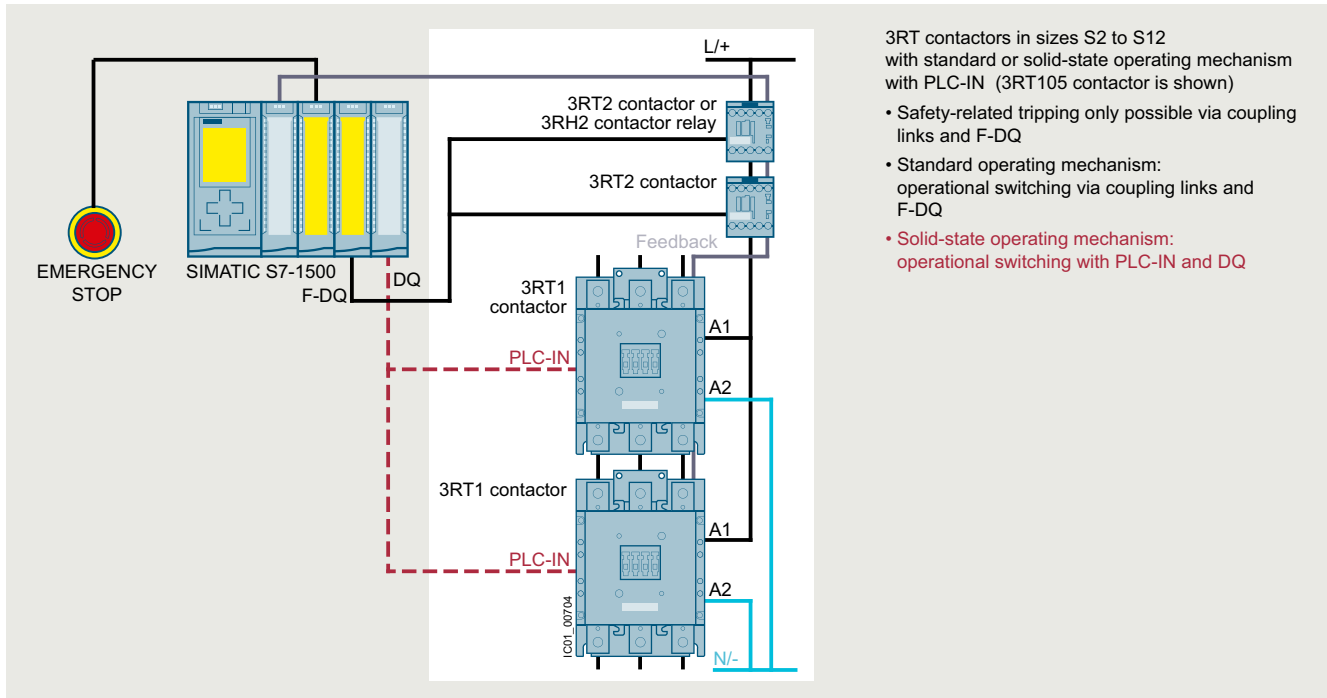

Application with safety-related disconnection with standard contactors using the example of a 3RT105 contactor

Example for SIL 3/PL e (left-hand side) or SIL 2/PL c (right-hand side) application – new:

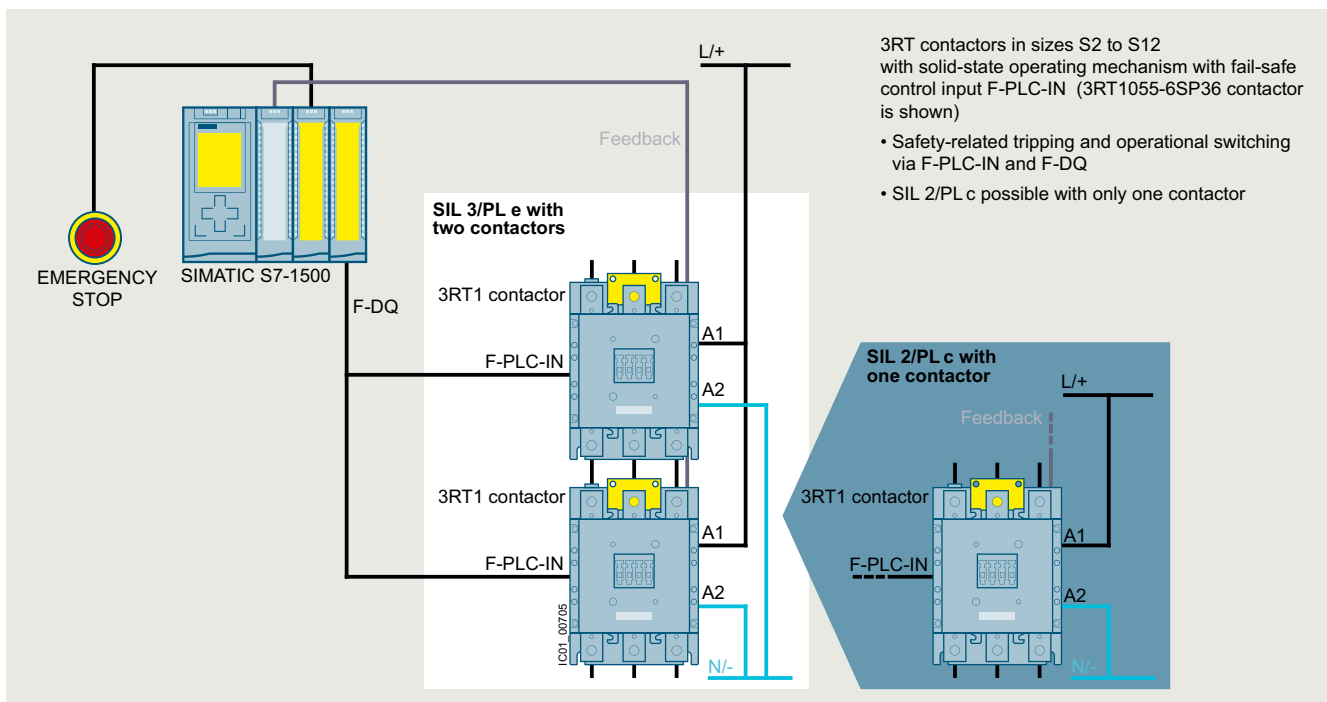

Application with safety-related disconnection with contactors with fail-safe control using the example of a 3RT105 contactor

## Switching devices – Contactors and contactor assemblies – for switching motors

### Power contactors for switching motors

#### SIRIUS 3RT contactors, 3-pole up to 250 kW

##### Contactors for special applications

- SIRIUS 3RT.4 contactors for low or non-inductive loads (AC-1), 3-pole, [see page 4/7 onwards](#)
- SIRIUS 3RT20 and 3RT10 contactors with an extended application range, 3-pole (for railway applications), [see page 4/54 onwards](#)

##### Article number scheme

Product versions	Article number
<b>SIRIUS power contactors</b>	<b>3RT2</b> □ □ □ - □ □ □ □ □ - □ □ □ □
Device type	e.g. 0 = 3-pole motor contactor □
Size of the contactor	e.g. 4 = S3 □
Rating dependent on size	e.g. 5 = 37 kW for S3 □
Type of electrical connection	e.g. 1 = screw terminals (main and auxiliary circuits) □
Operating range/solenoid coil circuit	e.g. A = AC standard/without coil circuit □
Rated control supply voltage	e.g. P0 = 230 V AC, 50 Hz □ □
Auxiliary switches	e.g. 0 = for S3: 1 NO + 1 NC integrated □
Special version	□ □ □ □
Example	<b>3RT2 0 4 5 - 1 A P 0 0</b>

##### Note:

The article number scheme shows an overview of product versions for better understanding of the logic behind the article numbers.

For your orders, please use the article numbers quoted in the selection and ordering data.

# Switching devices – Contactors and contactor assemblies – for switching motors

## Power contactors for switching motors

### SIRIUS 3RT contactors, 3-pole up to 250 kW

#### Technical specifications

##### More information

Technical specifications, see  
<https://support.industry.siemens.com/cs/ww/en/ps/16134/td>  
 FAQs, see  
<https://support.industry.siemens.com/cs/ww/en/ps/16134/faq>

System Manual for modular system, see  
<https://support.industry.siemens.com/cs/ww/en/view/60311318>  
 Equipment Manual, see  
<https://support.industry.siemens.com/cs/ww/en/view/60306557>  
 Application Manual - Switching devices with IE3 and IE4 motors, see  
<https://support.industry.siemens.com/cs/ww/en/view/94770820>  
 Configuration Manual for load feeders, see  
<https://support.industry.siemens.com/cs/ww/en/view/39714188>  
 Configuration Manual for UL, see  
<https://support.industry.siemens.com/cs/ww/en/view/53433538>  
 Guide of use for contactors in safety applications, see  
<https://support.industry.siemens.com/cs/ww/en/view/109807687>

Type	Contactors			
Size	3RT2		S3	3RT1
	S00 to S2			S6 to S12
<b>Rated data of the auxiliary contacts</b>				
<b>According to IEC 60947-5-1</b>				
Data apply to integrated auxiliary contacts and conventional contacts in the auxiliary switches				
<b>Rated insulation voltage <math>U_i</math></b> (pollution degree 3)	V	690	1 000 (3RT20...0CC0: 690)	--
• For laterally mountable auxiliary switches	V	690	690	500
• For front auxiliary switches	V	690	690	690
<b>Conventional thermal current <math>I_{th}</math> = rated operational current <math>I_e/AC-12</math></b>	A	10		
<b>AC load</b>				
<b>Rated operational current <math>I_e/AC-15/AC-14</math></b>				
• At rated operational voltage $U_e$	Up to 230 V	A	10 <sup>1)</sup>	6
	400 V	A	3	6
	500 V	A	2	3
	690 V	A	1	2
				1 <sup>2)</sup>
<b>DC load</b>				
<b>Rated operational current <math>I_e/DC-12</math></b>				
• At rated operational voltage $U_e$	24 V	A	10	10
	60 V	A	6	6
	110 V	A	3	3
	125 V	A	2	2
	220 V	A	1	1
	440 V	A	0.3	0.3
	600 V	A	0.15	0.15 <sup>2)</sup>
<b>Rated operational current <math>I_e/DC-13</math></b>				
• At rated operational voltage $U_e$	24 V	A	10 <sup>1)</sup>	10 <sup>3)</sup>
	60 V	A	2	2
	110 V	A	1	1
	125 V	A	0.9	0.9
	220 V	A	0.3	0.3
	440 V	A	0.14	0.14
	600 V	A	0.1	0.15 <sup>2)</sup>
<b>Contact reliability at 17 V, 1 mA</b>	Frequency of contact faults < 10 <sup>-8</sup> i.e. < 1 fault per 100 million operating cycles			
According to IEC 60947-5-4				

<sup>1)</sup> 3RH22, 3RH29, 3RT2...-...4, 3RT2...-...6:  $I_e = 6$  A at AC-15/AC-14 and DC-13.

<sup>2)</sup> With laterally mountable auxiliary switches, only the currents for rated operational voltages up to 500 V apply.

<sup>3)</sup> For laterally mountable auxiliary switches, DC-13/at 24 V: max. 6 A.

# Switching devices – Contactors and contactor assemblies – for switching motors

## Power contactors for switching motors

### SIRIUS 3RT contactors, 3-pole up to 250 kW

Type

3RT contactors

Size

S00 to S12

#### Electrical endurance of auxiliary contacts

It is assumed that the operating mechanisms are switched arbitrarily and not synchronously with the phase angle of the supply system switching operating mechanism.

The electrical contact endurance is mainly dependent on the breaking current.

#### Sizes S00 to S3

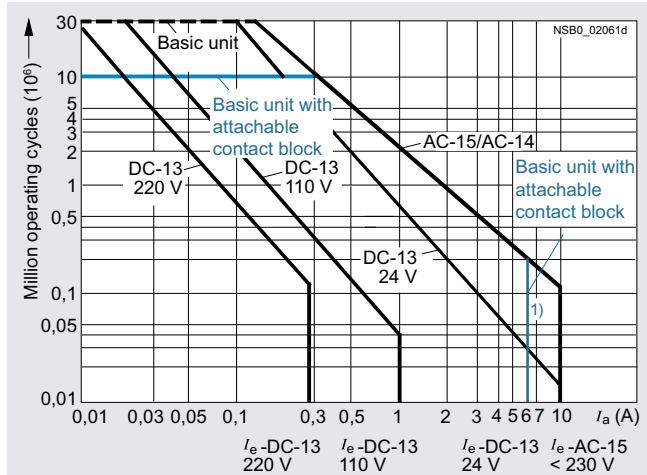

#### Sizes S6 to S12

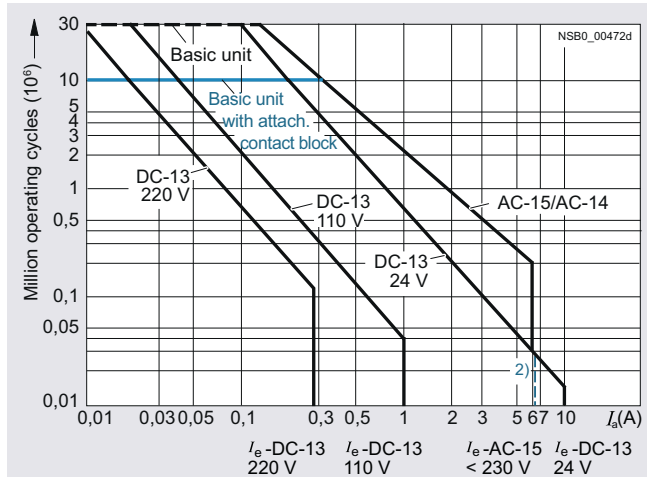

<sup>1)</sup> 3RH22, 3RH29, 3RT2...-...4, 3RT2...-...6:  $I_e = 6$  A at AC-15/AC-14 and DC-13, 3RT2.4:  $I_e = 6$  A at AC-15/AC-14.

<sup>2)</sup> For laterally mountable auxiliary switches, DC-13/at 24 V: max. 6 A.

<sup>3)</sup> With laterally mountable auxiliary switches, the currents for rated operational voltages up to 500 V apply.



# Switching devices – Contactors and contactor assemblies – for switching motors

## Power contactors for switching motors

### SIRIUS 3RT contactors, 3-pole up to 250 kW

Type **3RT2 contactors**  
 Size **S00 and S0**

#### Contact endurance of the main contacts

The characteristic curves show the contact endurance of the contactors when switching low inductive or non-inductive AC loads (AC-1) and motor-driven loads (AC-3 and AC-3e) depending on the breaking current and rated operational voltage. It is assumed that the operating mechanisms are switched arbitrarily and not synchronously with the phase angle of the supply system switching operating mechanism.

The rated operational current  $I_e$  complies with utilization category AC-4 (breaking 6 times the rated operational current) and is intended for a contact endurance of approximately 200 000 operating cycles.

If a shorter contact endurance is sufficient, the rated operational current  $I_e/AC-4$  can be increased.

If the contacts are used for mixed operation, i.e. normal switching (breaking the rated operational current according to utilization category AC-3 and AC-3e) in combination with intermittent inching (breaking several times the rated operational current according to utilization category AC-4), the contact endurance can be calculated approximately from the following equation:

$$X = \frac{A}{1 + \frac{C}{100} \left( \frac{A}{B} - 1 \right)}$$

Characters in the equation:

- X Contact endurance for mixed operation in operating cycles
- A Contact endurance for normal operation ( $I_a = I_e$ ) in operating cycles
- B Contact endurance for inching ( $I_a = \text{multiple of } I_e$ ) in operating cycles
- C Inching operations as a percentage of total switching operations

#### Size S00

Operating cycles at

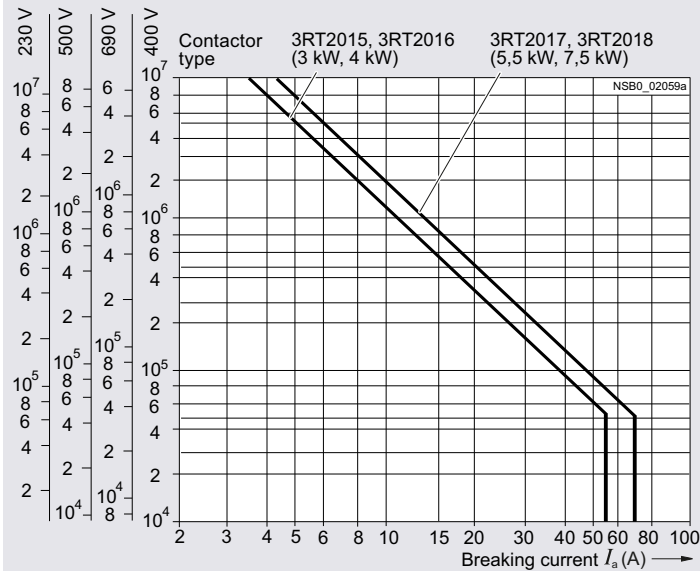

#### Size S0

Operating cycles at

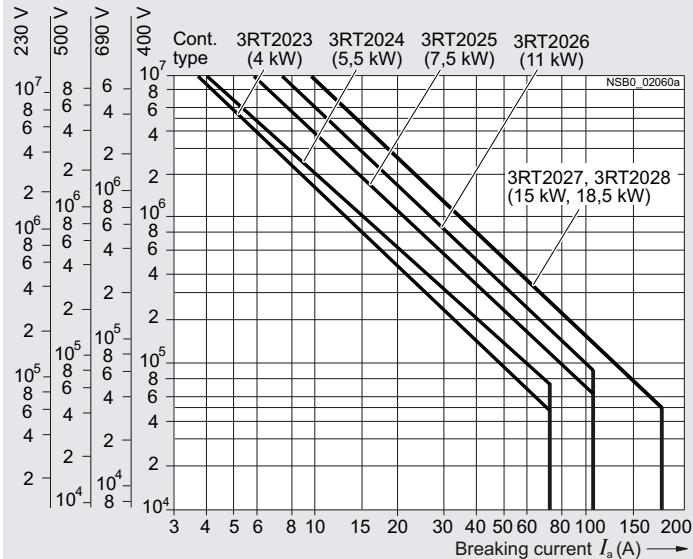

# Switching devices – Contactors and contactor assemblies – for switching motors

## Power contactors for switching motors

### SIRIUS 3RT contactors, 3-pole up to 250 kW

Type **3RT contactors**  
 Size **S2 to S12**

#### Contact endurance of main contacts (continued)

#### Size S2

Operating cycles at

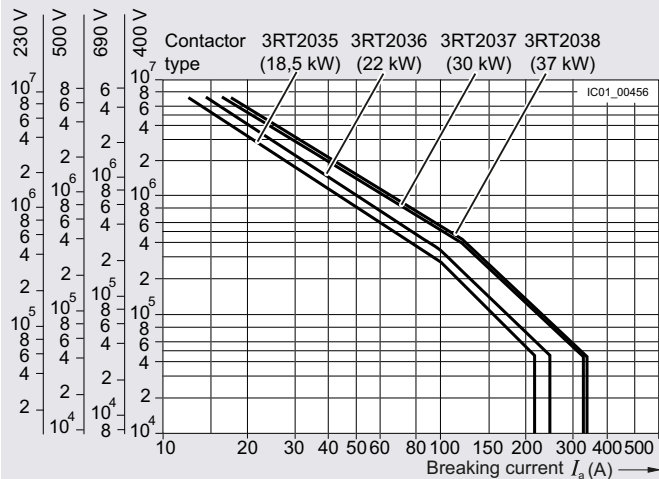

#### Size S3

Operating cycles at

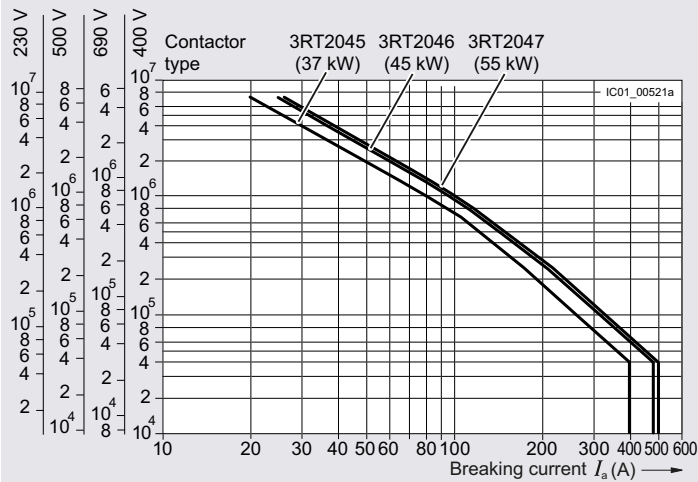

#### Sizes S6 to S12

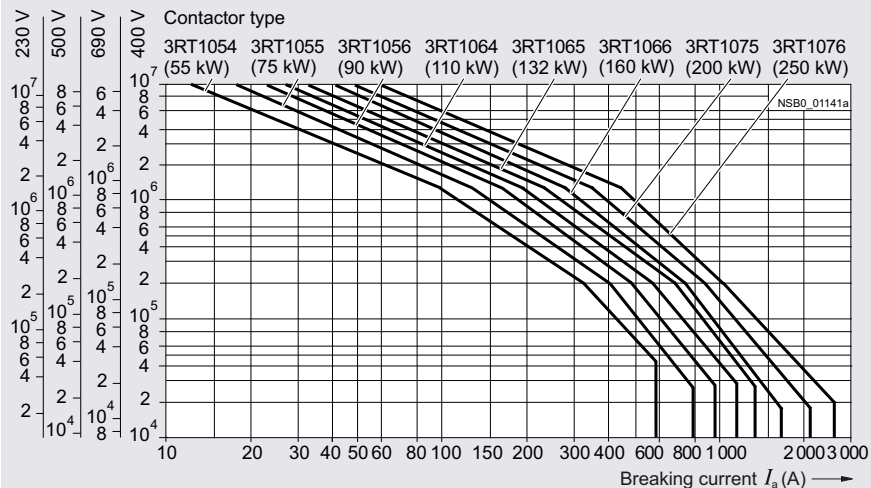

Operating cycles at



# Switching devices – Contactors and contactor assemblies – for switching motors

## Power contactors for switching motors

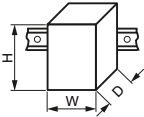
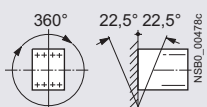
### SIRIUS 3RT contactors, 3-pole up to 250 kW

		<b>Contactors</b>	
Type		<b>3RT2015, 3RT2016</b>	<b>3RT2017, 3RT2018</b>
Size		<b>S00</b>	
<b>General data</b>			
<b>Dimensions (W x H x D)</b>			
<ul style="list-style-type: none"> <li>Basic unit               <ul style="list-style-type: none"> <li>Screw terminals</li> <li>Spring-loaded terminals</li> </ul> </li> <li>Basic unit with mounted auxiliary switch               <ul style="list-style-type: none"> <li>Screw terminals</li> <li>Spring-loaded terminals</li> </ul> </li> <li>Basic unit with mounted function module or solid-state time-delayed auxiliary switch               <ul style="list-style-type: none"> <li>Screw terminals</li> <li>Spring-loaded terminals</li> </ul> </li> </ul>		mm	45 x 58 x 73
		mm	45 x 70 x 73
		mm	45 x 58 x 117
		mm	45 x 70 x 121
		mm	45 x 58 x 147
		mm	45 x 70 x 147
<b>Permissible mounting position</b>			
The contactors are designed for operation on a vertical mounting surface.			
Upright mounting position		 Special version required	
<b>Mechanical endurance</b>			
<ul style="list-style-type: none"> <li>Basic unit</li> <li>- With mounted auxiliary switch</li> <li>- With solid-state compatible auxiliary switch</li> </ul>	Operating cycles	30 million	
	Operating cycles	10 million	
	Operating cycles	5 million	
<b>Electrical endurance</b>		For contact endurance of the main contacts, see page 3/27.	
<b>Rated insulation voltage <math>U_i</math></b> (pollution degree 3)	V	690	
<b>Rated impulse withstand voltage <math>U_{imp}</math></b>			
• Auxiliary circuit	kV	6	
• Main circuit	kV	6	
<b>Protective separation</b> between the coil and the main contacts according to IEC 60947-1, Annex N	V	400	
<b>Mirror contacts</b>			
A mirror contact is an auxiliary NC contact that cannot be closed simultaneously with an NO main contact.			
<ul style="list-style-type: none"> <li>3RT2.1 (removable auxiliary switch)</li> <li>3RH2919-.NF.. solid-state compatible auxiliary switches</li> </ul>		Yes, in the basic unit as well as between the basic unit and the mounted auxiliary switch according to IEC 60947-4-1 Annex F No mirror contact for size S00	
<b>Ambient temperature</b>			
• During operation	°C	-25 ... +60	
• During storage	°C	-55 ... +80	







# Switching devices – Contactors and contactor assemblies – for switching motors

## Power contactors for switching motors

### SIRIUS 3RT contactors, 3-pole up to 250 kW

		Contactors																																					
		3RT2015, 3RT2016	3RT2017, 3RT2018																																				
Type	Size	S00																																					
<b>Short-circuit protection</b>																																							
<b>Main circuit</b>																																							
<ul style="list-style-type: none"> <li>Fuse links, operational class gG: LV HRC, type 3NA; DIAZED, type 5SB; NEOZED, type 5SE according to IEC 60947-4-1           <ul style="list-style-type: none"> <li>Type of coordination "1" A 35 50</li> <li>Type of coordination "2" A 20 25</li> <li>Weld-free (test conditions according to IEC 60947-4-1) A 10</li> </ul> </li> <li>Miniature circuit breaker (up to 230 V) with C characteristic Short-circuit current 1 kA, type of coordination "1" A 10</li> </ul>																																							
<b>Auxiliary circuit</b>																																							
Short-circuit test according to IEC 60947-5-1																																							
<ul style="list-style-type: none"> <li>With fuse links, operational class gG: DIAZED, type 5SB; NEOZED, type 5SE with short-circuit current <math>I_k = 1</math> kA A 10</li> <li>With 230 V miniature circuit breaker, C characteristic with short-circuit current <math>I_k = 400</math> A A 6</li> </ul>																																							
Short-circuit protection for contactors with overload relays		See Configuration Manual for load feeders																																					
Short-circuit protection for fuseless load feeders		See 3RA2 load feeders, page 8/5 onwards																																					
<b>Control</b>																																							
<b>Solenoid coil operating range</b>																																							
<ul style="list-style-type: none"> <li>AC operation           <table border="0"> <tr> <td>50 Hz</td> <td>0.8 ... 1.1 x <math>U_s</math></td> </tr> <tr> <td>60 Hz</td> <td>0.85 ... 1.1 x <math>U_s</math></td> </tr> </table> </li> <li>DC operation           <table border="0"> <tr> <td><math>U_p</math> up to 50 °C</td> <td>0.8 ... 1.1 x <math>U_s</math></td> </tr> <tr> <td><math>U_p</math> up to 60 °C</td> <td>0.85 ... 1.1 x <math>U_s</math></td> </tr> </table> </li> </ul>				50 Hz	0.8 ... 1.1 x $U_s$	60 Hz	0.85 ... 1.1 x $U_s$	$U_p$ up to 50 °C	0.8 ... 1.1 x $U_s$	$U_p$ up to 60 °C	0.85 ... 1.1 x $U_s$																												
50 Hz	0.8 ... 1.1 x $U_s$																																						
60 Hz	0.85 ... 1.1 x $U_s$																																						
$U_p$ up to 50 °C	0.8 ... 1.1 x $U_s$																																						
$U_p$ up to 60 °C	0.85 ... 1.1 x $U_s$																																						
<b>Power consumption of the solenoid coils</b> (for cold coil and $1.0 \times U_s$ )																																							
<ul style="list-style-type: none"> <li>AC operation, 50/60 Hz, standard version           <table border="0"> <tr> <td>- Closing VA</td> <td>27/24.3</td> <td>37/33</td> </tr> <tr> <td>- P.f.</td> <td>0.8/0.75</td> <td></td> </tr> <tr> <td>- Closed VA</td> <td>4.2/3.3</td> <td>5.7/4.4</td> </tr> <tr> <td>- P.f.</td> <td>0.25/0.25</td> <td></td> </tr> </table> </li> <li>AC operation, 50 Hz, for USA/Canada           <table border="0"> <tr> <td>- Closing VA</td> <td>26.4</td> <td>36</td> </tr> <tr> <td>- P.f. for closing</td> <td>0.81</td> <td>0.8</td> </tr> <tr> <td>- Closed VA</td> <td>4.4</td> <td>5.9</td> </tr> <tr> <td>- P.f. for closed</td> <td>0.24</td> <td></td> </tr> </table> </li> <li>AC operation, 60 Hz, for USA/Canada           <table border="0"> <tr> <td>- Closing VA</td> <td>31.7</td> <td>43</td> </tr> <tr> <td>- P.f. for closing</td> <td>0.81</td> <td>0.8</td> </tr> <tr> <td>- Closed VA</td> <td>4.8</td> <td>6.5</td> </tr> <tr> <td>- P.f. for closed</td> <td>0.25</td> <td></td> </tr> </table> </li> <li>DC operation (closing = closed) W 4</li> </ul>				- Closing VA	27/24.3	37/33	- P.f.	0.8/0.75		- Closed VA	4.2/3.3	5.7/4.4	- P.f.	0.25/0.25		- Closing VA	26.4	36	- P.f. for closing	0.81	0.8	- Closed VA	4.4	5.9	- P.f. for closed	0.24		- Closing VA	31.7	43	- P.f. for closing	0.81	0.8	- Closed VA	4.8	6.5	- P.f. for closed	0.25	
- Closing VA	27/24.3	37/33																																					
- P.f.	0.8/0.75																																						
- Closed VA	4.2/3.3	5.7/4.4																																					
- P.f.	0.25/0.25																																						
- Closing VA	26.4	36																																					
- P.f. for closing	0.81	0.8																																					
- Closed VA	4.4	5.9																																					
- P.f. for closed	0.24																																						
- Closing VA	31.7	43																																					
- P.f. for closing	0.81	0.8																																					
- Closed VA	4.8	6.5																																					
- P.f. for closed	0.25																																						
<b>Permissible residual current of the electronics</b> (with 0 signal)																																							
<ul style="list-style-type: none"> <li>AC operation &lt; 3 mA x (230 V/<math>U_s</math>)<sup>1)</sup> &lt; 4 mA x (230 V/<math>U_s</math>)<sup>1)</sup></li> <li>DC operation &lt; 10 mA x (24 V/<math>U_s</math>)<sup>1)</sup></li> </ul>																																							

<sup>1)</sup> The 3RT2916-1GA00 additional load module is recommended for higher residual currents, see page 3/114.

		Coupling contactors					
		3RT201.-.HB4.	3RT201.-.JB4.	3RT201.-.KB4.	3RT201.-.MB4.-0KT0	3RT201.-.VB4.	3RT201.-.SB4.
Type	Size	S00					
<b>Control</b>							
<b>Solenoid coil operating range</b>		0.7 ... 1.25 x $U_s$			0.85 ... 1.85 x $U_s$		
<b>Power consumption of the solenoid coils</b> (for cold coil) Closing = Closed		at $U_s$ 24 V DC W 2.8			1.6		
<b>Permissible residual current of the electronics</b> (with 0 signal)		< 6 mA x (24 V/ $U_s$ )			On request		
<b>Upright mounting position</b>		On request					
<b>Overvoltage configuration of the solenoid coil</b>		No overvoltage damping 	Integrated diode 	Integrated suppressor diode 	No overvoltage damping 	Integrated diode 	Integrated suppressor diode 

# Switching devices – Contactors and contactor assemblies – for switching motors

## Power contactors for switching motors

### SIRIUS 3RT contactors, 3-pole up to 250 kW

Type	Contactors				
Size	3RT2015	3RT2016	3RT2017	3RT2018	
<b>Rated data of the main contacts</b>					
<b>Load rating with AC</b>					
<b>Utilization category AC-3 and AC-3e</b>					
• Rated operational currents $I_e$	Up to 400 V A	7	9	12	16
	440 V A	7	9	11	14
	500 V A	6	7.7	9.2	12.4
	690 V A	4.9	6.7		8.9
• Rated power for slip-ring or squirrel-cage motors at 50 and 60 Hz	at 230 V kW	1.5	2.2	3	4
	400 V kW	3	4	5.5	7.5
	690 V kW	4	5.5		7.5
<b>Thermal load capacity</b>	10 s current A	56	72	96	128
<b>Power loss per main conducting path</b>	at $I_e$ /AC-3/ AC-3e/400 V W	0.2	0.3	0.5	1
<b>Utilization category AC-4 (at <math>I_a = 6 \times I_e</math>)<sup>1)</sup></b>					
• Maximum values					
- Rated operational current $I_e$	Up to 400 V A	6.5	8.5		11.5
- Rated power for squirrel-cage motors at 50 Hz and 60 Hz	Up to 400 V kW	3	4		5.5
• The following applies to a contact endurance of about 200 000 operating cycles:					
- Rated operational currents $I_e$	Up to 400 V A	2.6	4.1		5.5
	690 V A	1.8	3.3		4.4
- Rated power for squirrel-cage motors at 50 Hz and 60 Hz	at 230 V kW	0.67	1.1		1.5
	400 V kW	1.15	2		2.5
	690 V kW	1.15	2.5		3.5

<sup>1)</sup> The data only apply to 3RT2516 and 3RT2517 contactors (2 NO + 2 NC) up to a rated operational voltage of 400 V.

Type	Contactors	
Size	3RT2015 to 3RT2018	
<b>Conductor cross-sections</b>		
<b>Main conductors, auxiliary conductors and coil terminals</b> (1 or 2 conductors can be connected)		
• Solid or stranded	mm <sup>2</sup>	2 x (0.5 ... 1.5) <sup>1)</sup> ; 2 x (0.75 ... 2.5) <sup>1)</sup> ; max. 2 x 4
• Finely stranded with end sleeve (DIN 46228)	mm <sup>2</sup>	2 x (0.5 ... 1.5) <sup>1)</sup> ; 2 x (0.75 ... 2.5) <sup>1)</sup>
• AWG cables, solid or stranded	AWG	2 x (20 ... 16) <sup>1)</sup> ; 2 x (18 ... 14) <sup>1)</sup> ; 2 x 12
• Terminal screw		M3 (for Pozidriv size 2; Ø 5 ... 6 mm)
• Tightening torque	Nm	0.8 ... 1.2 (7 ... 10.3 lb.in)
<b>Main conductors, auxiliary conductors and coil terminals<sup>2)</sup></b> (1 or 2 conductors can be connected)		
• Operating devices	mm	3.0 x 0.5
• Solid or stranded	mm <sup>2</sup>	2 x (0.5 ... 4)
• Finely stranded with end sleeve (DIN 46228)	mm <sup>2</sup>	2 x (0.5 ... 2.5)
• Finely stranded without end sleeve	mm <sup>2</sup>	2 x (0.5 ... 2.5)
• AWG cables, solid or stranded	AWG	2 x (20 ... 12)
<b>Auxiliary conductors for front and laterally mounted auxiliary switches<sup>2)</sup></b> (1 or 2 conductors can be connected)		
• Operating devices	mm	3.0 x 0.5
• Solid or stranded	mm <sup>2</sup>	2 x (0.5 ... 2.5)
• Finely stranded with end sleeve (DIN 46228)	mm <sup>2</sup>	2 x (0.5 ... 1.5)
• Finely stranded without end sleeve	mm <sup>2</sup>	2 x (0.5 ... 2.5)
• AWG cables, solid or stranded	AWG	2 x (20 ... 14)



<sup>1)</sup> If two different conductor cross-sections are connected to one clamping point, both cross-sections must lie in one of the ranges specified.

<sup>2)</sup> Max. outer diameter of the conductor insulation: 3.6 mm. On spring-loaded terminals with conductor cross-sections  $\leq 1 \text{ mm}^2$ , an insulation stop is recommended, see page 3/115.

# Switching devices – Contactors and contactor assemblies – for switching motors

## Power contactors for switching motors

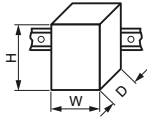
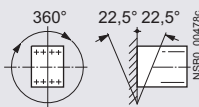
### SIRIUS 3RT contactors, 3-pole up to 250 kW

Type Size		Contactors	
		3RT2023 to 3RT2025 S0	3RT2026 to 3RT2028
<b>General data</b>			
<b>Dimensions (W x H x D)</b>			
<u>AC operation</u>			
<ul style="list-style-type: none"> <li>Basic unit           <ul style="list-style-type: none"> <li>Screw terminals</li> <li>Spring-loaded terminals</li> </ul> </li> <li>Basic unit with mounted auxiliary switch           <ul style="list-style-type: none"> <li>Screw terminals</li> <li>Spring-loaded terminals</li> </ul> </li> <li>Basic unit with mounted function module or solid-state time-delayed auxiliary switch           <ul style="list-style-type: none"> <li>Screw terminals</li> <li>Spring-loaded terminals</li> </ul> </li> </ul>		mm 45 x 85 x 97 mm 45 x 102 x 97	
<ul style="list-style-type: none"> <li>Basic unit with mounted auxiliary switch           <ul style="list-style-type: none"> <li>Screw terminals</li> <li>Spring-loaded terminals</li> </ul> </li> <li>Basic unit with mounted function module or solid-state time-delayed auxiliary switch           <ul style="list-style-type: none"> <li>Screw terminals</li> <li>Spring-loaded terminals</li> </ul> </li> </ul>	mm 45 x 85 x 141 mm 45 x 102 x 145		
<ul style="list-style-type: none"> <li>Basic unit with mounted function module or solid-state time-delayed auxiliary switch           <ul style="list-style-type: none"> <li>Screw terminals</li> <li>Spring-loaded terminals</li> </ul> </li> </ul>	mm 45 x 85 x 171 mm 45 x 102 x 171		
<u>DC operation</u>			
<ul style="list-style-type: none"> <li>Basic unit           <ul style="list-style-type: none"> <li>Screw terminals</li> <li>Spring-loaded terminals</li> </ul> </li> <li>Basic unit with mounted auxiliary switch           <ul style="list-style-type: none"> <li>Screw terminals</li> <li>Spring-loaded terminals</li> </ul> </li> <li>Basic unit with mounted function module or solid-state time-delayed auxiliary switch           <ul style="list-style-type: none"> <li>Screw terminals</li> <li>Spring-loaded terminals</li> </ul> </li> </ul>	mm 45 x 85 x 107 mm 45 x 102 x 107		
<ul style="list-style-type: none"> <li>Basic unit with mounted auxiliary switch           <ul style="list-style-type: none"> <li>Screw terminals</li> <li>Spring-loaded terminals</li> </ul> </li> <li>Basic unit with mounted function module or solid-state time-delayed auxiliary switch           <ul style="list-style-type: none"> <li>Screw terminals</li> <li>Spring-loaded terminals</li> </ul> </li> </ul>	mm 45 x 85 x 151 mm 45 x 102 x 155		
<ul style="list-style-type: none"> <li>Basic unit with mounted function module or solid-state time-delayed auxiliary switch           <ul style="list-style-type: none"> <li>Screw terminals</li> <li>Spring-loaded terminals</li> </ul> </li> </ul>	mm 45 x 85 x 181 mm 45 x 102 x 181		
<b>Permissible mounting position</b>			
The contactors are designed for operation on a vertical mounting surface.			
Upright mounting position		 <p>Special version required, also applies for 3RT202.-.K.40 coupling contactors</p>	
<b>Mechanical endurance</b>			
<ul style="list-style-type: none"> <li>Basic unit and basic unit with mounted auxiliary switch</li> </ul>	Operating cycles	10 million	
<ul style="list-style-type: none"> <li>Basic unit with solid-state compatible auxiliary switch</li> </ul>	Operating cycles	5 million	
<b>Electrical endurance</b>			
For contact endurance of the main contacts, <a href="#">see page 3/27</a> .			
<b>Rated insulation voltage <math>U_i</math></b> (pollution degree 3)		V	690
<b>Rated impulse withstand voltage <math>U_{imp}</math></b>			
<ul style="list-style-type: none"> <li>Auxiliary circuit</li> </ul>	kV	6	
<ul style="list-style-type: none"> <li>Main circuit</li> </ul>	kV	6	
<b>Protective separation</b> between the coil and the main contacts (according to IEC 60947-1, Annex N)		V	400
<b>Mirror contacts</b>			
A mirror contact is an auxiliary NC contact that cannot be closed simultaneously with an NO main contact.			
<ul style="list-style-type: none"> <li>Integrated auxiliary switches</li> </ul>		Yes, according to IEC 60947-4-1, Annex F	
<ul style="list-style-type: none"> <li>3RT2.2. (removable auxiliary switch)</li> </ul>		Yes, according to IEC 60947-4-1, Annex F	
<b>Permissible ambient temperature</b>			
<ul style="list-style-type: none"> <li>During operation</li> </ul>	°C	-25 ... +60	
<ul style="list-style-type: none"> <li>During storage</li> </ul>	°C	-55 ... +80	

# Switching devices – Contactors and contactor assemblies – for switching motors

## Power contactors for switching motors

### SIRIUS 3RT contactors, 3-pole up to 250 kW

Type Size	Contactors			
	3RT2023 to 3RT2025	3RT2026	3RT2027, 3RT2028	
<b>Short-circuit protection</b>				
<b>Main circuit</b>				
<ul style="list-style-type: none"> <li>Fuse links, operational class gG: LV HRC, type 3NA; DIAZED, type 5SB; NEOZED, type 5SE according to IEC 60947-4-1</li> <li>- Type of coordination "1"</li> <li>- Type of coordination "2"</li> <li>- Weld-free (test conditions according to IEC 60947-4-1)</li> </ul>	A	63	100	125
	A	25	35	50
	A	10	16	
<ul style="list-style-type: none"> <li>Miniature circuit breaker with C characteristic (short-circuit current 3 kA, type of coordination "1")</li> </ul>	A	25	32	40
<b>Auxiliary circuit</b>				
<ul style="list-style-type: none"> <li>Fuse links, operational class gG: DIAZED, type 5SB; NEOZED, type 5SE (weld-free protection at <math>I_k \leq 1</math> kA)</li> </ul>	A	10		
<ul style="list-style-type: none"> <li>230 V miniature circuit breaker, C characteristic (short-circuit current <math>I_k &lt; 400</math> A)</li> </ul>	A	10		
Short-circuit protection for contactors with overload relays	See Configuration Manual for load feeders			
Short-circuit protection for fuseless load feeders	See 3RA2 load feeders, page 8/5 onwards			

Type Size	Contactors					
	3RT2023 to 3RT2025	3RT2026 to 3RT2028	3RT202.-.NB3	3RT202.-.NF3.	3RT202.-.NP3	
<b>Control</b>						
<b>Type of operating mechanism</b>		AC or DC		AC/DC		
<b>Solenoid coil operating range</b>		AC/DC		0.8 ... 1.1 x $U_s$ <sup>1)</sup>		
<b>Power consumption of the solenoid coils</b> (for cold coil and 1.0 x $U_s$ )						
<ul style="list-style-type: none"> <li>AC operation, 50 Hz, standard version</li> <li>- Closing</li> <li>- P.f.</li> <li>- Closed</li> <li>- P.f.</li> </ul>	VA	65	77	6.6	11.9	12.7
		0.82		0.98		
	VA	7.6	9.8	1.9	1.6	3.9
		0.25		0.86	0.79	0.51
<ul style="list-style-type: none"> <li>AC operation, 50/60 Hz, standard version</li> <li>- Closing</li> <li>- P.f.</li> <li>- Closed</li> <li>- P.f.</li> </ul>	VA	68/67	81/79	6.6/6.7	11.9/12.0	12.7/14.7
		0.72/0.74		0.98/0.98		
	VA	7.9/6.5	10.5/8.5	1.9/2.0	1.6/1.8	3.9/4.3
		0.25/0.28		0.86/0.82	0.79/0.74	0.51/0.56
<ul style="list-style-type: none"> <li>AC operation, 50 Hz, for USA/Canada</li> <li>- Closing</li> <li>- P.f.</li> <li>- Closed</li> <li>- P.f.</li> </ul>	VA	65	77	--		
		0.82	0.82	--		
	VA	7 <sup>3)</sup> /7.6	9.8	--		
		0.25	0.28	--		
<ul style="list-style-type: none"> <li>AC operation, 60 Hz, for USA/Canada</li> <li>- Closing</li> <li>- P.f.</li> <li>- Closed</li> <li>- P.f.</li> </ul>	VA	73	87	--		
		0.76		--		
	VA	7.2	9.4	--		
		0.28		--		
<ul style="list-style-type: none"> <li>DC operation (closing = closed)</li> </ul>	W	5.9/5.9		5.9/1.4	10.2/1.3	14.3/1.9
<b>Permissible residual current of the electronics</b> (with 0 signal)						
<ul style="list-style-type: none"> <li>AC operation</li> <li>DC operation</li> </ul>	mA	< 6 mA x (230 V/ $U_s$ )		< 7 mA x (230 V/ $U_s$ )		
	mA	< 16 mA x (24 V/ $U_s$ )				
1) Coil operating range		2) The following applies to $U_{s \max} = 280$ V: Upper limit = 1.1 x $U_{s \max}$				
- At 50 Hz: 0.8 to 1.1 x $U_s$		3) Value applies to 3RT2023 contactor at 50 Hz AC.				
- At 60 Hz: 0.85 to 1.1 x $U_s$						

Type Size	Coupling contactors	
	3RT202.-.KB4.	S0
<b>Control</b>		
<b>Solenoid coil operating range</b>		0.7 ... 1.25 x $U_s$
<b>Power consumption of the solenoid coils</b> (for cold coil) Closing = Closed		at $U_s$ 24 V DC W 4.5
<b>Permissible residual current</b> of the electronics (with 0 signal)		< 10 mA x (24 V/ $U_s$ )
<b>Overvoltage configuration of the solenoid coil</b>		Integrated varistor 

# Switching devices – Contactors and contactor assemblies – for switching motors

## Power contactors for switching motors

### SIRIUS 3RT contactors, 3-pole up to 250 kW

Type Size	Contactors						
	3RT2023	3RT2024	3RT2025	3RT2026	3RT2027	3RT2028	
<b>Rated data of the main contacts</b>							
<b>Load rating with AC</b>							
<b>Utilization category AC-3 and AC-3e</b>							
• Rated operational currents $I_e$	Up to 400 V A	9	12	17	25	32	38
	440 V A	9	12	17	22	32	35
	500 V A	9	12	17	18	32	
	690 V A	9		13		21	
• Rated power for slip-ring or squirrel-cage motors at 50 and 60 Hz	at 230 V kW	2.2	3	4	5.5	7.5	11
	400 V kW	4	5.5	7.5	11	15	18.5
	690 V kW	7.5		11		18.5	
<b>Thermal load capacity</b>	10 s current A	80	110	150	200	260	304
<b>Power loss per main conducting path</b>	at $I_e/AC-3/AC-3e/400 V$ W	0.2	0.3	0.6	1.9	2.3	3.2
<b>Utilization category AC-4 (at <math>I_a = 6 \times I_e</math>)</b>							
• Maximum values:							
- Rated operational current $I_e$	Up to 400 V A	8.5	12.5	15.5		22	
- Rated power for squirrel-cage motors at 50 Hz and 60 Hz	at 400 V kW	4	5.5	7.5		11	
• The following applies to a contact endurance of about 200 000 operating cycles:							
- Rated operational currents $I_e$	Up to 400 V A	4.1	5.5	7.7	9	12	
	690 V A	3.3	5.5	7.7	9	12	
- Rated power for squirrel-cage motors at 50 Hz and 60 Hz	at 110 V kW	0.5	0.73	1	1.2	1.6	
	230 V kW	1.1	1.5	2	2.5	3.4	
	400 V kW	2	2.6	3.5	4.4	6	
	690 V kW	2.5	4.6	6	7.7	10.3	

Type Size	Contactors	
	3RT2023 to 3RT2028	S0
<b>Conductor cross-sections</b>		
<b>Main conductors</b> (1 or 2 conductors can be connected)		
• Solid or stranded	mm <sup>2</sup>	2 x (1 ... 2.5) <sup>1)</sup> ; 2 x (2.5 ... 10) <sup>1)</sup>
• Finely stranded with end sleeve (DIN 46228)	mm <sup>2</sup>	2 x (1 ... 2.5) <sup>1)</sup> ; 2 x (2.5 ... 6) <sup>1)</sup> ; 1 x 10
• AWG cables, solid or stranded	AWG	2 x (16 ... 12) <sup>1)</sup> ; 2 x (14 ... 8) <sup>1)</sup>
• Terminal screws - Tightening torque	Nm	M4 (for Pozidriv size 2; Ø 5 ... 6 mm) 2 ... 2.5 (18 ... 22 lb.in)
<b>Auxiliary conductors</b> (1 or 2 conductors can be connected)		
• Solid or stranded	mm <sup>2</sup>	2 x (0.5 ... 1.5) <sup>1)</sup> ; 2 x (0.75 ... 2.5) <sup>1)</sup>
• Finely stranded with end sleeve (DIN 46228)	mm <sup>2</sup>	2 x (0.5 ... 1.5) <sup>1)</sup> ; 2 x (0.75 ... 2.5) <sup>1)</sup>
• AWG cables, solid or stranded	AWG	2 x (20 ... 16) <sup>1)</sup> ; 2 x (18 ... 14) <sup>1)</sup>
• Terminal screws - Tightening torque	Nm	M3 (for Pozidriv size 2; Ø 5 ... 6 mm) 0.8 ... 1.2 (7 ... 10.3 lb.in)
<b>Main conductors<sup>2)</sup></b> (1 or 2 conductors can be connected)		
• Operating devices	mm	3.0 x 0.5
• Solid or stranded	mm <sup>2</sup>	2 x (1 ... 10)
• Finely stranded with end sleeve (DIN 46228)	mm <sup>2</sup>	2 x (1 ... 6)
• Finely stranded without end sleeve	mm <sup>2</sup>	2 x (1 ... 6)
• AWG cables, solid or stranded	AWG	2 x (18 ... 8)
<b>Auxiliary conductors<sup>2)</sup></b> (1 or 2 conductors can be connected)		
• Operating devices		3.0 x 0.5
• Solid or stranded	mm <sup>2</sup>	2 x (0.5 ... 2.5)
• Finely stranded with end sleeve (DIN 46228)	mm <sup>2</sup>	2 x (0.5 ... 1.5)
• Finely stranded without end sleeve	mm <sup>2</sup>	2 x (0.5 ... 2.5)
• AWG cables, solid or stranded	AWG	2 x (20 ... 14)

<sup>1)</sup> If two different conductor cross-sections are connected to one clamping point, both cross-sections must lie in one of the ranges specified.

<sup>2)</sup> Max. outer diameter of the conductor insulation: 6.4 mm. On spring-loaded terminals with conductor cross-sections ≤ 1 mm<sup>2</sup>, an insulation stop is recommended, see page 3/115.



# Switching devices – Contactors and contactor assemblies – for switching motors

## Power contactors for switching motors

### SIRIUS 3RT contactors, 3-pole up to 250 kW

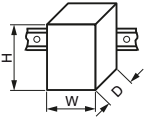
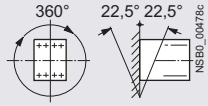
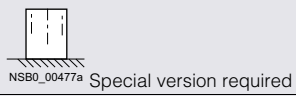
Type Size	Contactors				
	3RT2035 S2	3RT2036	3RT2037	3RT2038	
<b>General data</b>					
<b>Dimensions (W x H x D)</b>					
<ul style="list-style-type: none"> <li>Basic unit               <ul style="list-style-type: none"> <li>Screw/spring-loaded terminals</li> </ul> </li> <li>Basic unit with mounted auxiliary switch               <ul style="list-style-type: none"> <li>Screw terminals</li> <li>Spring-loaded terminals</li> </ul> </li> <li>Basic unit with mounted function module or solid-state time-delayed auxiliary switch               <ul style="list-style-type: none"> <li>Screw/spring-loaded terminals</li> </ul> </li> </ul>		mm	55 x 114 x 130		
		mm	55 x 114 x 174		
		mm	55 x 114 x 178		
		mm	55 x 114 x 204		
<b>Permissible mounting position</b>					
The contactors are designed for operation on a vertical mounting surface.					
Upright mounting position					
<b>Mechanical endurance</b>					
<ul style="list-style-type: none"> <li>Basic units and basic units with mounted auxiliary switch</li> </ul>	Operating cycles	10 million (3RT203.-S.30: 5 million)			
<ul style="list-style-type: none"> <li>Basic units with solid-state compatible auxiliary switch</li> </ul>	Operating cycles	5 million			
<b>Electrical endurance</b>					
For contact endurance of the main contacts, see page 3/28.					
<b>Rated insulation voltage <math>U_i</math></b> (pollution degree 3)		V	690		
<b>Rated impulse withstand voltage <math>U_{imp}</math></b>					
<ul style="list-style-type: none"> <li>Auxiliary circuit</li> </ul>	kV	6			
<ul style="list-style-type: none"> <li>Main circuit</li> </ul>	kV	6			
<b>Protective separation</b> between the coil and the main contacts (according to IEC 60947-1, Annex N)		V	400		
<b>Mirror contacts</b>					
A mirror contact is an auxiliary NC contact that cannot be closed simultaneously with an NO main contact.					
<ul style="list-style-type: none"> <li>Integrated auxiliary switches</li> <li>3RT2.3. (removable auxiliary switch)</li> </ul>	Yes, according to IEC 60947-4-1, Annex F Yes, according to IEC 60947-4-1, Annex F				
<b>Permissible ambient temperature</b>					
<ul style="list-style-type: none"> <li>During operation</li> </ul>	°C	-25 ... +60			
<ul style="list-style-type: none"> <li>During storage</li> </ul>	°C	-55 ... +80			
<b>Short-circuit protection</b>					
<b>Main circuit</b>					
<ul style="list-style-type: none"> <li>Fuse links, operational class gG: LV HRC, type 3NA; DIAZED, type 5SB; NEOZED, type 5SE according to IEC 60947-4-1               <ul style="list-style-type: none"> <li>Type of coordination "1"</li> <li>Type of coordination "2"</li> <li>Weld-free (test conditions according to IEC 60947-4-1)</li> </ul> </li> </ul>					
	A	160	250	160	
	A	80	125		
	A	16	25	50	
<b>Auxiliary circuit</b>					
<ul style="list-style-type: none"> <li>Fuse links, operational class gG: DIAZED, type 5SB; NEOZED, type 5SE (weld-free protection at <math>I_k \leq 1</math> kA)</li> </ul>	A	10			
<ul style="list-style-type: none"> <li>230 V miniature circuit breaker, C characteristic (short-circuit current <math>I_k &lt; 400</math> A)</li> </ul>	A	10			
Short-circuit protection for contactors with overload relays		See Configuration Manual for load feeders			
Short-circuit protection for fuseless load feeders		See 3RA2 load feeders, page 8/5 onwards			

# Switching devices – Contactors and contactor assemblies – for switching motors

## Power contactors for switching motors

### SIRIUS 3RT contactors, 3-pole up to 250 kW

Type	Contactors			Coupling contactors
	3RT203.-A..., 3RT203.-C...	3RT203.-N.3.	3RT203.-S.3.	3RT203.-KB4.
Size	S2			
<b>Control</b>				
<b>Type of operating mechanism</b>	AC	AC/DC	DC	
<b>Solenoid coil operating range</b>				
• AC operation <sup>1)</sup>	0.8 ... 1.1 x U <sub>s</sub>	--		
• AC/DC operation <sup>1)</sup>	--	0.8 ... 1.1 x U <sub>s</sub>		
• DC operation	--	--	0.8 ... 1.2 x U <sub>s</sub>	
<b>Power consumption of the solenoid coils</b> (for cold coil and 1.0 x U <sub>s</sub> )				
• AC operation, 50 Hz, standard version				
- Closing	VA	190	--	--
- P.f.		0.72	--	--
- Closed	VA	16	--	--
- P.f.		0.37	--	--
• AC operation, 50/60 Hz, standard version				
- Closing	VA	210/188	--	--
- P.f.		0.69/0.65	--	--
- Closed	VA	17.2/16.5	--	--
- P.f.		0.36/0.39	--	--
• AC operation, 60 Hz, for USA/Canada				
- Closing	VA	212	--	--
- P.f.		0.67	--	--
- Closed	VA	18.5	--	--
- P.f.		0.37	--	--
• AC/DC operation				
- Closing for AC operation	VA	--	40	--
- P.f.		--	0.95	--
- Closed for AC operation	VA	--	2	--
- P.f.		--	0.95	--
- Closing for DC operation	VA	--	23 <sup>2)</sup>	0.7
- Closed for DC operation	VA	--	1	1.6
• DC operation				
- Closing for DC operation	W	--	--	21.5 <sup>3)</sup>
- Closed for DC operation	W	--	--	1
<b>Permissible residual current of the electronics</b> (with 0 signal)				
• AC/DC operation	mA	--	< 20	--
• DC operation	mA	--	--	< 20
<b>Overvoltage configuration of the solenoid coil</b>	--	Integrated varistor 		
<b>PLC control input</b> according to IEC 60947-1				
• Solid-state operating mechanism		--	Type 1	--
• Rated voltage	V DC	--	24	--
• Operating range	V DC	--	17 ... 30	--
• Power consumption	mA	--	≤ 30	--
• Recovery time after mains failure, typical	s	--	2	--

<sup>1)</sup> Coil operating range  
 - At 50 Hz: 0.8 to 1.1 x U<sub>s</sub>,  
 - At 60 Hz: 0.85 to 1.1 x U<sub>s</sub>.

<sup>2)</sup> In the case of AC/DC coils, increased pickup currents (2.6 A on average) arise during the first 230 ms. For direct control by PLC, we therefore recommend special coupling contactors with reduced power consumption. The connection of one 3RT203.-KB4. coupling contactor is possible per PLC output port with an output current of 2 A, see page 3/59.



<sup>3)</sup> In the case of DC coils, increased pickup currents (2.1 A on average) arise during the first 230 ms.

# Switching devices – Contactors and contactor assemblies – for switching motors

## Power contactors for switching motors

### SIRIUS 3RT contactors, 3-pole up to 250 kW

		Contactors				
Type		3RT2035	3RT2036	3RT2037	3RT2038	
Size		S2				
<b>Rated data of the main contacts</b>						
<b>Load rating with AC</b>						
<b>Utilization category AC-3 and AC-3e</b>						
• Rated operational currents $I_e$	Up to 400 V	A	41	51	65	80
	440 V	A	41	51	65	80
	500 V	A	41	51	65	80
	690 V	A	24		47	58
• Rated power for slip-ring or squirrel-cage motors at 50 and 60 Hz	at 230 V	kW	11	15	18.5	22
	400 V	kW	18.5	22	30	37
	690 V	kW	22		37	45
<b>Thermal load capacity</b>	10 s current	A	400	420	520	640
<b>Power loss per main conducting path</b>	at $I_e/AC-3/AC-3e/400 V$	W	2.2	4	3.8	5.7
<b>Utilization category AC-4 (at <math>I_a = 6 \times I_e</math>)</b>						
• Maximum values						
- Rated operational current $I_e$	Up to 400 V	A	35	41	55	
- Rated power for squirrel-cage motors at 50 Hz and 60 Hz	at 400 V	kW	18.5	22	30	
• The following applies to a contact endurance of about 200 000 operating cycles:						
- Rated operational currents $I_e$	Up to 400 V	A	22	24	28	30
	690 V	A	18.5	20	22	24
- Rated power for squirrel-cage motors at 50 Hz and 60 Hz	at 110 V	kW	3.2	3.5	4.1	4.3
	230 V	kW	6.7	7.3	8.5	9.1
	400 V	kW	11.6	12.6	14.7	15.8
	690 V	kW	16.8	18.2	20	21.8

		Contactors	
Type		3RT2035 to 3RT2038	
Size		S2	
<b>Conductor cross-sections</b>			
<b>Main conductors</b> (1 or 2 conductors can be connected)		 <b>Screw terminals</b>	
• Solid or stranded	mm <sup>2</sup>	2 x (1 ... 35) <sup>1)</sup> ; 1 x (1 ... 50) <sup>1)</sup>	
• Finely stranded with end sleeve (DIN 46228)	mm <sup>2</sup>	2 x (1 ... 25) <sup>1)</sup> ; 1 x (1 ... 35) <sup>1)</sup>	
• AWG cables, solid or stranded	AWG	2 x (18 ... 2) <sup>1)</sup> ; 1 x (18 ... 1) <sup>1)</sup>	
• Terminal screws - Tightening torque	Nm	Pozidriv size 2; Ø 5 ... 6 mm 3 ... 4.5 (27 ... 40 lb.in)	
<b>Auxiliary conductors and control conductors</b> (1 or 2 conductors can be connected)		 <b>Spring-loaded terminals</b>	
• Solid or stranded	mm <sup>2</sup>	2 x (0.5 ... 1.5) <sup>1)</sup> ; 2 x (0.75 ... 2.5) <sup>1)</sup>	
• Finely stranded with end sleeve (DIN 46228)	mm <sup>2</sup>	2 x (0.5 ... 1.5) <sup>1)</sup> ; 2 x (0.75 ... 2.5) <sup>1)</sup>	
• AWG cables, solid or stranded	AWG	2 x (20 ... 16) <sup>1)</sup> ; 2 x (18 ... 14) <sup>1)</sup>	
• Terminal screws - Tightening torque	Nm	M3 (for Pozidriv size 2; Ø 5 ... 6 mm) 0.8 ... 1.2 (7 ... 10.3 lb.in)	
<b>Auxiliary and control conductors<sup>2)</sup></b> (1 or 2 conductors can be connected)			
• Operating devices	mm	3.0 x 0.5	
• Solid or stranded	mm <sup>2</sup>	2 x (0.5 ... 2.5)	
• Finely stranded with end sleeve (DIN 46228)	mm <sup>2</sup>	2 x (0.5 ... 1.5)	
• Finely stranded without end sleeve	mm <sup>2</sup>	2 x (0.5 ... 2.5)	
• AWG cables, solid or stranded	AWG	2 x (20 ... 14)	

<sup>1)</sup> If two different conductor cross-sections are connected to one clamping point, both cross-sections must lie in one of the ranges specified.

<sup>2)</sup> Max. outer diameter of the conductor insulation: 3.6 mm.  
On spring-loaded terminals with conductor cross-sections  $\leq 1 \text{ mm}^2$ , an insulation stop is recommended, see page 3/115.

# Switching devices – Contactors and contactor assemblies – for switching motors

## Power contactors for switching motors

### SIRIUS 3RT contactors, 3-pole up to 250 kW

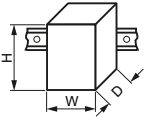
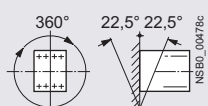
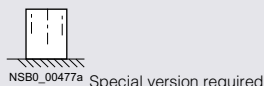
Type Size	Contactors		
	3RT2045 S3	3RT2046	3RT2047
<b>General data</b>			
<b>Dimensions (W x H x D)</b>			
<ul style="list-style-type: none"> <li>Basic unit - Screw/spring-loaded terminals</li> </ul>		mm	70 x 140 x 152
<ul style="list-style-type: none"> <li>Basic unit with mounted auxiliary switch - Screw terminals - Spring-loaded terminals</li> </ul>		mm mm	70 x 140 x 196 70 x 140 x 200
<ul style="list-style-type: none"> <li>Basic unit with mounted function module or solid-state time-delayed auxiliary switch - Screw/spring-loaded terminals</li> </ul>		mm	70 x 140 x 226
<b>Permissible mounting position</b>			
The contactors are designed for operation on a vertical mounting surface.			
Upright mounting position			
<b>Mechanical endurance</b>			
<ul style="list-style-type: none"> <li>Basic units and basic units with mounted auxiliary switch</li> </ul>	Operating cycles	10 million	
<ul style="list-style-type: none"> <li>Basic units with solid-state compatible auxiliary switch</li> </ul>	Operating cycles	5 million	
<b>Electrical endurance</b>			
For contact endurance of the main contacts, see page 3/28.			
<b>Rated insulation voltage <math>U_i</math></b> (pollution degree 3)	V	1 000 (3RT20...-.....-OCC0: 690)	
<b>Rated impulse withstand voltage <math>U_{imp}</math></b>			
<ul style="list-style-type: none"> <li>Auxiliary circuit</li> </ul>	kV	6	
<ul style="list-style-type: none"> <li>Main circuit</li> </ul>	kV	8	
<b>Protective separation</b> between the coil and the main contacts (according to IEC 60947-1, Annex N)	V	690	
<b>Mirror contacts</b>			
A mirror contact is an auxiliary NC contact that cannot be closed simultaneously with an NO main contact.			
<ul style="list-style-type: none"> <li>Integrated auxiliary switches</li> <li>3RT2.4. (removable auxiliary switch)</li> </ul>	Yes, according to IEC 60947-4-1, Annex F Yes, according to IEC 60947-4-1, Annex F		
<b>Permissible ambient temperature</b>			
<ul style="list-style-type: none"> <li>During operation</li> </ul>	°C	-25 ... +60	
<ul style="list-style-type: none"> <li>During storage</li> </ul>	°C	-55 ... +80	
<b>Short-circuit protection</b>			
<b>Main circuit</b>			
<ul style="list-style-type: none"> <li>Fuse links, operational class gG: LV HRC, type 3NA; DIAZED, type 5SB; NEOZED, type 5SE according to IEC 60947-4-1</li> </ul>			
<ul style="list-style-type: none"> <li>- Type of coordination "1"</li> </ul>	A	250	
<ul style="list-style-type: none"> <li>- Type of coordination "2"</li> </ul>	A	160	160
<ul style="list-style-type: none"> <li>- Weld-free (test conditions according to IEC 60947-4-1)</li> </ul>	A	On request	200
<b>Auxiliary circuit</b>			
<ul style="list-style-type: none"> <li>Fuse links, operational class gG: DIAZED, type 5SB; NEOZED, type 5SE (weld-free protection at <math>I_k \leq 1</math> kA)</li> </ul>	A	10	
<ul style="list-style-type: none"> <li>230 V miniature circuit breaker, C characteristic (short-circuit current <math>I_k &lt; 400</math> A)</li> </ul>	A	10	
Short-circuit protection for contactors with overload relays		See Configuration Manual for load feeders	
Short-circuit protection for fuseless load feeders		See 3RA2 load feeders, page 8/5 onwards	

# Switching devices – Contactors and contactor assemblies – for switching motors

## Power contactors for switching motors

### SIRIUS 3RT contactors, 3-pole up to 250 kW

Type	Contactors			Coupling contactors
	3RT204.-A..., 3RT204.-C...	3RT204.-N.3.	3RT204.-S.3.	3RT204.-KB4.
Size	S3			
<b>Control</b>				
<b>Type of operating mechanism</b>	AC	AC/DC	DC	
<b>Solenoid coil operating range</b>				
• AC operation <sup>1)</sup>	0.8 ... 1.1 x U <sub>s</sub>	--		
• AC/DC operation <sup>1)</sup>	--	0.8 ... 1.1 x U <sub>s</sub>		
• DC operation	--	--	0.8 ... 1.2 x U <sub>s</sub>	
<b>Power consumption of the solenoid coils</b> (for cold coil and 1.0 x U <sub>s</sub> )				
• AC operation, 50 Hz, standard version				
- Closing	VA	296	--	--
- P.f.		0.61	--	--
- Closed	VA	19	--	--
- P.f.		0.38	--	--
• AC operation, 50/60 Hz, standard version				
- Closing	VA	348/296	--	--
- P.f.		0.62/0.55	--	--
- Closed	VA	25/18	--	--
- P.f.		0.35/0.41	--	--
• AC operation, 60 Hz, for USA/Canada				
- Closing	VA	326	--	--
- P.f.		0.62	--	--
- Closed	VA	22	--	--
- P.f.		0.38	--	--
• AC/DC operation				
- Closing for AC operation	VA	--	163	130
- P.f.		--	0.95	--
- Closed for AC operation	VA	--	3.1	2.4
- P.f.		--	0.95	0.7
- Closing for DC operation	VA	--	76 <sup>2)</sup>	130
- Closed for DC operation	VA	--	1.8	--
• DC operation				
- Closing for DC operation	W	--	--	25 <sup>3)</sup>
- Closed for DC operation	W	--	--	0.9
<b>Permissible residual current of the electronics</b> (with 0 signal)				
• AC/DC operation	mA	--	< 20	--
• DC operation	mA	--	--	< 20
<b>Overvoltage configuration of the solenoid coil</b>	--	Integrated varistor 		
<b>PLC control input</b> according to IEC 60947-1				
• Solid-state operating mechanism	--	--	Type 1	--
• Rated voltage	V DC	--	24	--
• Operating range	V DC	--	17 ... 30	--
• Power consumption	mA	--	≤ 30	--
• Recovery time after mains failure, typical	s	--	2	--

<sup>1)</sup> Coil operating range  
 - at 50 Hz: 0.8 to 1.1 x U<sub>s</sub>  
 - at 60 Hz: 0.85 to 1.1 x U<sub>s</sub>.

<sup>2)</sup> In the case of AC/DC coils, increased pickup currents (6.5 A on average) arise during the first 150 ms. For direct control by PLC, we therefore recommend special coupling contactors with reduced power consumption. The connection of one 3RT204.-KB4. coupling contactor is possible per PLC output port with an output current of 2 A, see page 3/59.



<sup>3)</sup> In the case of DC coils, increased pickup currents (2.1 A on average) arise during the first 150 ms.

# Switching devices – Contactors and contactor assemblies – for switching motors

## Power contactors for switching motors

### SIRIUS 3RT contactors, 3-pole up to 250 kW

Type		Contactors		
Size		3RT2045	3RT2046	3RT2047
<b>Rated data of the main contacts</b>				
<b>Load rating with AC</b>				
<b>Utilization category AC-3 and AC-3e</b>				
• Rated operational currents $I_e$	Up to 400 V A	80	95	110
	500 V A	80	95	110
	690 V A	58	78	98
	1 000 V A	30		
• Rated power for slip-ring or squirrel-cage motors at 50 and 60 Hz	at 230 V kW	22	22	30
	400 V kW	37	45	55
	690 V kW	55	75	90
	1 000 V kW	37		
<b>Thermal load capacity</b>	10 s current A	760		880
<b>Power loss per main conducting path</b>	at $I_e/AC-3/AC-3e/400 V$ W	5.3	6.6	7.9
<b>Utilization category AC-4 (at <math>I_a = 6 \times I_e</math>)</b>				
• Maximum values				
- Rated operational current $I_e$	Up to 400 V A	66	80	97
- Rated power for squirrel-cage motors at 50 Hz and 60 Hz	at 400 V kW	37	45	55
• The following applies to a contact endurance of about 200 000 operating cycles:				
- Rated operational currents $I_e$	Up to 400 V A	34	42	46
	690 V A	24	30	36
- Rated power for squirrel-cage motors at 50 Hz and 60 Hz	at 110 V kW	4.9	6.1	6.7
	230 V kW	10.4	12	14
	400 V kW	17.9	22	24.3
	690 V kW	21.8	27.4	32.9

Type		Contactors	
Size		3RT2045 to 3RT2047	S3
<b>Conductor cross-sections</b>			
<b>Main conductors</b> (1 or 2 conductors can be connected)		 <b>Screw terminals</b>	
• Solid	mm <sup>2</sup>	2 x (2.5 ... 16) <sup>1)</sup>	
• Stranded	mm <sup>2</sup>	2 x (6 ... 16) <sup>1)</sup> ; 2 x (10 ... 50) <sup>1)</sup> ; 1 x (10 ... 70) <sup>1)</sup>	
• Finely stranded with end sleeve (DIN 46228)	mm <sup>2</sup>	2 x (2.5 ... 35) <sup>1)</sup> ; 1 x (2.5 ... 50) <sup>1)</sup>	
• AWG cables, solid or stranded	AWG	2 x (10 ... 1/0) <sup>1)</sup> ; 1 x (10 ... 2/0) <sup>1)</sup>	
• Terminal screws		Hexagon socket, size 4	
- Tightening torque	Nm	4.5 ... 6 (40 ... 53 lb.in)	
<b>Auxiliary conductors and control conductors</b> (1 or 2 conductors can be connected)			
• Solid or stranded	mm <sup>2</sup>	2 x (0.5 ... 1.5) <sup>1)</sup> ; 2 x (0.75 ... 2.5) <sup>1)</sup>	
• Finely stranded with end sleeve (DIN 46228)	mm <sup>2</sup>	2 x (0.5 ... 1.5) <sup>1)</sup> ; 2 x (0.75 ... 2.5) <sup>1)</sup>	
• AWG cables, solid or stranded	AWG	2 x (20 ... 16) <sup>1)</sup> ; 2 x (18 ... 14) <sup>1)</sup>	
• Terminal screws		M3 (for Pozidriv size 2; $\varnothing$ 5 ... 6 mm)	
- Tightening torque	Nm	0.8 ... 1.2 (7 ... 10.3 lb.in)	
<b>Auxiliary and control conductors<sup>2)</sup></b> (1 or 2 conductors can be connected)		 <b>Spring-loaded terminals</b>	
• Operating devices	mm	3.0 x 0.5	
• Solid or stranded	mm <sup>2</sup>	2 x (0.5 ... 2.5)	
• Finely stranded with end sleeve (DIN 46228)	mm <sup>2</sup>	2 x (0.5 ... 1.5)	
• Finely stranded without end sleeve	mm <sup>2</sup>	2 x (0.5 ... 2.5)	
• AWG cables, solid or stranded	AWG	2 x (20 ... 16)	

<sup>1)</sup> If two different conductor cross-sections are connected to one clamping point, both cross-sections must lie in one of the ranges specified.

<sup>2)</sup> Max. outer diameter of the conductor insulation: 3.6 mm. On spring-loaded terminals with conductor cross-sections  $\leq 1 \text{ mm}^2$ , an insulation stop is recommended, see page 3/115.

# Switching devices – Contactors and contactor assemblies – for switching motors

## Power contactors for switching motors

### SIRIUS 3RT contactors, 3-pole up to 250 kW

Type	Contactors					
	3RT1054	3RT1055, 3RT1056	3RT1064 to 3RT1066	3RT1075	3RT1076	
Size	S6		S10	S12		
<b>General data</b>						
<b>Dimensions (W x H x D)</b>						
<ul style="list-style-type: none"> <li>Basic unit</li> <li>Basic unit with mounted auxiliary switch</li> </ul>			mm	120 x 172 x 170	145 x 210 x 202	160 x 214 x 225
			mm	120 x 172 x 217	145 x 210 x 251	160 x 214 x 271
<b>Permissible mounting position</b>						
The contactors are designed for operation on a vertical mounting surface.						
<b>Mechanical endurance</b>						
	Operating cycles	10 million				
<b>Electrical endurance</b>						
For contact endurance of the main contacts, <a href="#">see page 3/28</a> .						
<b>Rated insulation voltage <math>U_i</math></b> (pollution degree 3)						
	V	1 000				
<b>Rated impulse withstand voltage <math>U_{imp}</math></b>						
<ul style="list-style-type: none"> <li>Auxiliary circuit</li> <li>Main circuit</li> </ul>	kV	6				
	kV	8				
<b>Protective separation</b> between the coil and the main contacts according to IEC 60947-1, Annex N						
	V	690				
<b>Mirror contacts</b>						
A mirror contact is an auxiliary NC contact that cannot be closed simultaneously with an NO main contact.			Yes, according to IEC 60947-4-1, Annex F			
<b>Permissible ambient temperature</b>						
<ul style="list-style-type: none"> <li>During operation</li> <li>During storage</li> </ul>	°C	-25 ... +60				
	°C	-55 ... +80				
<b>Electromagnetic compatibility (EMC)</b>						
<a href="#">See page 3/21</a>						
<b>Short-circuit protection</b>						
<b>Main circuit</b>						
Fuse links, operational class gG: LV HRC, type 3NA; DIAZED, type 5SB; NEOZED, type 5SE according to IEC 60947-4-1						
<ul style="list-style-type: none"> <li>Type of coordination "1"</li> <li>Type of coordination "2"</li> <li>Weld-free</li> </ul>	A	355		500	630	
	A	250	315	400	500	
	A	80	160	250		315
<b>Auxiliary circuit</b>						
Short-circuit test						
<ul style="list-style-type: none"> <li>With fuse links of operational class gG: DIAZED, type 5SB; NEOZED, type 5SE with short-circuit current <math>I_k = 1</math> kA according to IEC 60947-5-1</li> <li>With miniature circuit breakers with C characteristic with short-circuit current <math>I_k = 400</math> A</li> </ul>	A	10				
	A	10				
Short-circuit protection for contactors with overload relays						
<a href="#">See Configuration Manual for load feeders</a>						

# Switching devices – Contactors and contactor assemblies – for switching motors

## Power contactors for switching motors

### SIRIUS 3RT contactors, 3-pole up to 250 kW

Type Size	Contactors		
	3RT105. S6	3RT106. S10	3RT107. S12
<b>Control</b>			
<b>Operating range of the solenoid operating mechanism</b>	AC/DC	0.8 x $U_{s \text{ min}}$ ... 1.1 x $U_{s \text{ max}}$	
<b>Power consumption of the solenoid operating mechanism</b> (with cold coil and rated range $U_{s \text{ min}}$ ... $U_{s \text{ max}}$ )			
• Standard operating mechanism (3RT10...-A)			
- AC operation	Closing at $U_{s \text{ min}}$ Closing at $U_{s \text{ max}}$ Closed at $U_{s \text{ min}}$ Closed at $U_{s \text{ max}}$	VA/p.f. VA/p.f. VA/p.f. VA/p.f.	250/0.9 300/0.9 4.8/0.8 5.8/0.8
- DC operation	Closing at $U_{s \text{ min}}$ Closing at $U_{s \text{ max}}$ Closed at $U_{s \text{ min}}$ Closed at $U_{s \text{ max}}$	W W W W	300 360 4.3 5.2
• Solid-state operating mechanism (3RT10...-N/-P/-S)			
- AC operation	Closing at $U_{s \text{ min}}$ Closing at $U_{s \text{ max}}$ Closed at $U_{s \text{ min}}$ Closed at $U_{s \text{ max}}$	VA/p.f. VA/p.f. VA/p.f. VA/p.f.	190/0.8 280/0.8 3.5/0.6 4.8/0.6
- DC operation	Closing at $U_{s \text{ min}}$ Closing at $U_{s \text{ max}}$ Closed at $U_{s \text{ min}}$ Closed at $U_{s \text{ max}}$	W W W W	250 320 2.1 2.8
<b>PLC control input</b> according to IEC 60947-1			
• Solid-state operating mechanism	3RT10...-N/-P 3RT10...-S		Type 2 Type 1
• Rated voltage		V DC	24
• Operating range		V DC	17 ... 30
• Power consumption		mA	≤ 30
• Recovery time after mains failure, typical (applicable only for fail-safe version 3RT10...-S)		s	2



# Switching devices – Contactors and contactor assemblies – for switching motors

## Power contactors for switching motors





### SIRIUS 3RT contactors, 3-pole up to 250 kW

Type Size	Contactors								
	3RT1054 S6	3RT1055	3RT1056	3RT1064 S10	3RT1065	3RT1066	3RT1075 S12	3RT1076	
<b>Rated data of the main contacts</b>									
<b>Load rating with AC</b>									
<b>Utilization category AC-3 and AC-3e</b>									
• Rated operational currents $I_e$									
- Up to 500 V	A	115	150	185	225	265	300	400	500
- At 690 V	A	115	150	170	225	265	280	400	450
- At 1 000 V	A	53	65	65	68	95	95	180	180
• Rated power for slip-ring or squirrel-cage motors at 50 and 60 Hz									
- At 230 V	kW	37	45	55	55	75	90	132	160
- At 400 V	kW	55	75	90	110	132	160	200	250
- At 500 V	kW	75	90	132	160	160	200	250	315
- At 690 V	kW	110	132	160	On request	On request	On request	400	400
- At 1 000 V	kW	75	90	160	200	132	132	250	250
<b>Thermal load capacity, 10 s current</b>	A	1 100	1 300	1 480	1 800	2 400		3 200	4 000
<b>Power loss per main conducting path at <math>I_e</math>/AC-3/AC-3e/400 V</b>	W	7	9	13	17	18	22	35	55
<b>Utilization category AC-4 (at <math>I_a = 6 \times I_e</math>)</b>									
Maximum values:									
• Rated operational current $I_e$									
- Up to 400 V	A	97	132	160	195	230	280	350	430
• Rated power for squirrel-cage motors at 50 Hz and 60 Hz									
- At 400 V	kW	55	75	90	110	132	160	200	250
The following applies to a contact endurance of about 200 000 operating cycles:									
• Rated operational currents $I_e$									
- Up to 500 V	A	54	68	81	96	117	125	150	175
- Up to 690 V	A	48	57	65	85	105	115	135	150
• Rated power for squirrel-cage motors at 50 Hz and 60 Hz									
- At 230 V	kW	16	20	25	30	37	40	48	56
- At 400 V	kW	29	38	45	54	66	71	85	98
- At 500 V	kW	37	47	57	67	82	87	105	123
- At 690 V	kW	48	55	65	82	102	112	133	148

# Switching devices – Contactors and contactor assemblies – for switching motors

## Power contactors for switching motors

### SIRIUS 3RT contactors, 3-pole up to 250 kW

Type	Contactors		
Size	3RT105. S6	3RT106. S10	3RT107. S12
<b>Conductor cross-sections</b>			
<b>Main conductors</b> (1 or 2 conductors can be connected)			
 <b>Screw terminals</b>			
With mounted box terminals	Type	3RT1955-4G (55 kW)	3RT1956-4G
<ul style="list-style-type: none"> <li>Terminal screws</li> <li>- Tightening torque</li> </ul>	Nm	M10 (hexagon socket, A/F 4)	M12 (hexagon socket, A/F 5)
	lb.in	10 ... 12	20 ... 22
		90 ... 110	180 ... 195
Front clamping point connected			
 <ul style="list-style-type: none"> <li>Finely stranded with end sleeve (DIN 46228)</li> <li>Finely stranded without end sleeve</li> <li>Stranded</li> <li>AWG cables, solid or stranded</li> <li>Ribbon cable conductors (number x width x thickness)</li> </ul>	mm <sup>2</sup>	16 ... 70	16 ... 120
	mm <sup>2</sup>	16 ... 70	16 ... 120
	mm <sup>2</sup>	16 ... 70	16 ... 120
	AWG	6 ... 2/0	6 ... 250 kcmil
	mm	Min. 3 x 9 x 0,8, max. 6 x 15,5 x 0,8	Min. 3 x 9 x 0,8, max. 10 x 15,5 x 0,8
			70 ... 240
			70 ... 240
			95 ... 300
			3/0 ... 600 kcmil
			Min. 6 x 9 x 0,8, max. 20 x 24 x 0,5
Rear clamping point connected			
 <ul style="list-style-type: none"> <li>Finely stranded with end sleeve (DIN 46228)</li> <li>Finely stranded without end sleeve</li> <li>Stranded</li> <li>AWG cables, solid or stranded</li> <li>Ribbon cable conductors (number x width x thickness)</li> </ul>	mm <sup>2</sup>	16 ... 70	16 ... 120
	mm <sup>2</sup>	16 ... 70	16 ... 120
	mm <sup>2</sup>	16 ... 70	16 ... 120
	AWG	6 ... 2/0	6 ... 250 kcmil
	mm	Min. 3 x 9 x 0,8, max. 6 x 15,5 x 0,8	Min. 3 x 9 x 0,8, max. 10 x 15,5 x 0,8
			120 ... 185
			120 ... 185
			120 ... 240
			250 ... 500 kcmil
			Min. 6 x 9 x 0,8, max. 20 x 24 x 0,5
Both clamping points connected (minimum cross-section 16 mm <sup>2</sup> )			
 <ul style="list-style-type: none"> <li>Finely stranded with end sleeve (DIN 46228)</li> <li>Finely stranded without end sleeve</li> <li>Stranded</li> <li>AWG cables, solid or stranded</li> <li>Ribbon cable conductors (number x width x thickness)</li> </ul>	mm <sup>2</sup>	Max. 1 x 50, 1 x 70	Max. 1 x 95, 1 x 120
	mm <sup>2</sup>	Max. 1 x 50, 1 x 70	Max. 1 x 95, 1 x 120
	mm <sup>2</sup>	Max. 1 x 50, 1 x 70	Max. 1 x 95, 1 x 120
	AWG	Max. 2 x 1/0	Max. 2 x 3/0
	mm	Max. 2 x (6 x 15,5 x 0,8)	Max. 2 x (10 x 15,5 x 0,8)
			Min. 2 x 50, max. 2 x 185
			Min. 2 x 50, max. 2 x 185
			Min. 2 x 70, max. 2 x 240
			Min. 2 x 2/0, max. 2 x 500 kcmil
			Max. 2 x (20 x 24 x 0,5)
<b>Busbar connections</b>			
Connecting bar (max. width)	mm	17	25
Cable lug connection			
<ul style="list-style-type: none"> <li>Finely stranded with cable lug<sup>1)2)</sup></li> <li>Stranded with cable lug<sup>1)2)</sup></li> <li>AWG cables, solid or stranded</li> <li>Terminal screws</li> <li>- Tightening torque</li> </ul>	mm <sup>2</sup>	16 ... 95	50 ... 240
	mm <sup>2</sup>	25 ... 120	70 ... 240
	AWG	4 ... 250 kcmil	2/0 ... 500 kcmil
	Nm	M8 x 25 (A/F 13)	M10 x 30 (A/F 17)
	lb.in	10 ... 14	14 ... 24
		90 ... 124	124 ... 210
<b>Auxiliary conductors</b> (1 or 2 conductors can be connected)			
<ul style="list-style-type: none"> <li>Solid</li> <li>Finely stranded with end sleeve (DIN 46228)</li> <li>AWG cables, solid or stranded</li> <li>Terminal screws</li> <li>- Tightening torque</li> </ul>	mm <sup>2</sup>	2 x (0,5 ... 1,5) <sup>3)</sup> ; 2 x (0,75 ... 2,5) <sup>3)</sup> ; max. 2 x (0,75 ... 4) <sup>3)</sup>	
	mm <sup>2</sup>	2 x (0,5 ... 1,5) <sup>3)</sup> ; 2 x (0,75 ... 2,5) <sup>3)</sup>	
	AWG	2 x (18 ... 14)	
	Nm	M3 (Poizidriv size 2)	
	lb.in	0,8 ... 1,2	
		7 ... 10,3	
<b>Auxiliary conductors<sup>4)</sup></b> (1 or 2 conductors can be connected)			
 <b>Spring-loaded terminals</b>			
<ul style="list-style-type: none"> <li>Operating devices</li> <li>Solid</li> <li>Finely stranded with end sleeve (DIN 46228)</li> <li>Finely stranded without end sleeve</li> <li>AWG cables, solid or stranded</li> </ul>		3,0 x 0,5; 3,5 x 0,5	
	mm <sup>2</sup>	2 x (0,25 ... 2,5)	
	mm <sup>2</sup>	2 x (0,25 ... 1,5)	
	mm <sup>2</sup>	2 x (0,25 ... 2,5)	
	AWG	2 x (24 ... 14)	

<sup>1)</sup> 3RT105.: When using cable lugs according to DIN 46235, use the 3RT1956-4EA1 terminal cover for conductor cross-sections from 95 mm<sup>2</sup> to maintain the phase clearance; see page 3/112.

<sup>2)</sup> 3RT106. and 3RT107.: When connecting cable lugs according to DIN 46234 for conductor cross-sections larger than 240 mm<sup>2</sup> and according to DIN 46235 for conductor cross-sections larger than 185 mm<sup>2</sup>, the 3RT1966-4EA1 terminal cover is required to maintain the phase clearance; see page 3/112.

<sup>3)</sup> If two different conductor cross-sections are connected to one clamping point, both cross-sections must lie in one of the ranges specified.

<sup>4)</sup> Max. outer diameter of the conductor insulation: 3.6 mm. On spring-loaded terminals with conductor cross-sections ≤ 1 mm<sup>2</sup>, an insulation stop is recommended; see page 3/115.

# Switching devices – Contactors and contactor assemblies – for switching motors

## Power contactors for switching motors

### SIRIUS 3RT contactors, 3-pole up to 250 kW

#### Data for North America

Type Size	Contactors			
	3RT2015 S00	3RT2016	3RT2017	3RT2018
<b>Ⓢ and Ⓣ rated data</b>				
<b>Rated operational voltage</b>	V AC	600		
<b>Uninterrupted current</b> , at 40 °C, open and enclosed	A	20		
<b>Maximum horsepower ratings</b> (from Ⓢ and Ⓣ approved values)				
• Rated power for three-phase motors at 60 Hz	at 200 V hp 230 V hp 460 V hp 575 V hp	1.5 2 3 5	2 3 5 7.5	3 7.5 10 10
<b>Short-circuit protection</b> (contactor)				
• Class J fuse (values for RK5 fuses available on request)	A	60		
• Circuit breakers in accordance with UL 489 ("Inverse Time Breakers")	A	50		
• Combination Motor Controllers (Type E) according to UL 508 and UL 60947-4-1		3RV2.1 or 3RV2.2		

Type Size	Contactors						
	3RT2023 S0	3RT2024	3RT2025	3RT2026	3RT2326-.....-4AA0	3RT2027 3RT2028	
<b>Ⓢ and Ⓣ rated data</b>							
<b>Rated operational voltage</b>	V AC	600					
<b>Uninterrupted current</b> , at 40 °C, open and enclosed	A	30					42
<b>Maximum horsepower ratings</b> (from Ⓢ and Ⓣ approved values)							
• Rated power for three-phase motors at 60 Hz	at 200 V hp 230 V hp 460 V hp 575 V hp	2 3 5 7.5	3 7.5 10	5 10 15	5 7.5 15	3 5 10 15	10 10 20 25
<b>Short-circuit protection</b> (contactor)							
• Class J fuse (values for RK5 fuses available on request)	A	125					150
• Circuit breakers in accordance with UL 489 ("Inverse Time Breakers")	A	70					100
• Combination Motor Controllers (Type E) according to UL 508 and UL 60947-4-1	at 480 V Type at 600 V Type	3RV202					

Type Size	Contactors							
	3RT2035 S2	3RT2036, 3RT2336-.....-4AA0	3RT2037	3RT2038	3RT2045	3RT2046	3RT2047 S3	
<b>Ⓢ and Ⓣ rated data</b>								
<b>Rated operational voltage</b>	V AC	600						
<b>Uninterrupted current</b> , at 40 °C, open and enclosed	A	55	60	80	90	62	77	99
<b>Maximum horsepower ratings</b> (from Ⓢ and Ⓣ approved values)								
• Rated power for three-phase motors at 60 Hz	at 200/208 V hp 230/240 V hp 460/480 V hp 575/600 V hp	10 15 30 40	15 40 50	20 25 50	25 60 60	25 30 60 75	30 40 75 100	
<b>Short-circuit protection</b> (contactor)								
• RK5 fuse	A	150	200	250		300	350	
• Combination Motor Controllers (Type E) according to UL 508 and UL 60947-4-1	Type	3RV203					3RV204	

## Switching devices – Contactors and contactor assemblies – for switching motors

### Power contactors for switching motors

#### SIRIUS 3RT contactors, 3-pole up to 250 kW

Type Size	Contactors							
	3RT1054 S6	3RT1055	3RT1056	3RT1064 S10	3RT1065	3RT1066	3RT1075 S12	3RT1076
<b>Ⓢ and Ⓜ rated data</b>								
<b>Rated operational voltage</b>	V AC	600						
<b>Uninterrupted current</b> , at 40 °C, open and enclosed	A	140	195	250	330	400	540	
<b>Maximum horsepower ratings</b> (from Ⓢ and Ⓜ approved values)								
• Rated power for three-phase motors at 60 Hz	at 200 V hp	40	50	60	75	100	125	150
	230 V hp	50	60	75	100	125	150	200
	460 V hp	100	125	150	200	250	300	400
	575 V hp	125	150	200	250	300	400	500
<b>Short-circuit protection</b>	For more information, see <a href="#">Certificate of Compliance for the individual devices</a> . For the dimensioning of load feeders, see <a href="#">Configuration Manual</a> .							

Type Size	Contactors			
	3RT201 S00	3RT202 to 3RT204 S0 to S3	Mountable auxiliary switch	3RT105 to 3RT107 S6 to S12
	Integrated or mountable auxiliary switch	Integrated	Mountable auxiliary switch	Mountable auxiliary switch
<b>Ⓢ and Ⓜ rated data of the auxiliary contacts</b>				
<b>Rated voltage</b>	V AC	600		
<b>Switching capacity</b>		A 600, Q 600	A 600, P 600	A 600, Q 600
• Uninterrupted current at 240 V AC	A	10		

# Switching devices – Contactors and contactor assemblies – for switching motors

## Power contactors for switching motors

AC-3e

IE3/IE4 ready

SIRIUS 3RT contactors, 3-pole up to 250 kW

### Selection and ordering data

#### AC operation

PU (UNIT, SET, M) = 1  
 PS\* = 1 unit  
 PG = 41B



3RT201.-1A...





3RT201.-2A...



3RT201.-1AP04-3MA0



3RT201.-2AP04-3MA0

Rated data		Auxiliary contacts	Rated control supply voltage $U_s$	Screw terminals 	Spring-loaded terminals 
AC-3 and AC-3e, $t_u$ : 60 °C		Ident. No.	50/60 Hz AC	Article No.	Article No.
Operational current $I_e$ up to 400 V	Ratings of three-phase motors at 50 Hz and 400 V	Version		Price per PU	Price per PU
A	kW	NO NC V			

#### For screw fixing and snap-on mounting on TH 35 DIN rail

#### Size S00

7	3	18	10	1	--	24 110 230	3RT2015-1AB01 3RT2015-1AF01 3RT2015-1AP01	3RT2015-2AB01 3RT2015-2AF01 3RT2015-2AP01	
			01	--	1	24 110 230	3RT2015-1AB02 3RT2015-1AF02 3RT2015-1AP02	3RT2015-2AB02 3RT2015-2AF02 3RT2015-2AP02	
9	4	22	10	1	--	24 110 230	3RT2016-1AB01 3RT2016-1AF01 3RT2016-1AP01	3RT2016-2AB01 3RT2016-2AF01 3RT2016-2AP01	
			01	--	1	24 110 230	3RT2016-1AB02 3RT2016-1AF02 3RT2016-1AP02	3RT2016-2AB02 3RT2016-2AF02 3RT2016-2AP02	
12	5.5	22	10	1	--	24 110 230	3RT2017-1AB01 3RT2017-1AF01 3RT2017-1AP01	3RT2017-2AB01 3RT2017-2AF01 3RT2017-2AP01	
			01	--	1	24 110 230	3RT2017-1AB02 3RT2017-1AF02 3RT2017-1AP02	3RT2017-2AB02 3RT2017-2AF02 3RT2017-2AP02	
16	7.5	22	10	1	--	24 110 230	3RT2018-1AB01 3RT2018-1AF01 3RT2018-1AP01	3RT2018-2AB01 3RT2018-2AF01 3RT2018-2AP01	
			01	--	1	24 110 230	3RT2018-1AB02 3RT2018-1AF02 3RT2018-1AP02	3RT2018-2AB02 3RT2018-2AF02 3RT2018-2AP02	
<b>With permanently mounted auxiliary switch</b>									
7	3	18	22	2	2	230	3RT2015-1AP04-3MA0	3RT2015-2AP04-3MA0	
9	4	22	22	2	2	230	3RT2016-1AP04-3MA0	3RT2016-2AP04-3MA0	
12	5.5	22	22	2	2	230	3RT2017-1AP04-3MA0	3RT2017-2AP04-3MA0	
16	7.5	22	22	2	2	230	3RT2018-1AP04-3MA0	3RT2018-2AP04-3MA0	
<b>With permanently mounted auxiliary switch and varistor plugged into the front</b>									
7	3	18	22	2	2	230	3RT2015-1CP04-3MA0	3RT2015-2CP04-3MA0	
9	4	22	22	2	2	230	3RT2016-1CP04-3MA0	3RT2016-2CP04-3MA0	
12	5.5	22	22	2	2	230	3RT2017-1CP04-3MA0	3RT2017-2CP04-3MA0	
16	7.5	22	22	2	2	230	3RT2018-1CP04-3MA0	3RT2018-2CP04-3MA0	

Other voltages according to page 3/67 on request.

Accessories and spare parts, see pages 3/69 to 3/119.

# Switching devices – Contactors and contactor assemblies – for switching motors

## Power contactors for switching motors

**SIRIUS 3RT contactors, 3-pole up to 250 kW**
**IE3/IE4 ready**
**AC-3e**
**AC operation** 

PU (UNIT, SET, M) = 1  
 PS\* = 1 unit  
 PG = 41B



3RT202-1A.00



3RT202-2A.00

Rated data		Auxiliary contacts		Rated control supply voltage $U_s$	
AC-3 and AC-3e, $t_u$ : 60 °C	AC-1, $t_u$ : 40 °C	Ident. No.	Version	50 Hz AC	
Operational current $I_e$ up to 400 V	Ratings of three-phase motors at 50 Hz and 400 V				
	<b>400 V</b>				
A	<b>kW</b>	A	NO NC V	Article No.	Price per PU

**Screw terminals** 
**Spring-loaded terminals** 
**For screw fixing and snap-on mounting on TH 35 DIN rail**
**Size S0**

Size	Rated current $I_e$ (A)	Rated power (kW)	Ident. No.	Version	Control voltage $U_s$ (V)	Article No. (Screw)	Article No. (Spring)
9	4	40	11	1	24	3RT2023-1AB00	3RT2023-2AB00
					110	3RT2023-1AF00	3RT2023-2AF00
					230	3RT2023-1AP00	3RT2023-2AP00
12	5.5	40	11	1	24	3RT2024-1AB00	3RT2024-2AB00
					110	3RT2024-1AF00	3RT2024-2AF00
					230	3RT2024-1AP00	3RT2024-2AP00
17	7.5	40	11	1	24	3RT2025-1AB00	3RT2025-2AB00
					110	3RT2025-1AF00	3RT2025-2AF00
					230	3RT2025-1AP00	3RT2025-2AP00
25	11	40	11	1	24	3RT2026-1AB00	3RT2026-2AB00
					110	3RT2026-1AF00	3RT2026-2AF00
					230	3RT2026-1AP00	3RT2026-2AP00
32	15	50	11	1	24	3RT2027-1AB00	3RT2027-2AB00
					110	3RT2027-1AF00	3RT2027-2AF00
					230	3RT2027-1AP00	3RT2027-2AP00
38	18.5	50	11	1	24	3RT2028-1AB00	3RT2028-2AB00
					110	3RT2028-1AF00	3RT2028-2AF00
					230	3RT2028-1AP00	3RT2028-2AP00

 Other voltages [according to page 3/67](#) on request.

 Accessories and spare parts, [see pages 3/69 to 3/119](#).



# Switching devices – Contactors and contactor assemblies – for switching motors

## Power contactors for switching motors

AC-3e

IE3/IE4 ready

SIRIUS 3RT contactors, 3-pole up to 250 kW

### AC operation

PU (UNIT, SET, M) = 1  
 PS\* = 1 unit  
 PG = 41B



3RT202.-1A.04





3RT202.-2A.04

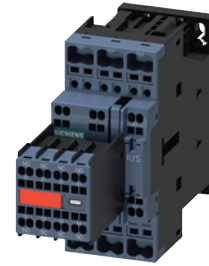

3RT202.-1CL24-3MA0



3RT202.-2CL24-3MA0

Rated data		Auxiliary contacts		Rated control supply voltage $U_s$	Screw terminals 	Spring-loaded terminals 
AC-3 and AC-3e, $t_{ij}$ : 60 °C	AC-1, $t_{ij}$ : 40 °C	Ident. No.	Version	50 Hz AC	Article No.	Article No.
Operational current $I_e$ up to 400 V	Operational current $I_e$ up to 690 V	 NO NC V			Price per PU	Price per PU
A	kW	A				

For screw fixing and snap-on mounting on TH 35 DIN rail

### Size S0

#### With removable auxiliary switch

9	4	40	22	2	2	24 110 230	3RT2023-1AB04 3RT2023-1AP04	3RT2023-2AB04 3RT2023-2AP04
12	5.5	40	22	2	2	24 110 230	3RT2024-1AB04 3RT2024-1AF04 3RT2024-1AP04	3RT2024-2AB04 3RT2024-2AF04 3RT2024-2AP04
17	7.5	40	22	2	2	24 110 230	3RT2025-1AB04 3RT2025-1AF04 3RT2025-1AP04	3RT2025-2AB04 3RT2025-2AF04 3RT2025-2AP04
25	11	40	22	2	2	24 110 230	3RT2026-1AB04 3RT2026-1AF04 3RT2026-1AP04	3RT2026-2AB04 3RT2026-2AF04 3RT2026-2AP04
32	15	50	22	2	2	24 110 230	3RT2027-1AB04 3RT2027-1AF04 3RT2027-1AP04	3RT2027-2AB04 3RT2027-2AF04 3RT2027-2AP04
38	18.5	50	22	2	2	24 110 230	3RT2028-1AB04 3RT2028-1AF04 3RT2028-1AP04	3RT2028-2AB04 3RT2028-2AF04 3RT2028-2AP04

#### With permanently mounted auxiliary switch and varistor plugged in

9	4	40	22	2	2	230	3RT2023-1CL24-3MA0	3RT2023-2CL24-3MA0
12	5.5	40	22	2	2	230	3RT2024-1CL24-3MA0	3RT2024-2CL24-3MA0
17	7.5	40	22	2	2	230	3RT2025-1CL24-3MA0	3RT2025-2CL24-3MA0
25	11	40	22	2	2	230	3RT2026-1CL24-3MA0	3RT2026-2CL24-3MA0
32	15	50	22	2	2	230	3RT2027-1CL24-3MA0	3RT2027-2CL24-3MA0
38	18.5	50	22	2	2	230	3RT2028-1CL24-3MA0	3RT2028-2CL24-3MA0

Other voltages according to page 3/67 on request.

Accessories and spare parts, see pages 3/69 to 3/119.

# Switching devices – Contactors and contactor assemblies – for switching motors

## Power contactors for switching motors

SIRIUS 3RT contactors, 3-pole up to 250 kW **IE3/IE4 ready** **AC-3e**

### AC operation

PU (UNIT, SET, M) = 1  
 PS\* = 1 unit  
 PG = 41B



3RT203.-1A.00



3RT203.-3A.00





3RT203.-1A.04



3RT203.-3CL24-3MA0



3RT203.-1CL24-3MA0

Rated data		Auxiliary contacts		Rated control supply voltage		Screw terminals 		Spring-loaded terminals 	
AC-3 and AC-3e, $t_{ij}$ : 60 °C		AC-1, $t_{ij}$ : 40 °C		50 Hz AC		Article No.		Article No.	
Operational current $I_e$ up to 400 V	Ratings of three-phase motors at 50 Hz and 400 V	Operational current $I_e$ up to 690 V	Ident. No.	Version		Price per PU	Price per PU		
A	<b>kW</b>	A							
			NO	NC	V				

For screw fixing and snap-on mounting on TH 35 DIN rail

#### Size S2

41	<b>18.5</b>	60	<b>11</b>	1	1	24 110 230	3RT2035-1AB00 3RT2035-1AF00 3RT2035-1AP00	3RT2035-3AB00 3RT2035-3AF00 3RT2035-3AP00	
51	<b>22</b>	70	<b>11</b>	1	1	24 110 230	3RT2036-1AB00 3RT2036-1AF00 3RT2036-1AP00	3RT2036-3AB00 3RT2036-3AF00 3RT2036-3AP00	
65	<b>30</b>	80	<b>11</b>	1	1	24 110 230	3RT2037-1AB00 3RT2037-1AF00 3RT2037-1AP00	3RT2037-3AB00 3RT2037-3AF00 3RT2037-3AP00	
80	<b>37</b>	90	<b>11</b>	1	1	24 110 230	3RT2038-1AB00 3RT2038-1AF00 3RT2038-1AP00	3RT2038-3AB00 3RT2038-3AF00 3RT2038-3AP00	
<b>With removable auxiliary switch</b>									
41	<b>18.5</b>	60	<b>22</b>	2	2	24 110 230	3RT2035-1AB04 3RT2035-1AF04 3RT2035-1AP04	-- -- --	
51	<b>22</b>	70	<b>22</b>	2	2	24 110 230	3RT2036-1AB04 3RT2036-1AF04 3RT2036-1AP04	-- -- --	
65	<b>30</b>	80	<b>22</b>	2	2	24 110 230	3RT2037-1AB04 3RT2037-1AF04 3RT2037-1AP04	-- -- --	
80	<b>37</b>	90	<b>22</b>	2	2	24 110 230	3RT2038-1AB04 3RT2038-1AF04 3RT2038-1AP04	-- -- --	
<b>With permanently mounted auxiliary switch and integrated coil circuit (varistor plugged in at the factory)</b>									
41	<b>18.5</b>	60	<b>22</b>	2	2	230	3RT2035-1CL24-3MA0	3RT2035-3CL24-3MA0	
51	<b>22</b>	70	<b>22</b>	2	2	230	3RT2036-1CL24-3MA0	3RT2036-3CL24-3MA0	
65	<b>30</b>	80	<b>22</b>	2	2	230	3RT2037-1CL24-3MA0	3RT2037-3CL24-3MA0	
80	<b>37</b>	90	<b>22</b>	2	2	230	3RT2038-1CL24-3MA0	3RT2038-3CL24-3MA0	

Other voltages [according to page 3/67](#) on request.

Accessories and spare parts, [see pages 3/69 to 3/119](#).

# Switching devices – Contactors and contactor assemblies – for switching motors

## Power contactors for switching motors

AC-3e

IE3/IE4 ready

SIRIUS 3RT contactors, 3-pole up to 250 kW

**AC operation** 

PU (UNIT, SET, M) = 1  
 PS\* = 1 unit  
 PG = 41B



3RT204.-1A.00





3RT204.-1A.04





3RT204.-1CL24-3MA0



3RT204.-3A.00

Rated data		Auxiliary contacts	Rated control supply voltage
AC-3 and AC-3e, $t_u$ : 60 °C	AC-1, $t_u$ : 40 °C	Ident. No.	$U_s$
Operational current $I_e$ up to 400 V	Operational current $I_e$ up to 690 V	Version	50 Hz AC
Ratings of three-phase motors at 50 Hz and 400 V		 	
<b>400 V</b>		NO NC V	
<b>A</b>	<b>kW</b>		

Screw terminals 	
Article No.	Price per PU

Spring-loaded terminals 	
Article No.	Price per PU

For screw fixing and snap-on mounting on TH 35-15 and TH 75-15 DIN rails

**Size S3**

80	<b>37</b>	125	<b>11</b>	1	1	24 110 230	3RT2045-1AB00 3RT2045-1AF00 3RT2045-1AP00	3RT2045-3AB00 3RT2045-3AF00 3RT2045-3AP00	
95	<b>45</b>	130	<b>11</b>	1	1	24 110 230	3RT2046-1AB00 3RT2046-1AF00 3RT2046-1AP00	3RT2046-3AB00 3RT2046-3AF00 3RT2046-3AP00	
110	<b>55</b>	130	<b>11</b>	1	1	24 110 230	3RT2047-1AB00 3RT2047-1AF00 3RT2047-1AP00	3RT2047-3AB00 3RT2047-3AF00 3RT2047-3AP00	
<b>With removable auxiliary switch</b>									
80	<b>37</b>	125	<b>22</b>	2	2	24 110 230	3RT2045-1AB04 3RT2045-1AF04 3RT2045-1AP04	-- -- --	
95	<b>45</b>	130	<b>22</b>	2	2	24 110 230	3RT2046-1AB04 3RT2046-1AF04 3RT2046-1AP04	-- -- --	
110	<b>55</b>	130	<b>22</b>	2	2	24 110 230	3RT2047-1AB04 3RT2047-1AF04 3RT2047-1AP04	-- -- --	
<b>With permanently mounted auxiliary switch and integrated coil circuit (varistor plugged in at the factory)</b>									
80	<b>37</b>	125	<b>22</b>	2	2	230	3RT2045-1CL24-3MA0	--	
95	<b>45</b>	130	<b>22</b>	2	2	230	3RT2046-1CL24-3MA0	--	
110	<b>55</b>	130	<b>22</b>	2	2	230	3RT2047-1CL24-3MA0	--	

Other voltages [according to page 3/67](#) on request.

Accessories and spare parts, [see pages 3/69 to 3/119](#).

# Switching devices – Contactors and contactor assemblies – for switching motors

## Power contactors for switching motors

**SIRIUS 3RT contactors, 3-pole up to 250 kW**
**IE3/IE4 ready**
**AC-3e**
**DC operation**

PU (UNIT, SET, M) = 1  
 PS\* = 1 unit  
 PG = 41B



3RT201.-1B...



3RT201.-2B...

Rated data		Auxiliary contacts		Rated control supply voltage $U_s$		Screw terminals		Spring-loaded terminals	
AC-3 and AC-3e, $t_U$ : 60 °C		AC-1, $t_U$ : 40 °C		DC		+		⊕	
Operational current $I_e$ up to	Ratings of three-phase motors at 50 Hz and	Operational current $I_e$ up to	Ident. No.	Version	DC	Article No.	Price per PU	Article No.	Price per PU
400 V	<b>400 V</b>	690 V							
A	<b>kW</b>	A							
			NO	NC	V				

**For screw fixing and snap-on mounting on TH 35 DIN rail**
**Size S00**

7	<b>3</b>	18	<b>10</b>	1	--	24	<b>3RT2015-1BB41</b>	<b>3RT2015-2BB41</b>
			<b>01</b>	--	1	24	<b>3RT2015-1BM41</b>	<b>3RT2015-2BM41</b>
						220	<b>3RT2015-1BB42</b>	<b>3RT2015-2BB42</b>
						220	<b>3RT2015-1BM42</b>	<b>3RT2015-2BM42</b>
9	<b>4</b>	22	<b>10</b>	1	--	24	<b>3RT2016-1BB41</b>	<b>3RT2016-2BB41</b>
			<b>01</b>	--	1	24	<b>3RT2016-1BM41</b>	<b>3RT2016-2BM41</b>
						220	<b>3RT2016-1BB42</b>	<b>3RT2016-2BB42</b>
						220	<b>3RT2016-1BM42</b>	<b>3RT2016-2BM42</b>
12	<b>5.5</b>	22	<b>10</b>	1	--	24	<b>3RT2017-1BB41</b>	<b>3RT2017-2BB41</b>
			<b>01</b>	--	1	24	<b>3RT2017-1BM41</b>	<b>3RT2017-2BM41</b>
						220	<b>3RT2017-1BB42</b>	<b>3RT2017-2BB42</b>
						220	<b>3RT2017-1BM42</b>	<b>3RT2017-2BM42</b>
16	<b>7.5</b>	22	<b>10</b>	1	--	24	<b>3RT2018-1BB41</b>	<b>3RT2018-2BB41</b>
			<b>01</b>	--	1	24	<b>3RT2018-1BM41</b>	<b>3RT2018-2BM41</b>
						220	<b>3RT2018-1BB42</b>	<b>3RT2018-2BB42</b>
						220	<b>3RT2018-1BM42</b>	<b>3RT2018-2BM42</b>
<b>With integrated coil circuit (varistor integrated at the factory)</b>								
7	<b>3</b>	18	<b>10</b>	1	--	24	<b>3RT2015-1UB41</b>	<b>3RT2015-2UB41</b>
			<b>01</b>	--	1	24	<b>3RT2015-1UB42</b>	<b>3RT2015-2UB42</b>
9	<b>4</b>	22	<b>10</b>	1	--	24	<b>3RT2016-1UB41</b>	<b>3RT2016-2UB41</b>
			<b>01</b>	--	1	24	<b>3RT2016-1UB42</b>	<b>3RT2016-2UB42</b>
12	<b>5.5</b>	22	<b>10</b>	1	--	24	<b>3RT2017-1UB41</b>	<b>3RT2017-2UB41</b>
			<b>01</b>	--	1	24	<b>3RT2017-1UB42</b>	<b>3RT2017-2UB42</b>
16	<b>7.5</b>	22	<b>10</b>	1	--	24	<b>3RT2018-1UB41</b>	<b>3RT2018-2UB41</b>
			<b>01</b>	--	1	24	<b>3RT2018-1UB42</b>	<b>3RT2018-2UB42</b>
<b>With integrated coil circuit (diode integrated at factory)</b>								
7	<b>3</b>	18	<b>10</b>	1	--	24	<b>3RT2015-1FB41</b>	<b>3RT2015-2FB41</b>
			<b>01</b>	--	1	24	<b>3RT2015-1FB42</b>	<b>3RT2015-2FB42</b>
9	<b>4</b>	22	<b>10</b>	1	--	24	<b>3RT2016-1FB41</b>	<b>3RT2016-2FB41</b>
			<b>01</b>	--	1	24	<b>3RT2016-1FB42</b>	<b>3RT2016-2FB42</b>
12	<b>5.5</b>	22	<b>10</b>	1	--	24	<b>3RT2017-1FB41</b>	<b>3RT2017-2FB41</b>
			<b>01</b>	--	1	24	<b>3RT2017-1FB42</b>	<b>3RT2017-2FB42</b>
16	<b>7.5</b>	22	<b>10</b>	1	--	24	<b>3RT2018-1FB41</b>	<b>3RT2018-2FB41</b>
			<b>01</b>	--	1	24	<b>3RT2018-1FB42</b>	<b>3RT2018-2FB42</b>

 Other voltages [according to page 3/67](#) on request.

 Accessories and spare parts, [see pages 3/69 to 3/119](#).

# Switching devices – Contactors and contactor assemblies – for switching motors

## Power contactors for switching motors

AC-3e

IE3/IE4 ready

SIRIUS 3RT contactors, 3-pole up to 250 kW

**DC operation** 

PU (UNIT, SET, M) = 1  
 PS\* = 1 unit  
 PG = 41B



3RT201.-1BB44-3MA0



3RT201.-2BB44-3MA0



3RT201.-1BB4.-0CC0



3RT201.-2BB4.-0CC0

## Rated data

AC-3 and AC-3e,  
 $t_u$ : 60 °COperational current  $I_e$   
up to  
400 V

A

Ratings of  
three-phase  
motors at  
50 Hz and**400 V**

kW

AC-1,  
 $t_u$ : 40 °COperational  
current  $I_e$   
up to  
690 V

A

## Auxiliary contacts

Ident.  
No.

Version



NO NC V

Rated control  
supply  
voltage  $U_s$ 

DC

Screw terminals 

Article No.

Price  
per PUSpring-loaded terminals 

Article No.

Price  
per PU**For screw fixing and snap-on mounting on TH 35 DIN rail****Size S00****With permanently mounted auxiliary switch**

7	<b>3</b>	18	<b>22</b>	2	2	24
9	<b>4</b>	22	<b>22</b>	2	2	24
12	<b>5.5</b>	22	<b>22</b>	2	2	24
16	<b>7.5</b>	22	<b>22</b>	2	2	24

3RT2015-1BB44-3MA0

3RT2015-2BB44-3MA0

3RT2016-1BB44-3MA0

3RT2016-2BB44-3MA0

3RT2017-1BB44-3MA0

3RT2017-2BB44-3MA0

3RT2018-1BB44-3MA0

3RT2018-2BB44-3MA0

**With permanently mounted auxiliary switch and integrated coil circuit  
(diode integrated at the factory)**

7	<b>3</b>	18	<b>22</b>	2	2	24
9	<b>4</b>	22	<b>22</b>	2	2	24
12	<b>5.5</b>	22	<b>22</b>	2	2	24
16	<b>7.5</b>	22	<b>22</b>	2	2	24

3RT2015-1FB44-3MA0

3RT2015-2FB44-3MA0

3RT2016-1FB44-3MA0

3RT2016-2FB44-3MA0

3RT2017-1FB44-3MA0

3RT2017-2FB44-3MA0

3RT2018-1FB44-3MA0

3RT2018-2FB44-3MA0

**With voltage tap-off (only available with 24 V DC coils)**

7	<b>3</b>	18	<b>10</b>	1	--	24
			<b>01</b>	--	1	24
9	<b>4</b>	22	<b>10</b>	1	--	24
			<b>01</b>	--	1	24
12	<b>5.5</b>	22	<b>10</b>	1	--	24
			<b>01</b>	--	1	24
16	<b>7.5</b>	22	<b>10</b>	1	--	24
			<b>01</b>	--	1	24

3RT2015-1BB41-0CC0

3RT2015-2BB41-0CC0

3RT2015-1BB42-0CC0

3RT2015-2BB42-0CC0

3RT2016-1BB41-0CC0

3RT2016-2BB41-0CC0

3RT2016-1BB42-0CC0

3RT2016-2BB42-0CC0

3RT2017-1BB41-0CC0

3RT2017-2BB41-0CC0

3RT2017-1BB42-0CC0

3RT2017-2BB42-0CC0

3RT2018-1BB41-0CC0

3RT2018-2BB41-0CC0

3RT2018-1BB42-0CC0

3RT2018-2BB42-0CC0

Other voltages [according to page 3/67](#) on request.Accessories and spare parts, [see pages 3/69 to 3/119](#).

# Switching devices – Contactors and contactor assemblies – for switching motors

## Power contactors for switching motors

SIRIUS 3RT contactors, 3-pole up to 250 kW **IE3/IE4 ready** **AC-3e**

### DC operation for direct control by PLC

- Coupling contactors with adapted power consumption
- Suitable for solid-state PLC/F-PLC outputs
- Cannot be expanded with auxiliary switches



PU (UNIT, SET, M) = 1  
 PS\* = 1 unit  
 PG = 41B



3RT201.-1.B4.



3RT201.-2.B4.

Rated data		Auxiliary contacts		Rated control supply voltage $U_s$	Screw terminals 	Spring-loaded terminals 
AC-3 and AC-3e, $t_u$ : 60 °C	AC-1, $t_u$ : 40 °C	Ident. No.	Version	DC	Article No.	Price per PU
Operational current $I_e$ up to 400 V	Ratings of three-phase motors at 50 Hz and 400 V					
A	<b>kW</b>	A	NO NC V			

### For screw fixing and snap-on mounting on TH 35 DIN rail

#### Size S00

(cannot be expanded with auxiliary switches)

Operating range **0.7 ... 1.25 x  $U_s$** ,

power consumption of the solenoid coils **2.8 W** at 24 V

7	<b>3</b>	18	<b>10</b>	1	--	24
			<b>01</b>	--	1	24
9	<b>4</b>	22	<b>10</b>	1	--	24
			<b>01</b>	--	1	24
12	<b>5.5</b>	22	<b>10</b>	1	--	24
			<b>01</b>	--	1	24

3RT2015-1HB41  
3RT2015-1HB42

3RT2015-2HB41  
3RT2015-2HB42

3RT2016-1HB41  
3RT2016-1HB42

3RT2016-2HB41  
3RT2016-2HB42

3RT2017-1HB41  
3RT2017-1HB42

3RT2017-2HB41  
3RT2017-2HB42

Operating range **0.85 ... 1.85 x  $U_s$** ,

power consumption of the solenoid coils **1.6 W** at 24 V

7	<b>3</b>	18	<b>10</b>	1	--	24
			<b>01</b>	--	1	24
9	<b>4</b>	22	<b>10</b>	1	--	24
			<b>01</b>	--	1	24
12	<b>5.5</b>	22	<b>10</b>	1	--	24
			<b>01</b>	--	1	24

3RT2015-1MB41-0KT0  
3RT2015-1MB42-0KT0

3RT2015-2MB41-0KT0  
3RT2015-2MB42-0KT0

3RT2016-1MB41-0KT0  
3RT2016-1MB42-0KT0

3RT2016-2MB41-0KT0  
3RT2016-2MB42-0KT0

3RT2017-1MB41-0KT0  
3RT2017-1MB42-0KT0

3RT2017-2MB41-0KT0  
3RT2017-2MB42-0KT0

#### With integrated coil circuit (diode integrated at factory)

(cannot be expanded with auxiliary switches)

Operating range **0.7 ... 1.25 x  $U_s$** ,

power consumption of the solenoid coils **2.8 W** at 24 V

7	<b>3</b>	18	<b>10</b>	1	--	24
			<b>01</b>	--	1	24
9	<b>4</b>	22	<b>10</b>	1	--	24
			<b>01</b>	--	1	24
12	<b>5.5</b>	22	<b>10</b>	1	--	24
			<b>01</b>	--	1	24

3RT2015-1JB41  
3RT2015-1JB42

3RT2015-2JB41  
3RT2015-2JB42

3RT2016-1JB41  
3RT2016-1JB42

3RT2016-2JB41  
3RT2016-2JB42

3RT2017-1JB41  
3RT2017-1JB42

3RT2017-2JB41  
3RT2017-2JB42

Operating range **0.85 ... 1.85 x  $U_s$** ,

power consumption of the solenoid coils **1.6 W** at 24 V

7	<b>3</b>	18	<b>10</b>	1	--	24
			<b>01</b>	--	1	24
9	<b>4</b>	22	<b>10</b>	1	--	24
			<b>01</b>	--	1	24
12	<b>5.5</b>	22	<b>10</b>	1	--	24
			<b>01</b>	--	1	24

3RT2015-1VB41  
3RT2015-1VB42

3RT2015-2VB41  
3RT2015-2VB42

3RT2016-1VB41  
3RT2016-1VB42

3RT2016-2VB41  
3RT2016-2VB42

3RT2017-1VB41  
3RT2017-1VB42

3RT2017-2VB41  
3RT2017-2VB42

Other voltages [according to page 3/67](#) on request.

Accessories and spare parts, [see pages 3/69 to 3/119](#).



# Switching devices – Contactors and contactor assemblies – for switching motors

## Power contactors for switching motors

AC-3e

IE3/IE4 ready

SIRIUS 3RT contactors, 3-pole up to 250 kW

### DC operation for direct control by PLC

- Coupling contactors with adapted power consumption
- Suitable for solid-state PLC/F-PLC outputs
- Cannot be expanded with auxiliary switches



PU (UNIT, SET, M) = 1  
 PS\* = 1 unit  
 PG = 41B





3RT201.-1.B4.



3RT201.-2.B4.

Rated data		Auxiliary contacts	Rated control supply voltage $U_s$	
AC-3 and AC-3e, $t_i$ : 60 °C		Ident. No.	DC	
Operational current $I_e$ up to	Ratings of three-phase motors at 50 Hz and		Version	
400 V	<b>400 V</b>			
A	<b>kW</b>	A	NO	NC V

Screw terminals 		Spring-loaded terminals 	
Article No.	Price per PU	Article No.	Price per PU

### For screw fixing and snap-on mounting on TH 35 DIN rail

#### Size S00

#### With integrated coil circuit (suppressor diode integrated at factory)

(cannot be expanded with auxiliary switches)

Operating range **0.7 ... 1.25 x  $U_s$** ,

power consumption of the solenoid coils **2.8 W** at 24 V

7	3	18	10 01	1 --	-- 1	24 24
9	4	22	10 01	1 --	-- 1	24 24
12	5.5	22	10 01	1 --	-- 1	24 24

Operating range **0.85 ... 1.85 x  $U_s$** ,

power consumption of the solenoid coils **1.6 W** at 24 V

7	3	18	10 01	1 --	-- 1	24 24
9	4	22	10 01	1 --	-- 1	24 24
12	5.5	22	10 01	1 --	-- 1	24 24

3RT2015-1KB41

3RT2015-1KB42

3RT2015-2KB41

3RT2015-2KB42

3RT2016-1KB41

3RT2016-1KB42

3RT2016-2KB41

3RT2016-2KB42

3RT2017-1KB41

3RT2017-1KB42

3RT2017-2KB41

3RT2017-2KB42

3RT2015-1SB41

3RT2015-1SB42

3RT2015-2SB41

3RT2015-2SB42

3RT2016-1SB41

3RT2016-1SB42

3RT2016-2SB41

3RT2016-2SB42

3RT2017-1SB41

3RT2017-1SB42

3RT2017-2SB41

3RT2017-2SB42

Other voltages [according to page 3/67](#) on request.

Accessories and spare parts, [see pages 3/69 to 3/119](#).

# Switching devices – Contactors and contactor assemblies – for switching motors

## Power contactors for switching motors

**SIRIUS 3RT contactors, 3-pole up to 250 kW**
**IE3/IE4 ready**
**AC-3e**
**DC operation**

PU (UNIT, SET, M) = 1  
 PS\* = 1 unit  
 PG = 41B



3RT202.-1B.40



3RT202.-2B.40



3RT202.-1B.44



3RT202.-2B.44

**Rated data**

 AC-3 and AC-3e,  
 $t_u$ : 60 °C

 Operational current  $I_e$   
 up to  
 400 V

A

 Ratings of  
 three-phase  
 motors at  
 50 Hz and  
**400 V**  
 kW

 AC-1,  
 $t_u$ : 40 °C

 Operational  
 current  $I_e$   
 up to  
 690 V

A

**Auxiliary contacts**

 Ident.  
 No.

Version

NO

NC

V

**Rated control  
 supply voltage**
 $U_s$ 

DC

**Screw terminals**

Article No.

 Price  
 per PU

**Spring-loaded terminals**

Article No.

 Price  
 per PU

**For screw fixing and snap-on mounting on TH 35 DIN rail**
**Size S0**

Size	Rated current $I_e$ (A)	Rated current $I_e$ (A)	Ident. No.	Version	Rated control supply voltage $U_s$ (DC)	Article No.	Article No.
9	4	40	11	1 1	24	3RT2023-1BB40	3RT2023-2BB40
12	5.5	40	11	1 1	24 220	3RT2024-1BB40 3RT2024-1BM40	3RT2024-2BB40 3RT2024-2BM40
17	7.5	40	11	1 1	24 220	3RT2025-1BB40 3RT2025-1BM40	3RT2025-2BB40 3RT2025-2BM40
25	11	40	11	1 1	24 220	3RT2026-1BB40 3RT2026-1BM40	3RT2026-2BB40 3RT2026-2BM40
32	15	50	11	1 1	24 220	3RT2027-1BB40 3RT2027-1BM40	3RT2027-2BB40 3RT2027-2BM40
38	18.5	50	11	1 1	24 220	3RT2028-1BB40 3RT2028-1BM40	3RT2028-2BB40 3RT2028-2BM40
<b>With coil circuit plugged into front (varistor plugged in at the factory)</b>							
9	4	40	11	1 1	24	3RT2023-1DB40	3RT2023-2DB40
12	5.5	40	11	1 1	24	3RT2024-1DB40	3RT2024-2DB40
17	7.5	40	11	1 1	24	3RT2025-1DB40	3RT2025-2DB40
25	11	40	11	1 1	24	3RT2026-1DB40	3RT2026-2DB40
32	15	50	11	1 1	24	3RT2027-1DB40	3RT2027-2DB40
38	18.5	50	11	1 1	24	3RT2028-1DB40	3RT2028-2DB40
<b>With coil circuit plugged into front (diode assembly plugged in at the factory)</b>							
9	4	40	11	1 1	24	3RT2023-1FB40	3RT2023-2FB40
12	5.5	40	11	1 1	24	3RT2024-1FB40	3RT2024-2FB40
17	7.5	40	11	1 1	24	3RT2025-1FB40	3RT2025-2FB40
25	11	40	11	1 1	24	3RT2026-1FB40	3RT2026-2FB40
32	15	50	11	1 1	24	3RT2027-1FB40	3RT2027-2FB40
38	18.5	50	11	1 1	24	3RT2028-1FB40	3RT2028-2FB40
<b>With removable auxiliary switch</b>							
9	4	40	22	2 2	24	3RT2023-1BB44	3RT2023-2BB44
12	5.5	40	22	2 2	24	3RT2024-1BB44	3RT2024-2BB44
17	7.5	40	22	2 2	24	3RT2025-1BB44	3RT2025-2BB44
25	11	40	22	2 2	24	3RT2026-1BB44	3RT2026-2BB44
32	15	50	22	2 2	24	3RT2027-1BB44	3RT2027-2BB44
38	18.5	50	22	2 2	24	3RT2028-1BB44	3RT2028-2BB44

 Other voltages [according to page 3/67](#) on request.

 Accessories and spare parts, [see pages 3/69 to 3/119](#).

# Switching devices – Contactors and contactor assemblies – for switching motors

## Power contactors for switching motors

AC-3e

IE3/IE4 ready

SIRIUS 3RT contactors, 3-pole up to 250 kW

**DC operation** 

PU (UNIT, SET, M) = 1  
 PS\* = 1 unit  
 PG = 41B



3RT202.-1.B44-3MA0

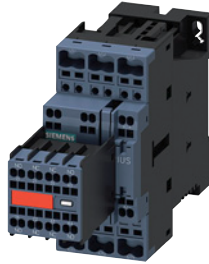





3RT202.-2.B44-3MA0



3RT202.-1BB40-0CC0



3RT202.-2BB40-0CC0

Rated data		Auxiliary contacts		Rated control supply voltage $U_s$	
AC-3 and AC-3e, $t_u$ : 60 °C	AC-1, $t_u$ : 40 °C	Ident. No.	Version	DC	
Operational current $I_e$ up to 400 V	Operational current $I_e$ up to 690 V				
Ratings of three-phase motors at 50 Hz and 400 V			NO	NC	V
<b>400 V</b>	A				
			<b>Screw terminals</b> 		<b>Spring-loaded terminals</b> 
			Article No.		Price per PU
			Article No.		Price per PU

For screw fixing and snap-on mounting on TH 35 DIN rail

**Size S0**

With permanently mounted auxiliary switch and integrated coil circuit (varistor integrated at the factory)

12	<b>5.5</b>	40	<b>22</b>	2	2	24
17	<b>7.5</b>	40	<b>22</b>	2	2	24
25	<b>11</b>	40	<b>22</b>	2	2	24
32	<b>15</b>	50	<b>22</b>	2	2	24

3RT2024-1DB44-3MA0
3RT2025-1DB44-3MA0
3RT2026-1DB44-3MA0
3RT2027-1DB44-3MA0

3RT2024-2DB44-3MA0
3RT2025-2DB44-3MA0
3RT2026-2DB44-3MA0
3RT2027-2DB44-3MA0

With permanently mounted auxiliary switch and integrated coil circuit (diode assembly plugged in at the factory)

9	<b>4</b>	40	<b>22</b>	2	2	24
12	<b>5.5</b>	40	<b>22</b>	2	2	24
17	<b>7.5</b>	40	<b>22</b>	2	2	24
25	<b>11</b>	40	<b>22</b>	2	2	24
32	<b>15</b>	50	<b>22</b>	2	2	24
38	<b>18.5</b>	50	<b>22</b>	2	2	24

3RT2023-1FB44-3MA0
3RT2024-1FB44-3MA0
3RT2025-1FB44-3MA0
3RT2026-1FB44-3MA0
3RT2027-1FB44-3MA0
3RT2028-1FB44-3MA0

3RT2023-2FB44-3MA0
3RT2024-2FB44-3MA0
3RT2025-2FB44-3MA0
3RT2026-2FB44-3MA0
3RT2027-2FB44-3MA0
3RT2028-2FB44-3MA0

With voltage tap-off

9	<b>4</b>	40	<b>11</b>	1	1	24
12	<b>5.5</b>	40	<b>11</b>	1	1	24
17	<b>7.5</b>	40	<b>11</b>	1	1	24
25	<b>11</b>	40	<b>11</b>	1	1	24
32	<b>15</b>	50	<b>11</b>	1	1	24
38	<b>18.5</b>	50	<b>11</b>	1	1	24

3RT2023-1BB40-0CC0
3RT2024-1BB40-0CC0
3RT2025-1BB40-0CC0
3RT2026-1BB40-0CC0
3RT2027-1BB40-0CC0
3RT2028-1BB40-0CC0

3RT2023-2BB40-0CC0
3RT2024-2BB40-0CC0
3RT2025-2BB40-0CC0
3RT2026-2BB40-0CC0
3RT2027-2BB40-0CC0
3RT2028-2BB40-0CC0

Other voltages according to page 3/67 on request.

Accessories and spare parts, see pages 3/69 to 3/119.

## Switching devices – Contactors and contactor assemblies – for switching motors

### Power contactors for switching motors

SIRIUS 3RT contactors, 3-pole up to 250 kW **IE3/IE4 ready** **AC-3e**

#### DC operation for direct control by PLC

- Coupling contactors with adapted power consumption
- Suitable for solid-state PLC/F-PLC outputs
- Cannot be expanded with auxiliary switches





PU (UNIT, SET, M) = 1  
 PS\* = 1 unit  
 PG = 41B



3RT202.-1KB40



3RT202.-2KB40

Rated data		Auxiliary contacts		Rated control supply voltage $U_s$	Screw terminals 		Spring-loaded terminals 	
AC-3 and AC-3e, $t_u$ : 60 °C		AC-1, $t_u$ : 40 °C		DC	Article No.	Price per PU	Article No.	Price per PU
Operational current $I_e$ up to 400 V	Ratings of three-phase motors at 50 Hz and <b>400 V</b>	Operational current $I_e$ up to 690 V	Ident. No.	Version				
A	<b>kW</b>	A						
			NO	NC		V		

#### For screw fixing and snap-on mounting on TH 35 DIN rail

#### Size S0

#### With integrated coil circuit (varistor integrated in electronics at the factory)

(cannot be expanded with auxiliary switches)

Operating range **0.7 ... 1.25 x  $U_s$**

power consumption of the solenoid coils **4.5 W** at 24 V

9	4	40	11	1	1	24	3RT2023-1KB40	3RT2023-2KB40
12	5.5	40	11	1	1	24	3RT2024-1KB40	3RT2024-2KB40
17	7.5	40	11	1	1	24	3RT2025-1KB40	3RT2025-2KB40
25	11	40	11	1	1	24	3RT2026-1KB40	3RT2026-2KB40
32	15	50	11	1	1	24	3RT2027-1KB40	3RT2027-2KB40

Other voltages [according to page 3/67](#) on request.

Accessories and spare parts, [see pages 3/69 to 3/119](#).

# Switching devices – Contactors and contactor assemblies – for switching motors

## Power contactors for switching motors

AC-3e

IE3/IE4 ready

SIRIUS 3RT contactors, 3-pole up to 250 kW

### DC operation for direct control by PLC

- Coupling contactors with adapted power consumption
- Suitable for solid-state PLC/F-PLC outputs with 2 A
- Can be expanded using front or lateral auxiliary switch (1 x left and 1 x right)

PU (UNIT, SET, M) = 1  
 PS\* = 1 unit  
 PG = 41B



3RT203.-1KB40







3RT203.-3KB40



3RT204.-1KB40



3RT204.-3KB40

Rated data		Auxiliary contacts		Rated control supply voltage $U_s$		Screw terminals 		Spring-loaded terminals 	
AC-3 and AC-3e, $t_{ij}$ : 60 °C		AC-1, $t_{ij}$ : 40 °C		DC		Article No.		Article No.	
Operational current $I_e$ up to	Ratings of three-phase motors at 50 Hz and	Operational current $I_e$ up to	Ident. No.	Version			Price per PU		Price per PU
400 V	<b>400 V</b>	690 V							
A	<b>kW</b>	A		NO	NC	V			

### For screw fixing and snap-on mounting on TH 35 DIN rail

#### Size S2

#### With integrated coil circuit (varistor integrated in electronics at the factory)

Operating range **0.8 ... 1.2 x  $U_s$** ,  
 closing power of the solenoid coils **21.5 W** at 24 V

41	18.5	60	11	1	1	24	3RT2035-1KB40	3RT2035-3KB40
51	22	70	11	1	1	24	3RT2036-1KB40	3RT2036-3KB40
65	30	80	11	1	1	24	3RT2037-1KB40	3RT2037-3KB40
80	37	90	11	1	1	24	3RT2038-1KB40	3RT2038-3KB40

### For screw fixing and snap-on mounting on TH 35-15 and TH 75-15 DIN rails

#### Size S3

#### With integrated coil circuit (varistor integrated in electronics at the factory)

Operating range **0.8 ... 1.2 x  $U_s$** ,  
 closing power of the solenoid coils **25 W** at 24 V

80	37	125	11	1	1	24	3RT2045-1KB40	3RT2045-3KB40
95	45	130	11	1	1	24	3RT2046-1KB40	3RT2046-3KB40

Other voltages according to page 3/67 on request.

Accessories and spare parts, see pages 3/69 to 3/119.

## Switching devices – Contactors and contactor assemblies – for switching motors

### Power contactors for switching motors

SIRIUS 3RT contactors, 3-pole up to 250 kW **IE3/IE4 ready** **AC-3e**

#### AC/DC operation

- Extended operating range of the solenoid coil 0.7 to 1.3 x  $U_s$
- Power consumption reduced from closing to closed

PU (UNIT, SET, M) = 1  
 PS\* = 1 unit  
 PG = 41B





3RT202.-1N.30



3RT202.-2N.30

Rated data		Auxiliary contacts		Rated control supply voltage $U_s$
AC-3 and AC-3e, $t_{ij}$ : 60 °C		AC-1, $t_{ij}$ : 40 °C		50/60 Hz AC or DC
Operational current $I_e$ up to 400 V	Ratings of three-phase motors at 50 Hz and <b>400 V</b>	Operational current $I_e$ up to 690 V	Ident. No.	Version
A	<b>kW</b>	A		
			NO	NC
				V

Screw terminals 		Spring-loaded terminals 	
Article No.	Price per PU	Article No.	Price per PU

#### For screw fixing and snap-on mounting on TH 35 DIN rail

#### Size S0

#### With integrated coil circuit (varistor integrated in electronics at the factory)

12	<b>5.5</b>	40	<b>11</b>	1	1	21 ... 28 95 ... 130 200 ... 280	<b>3RT2024-1NB30</b> <b>3RT2024-1NF30</b> <b>3RT2024-1NP30</b>	<b>3RT2024-2NB30</b> <b>3RT2024-2NF30</b> <b>3RT2024-2NP30</b>
17	<b>7.5</b>	40	<b>11</b>	1	1	21 ... 28 95 ... 130 200 ... 280	<b>3RT2025-1NB30</b> <b>3RT2025-1NF30</b> <b>3RT2025-1NP30</b>	<b>3RT2025-2NB30</b> <b>3RT2025-2NF30</b> <b>3RT2025-2NP30</b>
25	<b>11</b>	40	<b>11</b>	1	1	21 ... 28 95 ... 130 200 ... 280	<b>3RT2026-1NB30</b> <b>3RT2026-1NF30</b> <b>3RT2026-1NP30</b>	<b>3RT2026-2NB30</b> <b>3RT2026-2NF30</b> <b>3RT2026-2NP30</b>
32	<b>15</b>	50	<b>11</b>	1	1	21 ... 28 95 ... 130 200 ... 280	<b>3RT2027-1NB30</b> <b>3RT2027-1NF30</b> <b>3RT2027-1NP30</b>	<b>3RT2027-2NB30</b> <b>3RT2027-2NF30</b> <b>3RT2027-2NP30</b>
38	<b>18.5</b>	50	<b>11</b>	1	1	21 ... 28 95 ... 130 200 ... 280	<b>3RT2028-1NB30</b> <b>3RT2028-1NF30</b> <b>3RT2028-1NP30</b>	<b>3RT2028-2NB30</b> <b>3RT2028-2NF30</b> <b>3RT2028-2NP30</b>

Other voltages [according to page 3/67](#) on request.

Accessories and spare parts, [see pages 3/69 to 3/119](#).

# Switching devices – Contactors and contactor assemblies – for switching motors

## Power contactors for switching motors

AC-3e

IE3/IE4 ready

SIRIUS 3RT contactors, 3-pole up to 250 kW

### AC/DC operation

- Extended operating range of the solenoid coil 0.8 to 1.1 x  $U_s$
- Power consumption reduced from closing to closed

PU (UNIT, SET, M) = 1  
 PS\* = 1 unit  
 PG = 41B



3RT203.-1N.30



3RT203.-3N.30





3RT203.-1N.34



3RT203.-1NB34-3MA0



3RT203.-3NB34-3MA0

Rated data		Auxiliary contacts		Rated control supply voltage $U_s$	Screw terminals 	Spring-loaded terminals 
AC-3 and AC-3e, $t_f$ : 60 °C	AC-1, $t_f$ : 40 °C	Operational current $I_e$ up to 400 V	Operational current $I_e$ up to 690 V	50/60 Hz AC or DC	Article No.	Article No.
Ratings of three-phase motors at 50 Hz and 400 V		Ident. No.	Version		Price per PU	Price per PU
A	A					

For screw fixing and snap-on mounting on TH 35 DIN rail

### Size S2

With integrated coil circuit (varistor integrated in electronics at the factory)

Article No.	Rated current $I_e$ [A]	Rated power $P_n$ [kW]	Rated voltage $U_n$ [V]	Rated current $I_e$ [A]	Rated power $P_n$ [kW]	Rated voltage $U_n$ [V]	Rated current $I_e$ [A]	Rated power $P_n$ [kW]	Rated voltage $U_n$ [V]	Rated current $I_e$ [A]	Rated power $P_n$ [kW]	Rated voltage $U_n$ [V]
41	18.5	60	11	1	1	20 ... 33 83 ... 155 175 ... 280	3RT2035-1NB30 3RT2035-1NF30 3RT2035-1NP30	3RT2035-3NB30 3RT2035-3NF30 3RT2035-3NP30				
51	22	70	11	1	1	20 ... 33 83 ... 155 175 ... 280	3RT2036-1NB30 3RT2036-1NF30 3RT2036-1NP30	3RT2036-3NB30 3RT2036-3NF30 3RT2036-3NP30				
65	30	80	11	1	1	20 ... 33 83 ... 155 175 ... 280	3RT2037-1NB30 3RT2037-1NF30 3RT2037-1NP30	3RT2037-3NB30 3RT2037-3NF30 3RT2037-3NP30				
80	37	90	11	1	1	20 ... 33 83 ... 155 175 ... 280	3RT2038-1NB30 3RT2038-1NF30 3RT2038-1NP30	3RT2038-3NB30 3RT2038-3NF30 3RT2038-3NP30				

With removable auxiliary switch and integrated coil circuit (varistor integrated in electronics at the factory)

Article No.	Rated current $I_e$ [A]	Rated power $P_n$ [kW]	Rated voltage $U_n$ [V]	Rated current $I_e$ [A]	Rated power $P_n$ [kW]	Rated voltage $U_n$ [V]	Rated current $I_e$ [A]	Rated power $P_n$ [kW]	Rated voltage $U_n$ [V]	Rated current $I_e$ [A]	Rated power $P_n$ [kW]	Rated voltage $U_n$ [V]
41	18.5	60	22	2	2	20 ... 33 83 ... 155 175 ... 280	3RT2035-1NB34 3RT2035-1NF34 3RT2035-1NP34	-- -- --				
51	22	70	22	2	2	20 ... 33 83 ... 155 175 ... 280	3RT2036-1NB34 3RT2036-1NF34 3RT2036-1NP34	-- -- --				
65	30	80	22	2	2	20 ... 33 83 ... 155 175 ... 280	3RT2037-1NB34 3RT2037-1NF34 3RT2037-1NP34	-- -- --				
80	37	90	22	2	2	20 ... 33 83 ... 155 175 ... 280	3RT2038-1NB34 3RT2038-1NF34 3RT2038-1NP34	-- -- --				

With permanently mounted auxiliary switch and integrated coil circuit (varistor integrated in electronics at the factory)

Article No.	Rated current $I_e$ [A]	Rated power $P_n$ [kW]	Rated voltage $U_n$ [V]	Rated current $I_e$ [A]	Rated power $P_n$ [kW]	Rated voltage $U_n$ [V]	Rated current $I_e$ [A]	Rated power $P_n$ [kW]	Rated voltage $U_n$ [V]	Rated current $I_e$ [A]	Rated power $P_n$ [kW]	Rated voltage $U_n$ [V]
41	18.5	60	22	2	2	20 ... 33	3RT2035-1NB34-3MA0	3RT2035-3NB34-3MA0				
51	22	70	22	2	2	20 ... 33	3RT2036-1NB34-3MA0	3RT2036-3NB34-3MA0				
65	30	80	22	2	2	20 ... 33	3RT2037-1NB34-3MA0	3RT2037-3NB34-3MA0				
80	37	90	22	2	2	20 ... 33	3RT2038-1NB34-3MA0	3RT2038-3NB34-3MA0				

With voltage tap-off and integrated coil circuit (varistor integrated in electronics at the factory)

Article No.	Rated current $I_e$ [A]	Rated power $P_n$ [kW]	Rated voltage $U_n$ [V]	Rated current $I_e$ [A]	Rated power $P_n$ [kW]	Rated voltage $U_n$ [V]	Rated current $I_e$ [A]	Rated power $P_n$ [kW]	Rated voltage $U_n$ [V]	Rated current $I_e$ [A]	Rated power $P_n$ [kW]	Rated voltage $U_n$ [V]
41	18.5	60	11	1	1	20 ... 33	3RT2035-1NB30-0CC0	3RT2035-3NB30-0CC0				
51	22	70	11	1	1	20 ... 33	3RT2036-1NB30-0CC0	3RT2036-3NB30-0CC0				
65	30	80	11	1	1	20 ... 33	3RT2037-1NB30-0CC0	3RT2037-3NB30-0CC0				
80	37	90	11	1	1	20 ... 33	3RT2038-1NB30-0CC0	3RT2038-3NB30-0CC0				

Other voltages according to page 3/67 on request.

Accessories and spare parts, see pages 3/69 to 3/119.



# Switching devices – Contactors and contactor assemblies – for switching motors

## Power contactors for switching motors

**SIRIUS 3RT contactors, 3-pole up to 250 kW** **IE3/IE4 ready** **AC-3e**
**AC/DC operation**

- Certified and fail-safe 24 V DC control input with max. 20 mA, e.g. for control via the fail-safe output module of a controller (F-PLC) or safety relay
- Achievable Safety Integrity Level (SIL) according to IEC 62061 and Performance Level (PL) according to ISO 13849-1 with corresponding fault diagnostics:
  - With one contactor: SIL 2/PL c
  - With two contactors in series: SIL 3/PL e
  - Fail-safe applications can be implemented using this contactor.
- Extended operating range of the solenoid coil  $0.8$  to  $1.1 \times U_s$
- Power consumption reduced from closing to closed

For more information, see

- [Safety technology, page 11/1 onwards](#)
- [Guide of use for contactors in safety applications](#)

 PU (UNIT, SET, M) = 1  
 PS\* = 1 unit  
 PG = 41B

3RT203.-1S.30



3RT203.-3S.30



3RT204.-1S.30



3RT204.-3S.30

**Rated data**
AC-3 and AC-3e,  
 $t_u$ : 60 °COperational current  $I_e$   
up to  
400 V

A

Ratings of  
three-phase  
motors at  
50 Hz and  
**400 V**

kW

AC-1,  
 $t_u$ : 40 °COperational current  $I_e$   
up to  
690 V

A

Auxiliary contacts Rated control supply voltage  $U_s$ 

Ident. No.

Version

50/60 Hz AC or DC

**Screw terminals**

Article No.

Price  
per PU
**Spring-loaded terminals**

Article No.

Price  
per PU
**For screw fixing and snap-on mounting on TH 35 DIN rail**
**Size S2**
**With integrated coil circuit (varistor integrated in electronics at the factory)**

Article No.	Rated current $I_e$ (A)	Rated power (kW)	Rated voltage (V)	Ident. No.	Version	Control voltage $U_s$ (V)	Terminal type
41	18.5		60	01	-- 1	21 ... 33 83 ... 150 175 ... 280	3RT2035-1SB30 3RT2035-1SF30 3RT2035-1SP30
51	22		70	01	-- 1	21 ... 33 83 ... 150 175 ... 280	3RT2036-1SB30 3RT2036-1SF30 3RT2036-1SP30
65	30		80	01	-- 1	21 ... 33 83 ... 150 175 ... 280	3RT2037-1SB30 3RT2037-1SF30 3RT2037-1SP30
80	37		90	01	-- 1	21 ... 33 83 ... 150 175 ... 280	3RT2038-1SB30 3RT2038-1SF30 3RT2038-1SP30

**For screw fixing and snap-on mounting on TH 35-15 and TH 75-15 DIN rails**
**Size S3**
**With integrated coil circuit (varistor integrated in electronics at the factory)**

Article No.	Rated current $I_e$ (A)	Rated power (kW)	Rated voltage (V)	Ident. No.	Version	Control voltage $U_s$ (V)	Terminal type
80	37		125	01	-- 1	21 ... 33 83 ... 150 175 ... 280	3RT2045-1SB30 3RT2045-1SF30 3RT2045-1SP30
95	45		130	01	-- 1	21 ... 33 83 ... 150 175 ... 280	3RT2046-1SB30 3RT2046-1SF30 3RT2046-1SP30
110	55		130	01	-- 1	21 ... 33 83 ... 150 175 ... 280	3RT2047-1SB30 3RT2047-1SF30 3RT2047-1SP30

Accessories and spare parts, see pages 3/69 to 3/119.



# Switching devices – Contactors and contactor assemblies – for switching motors

## Power contactors for switching motors

AC-3e

IE3/IE4 ready

SIRIUS 3RT contactors, 3-pole up to 250 kW

### AC/DC operation

- Extended operating range of the solenoid coil 0.8 to 1.1 x  $U_s$
- Power consumption reduced from closing to closed

PU (UNIT, SET, M) = 1  
 PS\* = 1 unit  
 PG = 41B



3RT204.-1N.30



3RT204.-3N.30





3RT204.-1N.34



3RT204.-1NB34-3MA0



3RT204.-3NB34-3MA0

Rated data		Auxiliary contacts		Rated control supply voltage $U_s$	Screw terminals 	Spring-loaded terminals 						
AC-3 and AC-3e, $t_{ij}$ : 60 °C	AC-1, $t_{ij}$ : 40 °C	Ident. No.	Version	50/60 Hz AC or DC	Article No.	Article No.						
Operational current $I_e$ up to 400 V	Operational current $I_e$ up to 690 V				Price per PU	Price per PU						
<table border="1"> <tr> <th>Operational current <math>I_e</math> up to</th> <th>Rated power</th> </tr> <tr> <td>400 V</td> <td>400 V</td> </tr> <tr> <td>A</td> <td>kW</td> </tr> </table>	Operational current $I_e$ up to	Rated power	400 V	400 V	A	kW						
Operational current $I_e$ up to	Rated power											
400 V	400 V											
A	kW											

For screw fixing and snap-on mounting on TH 35-15 and TH 75-15 DIN rails

### Size S3

With integrated coil circuit (varistor integrated in electronics at the factory)

80	95	110	125	11	1	1	20 ... 33 83 ... 155 175 ... 280	3RT2045-1NB30 3RT2045-1NF30 3RT2045-1NP30	3RT2045-3NB30 3RT2045-3NF30 3RT2045-3NP30
37	45	55	130	11	1	1	20 ... 33 83 ... 155 175 ... 280	3RT2046-1NB30 3RT2046-1NF30 3RT2046-1NP30	3RT2046-3NB30 3RT2046-3NF30 3RT2046-3NP30
			130	11	1	1	20 ... 33 83 ... 155 175 ... 280	3RT2047-1NB30 3RT2047-1NF30 3RT2047-1NP30	3RT2047-3NB30 3RT2047-3NF30 3RT2047-3NP30

With removable auxiliary switch and integrated coil circuit (varistor integrated in electronics at the factory)

80	95	110	125	22	2	2	20 ... 33 83 ... 155 175 ... 280	3RT2045-1NB34 3RT2045-1NF34 3RT2045-1NP34	-- -- --
37	45		130	22	2	2	20 ... 33 83 ... 155 175 ... 280	3RT2046-1NB34 3RT2046-1NF34 3RT2046-1NP34	-- -- --
		55	130	22	2	2	20 ... 33 83 ... 155 175 ... 280	3RT2047-1NB34 3RT2047-1NF34 3RT2047-1NP34	-- -- --

With permanently mounted auxiliary switch and integrated coil circuit (varistor integrated in electronics at the factory)

80	95	110	125	22	2	2	20 ... 33	3RT2045-1NB34-3MA0 3RT2046-1NB34-3MA0 3RT2047-1NB34-3MA0	3RT2045-3NB34-3MA0 3RT2046-3NB34-3MA0 3RT2047-3NB34-3MA0
37	45	55	130	22	2	2	20 ... 33		

With voltage tap-off and integrated coil circuit (varistor integrated in electronics at the factory)

80	95	110	125	11	1	1	20 ... 33	3RT2045-1NB30-OCC0 3RT2046-1NB30-OCC0 3RT2047-1NB30-OCC0	3RT2045-3NB30-OCC0 3RT2046-3NB30-OCC0 3RT2047-3NB30-OCC0
37	45	55	130	11	1	1	20 ... 33		

Other voltages according to page 3/67 on request.

Accessories and spare parts, see pages 3/69 to 3/119.

# Switching devices – Contactors and contactor assemblies – for switching motors

## Power contactors for switching motors

SIRIUS 3RT contactors, 3-pole up to 250 kW **IE3/IE4 ready** **AC-3e**

### AC/DC operation

- Standard operating mechanism 3RT10...-A
- For screw fixing
- Auxiliary and control conductors: Screw terminals or spring-loaded terminals
- Main conductors: Busbar connections; a connection kit with screws, spring washers and nuts is enclosed.

PU (UNIT, SET, M) = 1  
PS\* = 1 unit  
PG = 41B



3RT105-6A.36





3RT106-6A.36



3RT107-6A.36



3RT107-2A.36

Size	Rated data			AC-1, $t_{ij}$ : 40 °C	Operational current $I_{oe}$ up to	Auxiliary contacts, lateral	Rated control supply voltage $U_s$	Screw terminals 		Spring-loaded terminals 	
	AC-3 and AC-3e, $t_{ij}$ : 60 °C	Rating of three-phase motors at 50 Hz and up to						Version	50/60 Hz AC or DC	Article No.	Price per PU
	500 V	<b>400 V</b>	500 V 690 V	690 V							
	A	<b>kW</b>	kW kW	A		NO NC V					

### Standard operating mechanism for AC and DC operation (power consumption reduced from closing to closed)

#### With integrated coil circuit (varistor integrated at the factory)

	S6	S10				S12			Screw terminals		Spring-loaded terminals	
	115	<b>55</b>	75	110	160	2	2	110 ... 127 220 ... 240	<b>3RT1054-6AF36</b> <b>3RT1054-6AP36</b>	<b>3RT1054-2AF36</b> <b>3RT1054-2AP36</b>		
	150	<b>75</b>	90	132	185	2	2	110 ... 127 220 ... 240	<b>3RT1055-6AF36</b> <b>3RT1055-6AP36</b>	<b>3RT1055-2AF36</b> <b>3RT1055-2AP36</b>		
	185	<b>90</b>	132	160	215	2	2	110 ... 127 220 ... 240	<b>3RT1056-6AF36</b> <b>3RT1056-6AP36</b>	<b>3RT1056-2AF36</b> <b>3RT1056-2AP36</b>		
	225	<b>110</b>	160	On request	275	2	2	110 ... 127 220 ... 240	<b>3RT1064-6AF36</b> <b>3RT1064-6AP36</b>	<b>3RT1064-2AF36</b> <b>3RT1064-2AP36</b>		
	265	<b>132</b>	160	On request	330	2	2	110 ... 127 220 ... 240	<b>3RT1065-6AF36</b> <b>3RT1065-6AP36</b>	<b>3RT1065-2AF36</b> <b>3RT1065-2AP36</b>		
	300	<b>160</b>	200	On request	330	2	2	110 ... 127 220 ... 240	<b>3RT1066-6AF36</b> <b>3RT1066-6AP36</b>	<b>3RT1066-2AF36</b> <b>3RT1066-2AP36</b>		
	400	<b>200</b>	250	400	430	2	2	110 ... 127 220 ... 240	<b>3RT1075-6AF36</b> <b>3RT1075-6AP36</b>	<b>3RT1075-2AF36</b> <b>3RT1075-2AP36</b>		
	500	<b>250</b>	315	400	610	2	2	110 ... 127 220 ... 240	<b>3RT1076-6AF36</b> <b>3RT1076-6AP36</b>	<b>3RT1076-2AF36</b> <b>3RT1076-2AP36</b>		

Other voltages [according to page 3/68](#) on request.

Accessories and spare parts, [see pages 3/69 to 3/119](#).

# Switching devices – Contactors and contactor assemblies – for switching motors

## Power contactors for switching motors

**AC-3e** **IE3/IE4 ready** SIRIUS 3RT contactors, 3-pole up to 250 kW

### AC/DC operation

- Certified and fail-safe 24 V DC control input with max. 20 mA, e.g. for control via the fail-safe output module of a controller (F-PLC) or safety relay
- Achievable Safety Integrity Level (SIL) according to IEC 62061 and Performance Level (PL) according to ISO 13849-1 with corresponding fault diagnostics:
  - With one contactor: SIL 2/PL c
  - With two contactors in series: SIL 3/PL e
  - Fail-safe applications can be implemented using this contactor.
- Version with removable lateral auxiliary switches or permanently mounted auxiliary switches
- For screw fixing
- Auxiliary and control conductors: Screw terminals
- Main conductors: Busbar connections; a connection kit with screws, spring washers and nuts is enclosed.

For more information, see

- [Safety technology, page 11/1 onwards](#)
- [Guide of use for contactors in safety applications](#)





3RT105.-6S.36

3RT106.-6S.36

3RT107.-6S.36

3RT105.-6S.36-3PA0

3RT107.-6S.36-3PA0

Size	Rated data according to IEC 60947-4-1 AC-3 and AC-3e, $t_c$ : 60 °C Operational current $I_e$ up to	Auxiliary contacts, lateral Version	Rated control supply voltage $U_s$ 50/60 Hz AC or DC	Screw terminals 	PU (UNIT, SET, M)	PS*	PG
500 V	Rating of three-phase motors at 50 Hz and up to			Article No.	Price per PU		
A	<b>400 V</b> kW	  V					

### Solid-state operating mechanism

#### With two removable laterally mounted auxiliary switches

##### With integrated coil circuit (varistor integrated in electronics at the factory)

S6	115	55	2	2	96 ... 127 200 ... 277	3RT1054-6SF36 3RT1054-6SP36	1	1 unit	41B
	150	75	2	2	96 ... 127 200 ... 277	3RT1055-6SF36 3RT1055-6SP36	1	1 unit	41B
	185	90	2	2	96 ... 127 200 ... 277	3RT1056-6SF36 3RT1056-6SP36	1	1 unit	41B
S10	225	110	2	2	96 ... 127 200 ... 277	3RT1064-6SF36 3RT1064-6SP36	1	1 unit	41B
	265	132	2	2	96 ... 127 200 ... 277	3RT1065-6SF36 3RT1065-6SP36	1	1 unit	41B
	300	160	2	2	96 ... 127 200 ... 277	3RT1066-6SF36 3RT1066-6SP36	1	1 unit	41B
S12	400	200	2	2	96 ... 127 200 ... 277	3RT1075-6SF36 3RT1075-6SP36	1	1 unit	41B
	500	250	2	2	96 ... 127 200 ... 277	3RT1076-6SF36 3RT1076-6SP36	1	1 unit	41B

#### With two permanently laterally mounted auxiliary switches

##### With integrated coil circuit (varistor integrated in electronics at the factory)

S6	115	55	2	2	96 ... 127 200 ... 277	3RT1054-6SF36-3PA0 3RT1054-6SP36-3PA0	1	1 unit	41B
	150	75	2	2	96 ... 127 200 ... 277	3RT1055-6SF36-3PA0 3RT1055-6SP36-3PA0	1	1 unit	41B
	185	90	2	2	96 ... 127 200 ... 277	3RT1056-6SF36-3PA0 3RT1056-6SP36-3PA0	1	1 unit	41B
S10	225	110	2	2	96 ... 127 200 ... 277	3RT1064-6SF36-3PA0 3RT1064-6SP36-3PA0	1	1 unit	41B
	265	132	2	2	96 ... 127 200 ... 277	3RT1065-6SF36-3PA0 3RT1065-6SP36-3PA0	1	1 unit	41B
	300	160	2	2	96 ... 127 200 ... 277	3RT1066-6SF36-3PA0 3RT1066-6SP36-3PA0	1	1 unit	41B
S12	400	200	2	2	96 ... 127 200 ... 277	3RT1075-6SF36-3PA0 3RT1075-6SP36-3PA0	1	1 unit	41B
	500	250	2	2	96 ... 127 200 ... 277	3RT1076-6SF36-3PA0 3RT1076-6SP36-3PA0	1	1 unit	41B

Accessories and spare parts, see pages 3/69 to 3/119.

# Switching devices – Contactors and contactor assemblies – for switching motors

## Power contactors for switching motors

SIRIUS 3RT contactors, 3-pole up to 250 kW **IE3/IE4 ready** **AC-3e**

### AC/DC operation

- Solid-state operating mechanism
  - 3RT10...-N with 24 V DC control signal input
  - 3RT10...-P with 24 V DC control signal input and with remaining lifetime indicator (RLT)
- For screw fixing
- Auxiliary and control conductors: Screw terminals or spring-loaded terminals
- Main conductors: Busbar connections; a connection kit with screws, spring washers and nuts is enclosed.

PU (UNIT, SET, M) = 1  
 PS\* = 1 unit  
 PG = 41B





3RT105.-6N.36

3RT106.-2N.36

3RT107.-6N.36

3RT107.-6P.35

3RT107.-2N.36

Size	Rated data	AC-1, $t_{ij}$ : 40 °C	Auxiliary contacts, lateral	Rated control supply voltage $U_s$	Screw terminals 	Spring-loaded terminals 
	AC-3 and AC-3e, $t_{ij}$ : 60 °C	Operational current $I_e$ up to	Version	50/60 Hz AC or DC	Article No.	Article No.
	Operational current $I_e$ up to	Operational current $I_e$ up to	NO NC V		Price per PU	Price per PU
	500 V A	400 V kW				
	500 V kW	690 V kW				

### Solid-state operating mechanism

**With 24 V DC control signal input**  
 e.g. for control by PLC

With integrated coil circuit (varistor integrated in electronics at the factory)

S6	115	55	75	110	160	2	2	96 ... 127 200 ... 277	3RT1054-6NF36 3RT1054-6NP36	3RT1054-2NF36 3RT1054-2NP36
	150	75	90	132	185	2	2	96 ... 127 200 ... 277	3RT1055-6NF36 3RT1055-6NP36	3RT1055-2NF36 3RT1055-2NP36
	185	90	132	160	215	2	2	96 ... 127 200 ... 277	3RT1056-6NF36 3RT1056-6NP36	3RT1056-2NF36 3RT1056-2NP36
S10	225	110	160	On request	275	2	2	96 ... 127 200 ... 277	3RT1064-6NF36 3RT1064-6NP36	3RT1064-2NF36 3RT1064-2NP36
	265	132	160	On request	330	2	2	96 ... 127 200 ... 277	3RT1065-6NF36 3RT1065-6NP36	3RT1065-2NF36 3RT1065-2NP36
	300	160	200	On request	330	2	2	96 ... 127 200 ... 277	3RT1066-6NF36 3RT1066-6NP36	3RT1066-2NF36 3RT1066-2NP36
S12	400	200	250	400	430	2	2	96 ... 127 200 ... 277	3RT1075-6NF36 3RT1075-6NP36	3RT1075-2NF36 3RT1075-2NP36
	500	250	315	400	610	2	2	96 ... 127 200 ... 277	3RT1076-6NF36 3RT1076-6NP36	3RT1076-2NF36 3RT1076-2NP36

**With 24 V DC control signal input · With remaining lifetime indicator (RLT),**  
 e.g. for control by PLC

With integrated coil circuit (varistor integrated in electronics at the factory)

S6	115	55	75	110	160	1	1	96 ... 127 200 ... 277	3RT1054-6PF35 3RT1054-6PP35	---
	150	75	90	132	185	1	1	96 ... 127 200 ... 277	3RT1055-6PF35 3RT1055-6PP35	---
	185	90	132	160	215	1	1	96 ... 127 200 ... 277	3RT1056-6PF35 3RT1056-6PP35	---
S10	225	110	160	On request	275	1	1	96 ... 127 200 ... 277	3RT1064-6PF35 3RT1064-6PP35	---
	265	132	160	On request	330	1	1	96 ... 127 200 ... 277	3RT1065-6PF35 3RT1065-6PP35	---
	300	160	200	On request	330	1	1	96 ... 127 200 ... 277	3RT1066-6PF35 3RT1066-6PP35	---
S12	400	200	250	400	430	1	1	96 ... 127 200 ... 277	3RT1075-6PF35 3RT1075-6PP35	---
	500	250	315	400	610	1	1	96 ... 127 200 ... 277	3RT1076-6PF35 3RT1076-6PP35	---

Other voltages according to page 3/68 on request.

Accessories and spare parts, see pages 3/69 to 3/119.

# Switching devices – Contactors and contactor assemblies – for switching motors

## Power contactors for switching motors

SIRIUS 3RT contactors, 3-pole up to 250 kW

### Options

**Rated control supply voltages for 3RT20 contactors, possible on request (change of the 10th and 11th digits of the article number)**

Delivery time on request

Rated control supply voltage $U_s$	Contactor type Size	3RT201, 3RH2 S00	3RT202 S0	3RT203 S2	3RT204 S3
<b>Sizes S00 to S3</b>					
<b>AC operation<sup>1)</sup></b>					
<b>Solenoid coils for 50 Hz</b> (exception: Size S00: 50 and 60 Hz <sup>2)</sup> )					
24 V AC		B0	B0	B0	B0
42 V AC		D0	D0	D0	D0
48 V AC		H0	H0	H0	H0
110 V AC		F0	F0	F0	F0
230 V AC		P0	P0	P0	P0
240 V AC		U0	U0	U0	U0
400 V AC		V0	V0	V0	V0
<b>Solenoid coils for 50 and 60 Hz<sup>2)</sup></b>					
24 V AC		B0	C2	C2	C2
42 V AC		D0	D2	D2	D2
48 V AC		H0	H2	H2	H2
110 V AC		F0	G2	G2	G2
220 V AC		N2	N2	N2	N2
230 V AC		P0	L2	L2	L2
<b>Solenoid coils (for USA and Canada<sup>3)</sup>)</b>					
<b>50 Hz</b>					
<b>60 Hz</b>					
110 V AC	120 V AC	K6	K6	K6	K6
220 V AC	240 V AC	P6	P6	P6	P6
<b>Solenoid coils (for Japan)</b>					
<b>50/60 Hz<sup>4)</sup></b>					
<b>60 Hz<sup>5)</sup></b>					
100 V AC	110 V AC	G6	G6	G6	G6
200 V AC	220 V AC	N6	N6	N6	N6
400 V AC	440 V AC	R6	R6	R6	R6
<b>DC operation<sup>1)</sup></b>					
12 V DC		A4	A4	--	--
24 V DC		B4	B4	--	--
42 V DC		D4	D4	--	--
48 V DC		W4	W4	--	--
60 V DC		E4	E4	--	--
110 V DC		F4	F4	--	--
125 V DC		G4	G4	--	--
220 V DC		M4	M4	--	--
230 V DC		P4	P4	--	--

### Examples

<b>AC operation</b>	3RT2023-1AP00	Contactor with screw terminals; with solenoid coil for 50 Hz for rated control supply voltage 230 V AC.
	3RT2023-1AG20	Contactor with screw terminals; with solenoid coil for 50/60 Hz for rated control supply voltage 110 V AC.
<b>DC operation</b>	3RT2025-2BB40	Contactor with spring-loaded terminals; for rated control supply voltage 24 V DC.
	3RT2025-2BG40	Contactor with spring-loaded terminals; for rated control supply voltage 125 V DC.

<sup>1)</sup> For deviating coil voltages and operating ranges of sizes S00 and S0, a SITOP 24 V DC power supply with wide-range input can be used for the coil control, see page 15/1 and Catalog KT 10.1.

<sup>2)</sup> Coil operating range  
- at 50 Hz:  $0.8$  to  $1.1 \times U_s$ ,  
- at 60 Hz:  $0.85$  to  $1.1 \times U_s$ .

<sup>3)</sup> Coil operating range  
- Size S00:  
at 50 Hz:  $0.85$  to  $1.1 \times U_s$ ,  
at 60 Hz:  $0.8$  to  $1.1 \times U_s$ ,  
- Sizes S0 to S3: at 50 Hz and 60 Hz:  $0.8$  to  $1.1 \times U_s$ .

<sup>4)</sup> Coil operating range  
- Size S00:  
at 50/60 Hz:  $0.85$  to  $1.1 \times U_s$ ,  
- Size S0:  
at 50 Hz:  $0.8$  to  $1.1 \times U_s$ ,  
at 60 Hz:  $0.85$  to  $1.1 \times U_s$ .

<sup>5)</sup> Coil operating range at 60 Hz:  $0.8$  to  $1.1 \times U_s$ .

Rated control supply voltage $U_{s \min}$ to $U_{s \max}$ <sup>1)</sup>	Contactor type Size	3RT202.-N S0	Rated control supply voltage $U_{s \min}$ to $U_{s \max}$ <sup>1)</sup>	Contactor type Size	3RT203.-N S2	3RT204.-N S3
<b>Sizes S00 to S3</b>						
<b>AC/DC operation (50/60 Hz AC or DC)</b>						
21 ... 28 V AC/DC		B3	20 ... 33 V AC/DC		B3	B3
95 ... 130 V AC/DC		F3	48 ... 80 V AC/DC		E3	E3
200 ... 280 V AC/DC <sup>2)</sup>		P3	83 ... 155 V AC/DC		F3	F3
			175 ... 280 V AC/DC		P3	P3

<sup>1)</sup> Coil operating range  
- Size S0:  $0.7 \times U_{s \min}$  to  $1.3 \times U_{s \max}$ ,  
- Sizes S2 and S3:  $0.8 \times U_{s \min}$  to  $1.1 \times U_{s \max}$ .

<sup>2)</sup> The following applies to S0 and  $U_{s \max} = 280$  V: Upper limit =  $1.1 \times U_{s \max}$

## Switching devices – Contactors and contactor assemblies – for switching motors

### Power contactors for switching motors

#### SIRIUS 3RT contactors, 3-pole up to 250 kW

**Rated control supply voltages for 3RT10 contactors, possible on request (change of the 10th and 11th digits of the article number)**

Delivery time on request

Rated control supply voltage	<b>Contactor type</b> 3RT105.-A, 3RT106.-A, 3RT107.-A	Rated control supply voltage	<b>Contactor type</b> 3RT105.-N, 3RT106.-N, 3RT107.-N	3RT105.-P, 3RT105.-S, 3RT106.-P, 3RT106.-S, 3RT107.-P, 3RT107.-S
$U_{s \min}$ to $U_{s \max}$	<b>Sizes</b> S6 to S12	$U_{s \min}$ to $U_{s \max}$	<b>Sizes</b> S6 to S12	
<b>Sizes S6 to S12</b>				

**AC/DC operation (50/60 Hz AC or DC) and operating range  $0.8 \times U_{s \min}$  to  $1.1 \times U_{s \max}$**

#### Standard operating mechanism

23 ... 26 V AC/DC	B3
42 ... 48 V AC/DC	D3
110 ... 127 V AC/DC	F3
200 ... 220 V AC/DC	M3
220 ... 240 V AC/DC	P3
240 ... 277 V AC/DC	U3
380 ... 420 V AC/DC	V3
440 ... 480 V AC/DC	R3
500 ... 550 V AC/DC	S3
575 ... 600 V AC/DC	T3

#### Solid-state operating mechanism

21 ... 27.3 V AC/DC	B3	--
96 ... 127 V AC/DC	F3	F3
200 ... 277 V AC/DC	P3	P3



# Switching devices – Contactors and contactor assemblies – for switching motors

## Power contactors for switching motors

### Accessories for SIRIUS 3RT contactors and SIRIUS 3RH2 contactor relays > General data

#### Overview

Extensive accessories and spare parts are available for SIRIUS 3RT power contactors and SIRIUS 3RH2 contactor relays.

These components are easily fitted to the contactors without the use of any tools according to requirements.

Overview graphics with mountable accessories:

- 3RT2 contactors, see pages 3/8 to 3/11
- 3RT10, 3RT12 and 3RT14 contactors, see pages 3/12 to 3/16
- 3RH2 contactor relays, see page 5/5

#### More information

TIA Selection Tool Cloud (TST Cloud), see [www.siemens.com/tstcloud/?node=Contactor](http://www.siemens.com/tstcloud/?node=Contactor)

Version	For contactors 3RT2, sizes S00 to S3; 3RH2, size S00	3RT105 to 3RT107, 3RT126 and 3RT127, 3RT145 to 3RT147; sizes S6 to S12	Selection and ordering data  Page
<b>Accessories for 3RT contactors and 3RH2 contactor relays</b>			
<b>Auxiliary switches</b>			
<b>Instantaneous</b>	3RH29.1	3RH19.1	3/81 ... 3/94
<b>Delayed</b>			
• Pneumatic time-delay auxiliary switches	3RT2927-2P..1	--	3/95
• Solid-state time-delay auxiliary switches	3RA2813, 3RA2814, 3RA2815	3RT1926-2E/-2F/-2G	3/95, 3/96
<b>Surge suppressors</b>			
• Without LED	3RT29.6-1B/-1C/-1D/-1E	3RT1956-1C	3/97, 3/98
• With LED	3RT29.6-1J/-1L/-1M	--	3/98
<b>Modules for contactor control</b>			
<b>Coupling links for control by PLC</b>			
	3RH29.4-.GP11	--	3/99
<b>3RA28 function modules</b>			
• For direct on-line starting: ON delay or OFF-delay	3RA2811, 3RA2812, 3RA2831, 3RA2832	--	3/100
• For star-delta (wye-delta) starting	3RA2816	--	3/100
<b>3RA27 function modules for IO-Link or AS-Interface</b>			
• For direct-on-line, reversing or star-delta (wye-delta) starting	3RA271.-A/-B/-C	--	3/101, 3/102
<b>Mechanical latching blocks</b>			
	3RT2926-3A.31	--	3/103
<b>OFF-delay devices for contactors with AC/DC and DC operation</b>			
	3RT2916-2B.01	--	3/103
<b>Link modules</b>			
<b>Link modules from motor starter protector to contactor</b>			
	3RA.9.1	--	7/61
<b>Safety main current connectors for two contactors</b>			
	3RA29.6-1A	--	3/104
<b>Assembly kits</b>			
• For reversing contactor assemblies	3RA29.3-2AA.	3RA19.3-2A	3/104
• For contactor assemblies for star-delta (wye-delta) starting	3RA29.-2BB., 3RA29.3-2C	3RA1953-3G, 3RA19.3-2/-3.	3/105, 3/106
<b>Single wiring modules</b>			
	3RA.9.3-3.A.	3RA19.3-3.	3/107
<b>Star jumpers (links for paralleling), 3-pole</b>			
	3RT.9.6-4BA3.	3RT19.6-4BA31	3/107
<b>Mechanical interlock kits for two contactors</b>			
	3RA29.2-2H	--	3/108
<b>Mechanical interlocks for contactor assemblies</b>			
	3RA2934-2B	3RA1954-2.	3/108
<b>Mechanical connectors for contactor assemblies</b>			
	3RA29.2-2.	3RA1932-2D	3/108
<b>Connection modules/adapters</b>			
<b>Links for paralleling for main conducting paths</b>			
	3RT.9.6-4BB.1	--	3/109
<b>1-phase infeed terminals</b>			
	3RA2943-3L	--	3/110
<b>3-phase infeed terminals</b>			
• With increased clearance and creepage distances	3RA2913-3K, 3RV29.5-5A.	--	3/110
	3RV2935-5E	--	3/110
<b>3-phase busbars</b>			
	3RV1915-1AB	--	3/110
<b>Terminal blocks for connecting auxiliary conductors to main terminals</b>			
• Box terminal blocks	3RT2946-4G	3RT19.-4G	3/110
• Box terminal for auxiliary conductor connection, 1-pole	--	3TX7500-0A	3/110
• Auxiliary conductor terminals, 3-pole	3RT2946-4F	--	3/110
<b>Solder pin adapters for mounting contactors on printed circuit boards</b>			
	3RT1916-4KA.	--	3/111
<b>Coil connection modules for connections from top or from bottom</b>			
	3RT2926-4R.1.	--	3/111
<b>Connection module (adapter and plug) for contactors with screw terminals</b>			
• Adapters	3RT19.6-4RD01	--	3/111
• Motor feeder connector	3RT1900-4RE01	--	3/111

## Switching devices – Contactors and contactor assemblies – for switching motors

### Power contactors for switching motors

#### Accessories for SIRIUS 3RT contactors and SIRIUS 3RH2 contactor relays > General data

Version	For contactors		Selection and ordering data
	3RT2, sizes S00 to S3; 3RH2, size S00	3RT105 to 3RT107, 3RT126 and 3RT127, 3RT145 to 3RT147; sizes S6 to S12	Page
<b>Accessories for 3RT contactors and 3RH2 contactor relays (continued)</b>			
<b>Covers</b>			
Terminal covers	3RT1946-4EA1, 3RT29.6-4EA.	3RT1956-4EA., 3RT1966-4EA., 3TX65.6-3B	3/112
Sealable covers	3RT2916-4MA10	3RT1926-4MA10	3/112
<b>Miscellaneous accessories</b>			
<b>Base plates</b>			
• For reversing contactor assemblies	--	3RT19.2-2A	3/113
• For contactor assemblies for star-delta (wye-delta) starting	3RA29.2-2F	3RA19.2-2.	3/113
<b>Adapters for screw fixing</b>	3RT1926-4P	--	3/113
<b>Connection kit for one complete contactor</b>	--	3RT19...4PA00	3/113
<b>EMC suppression modules</b>	3RT2916-1P . .	--	3/113
<b>Additional load modules</b>	3RT2916-1GA00	--	3/114
<b>LED modules for displaying contactor operation</b>	3RT2926-1QT00	3RT1926-1QT00	3/114
<b>Control kit</b>	3RT29.6-4MC00	--	3/114
<b>Insulation stop for securely holding back the conductor insulation for conductors up to 1 mm<sup>2</sup></b>	3RT2916-4JA02	3RT1916-4JA02	3/115
<b>Tools for opening spring-loaded terminals</b>	3RA2908-1A	3RA2908-1A	3/115
<b>Blank labels</b>	3RT2900-1SB.0	3RT2900-1SB.0	3/115
<b>Spare parts for 3RT2 contactors</b>			
<b>Solenoid coils</b>	3RT29...5...1	--	3/116, 3/117
<b>Withdrawable coils</b>	--	3RT19...5....	3/118
<b>Contacts with fixing parts</b>	3RT29...-6.	3RT19...-6.	3/119
<b>Arc chutes</b>	--	3RT19...-7.	3/119



## Switching devices – Contactors and contactor assemblies – for switching motors

### Power contactors for switching motors

#### Accessories for SIRIUS 3RT contactors and SIRIUS 3RH2 contactor relays > General data

##### Auxiliary switches

The auxiliary switches can be designed as force-guided contacts in 3RH contactor relays or also as mirror contacts in the case of 3RT power contactors.

For more information on force-guided operation and mirror contacts, see [Manuals](#) → "More information", page 3/76, and in the [selection and ordering data](#), page 3/81 onwards.

##### **Solid-state time-delay auxiliary switches for mounting on 3RT2 contactors and 3RH2 contactor relays**

See pages 3/76 and 3/95

The 3RA28 solid-state time-delayed auxiliary switches which can be mounted on the contactor are designed for applications in the range from 24 to 240 V AC/DC (wide voltage range). Both the electrical and mechanical connection are made by simple snapping on and locking.

The time-delay auxiliary switch is supplied with power directly by two plug-in contacts through the coil terminals of the contactor, in parallel with A./A2.

A protection circuit (varistor) is integrated in each module.

A sealable cover is available to protect against careless adjustment of the set times.

##### Note:

Mounting more auxiliary switches on the contactor is not permitted.

##### Surge suppressors

- Without LED (also for spring-loaded terminals)  
Sizes S00 to S3, see [page 3/97](#)
- With LED (also for spring-loaded terminals)  
Sizes S00 to S3, see [page 3/98](#)

All 3RT2 contactors and 3RH2 contactor relays can be retrofitted with RC elements or varistors for damping switching overvoltages in the coil. Diodes or diode assemblies (combination of interference suppression diode and Zener diode for short break times) can also be used.

The surge suppressors are plugged onto the front of size S00 contactors. Space is provided for them next to a snap-on auxiliary switch.

Varistors, RC elements or diode assemblies can be plugged onto the front of size S0 to S3 contactors. Exception: For size S3, the RC element is inserted on the front into the recesses to the left of the connection block.

Coupling contactors are supplied either without overvoltage damping or with a suppressor diode, varistor or diode connected as standard, according to the version.

##### Note:

The break times of the contactor, the opening delay times of the NO contacts and the closing delay times of the NC contacts increase with damping.

For more detailed information about how damping affects the time response, see [Equipment Manual](#).

##### **Coupling links for control by PLC**

See pages 3/78 and 3/99

- Operation with 24 V DC
- Operating range 17 to 30 V
- Low power consumption of 0.5 W
- An LED indicates the switching state.

The 3RH2924-1GP11 coupling link has an integrated surge suppressor (varistor) for the contactor coil being switched and is mounted on the size S0 contactor coil via a coil connection module.

## Switching devices – Contactors and contactor assemblies – for switching motors

### Power contactors for switching motors

#### Accessories for SIRIUS 3RT contactors and SIRIUS 3RH2 contactor relays > General data

##### **3RA28 function modules for mounting on 3RT2 contactors and 3RH2 contactor relays**

See pages 3/79 and 3/100

Simply by being plugged in place, the SIRIUS function modules enable different functionalities required for the assembly of starters to be realized in the feeder. The function modules and wiring kits thus help to reduce the wiring work within the feeder practically to zero.

##### Protection of the device connections

The specifications for short-circuit protection (fuses, circuit breakers, or miniature circuit breakers) are available for the device connections of the main circuit and the auxiliary circuit.

In order to ensure a holistic view for the protection of the device connections, the manufacturer is obliged to provide all relevant information for short-circuit protection and overcurrent protection.

For more information, for example if device connections for the control supply voltage, the supply voltage, or digital inputs/digital outputs are not connected to self-limiting current sources or energy sources, see [Equipment Manual or the technical product data sheet](#).

##### SIRIUS function modules for direct-on-line starting

The electronic timing relays which can be mounted on the contactor are available in these versions:

- Sizes S00 and S0 for applications in the range from 24 to 240 V AC/DC (wide voltage range)
- Sizes S2 and S3 for applications in either the range from 24 to 90 V AC/DC or 90 to 240 V AC/DC

Both the electrical and mechanical connection are made by simple snapping on and locking.

A protection circuit (varistor) is integrated in each module.

The electronic timing relay with semiconductor output uses two contact legs to actuate the contactor underneath by means of a semiconductor after the set time  $t$  has elapsed.

The switching state feedback is performed by a mechanical switching state indicator (plunger). In addition, the auxiliary switches in the contactors are freely accessible and can be used for feedbacks to the control system or for signal lamps.

A sealable cover is available to protect against careless adjustment of the set times.

The snap-on function modules for direct-on-line starting are used above all for realizing timing functions independently of the control system.

With the OFF-delay variant of the timing relay it is possible for example for the fan motor for cooling a main drive to be switched off with a delay so that sufficient cooling after operation is guaranteed; the programmer of the control system does not need to worry about such technical details of the plant.

The ON-delay timing relays enable for example the time-delayed starting of several drives so that the summation starting current does not rise too high, which could result in voltage failure.

The use of snap-on function modules for direct-on-line starting results in the following advantages:

- Reduction of control current wiring
- Prevention of wiring errors
- Reduction of testing costs
- Implementation of timing functions independently of the control system
- Less space required in the control cabinet compared to a separate timing relay
- No additive protection circuit required (varistor integrated)

##### Assembly of reversing starters

We offer ready-made wiring kits for the assembly of reversing starters. Use of these wiring kits offers further advantages, see [page 3/148](#).

##### SIRIUS function modules for star-delta (wye-delta) starting

Both interlocking and timing functions are required for the assembly of star-delta (wye-delta) starters. With the function modules for star-delta (wye-delta) starting and the matching link modules for the main circuit, these starters can be assembled easily and with absolutely no errors.

The entire sequence in the control circuit is integrated in the snap-on modules. This covers:

- An adjustable star time  $t$  from 0.5 to 60 s
- A non-adjustable dead interval of 50 ms
- Electrical contacting of the contactors by means of coil pick-off (contact legs)
- Feedback of the switching state at the contactor using a mechanical switch position indicator (plunger)
- Electrical interlocking between the contactors

These modules do not require their own terminals and can therefore be used for contactors with both screw and spring-loaded terminals in all the sizes S00 to S3. To start the star-delta (wye-delta) starter, only the first of the three contactors (line contactor) is actuated, like in the case of a direct-on-line starter. All other functions then take place inside the individual modules.

This also offers advantages if the timing function was previously implemented in a controller, as it again results in a significant reduction in the number of PLC outputs, the programming work and the wiring outlay.

The kits for the main circuit include the mechanical interlock, the star jumper, the wiring modules at the top and at the bottom, and the required connectors or connecting clips.

A protection circuit (varistor) is integrated in the basic module.

The function modules for star-delta (wye-delta) starting are mostly used where current-limiting measures for starting a drive are required and a high level of availability is essential at the same time. This technology has been used with success for several decades and has the additional advantage of requiring relatively little know-how. Through the use of function modules, the assembly work with simple standard components is even easier and absolutely error-free.

The use of function modules for star-delta (wye-delta) starting results in the following advantages:

- Operation solely through the line contactor A1/A2 – no further control current wiring needed
- Prevention of wiring errors
- Reduction of testing costs
- Integrated electrical interlocking saves costs and prevents errors
- Less space needed in the control cabinet compared to using a separate timing relay
- Adjustable starting in star mode from 0.5 to 60 s
- Independent of the contactor's control supply voltage (24 to 240 V AC/DC)
- Varistor integrated – no additive protection circuit required
- Mechanically coded assembly enables easy configuration and reliable wiring
- Fewer versions – one module kit for screw and spring-loaded connection and for all the contactor sizes S00 to S3
- Mechanical interlocking (with wiring kit for the main circuit)

## Switching devices – Contactors and contactor assemblies – for switching motors

### Power contactors for switching motors

#### Accessories for SIRIUS 3RT contactors and SIRIUS 3RH2 contactor relays > General data

##### **SIRIUS 3RA27 function modules for IO-Link or AS-Interface for mounting on 3RT2 contactors**

See pages 3/80 and 3/101

The SIRIUS 3RA27 function modules enable the assembly of starters and contactor assemblies for direct-on-line, reversing and star-delta (wye-delta) starting without any additional, complicated wiring of the individual components. They include the key control functions, e.g. timing and interlocking, required for the particular feeder and can be connected to the control system via either IO-Link or AS-Interface.

The electrical and mechanical connection to the contactor is established by snapping on and locking the respective modules. An additive protection circuit for the individual contactors can be dispensed with completely because a varistor is integrated in the modules. Feedback from the contactor contacts is performed with Hall sensors which provide reliable feedback on the switching state even under extremely dusty conditions.

The starters are connected to the higher-level control system through IO-Link, with the possibility of connecting up to four starters as a group to one port of the IO-Link master, or

Optionally, the connection can be made via AS-Interface (specification V2.1 or higher, in A/B technology). As a result, up to 62 starters can be connected to one master and the address is entered in the normal manner with an addressing unit.

Through this type of connection to the control system, a maximum of wiring is saved. In the case of AS-Interface, the wiring amounts to the control supply voltage and the two individual wires for AS-Interface.

The following essential signals are thus transmitted:

- Availability of the feeder in response to an indirect inquiry from the motor starter protector/circuit breaker
- Starter control
- Feedback concerning the switching state of the starter

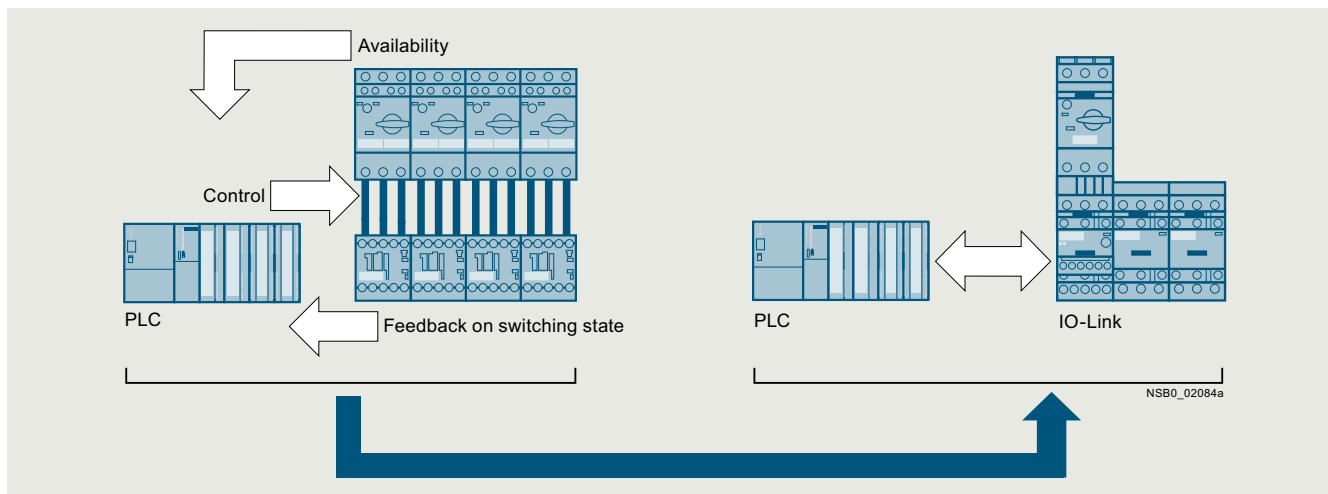

Signal transmission through IO-Link

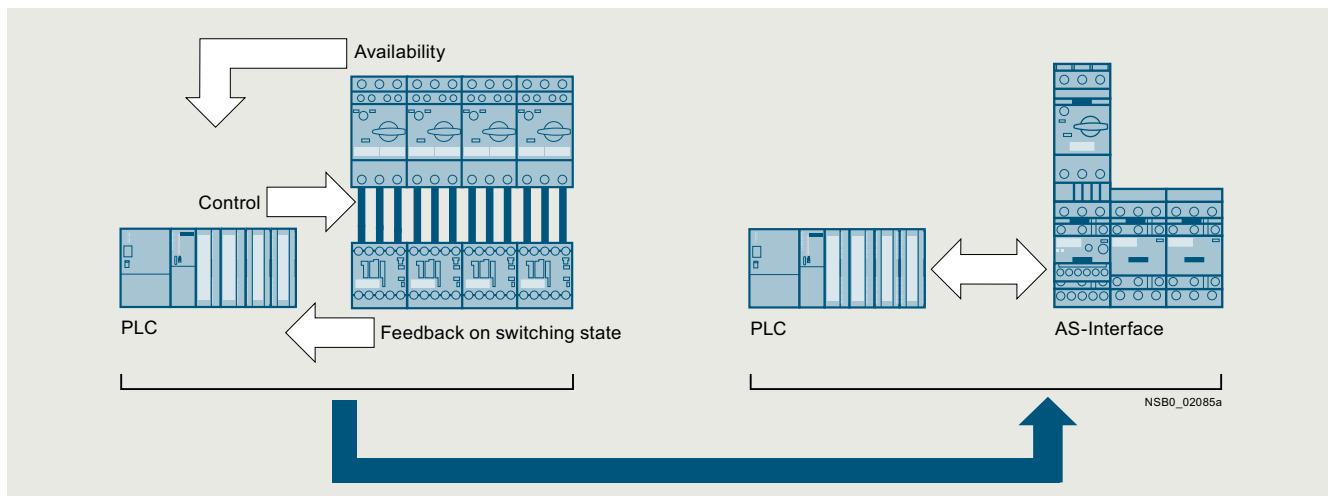

Signal transmission through AS-Interface

## Switching devices – Contactors and contactor assemblies – for switching motors

### Power contactors for switching motors

#### Accessories for SIRIUS 3RT contactors and SIRIUS 3RH2 contactor relays > General data

The inquiry from the motor starter protector/circuit breaker does not take place through additive wiring between the auxiliary switch and the module but by means of a voltage inquiry at the contactor input.

This requires special versions of the 3RT20...-.....-0CC0 contactors with voltage tap-off (see pages 3/53, 3/57, 3/61 and 3/63).

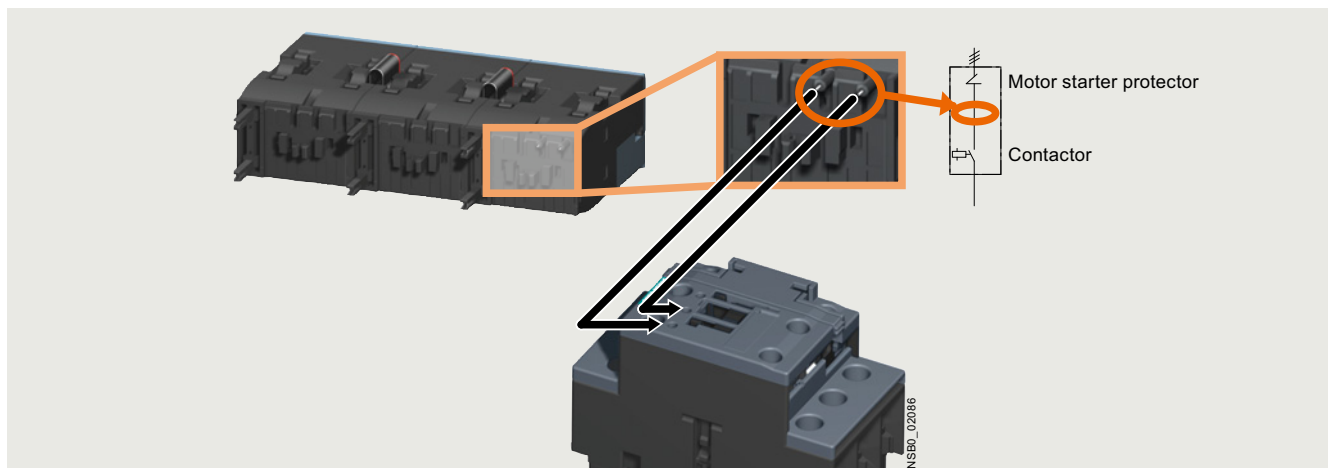

Availability signal through voltage tap-off

The following benefits result from the use of SIRIUS 3RA27 function modules:

- Reduction of control current wiring. In the case of IO-Link to no more than three cables for four feeders.
- Elimination of testing costs and wiring errors
- Reduction of configuration work
- Parameter server functionality
- Integration in TIA means unambiguous IO-Link diagnostics if a fault occurs
- Dispensing with IO modules saves space in the control cabinet
- All essential timing and interlocking functions for reversing duty and star-delta (wye-delta) starting are integrated
- No additive protection circuit required

For more information on IO-Link and AS-Interface, see "Industrial communication", page 2/1 onwards.

#### SIRIUS 3RA2711 function modules for IO-Link for mounting on 3RT2 contactors

By grouping up to four starters, it is possible to connect up to 16 starters to one master of the ET 200SP or S7-1200. In this case all the signals of the individual controls are made available directly in the process image of the input through only three individual wires per starter group. If the same potential is present

#### Protection of the device connections

The specifications for short-circuit protection (fuses, circuit breakers, or miniature circuit breakers) are available for the device connections of the main circuit and the auxiliary circuit.

In order to ensure a holistic view for the protection of the device connections, the manufacturer is obliged to provide all relevant information for short-circuit protection and overcurrent protection.

For more information, for example if device connections for the control supply voltage, the supply voltage, or digital inputs/digital outputs are not connected to self-limiting current sources or energy sources, see [Equipment Manual](#) or the [technical product data sheet](#).

at the ET 200SP or S7-1200 master and at the switching devices, the wiring can be further reduced by connecting the supply voltage of the contactor coils to the communication wires via jumpers.

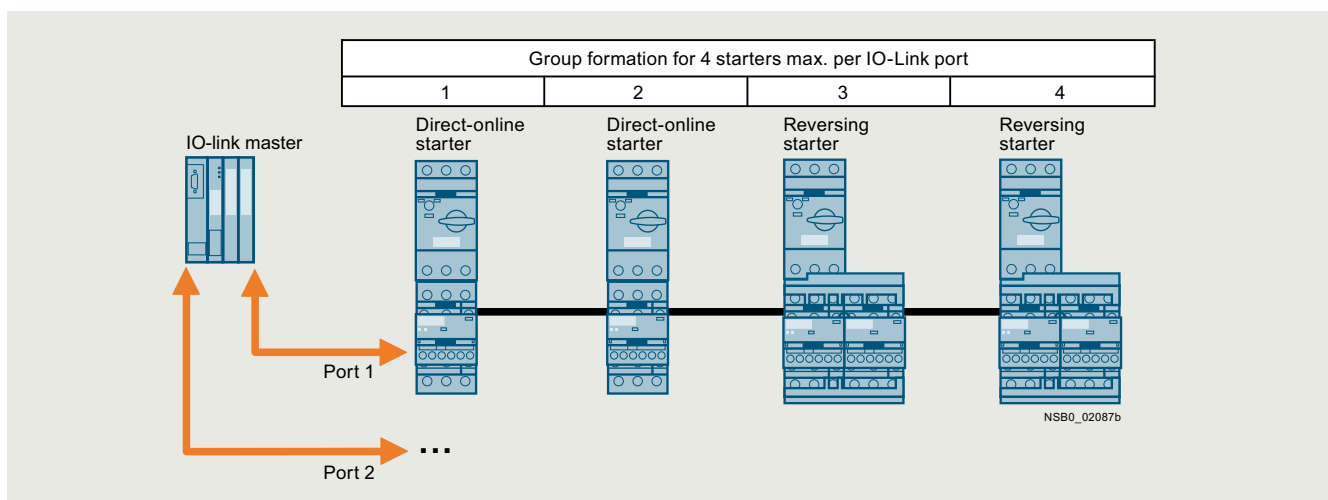

Group formation with IO-Link

## Switching devices – Contactors and contactor assemblies – for switching motors

### Power contactors for switching motors

#### Accessories for SIRIUS 3RT contactors and SIRIUS 3RH2 contactor relays > General data

In case of a malfunction, the corresponding error signals are also sent directly to the PLC in acyclic mode. This is in addition to transmission of the switching signals and status signals.

Possible error signals:

- Switching element defective
- No main voltage (motor starter protector tripped)
- No control supply voltage
- Limit position on the right/on the left
- Manual mode
- Process image fault

This easy integration of the starters in the TIA world does not limit the flexibility in the field in the least. For example, all function modules have special terminals in order to enable direct local disconnection. These terminals can be connected for example to a position switch. The input interrupts the voltage supply to the contactor coil directly, i.e. without going through the PLC. These terminals are jumpered in the delivery state.

Local manual operation of the complete starter group is also straightforward using a handheld device. The latter is easily connected to the last starter and can be built into the front panel of the control cabinet if required. This offers significant advantages particularly for commissioning.

SIRIUS function modules with IO-Link are used above all in machines and plants in which there are several motor feeders in one control cabinet. Using IO-Link, the connection of these feeders to the automation level is easy, quick and error-free. And with IO modules no longer needed, the width of the PLC is far smaller.

#### SIRIUS 3RA2712 function modules for AS-Interface for mounting on 3RT2 contactors

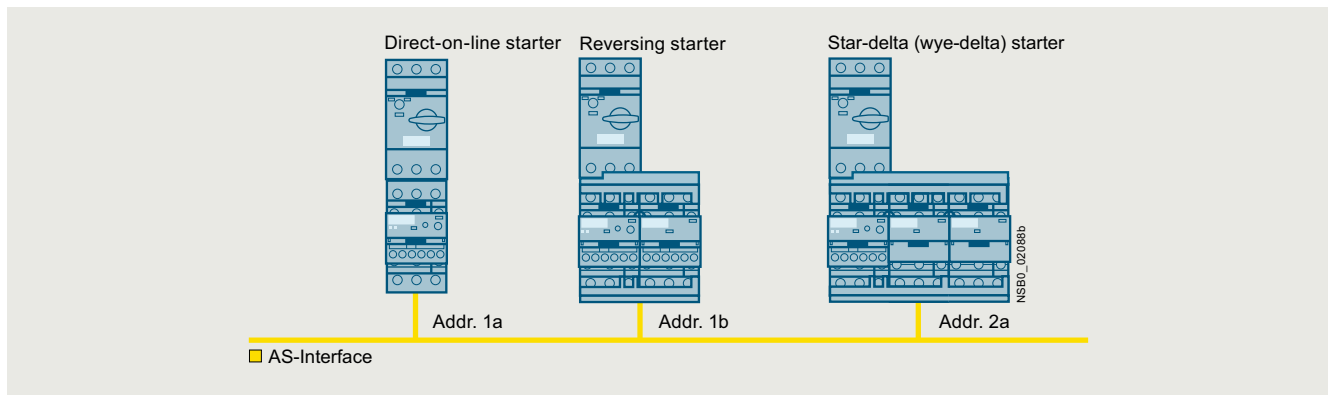

#### Topology with AS-Interface

This easy integration of the starters in the TIA world does not limit the flexibility in the field in the least. For example, all function modules have special terminals in order to enable direct local disconnection. These terminals can be connected for example to a position switch. The input interrupts the voltage supply to the contactor coil directly, i.e. without going through the PLC. These terminals are jumpered in the delivery state.

SIRIUS function modules with AS-Interface are recommended above all in machines and plants requiring easy connection of several different sensors and actuators both inside and outside the control cabinet to the higher-level control system. And with IO modules no longer needed, the width of the PLC is far smaller.

## Switching devices – Contactors and contactor assemblies – for switching motors

### Power contactors for switching motors

#### Accessories for SIRIUS 3RT contactors and SIRIUS 3RH2 contactor relays > General data

#### Technical specifications

##### More information

TIA Selection Tool Cloud (TST Cloud), see [www.siemens.com/tstcloud/?node=Contactor](http://www.siemens.com/tstcloud/?node=Contactor)

Technical specifications

- SIRIUS 3RT2 contactors and SIRIUS 3RH2 contactor relays, see <https://support.industry.siemens.com/cs/ww/en/ps/16208/td>
- SIRIUS 3RT1 contactors, see <https://support.industry.siemens.com/cs/ww/en/ps/16209/td>

FAQs

- SIRIUS 3RT2 contactors and SIRIUS 3RH2 contactor relays, see <https://support.industry.siemens.com/cs/ww/en/ps/16208/faq>
  - SIRIUS 3RT1 contactors, see <https://support.industry.siemens.com/cs/ww/en/ps/16209/faq>
- System Manual for modular system, see <https://support.industry.siemens.com/cs/ww/en/view/60311318>
- Equipment Manual, see <https://support.industry.siemens.com/cs/ww/en/view/60306557>



#### Solid-state time-delay auxiliary switches for mounting on 3RT201 to 3RT204 (sizes S00 to S3) and 3RH2 contactor relays (size S00)

Type		3RA2813	3RA2814	3RA2815
Function		ON-delay	OFF-delay with control signal	OFF-delay without control signal
<b>General data</b>				
<b>Dimensions</b> (basic unit with mounted solid-state time-delay auxiliary switch)				
<b>Rated insulation voltage <math>U_i</math></b> Pollution degree 3, overvoltage category III	V AC	See 3RT2 contactors (pages 3/29, 3/32, 3/35, 3/38) and 3RH2 contactor relays (page 5/8)		
<b>Rated impulse withstand voltage <math>U_{imp}</math></b>	kV AC	300		
<b>Permissible ambient temperature</b>				
• During operation	°C	-25 ... +60		
• During storage	°C	-40 ... +80		
<b>Electromagnetic compatibility (EMC)</b>				
IEC 61000-6-2, IEC 61000-6-4, IEC 61812-1, IEC 60947-4-1				
<b>Overvoltage protection</b>				
Varistor integrated				
<b>Control</b>				
<b>Operating range of excitation</b>				
0.85 ... 1.1 x $U_s$ , 0.95 ... 1.05 times the rated frequency				
<b>Rated power</b>				
	W	1		
• Power consumption at 230 V AC, 50 Hz	VA	2		
<b>Recovery time</b>				
	ms	150		
<b>Minimum ON duration</b>				
	ms	--	35	200
<b>Setting accuracy</b> , typ., with reference to upper limit of scale				
± 15%				
<b>Repeat accuracy</b> , max.				
± 1%				
<b>Load side</b>				
<b>Rated operational currents <math>I_e</math></b>				
• AC-15 at 24 ... 250 V, 50 Hz	A	3		
• DC-13				
- At 24 V	A	1		
- At 125 V	A	0.2		
- At 250 V	A	0.1		
<b>Mechanical endurance</b>				
	Operating cycles	10 x 10 <sup>6</sup>		
<b>Electrical endurance</b> at AC-15, 250 V, 3 A				
	Operating cycles	100 000		
<b>Residual current</b> , max.				
	mA	--		
<b>Voltage drop</b> , max., with conducting output				
	VA	--		
<b>Short-circuit protection</b>				
• Fuse links, operational class gG: DIAZED, type 5SB	A	4		

# Switching devices – Contactors and contactor assemblies – for switching motors

## Power contactors for switching motors

### Accessories for SIRIUS 3RT contactors and SIRIUS 3RH2 contactor relays > General data

Type		3RA2813 ON-delay	3RA2814 OFF-delay with control signal	3RA2815 OFF-delay without control signal
Function				
<b>Conductor cross-sections</b>				
<b>Connection type</b> (1 or 2 conductors can be connected)		 <b>Screw terminals</b>		
• Solid	mm <sup>2</sup>	1 x (0.5 ... 4), 2 x (0.5 ... 2.5)		
• Finely stranded with end sleeve (DIN 46228)	mm <sup>2</sup>	1 x (0.5 ... 2.5), 2 x (0.5 ... 1.5)		
• AWG cables, solid or stranded	AWG	2 x (20 ... 14)		
• Terminal screws		M3 (for standard screwdriver size 2 or Pozidriv 2)		
• Tightening torque	Nm	0.8 ... 1.2		
<b>Connection type</b> (1 or 2 conductors can be connected)		 <b>Spring-loaded terminals</b>		
• Solid	mm <sup>2</sup>	2 x (0.25 ... 1.5)		
• Finely stranded with end sleeve (DIN 46228)	mm <sup>2</sup>	2 x (0.25 ... 1.5)		
• Finely stranded without end sleeve	mm <sup>2</sup>	2 x (0.25 ... 1.5)		
• AWG cables, solid or stranded	AWG	2 x (24 ... 16)		
• Operating devices	mm	3.0 x 0.5		

#### Solid-state time-delay auxiliary switches, for snapping onto 3RT1 contactors

Type		3RT1926-2E, 3RT1926-2F, 3RT1926-2G
Sizes		S6 to S12
<b>General data</b>		
<b>Dimensions (W x H x D)</b>	mm	33 x 46 x 73
<b>Rated insulation voltage <math>U_i</math></b>	V AC	300
Pollution degree 3, overvoltage category III according to IEC 60664-1		
<b>Permissible ambient temperature</b>		
• During operation	°C	-25 ... +60
• During storage	°C	-40 ... +85
<b>Electromagnetic compatibility (EMC)</b>		IEC 61812-1
<b>Control</b>		
<b>Operating range of excitation</b>		0.85 ... 1.1 x $U_s$ , 0.95 ... 1.05 times the rated frequency
<b>Rated power</b>	W	2
Power consumption at 230 V AC, 50 Hz	VA	4
<b>Recovery time</b>	ms	150
<b>Minimum ON duration</b>	ms	200 (with OFF-delay)
<b>Setting accuracy, typ., with reference to upper limit of scale</b>	%	± 15
<b>Repeat accuracy, max.</b>	%	± 1

Type		3RT1926-2E, 3RT1926-2F, 3RT1926-2G
Sizes		S6 to S12
<b>Load side</b>		
<b>Rated operational currents <math>I_e</math></b>		
• AC-15, 230 V, 50 Hz	A	3
• DC-13, 24 V	A	1
• DC-13, 110 V	A	0.2
• DC-13, 230 V	A	0.1
<b>Short-circuit protection</b>		
Fuse links, operational class gG: DIAZED, type 5SB	A	4
<b>Mechanical endurance</b>	Operat- ing cycles	10 x 10 <sup>6</sup>
<b>Conductor cross-sections</b>		
<b>Connection type</b> (1 or 2 conductors can be connected)		 <b>Screw terminals</b>
• Solid	mm <sup>2</sup>	2 x (0.5 ... 1.5), 2 x (0.75 ... 4)
• Finely stranded with end sleeve	mm <sup>2</sup>	2 x (0.5 ... 2.5)
• AWG cables, solid or stranded	AWG	2 x (18 ... 14)
• Terminal screws		M3
• Tightening torque	Nm	0.8 ... 1.2





# Switching devices – Contactors and contactor assemblies – for switching motors

## Power contactors for switching motors

### Accessories for SIRIUS 3RT contactors and SIRIUS 3RH2 contactor relays > General data

#### Coupling links for control by PLC



Type		3RH2924-1GP11	3RH2914-.GP11
Mounting on contactors of size		S0	S00 to S3
<b>General data</b>			
<b>Standards</b>		IEC 60947	
<b>Rated insulation voltage <math>U_i</math></b> (pollution degree 3)	V	300	
<b>Protective separation</b> between coil and contacts According to IEC 60947-1, Annex N	V AC	Up to 300	
<b>Permissible ambient temperature</b>			
• During operation	°C	-25 ... +60	
• During storage	°C	-40 ... +80	
<b>Control side</b>			
<b>Rated control supply voltage <math>U_s</math></b>	V DC	24	
<b>Operating range</b>	V DC	17 ... 30	
<b>Power consumption at <math>U_s</math></b>	W	0.5	
<b>Nominal current input</b>	mA	20	
<b>Release voltage</b>	V	≥ 4	
<b>Function display</b>		Yellow LED	
<b>Protection circuit</b>		Varistors	
<b>Load side</b>			
<b>Mechanical endurance</b>	Operating cycles	20 million	10 million
<b>Electrical endurance at <math>I_e</math></b>	Operating cycles	0.1 million	
<b>Switching frequency</b>	1/h	5 000	
<b>Make-time</b>	ms	Approx. 7	
<b>Break-time</b>	ms	Approx. 4	
<b>Bounce time</b>	ms	Approx. 2	
<b>Contact material</b>		AgSnO <sub>2</sub>	
<b>Switching voltage</b>	V AC/DC	24 ... 250	
<b>Rated operational current <math>I_e</math></b>			
• AC-15/AC-14 at 230 V	A	3	
• DC-13 at 230 V	A	0.1	
<b>Permissible residual current</b> of the electronics (with 0 signal)	mA	2.5	
<b>Conductor cross-sections</b>			
<b>Connection type</b> (1 or 2 conductors can be connected)		 <b>Screw terminals</b>	
• Solid	mm <sup>2</sup>	2 x (0.5 ... 2.5)	
• Finely stranded with end sleeve (DIN 46228)	mm <sup>2</sup>	2 x (0.5 ... 1.5)	
• Terminal screws		M3	
<b>Connection type</b> (1 or 2 conductors can be connected)		 <b>Spring-loaded terminals</b>	
• Solid	mm <sup>2</sup>	--	2 x (0.25 ... 1.5)
• Finely stranded with end sleeve (DIN 46228)	mm <sup>2</sup>	--	2 x (0.25 ... 1.5)
• Finely stranded without end sleeve	mm <sup>2</sup>	--	2 x (0.25 ... 1.5)
• AWG cables, solid or stranded	AWG	--	2 x (24 ... 16)
• Operating devices	mm	--	3.0 x 0.5

# Switching devices – Contactors and contactor assemblies – for switching motors

## Power contactors for switching motors

### Accessories for SIRIUS 3RT contactors and SIRIUS 3RH2 contactor relays > General data

#### 3RA28 function modules for mounting on 3RT2 contactors and 3RH2 contactor relays



Type	3RA2811	3RA2831	3RA2812	3RA2832	3RA2816
Mounting on contactors of size	S00, S0	S2, S3	S00, S0	S2, S3	S00 to S3
Function	For direct-on-line starting			For star-delta (wye-delta) starting	
	ON-delay		OFF-delay with control signal		
<b>General data</b>					
<b>Dimensions</b> (basic unit with mounted function module)					
See 3RT2 contactors (pages 3/29, 3/32, 3/35, 3/38) and 3RH2 contactor relays (page 5/8)					
<b>Rated insulation voltage <math>U_i</math></b> Pollution degree 3, overvoltage category III	V AC	300			
<b>Rated impulse withstand voltage <math>U_{imp}</math></b>	kV AC	4			
<b>Overvoltage protection</b>	Varistor integrated				
<b>Recovery time</b>	ms	50			150
<b>Minimum ON duration</b>	ms	--	35	--	
<b>Setting accuracy, typ.</b> , with reference to upper limit of scale	± 15%				
<b>Repeat accuracy, max.</b>	± 1%				
<b>Permissible ambient temperature</b>					
• During operation	°C	-25 ... +60			
• During storage	°C	-40 ... +80			
<b>Electromagnetic compatibility (EMC)</b>	IEC 61000-6-2, IEC 61000-6-4, IEC 61812-1, IEC 60947-4-1				
<b>Control side</b>					
<b>Operating range of excitation</b>					
0.85 ... 1.1 x $U_s$ , 0.95 ... 1.05 times the rated frequency					
<b>Rated power</b>	W	1			
• Power consumption at 230 V AC, 50 Hz	VA	1			2
<b>Load side</b>					
<b>Mechanical endurance</b>	Operating cycles	100 x 10 <sup>6</sup>			10 x 10 <sup>6</sup>
<b>Electrical endurance</b>					
• With 3RT2028 contactor	Operating cycles	100 000			--
• At AC-15, 250 V, 3 A	Operating cycles	--			100 000
<b>Residual current, max.</b>	mA	5	--		
<b>Voltage drop, max.</b> , with conducting output	VA	3.5	--		
<b>Short-circuit protection</b>					
Version of the fuse link required for short-circuit protection of the auxiliary switch	A	--			Fuse gL/gG: 4
<b>Conductor cross-sections</b>					
<b>Connection type</b> (1 or 2 conductors can be connected)					
 <b>Screw terminals</b>					
• Solid	mm <sup>2</sup>	1 x (0.5 ... 4), 2 x (0.5 ... 2.5)			--
• Finely stranded with end sleeve (DIN 46228)	mm <sup>2</sup>	1 x (0.5 ... 2.5), 2 x (0.5 ... 1.5)			--
• AWG cables, solid or stranded	AWG	2 x (20 ... 14)			--
• Terminal screws		M3 (for standard screwdriver size 2 or Pozidriv 2)			--
• Tightening torque	Nm	0.8 ... 1.2			--
<b>Connection type</b> (1 or 2 conductors can be connected)					
 <b>Spring-loaded terminals</b>					
• Operating devices	mm	3.0 x 0.5			--
• Solid	mm <sup>2</sup>	2 x (0.25 ... 1.5)			--
• Finely stranded with end sleeve (DIN 46228)	mm <sup>2</sup>	2 x (0.25 ... 1.5)			--
• Finely stranded without end sleeve	mm <sup>2</sup>	2 x (0.25 ... 1.5)			--
• AWG cables, solid or stranded	AWG	2 x (24 ... 16)			--

# Switching devices – Contactors and contactor assemblies – for switching motors



## Power contactors for switching motors

### Accessories for SIRIUS 3RT contactors and SIRIUS 3RH2 contactor relays > General data

#### 3RA27 function modules for IO-Link for mounting on 3RT2 contactors

Type	<b>3RA2711</b>		
<b>General data</b>			
<b>Dimensions</b>	See 3RT2 contactors: pages 3/29, 3/32, 3/35 and 3/38		
<b>Suitable for IO-Link masters according to specification</b>	1.1		
<b>Permissible ambient temperature</b>			
• During operation	According to IEC 60947-1	°C	-25 ... +60
• During storage	According to IEC 60721-3-1	°C	-40 ... +80
• During transport	According to IEC 60721-3-2	°C	-40 ... +80
<b>Operational voltage <math>U_{Hi}</math></b>	V DC		24 ± 20%
<b>Max. length of the cables for the input Y1-Y2</b>	m		30
<b>Electromagnetic compatibility (EMC)</b>	IEC 61000-6-2, IEC 61000-6-4, IEC 60947-4-1		
<b>Conductor cross-sections</b>			
<b>Connection type</b> (1 or 2 conductors can be connected)	 <b>Screw terminals</b>		
• Solid	mm <sup>2</sup>		1 x (0.5 ... 4), 2 x (0.5 ... 2.5)
• Finely stranded with end sleeve (DIN 46228)	mm <sup>2</sup>		1 x (0.5 ... 2.5), 2 x (0.5 ... 1.5)
• AWG cables, solid or stranded	AWG		2 x (20 ... 14)
• Terminal screws			M3 (for standard screwdriver Ø 6 mm or Pozidriv 2)
• Tightening torque of the terminal screws	Nm		0.8 ... 1.2
<b>Connection type</b> (1 or 2 conductors can be connected)	 <b>Spring-loaded terminals</b>		
• Operating devices	mm		3.0 x 0.5
• Solid	mm <sup>2</sup>		2 x (0.25 ... 1.5)
• Finely stranded with end sleeve (DIN 46228)	mm <sup>2</sup>		2 x (0.25 ... 1.5)
• Finely stranded without end sleeve	mm <sup>2</sup>		2 x (0.25 ... 1.5)
• AWG cables, solid or stranded	AWG		2 x (24 ... 16)

#### 3RA27 function modules for AS-Interface for mounting on 3RT2 contactors

Type	<b>3RA2712</b>		
<b>General data</b>			
<b>Dimensions</b>	See 3RT2 contactors: pages 3/29, 3/32, 3/35 and 3/38		
<b>Slave type</b>	A/B slave		
<b>Suitable for AS-i masters according to specification</b>	2.1 or higher		
<b>AS-i slave profile IO.ID.ID2</b>	7.A.E		
<b>ID1 code (factory setting)</b>	7		
<b>Permissible ambient temperature</b>			
• During operation	According to IEC 60947-1	°C	-25 ... +60
• During storage	According to IEC 60721-3-1	°C	-40 ... +80
• During transport	According to IEC 60721-3-2	°C	-40 ... +80
<b>Operational voltage</b>			
• AS-Interface	V		26.5 ... 31.6
• AUX PWR 24 V DC	V		24 ± 20%
<b>Current consumption, max.</b>			
• AS-Interface	mA		30
• AUX PWR			
- Maximum pickup/hold current	Size S00	mA	200/200
	Size S0	mA	300/300
	Size S2	mA	1 300/50
	Size S3	mA	4 000/70
<b>Max. length of the cables for the input Y1-Y2</b>	m		30
<b>Electromagnetic compatibility (EMC)</b>	IEC 61000-6-2, IEC 61000-6-4, IEC 60947-4-1		
<b>Conductor cross-sections</b>			
<b>Connection type</b> (1 or 2 conductors can be connected)	 <b>Screw terminals</b>		
• Solid	mm <sup>2</sup>		1 x (0.5 ... 4), 2 x (0.5 ... 2.5)
• Finely stranded with end sleeve (DIN 46228)	mm <sup>2</sup>		1 x (0.5 ... 2.5), 2 x (0.5 ... 1.5)
• AWG cables, solid or stranded	AWG		2 x (20 ... 14)
• Terminal screws			M3 (for standard screwdriver Ø 6 mm or Pozidriv 2)
• Tightening torque of the terminal screws	Nm		0.8 ... 1.2
<b>Connection type</b> (1 or 2 conductors can be connected)	 <b>Spring-loaded terminals</b>		
• Operating devices	mm		3.0 x 0.5
• Solid	mm <sup>2</sup>		2 x (0.25 ... 1.5)
• Finely stranded with end sleeve (DIN 46228)	mm <sup>2</sup>		2 x (0.25 ... 1.5)
• Finely stranded without end sleeve	mm <sup>2</sup>		2 x (0.25 ... 1.5)
• AWG cables, solid or stranded	AWG		2 x (24 ... 16)

# Switching devices – Contactors and contactor assemblies – for switching motors

## Power contactors for switching motors

### Accessories for SIRIUS 3RT contactors and SIRIUS 3RH2 contactor relays > Auxiliary switches, instantaneous

#### Overview

#### Auxiliary switch: Terminal designations and identification numbers for auxiliary contacts

##### Terminal designations

The terminal designations are 2-digit, e.g. 13, 14, 21, 22:

- Tens digit: Sequence digit
  - Related terminals have the same sequence digit
- Units digit: Function digit
  - 1-2 for normally closed contacts (NC)
  - 3-4 for normally open contacts (NO)

##### Identification numbers

The identification number indicates the number and type of the auxiliary contacts, e.g. 40, 31, 22, 13:

- 1st digit: number of normally open contacts (NO)
- 2nd digit: number of normally closed contacts (NC)

Examples:









- 31 = 3 NO + 1 NC
- 40 = 4 NO





#### Selection aid for mountable auxiliary switches for power contactors and contactor relays

The auxiliary switches of the 3RH29 series for mounting on the front and side can be used for 3RT2 power contactors as well as for 3RH2 contactor relays.

The possible combinations of basic unit and mounted auxiliary switch can be found in the tables, [see the following pages](#).

Where the columns and lines intersect (blue and green in the example) you will find the identification number for the combination of basic unit (column) and auxiliary switch (line).

Additional auxiliary switch		3-pole contactors		
Article number	Auxiliary contacts	3RT201	3RT201	3RT202 to 3RT204
	Version	<b>S00</b>	<b>S00</b>	<b>S0 to S3</b>
	NO NC	<b>10</b>	<b>01</b>	<b>11</b>
				
				
		2. 3. 4. 5.	5. 6. 7. 8.	3. 4. 5. 6.
		According to EN 50012 <sup>1)</sup>		

Auxiliary switches without NO contact				
3RH2911-□HA01	-- 1 	<b>11</b>	02	<b>12</b>
3RH2911-□HA02	-- 2 	<b>12</b>	03	<b>13</b>
3RH2911-□HA03	-- 3 	<b>13</b>	04	<b>14</b>
3RH2911-□FA04	-- 4 	<b>14</b>	--	--
IC01_00716				
Auxiliary switch with 1 NO contact				
3RH2911-□HA10	1 -- 	20	11	<b>21</b>

- 1 For screw terminals
- 2 For spring-loaded terminals

<sup>1)</sup> Combinations according to EN 50012, EN 50011 and IEC 60947-5-1 are in bold print. All combinations comply with EN 50005.

#### Example 1

Basic unit: 3-pole 3RT2017 motor contactor with 1 NO  
 Required: 1 NO + 4 NC (Ident. No. 14)  
 Result: 3RH2911-.FA04 auxiliary switch

#### Example 2

Basic unit: 3-pole 3RT2023 motor contactor with 1 NO + 1 NC  
 Required: 1 NO + 4 NC (Ident. No. 14)  
 Result: 3RH2911-.HA03 auxiliary switch

	Example 1	Example 2
Type	3RT20 motor contactor, S00 with 1 NO	3RT20 motor contactor, S0 with 1 NO + 1 NC
Sequence digit	2. 3. 4. 5.	3. 4. 5. 6.
Type	Auxiliary switch with 4 NC, 3RH2911-.FA04	Auxiliary switch with 3 NC, 3RH2911-.HA03
Function digit	1. 1. 1. 1. 2. 2. 2. 2.	1. 1. 1. 2. 2. 2.
Combination	3RT20 motor contactor, S00 with aux. switch	3RT20 motor contactor, S0 with aux. switch
Terminal designation	13 21 31 41 51 14 22 32 42 52	13 21 31 41 51 14 22 32 42 52
Result	Ident. No. 14	Ident. No. 14

# Switching devices – Contactors and contactor assemblies – for switching motors

## Power contactors for switching motors

### Accessories for SIRIUS 3RT contactors and SIRIUS 3RH2 contactor relays > Auxiliary switches, instantaneous

Additional auxiliary switches		3-pole contactors			4-pole contactors				Contactor relays		
Article number	Auxiliary contacts Version	S00 3RT201	S0 to S3 3RT202, 3RT203, 3RT204, 3RT244	S00 3RT231	3RT251	S0 to S3 3RT232, 3RT233, 3RT234	3RT252, 3RT253, 3RT254	S00 3RH21, 3RH24			
	NO NC	10	01 11	--	--	11	11	40E	31E	22E	
		2, 3, 4, 5, 6	5, 6, 7, 8, 3, 4, 5, 6	1, 2, 3, 4	1, 2, 3, 4	3, 4, 5, 6	3, 4, 5, 6	5, 6, 7, 8	5, 6, 7, 8	5, 6, 7, 8	
		According to EN 50012 <sup>1)</sup>			According to EN 50012 <sup>1)</sup>				According to EN 50011 <sup>1)</sup>		

#### Auxiliary switches, front

##### Without NO contact

3RH2911-□HA01	--	1		11	02	12	01	01	12	12	41X	32X	23X
3RH2911-□HA02	--	2		12	03	13	02	02	13	--	42E	33X	24
3RH2911-□HA03	--	3		13	04	14	03	--	--	--	43	34	--
3RH2911-□FA04	--	4		14	--	--	--	--	--	--	44E	--	--

##### With 1 NO contact

3RH2911-□HA10	1	--		20	11	21	10	10	21	21	50E	41E	32E
3RH2911-□HA11	1	1		21	12	22	11	11	22	22	51X	42X	33X
3RH2911-□HA12	1	2		22	13	23	12	12	23	--	52	43	34
3RH2911-□HA13	1	3		23	14	24	13	--	--	--	53X	44X	--

##### With 2 NO contacts

3RH2911-□HA20	2	--		30	21	31	20	20	31	31	60E	51X	42X
3RH2911-□HA21	2	1		31	22	32	21	21	32	32	61	52	43
3RH2911-□HA22	2	2		32	23	33	22	22	33	--	62X	53	44X
3RH2911-□FA22	2	2		32	23	33	22	22	33	--	62X	53	44X

##### With 3 NO contacts

3RH2911-□HA30	3	--		40	31	41	30	30	41	41	70	61	52
3RH2911-□HA31	3	1		41	32	42	31	31	42	42	71X	62X	53X

##### With 4 NO contacts











3RH2911-□FA40	4	--		50	41	51	40	40	51	51	80E	71X	62X
---------------	---	----	--	----	----	----	----	----	----	----	-----	-----	-----

<sup>1)</sup> Combinations according to EN 50012, EN 50011 and IEC 60947-5-1 are in **bold** print. All combinations comply with EN 50005.

## Switching devices – Contactors and contactor assemblies – for switching motors



### Power contactors for switching motors

#### Accessories for SIRIUS 3RT contactors and SIRIUS 3RH2 contactor relays > Auxiliary switches, instantaneous









Additional auxiliary switches		3-pole contactors			4-pole contactors				Contactor relays			
Article number	Auxiliary contacts Version	S00 3RT201	S0 to S3 3RT202, 3RT203, 3RT204, 3RT244	S00 3RT231	S0 to S3 3RT251	S00 3RT232, 3RT233, 3RT234	S0 to S3 3RT252, 3RT253, 3RT254	S00 3RH21, 3RH24				
	NO NC	S00	S0 to S3	S00	S0 to S3	S00	S0 to S3	40E	31E	22E		
												
		2. 3. 4. 5.	5. 6. 7. 8.	3. 4. 5. 6.		1. 2. 3. 4.	1. 2. 3. 4.	3. 4. 5. 6.	3. 4. 5. 6.	5. 6. 7. 8.	5. 6. 7. 8.	5. 6. 7. 8.
		<b>According to EN 50005</b>			<b>According to EN 50005</b>				<b>According to EN 50005</b>			

#### Auxiliary switches, front (continued)

##### With make-before-break<sup>1)</sup>

<b>3RH2911-□FB11</b>	1 1		21	12	22	11	11	22	22	51	42	33
<b>3RH2911-□FB22</b>	2 2		32	23	33	22	22	33	--	62	53	44
<b>3RH2911-□FC22</b>	2 2		32	23	33	22	22	33	--	62	53	44

##### Complete inscription with terminals from top or bottom

<b>3RH2911-1AA10</b>	1 --		20	11	21	10	10	21	21	50	41	32
<b>3RH2911-1BA10</b>	1 --		20	11	21	10	10	21	21	50	41	32
<b>3RH2911-1AA01</b>	-- 1		11	02	12	01	01	12	12	41	32	23
<b>3RH2911-1BA01</b>	-- 1		11	02	12	01	01	12	12	41	32	23
<b>3RH2911-1LA11</b>	1 1		21	12	22	11	11	22	22	51	42	33
<b>3RH2911-1MA11</b>	1 1		21	12	22	11	11	22	22	51	42	33
<b>3RH2911-1LA20</b>	2 --		30	21	31	20	20	31	31	60	51	42
<b>3RH2911-1MA20</b>	2 --		30	21	31	20	20	31	31	60	51	42

<sup>1)</sup> Contacts with make-before-break have no mirror contact function.

# Switching devices – Contactors and contactor assemblies – for switching motors

## Power contactors for switching motors

### Accessories for SIRIUS 3RT contactors and SIRIUS 3RH2 contactor relays > Auxiliary switches, instantaneous

Additional auxiliary switches		3-pole contactors			4-pole contactors				Contactor relays		
Article number	Auxiliary contacts Version	S00 3RT201	S0 to S3 3RT202, 3RT203, 3RT204, 3RT244	S00 3RT231	3RT251	S0 to S3 3RT232, 3RT233, 3RT234	3RT252, 3RT253, 3RT254	S00 3RH21, 3RH24			
	NO NC	10	01	11	--	--	11	11	40E	31E	22E
		2. 3. 4. 5.	5. 6. 7. 8.	3. 4. 5. 6.			3. 4. 5. 6.	3. 4. 5. 6.	5. 6. 7. 8.	5. 6. 7. 8.	5. 6. 7. 8.
		According to EN 50005			According to EN 50005				According to EN 50011 <sup>1)</sup>		

#### Auxiliary switches, front (continued)

#### With complete inscription (for contactor relays<sup>2)</sup>)

3RH2911-□GA40	4	--		--	--	--	--	--	--	80E	--	--
3RH2911-□GA31	3	1		--	--	--	--	--	--	71E	--	--
3RH2911-□GA22	2	2		--	--	--	--	--	--	62E	--	--
3RH2911-□GA13	1	3		--	--	--	--	--	--	53E	--	--
3RH2911-□GA04	--	4		--	--	--	--	--	--	44E	--	--

#### Complete inscription

3RH2911-□XA40-0MA0	4	--		50	41	51	40	40	51	51	80E	71X	62X
3RH2911-□XA31-0MA0	3	1		41	32	42	31	31	42	42	71E	62X	53
3RH2911-□XA22-0MA0	2	2		32	23	33	22	22	33	--	62E	53	44X
3RH2911-□XA04-0MA0	--	4		14	--	--	--	--	--	--	44E	--	--

#### Solid-state compatible<sup>3)</sup>

3RH2911-2NE21	2 <sup>4)</sup>	1		31	22	32	21	21	32	32	61	52	43
3RH2911-1NE22	2 <sup>4)</sup>	2 <sup>4)</sup>		32	23	33	22	22	33	--	62	53	44
3RH2911-□NF02	--	2		12	03	13	02	02	13	--	42	33	24
3RH2911-□NF11	1	1		21	12	22	11	11	22	22	51	42	33
3RH2911-□NF20	2	--		30	21	31	20	20	31	31	60	51	42

<sup>1)</sup> Combinations according to EN 50011 and IEC 60947-5-1 are in **bold** print. All combinations comply with EN 50005.

<sup>2)</sup> For selection and ordering data, see page 3/89.

<sup>3)</sup> The internal circuit diagrams shown apply to sizes S00 to S3 (including mirror contacts). If size S00 is used for the contactor relays, the function of the mirror contact is not needed.









<sup>4)</sup> Of which one auxiliary contact is not solid-state compatible.



























# Switching devices – Contactors and contactor assemblies – for switching motors

## Power contactors for switching motors

### Accessories for SIRIUS 3RT contactors and SIRIUS 3RH2 contactor relays > Auxiliary switches, instantaneous

Additional auxiliary switches		3-pole contactors			4-pole contactors				Contactor relays				
Article number	Auxiliary contacts Version	S00	S0 to S3		S00		S0 to S3		S00				
	NO NC	<b>3RT201</b>	<b>3RT202, 3RT203, 3RT204, 3RT244</b>		<b>3RT231</b>	<b>3RT251</b>	<b>3RT232, 3RT233, 3RT234</b>	<b>3RT252, 3RT253, 3RT254</b>	<b>3RH21</b>				
		<b>10</b>	<b>01</b>	<b>11</b>	--	--	<b>11</b>	<b>11</b>	<b>40E</b>	<b>31E</b>	<b>22E</b>		
													
		2. 3. 4. 5.	5. 6. 7. 8.	3. 4. 5. 6.			1. 2. 3. 4.	1. 2. 3. 4.	3. 4. 5. 6.	3. 4. 5. 6.	5. 6. 7. 8.	5. 6. 7. 8.	5. 6. 7. 8.
		According to EN 50012 <sup>1)</sup>			According to EN 50012 <sup>1)</sup>				According to EN 50011 <sup>1)</sup>				

Lateral auxiliary switches														
For size S00		Left	Right											
<b>3RH2911-□DA02</b>	-- 2	--		<b>12</b>	--	--	02	02	--	--	--	--	--	--
<b>3RH2911-□DA02</b> + <b>3RH2911-□DA02</b>	-- 2			14	--	--	--	--	--	--	--	--	--	--
<b>3RH2911-□DA11</b>	1 1	--		<b>21</b>	--	--	11	11	--	--	--	--	--	--
<b>3RH2911-□DA11</b> + <b>3RH2911-□DA11</b>	1 1			32	--	--	22	22	--	--	--	--	--	--
<b>3RH2911-□DA20</b>	2 --	--		30	--	--	20	20	--	--	--	--	--	--
<b>3RH2911-□DA20</b> + <b>3RH2911-□DA20</b>	2 --			50	--	--	40	40	--	--	--	--	--	--
<b>3RH2911-□DA20</b> + <b>3RH2911-□DA11</b>	2 --			<b>41</b>	--	--	31	31	--	--	--	--	--	--
<b>3RH2911-□DA20</b> + <b>3RH2911-□DA02</b>	2 --			<b>32</b>	--	--	22	22	--	--	--	--	--	--
<b>3RH2911-□DA11</b> + <b>3RH2911-□DA02</b>	1 1			<b>23</b>	--	--	13	--	--	--	--	--	--	--
<b>For sizes S0 to S3</b>		Left	Right											
<b>3RH2921-□DA02</b>	-- 2	--		12	03	<b>13</b>	02	02	<b>13</b>	--	--	--	--	--
<b>3RH2921-□DA02</b> + <b>3RH2921-□DA02</b>	-- 2			14	--	--	--	--	--	--	--	--	--	--
<b>3RH2921-□DA11</b>	1 1	--		21	12	<b>22</b>	11	11	<b>22</b>	<b>22</b>	--	--	--	--
<b>3RH2921-□DA11</b> + <b>3RH2921-□DA11</b>	1 1			32	23	33	22	22	--	--	--	--	--	--
<b>3RH2921-□DA20</b>	2 --	--		30	21	<b>31</b>	20	20	<b>31</b>	<b>31</b>	--	--	--	--
<b>3RH2921-□DA20</b> + <b>3RH2921-□DA20</b>	2 --			50	41	51	40	40	--	--	--	--	--	--

<sup>1)</sup> Combinations according to EN 50012, EN 50011 and IEC 60947-5-1 are in **bold** print. All combinations comply with EN 50005.



# Switching devices – Contactors and contactor assemblies – for switching motors

## Power contactors for switching motors

### Accessories for SIRIUS 3RT contactors and SIRIUS 3RH2 contactor relays > Auxiliary switches, instantaneous

Additional auxiliary switches		3-pole contactors			4-pole contactors				Contactor relays		
Article number	Auxiliary contacts	S00	S0 to S3		S00	S0 to S3		S00			
Version		3RT201	3RT202, 3RT203, 3RT204, 3RT244		3RT231	3RT251	3RT232, 3RT233, 3RT234	3RT252, 3RT253, 3RT254	3RH21		
NO NC		10 01	11		-- --	11 11		40E 31E		22E	
		2. 3. 4. 5.	5. 6. 7. 8.	3. 4. 5. 6.	1. 2. 3. 4.	1. 2. 3. 4.	3. 4. 5. 6.	3. 4. 5. 6.	5. 6. 7. 8.	5. 6. 7. 8.	5. 6. 7. 8.
		According to EN 50012 <sup>1)</sup>			According to EN 50012 <sup>1)</sup>				According to EN 50011 <sup>1)</sup>		

#### Lateral auxiliary switches (continued)

For sizes S00 to S3		Left	Right									
3RH2921-□DA20 + 3RH2921-□DA11	2 --			41	32	42	31	31	--	--	--	--
3RH2921-□DA20 + 3RH2921-□DA02	2 --			32	23	33	22	22	--	--	--	--
3RH2921-□DA11 + 3RH2921-□DA02	1 1			23	14	24	13	--	--	--	--	--

#### For contactor relays<sup>2)</sup>

		Left									
3RH2921-□DA02	-- 2		--	--	--	--	--	--	<b>42Z</b>	<b>33X</b>	24
3RH2921-□DA11	1 1		--	--	--	--	--	--	<b>51X</b>	<b>42X</b>	<b>33X</b>
3RH2921-□DA20	2 --		--	--	--	--	--	--	<b>60Z</b>	<b>51X</b>	<b>42X</b>

#### Solid-state compatible

For size S00		Left	Right									
3RH2911-2DE11	1 1	--		21	--	--	11	11	--	--	--	--
3RH2911-2DE11 + 3RH2911-2DE11	1 1			32	--	--	22	22	--	--	--	--

For sizes S00 to S3		Left	Right									
3RH2921-□DE11	1 1	--		21	12	22	11	11	22	22	--	--
3RH2921-□DE11 + 3RH2921-□DE11	1 1			32	23	33	22	22	--	--	--	--

#### For contactor relays<sup>2)</sup>

		Left									
3RH2921-2DE11	1 1		--	--	--	--	--	--	<b>51X</b>	<b>42X</b>	<b>33X</b>

<sup>1)</sup> Combinations according to EN 50012, EN 50011 and IEC 60947-5-1 are in **bold** print. All combinations comply with EN 50005.

<sup>2)</sup> Without force-guided operation.

# Switching devices – Contactors and contactor assemblies – for switching motors

## Power contactors for switching motors

Accessories for SIRIUS 3RT contactors and SIRIUS 3RH2 contactor relays > Auxiliary switches, instantaneous

### Selection and ordering data

PU (UNIT, SET, M) = 1  
 PS\* = 1 unit  
 PG = 41B



3RH2911-1HA22



3RH2911-2HA22

For contactors/ contactor relays <sup>1)</sup>	Auxiliary contacts Version	Screw terminals		Spring-loaded terminals	
	Type	Article No.	Price per PU	Article No.	Price per PU
	 NO				
	 NC				

### Auxiliary switches for snapping onto the front

#### Sizes S00 to S3

3RT2.1, 3RT2.2, 3RT2.3, 3RT2.4, 3RH21, 3RH24	--	1	
	--	2	
	--	3	
	1	--	
	1	1	
	1	2	
	1	3	
	2	--	
	2	1	
	2	2	
	3	--	
	3	1	

<b>3RH2911-1HA01</b>	<b>3RH2911-2HA01</b>
<b>3RH2911-1HA02</b>	<b>3RH2911-2HA02</b>
<b>3RH2911-1HA03</b>	<b>3RH2911-2HA03</b>
<b>3RH2911-1HA10</b>	<b>3RH2911-2HA10</b>
<b>3RH2911-1HA11</b>	<b>3RH2911-2HA11</b>
<b>3RH2911-1HA12</b>	<b>3RH2911-2HA12</b>
<b>3RH2911-1HA13</b>	<b>3RH2911-2HA13</b>
<b>3RH2911-1HA20</b>	<b>3RH2911-2HA20</b>
<b>3RH2911-1HA21</b>	<b>3RH2911-2HA21</b>
<b>3RH2911-1HA22</b>	<b>3RH2911-2HA22</b>
<b>3RH2911-1HA30</b>	<b>3RH2911-2HA30</b>
<b>3RH2911-1HA31</b>	<b>3RH2911-2HA31</b>

<sup>1)</sup> For detailed information on use, see page 3/82.

# Switching devices – Contactors and contactor assemblies – for switching motors

## Power contactors for switching motors

### Accessories for SIRIUS 3RT contactors and SIRIUS 3RH2 contactor relays > Auxiliary switches, instantaneous

PU (UNIT, SET, M) = 1  
 PS\* = 1 unit  
 PG = 41B



3RH2911-1FC22



3RH2911-2FC22



3RH2911-1AA01



3RH2911-1BA01



3RH2911-1LA11



3RH2911-1MA11

For contactors/ contactor relays <sup>1)</sup>	Connections Position	Auxiliary contacts Version	Screw terminals		Spring-loaded terminals	
			Article No.	Price per PU	Article No.	Price per PU
Type		 NO NC NO NC				

#### Auxiliary switches for snapping onto the front

##### Sizes S00 to S3

3RT2.1, 3RT2.2, 3RT2.3, 3RT2.4, 3RH21, 3RH24	--	4	--	--	--		<b>3RH2911-1FA40</b>	<b>3RH2911-2FA40</b>
	--	2	2	--	--		<b>3RH2911-1FA22</b>	<b>3RH2911-2FA22</b>
	--	--	4	--	--		<b>3RH2911-1FA04</b>	<b>3RH2911-2FA04</b>
	--	--	--	1	1		<b>3RH2911-1FB11</b>	<b>3RH2911-2FB11</b>
	--	1	1	1	1		<b>3RH2911-1FB22</b>	<b>3RH2911-2FB22</b>
	--	--	--	2	2		<b>3RH2911-1FC22</b>	<b>3RH2911-2FC22</b>

#### 1-pole and 2-pole auxiliary switches, cable entry from top or bottom

3RT2.1, 3RT2.2, 3RT2.3, 3RT2.4, 3RH21, 3RH24	Top	1	--	--	--		<b>3RH2911-1AA10</b>	--
	Bottom	1	--	--	--		<b>3RH2911-1BA10</b>	--
	Top	--	1	--	--		<b>3RH2911-1AA01</b>	--
	Bottom	--	1	--	--		<b>3RH2911-1BA01</b>	--
	Top	1	1	--	--		<b>3RH2911-1LA11</b>	--
	Bottom	1	1	--	--		<b>3RH2911-1MA11</b>	--
	Top	2	--	--	--		<b>3RH2911-1LA20</b>	--
	Bottom	2	--	--	--		<b>3RH2911-1MA20</b>	--

<sup>1)</sup> For detailed information on use, see pages 3/82 and 3/83.

# Switching devices – Contactors and contactor assemblies – for switching motors

## Power contactors for switching motors

### Accessories for SIRIUS 3RT contactors and SIRIUS 3RH2 contactor relays > Auxiliary switches, instantaneous

PU (UNIT, SET, M) = 1  
 PS\* = 1 unit  
 PG = 41B



3RH2911-1GA22



3RH2911-2GA22

For contactor relays <sup>1)</sup>	Contactor relay with auxiliary switch	Auxiliary contacts
	Ident. No.	Version

Type



Screw terminals		Spring-loaded terminals	
Article No.	Price per PU	Article No.	Price per PU

#### Auxiliary switches for snapping onto the front

##### Size S00

##### Blocks for the assembly of contactor relays with 8 contacts

3RH2140, 3RH2440, Ident. No. 40E	<b>80E</b>	4	--	
	<b>71E</b>	3	1	
	<b>62E</b>	2	2	
	<b>53E</b>	1	3	
	<b>44E</b>	--	4	

<b>3RH2911-1GA40</b>	<b>3RH2911-2GA40</b>
<b>3RH2911-1GA31</b>	<b>3RH2911-2GA31</b>
<b>3RH2911-1GA22</b>	<b>3RH2911-2GA22</b>
<b>3RH2911-1GA13</b>	<b>3RH2911-2GA13</b>
<b>3RH2911-1GA04</b>	<b>3RH2911-2GA04</b>

<sup>1)</sup> For detailed information on use, see page 3/84.

PU (UNIT, SET, M) = 1  
 PS\* = 1 unit  
 PG = 41B



3RH2911-1XA22-0MA0



3RH2911-2XA22-0MA0

For contactors/ contactor relays <sup>1)</sup>	Auxiliary contacts	Version

Type

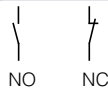

Screw terminals		Spring-loaded terminals	
Article No.	Price per PU	Article No.	Price per PU

#### Auxiliary switches for snapping onto the front

##### Sizes S00 to S3

3RT2.1, 3RT2.2, 3RT2.3, 3RT2.4, 3RH21 <sup>2)</sup> , 3RH24 <sup>2)</sup>	4	--	S00	S0 ... S3
	3	1		
	2	2		
	--	4		

<b>3RH2911-1XA40-0MA0</b>	<b>3RH2911-2XA40-0MA0</b>
<b>3RH2911-1XA31-0MA0</b>	<b>3RH2911-2XA31-0MA0</b>
<b>3RH2911-1XA22-0MA0</b>	<b>3RH2911-2XA22-0MA0</b>
<b>3RH2911-1XA04-0MA0</b>	<b>3RH2911-2XA04-0MA0</b>

<sup>1)</sup> For detailed information on use, see page 3/84.

<sup>2)</sup> For size S00, positively driven operation only applies for the 3RH contactor relay, and there is no positively driven operation for 3RT2 power contactors.

# Switching devices – Contactors and contactor assemblies – for switching motors

## Power contactors for switching motors

### Accessories for SIRIUS 3RT contactors and SIRIUS 3RH2 contactor relays > Auxiliary switches, instantaneous

PU (UNIT, SET, M) = 1  
 PS\* = 1 unit  
 PG = 41B



3RH1921-1XA22-0MA0

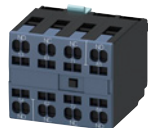

3RH1921-2XA22-0MA0



3RH1921-1CA10



3RH1921-1CD10



3RH1921-2CA10



3RH1921-2CA01

For contactors	Auxiliary contacts		Screw terminals		Spring-loaded terminals	
	Ident. No.	Version	Article No.	Price per PU	Article No.	Price per PU
Type						

#### Auxiliary switches for snapping onto the front

##### Sizes S6 to S12

##### 4-pole auxiliary switches

• According to EN 50012

3RT1.5 ... 3RT1.7	22	2	2	--	--	
						53  61  71  83  54  62  72  84

<b>3RH1921-1XA22-0MA0</b>
---------------------------

<b>3RH1921-2XA22-0MA0</b>
---------------------------

##### 1-pole auxiliary switches

• According to EN 50005 and EN 50012

3RT1.5 ... 3RT1.7	10	1	--	--	--	
						.3
	01	--	1	--	--	.4
						.1
	10	--	--	1	--	.2
				(lead- ing)		.7
						.8
	01	--	--	--	1	.5
					(lag- ging)	.6

<b>3RH1921-1CA10</b>
<b>3RH1921-1CA01</b>
<b>3RH1921-1CD10</b>
<b>3RH1921-1CD01</b>

<b>3RH1921-2CA10</b>
<b>3RH1921-2CA01</b>
--
--

# Switching devices – Contactors and contactor assemblies – for switching motors

## Power contactors for switching motors

### Accessories for SIRIUS 3RT contactors and SIRIUS 3RH2 contactor relays > Auxiliary switches, instantaneous

PU (UNIT, SET, M) = 1  
 PS\* = 1 unit  
 PG = 41B



3RH2911-1DA02



3RH2911-2DA02

For contactors/ contactor relays <sup>1)</sup>	Auxiliary contacts Version	Screw terminals		Spring-loaded terminals	
		Article No.	Price per PU	Article No.	Price per PU
Type	NO     NC				

**Laterally mountable auxiliary switches,  
mounting on the right and/or the left,  
2-pole**

**Size S00**

			Left	Right		
3RT2.1	--	2			<b>3RH2911-1DA02</b>	<b>3RH2911-2DA02</b>
	1	1			<b>3RH2911-1DA11</b>	<b>3RH2911-2DA11</b>
	2	--			<b>3RH2911-1DA20</b>	<b>3RH2911-2DA20</b>

3RH21, 3RH24	--	2		--	<b>3RH2921-1DA02</b>	<b>3RH2921-2DA02</b>
	1	1		--	<b>3RH2921-1DA11</b>	<b>3RH2921-2DA11</b>
	2	--		--	<b>3RH2921-1DA20</b>	<b>3RH2921-2DA20</b>

**Sizes S0 to S3**

3RT2.2 <sup>2)</sup> , 3RT2.3 <sup>3)</sup> , 3RT2.4 <sup>3)</sup>	--	2			<b>3RH2921-1DA02</b>	<b>3RH2921-2DA02</b>
	1	1			<b>3RH2921-1DA11</b>	<b>3RH2921-2DA11</b>
	2	--			<b>3RH2921-1DA20</b>	<b>3RH2921-2DA20</b>

<sup>1)</sup> For detailed information on use, see pages 3/85 and 3/86.

<sup>2)</sup> With 3RT232. and 3RT252. contactors, mountable only on the right.

<sup>3)</sup> 3RH2921-1DA.. lateral auxiliary switches can only be mounted on 3RT26 capacitor contactors of sizes S2 and S3.



# Switching devices – Contactors and contactor assemblies – for switching motors

## Power contactors for switching motors

### Accessories for SIRIUS 3RT contactors and SIRIUS 3RH2 contactor relays > Auxiliary switches, instantaneous

PU (UNIT, SET, M) = 1  
 PS\* = 1 unit  
 PG = 41B



3RH1921-1DA11



3RH1921-1JA11



3RH1921-1EA02



3RH1921-1KA02



3RH1921-2DA11

For contactors Auxiliary contacts  
 Version

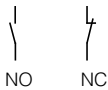

Type NO NC

**Screw terminals**



Article No.

Price per PU

**Spring-loaded terminals**



Article No.

Price per PU

#### Lateral auxiliary switches, mounting on the right or left, 2-pole

##### Sizes S6 to S12

Left Right

##### First auxiliary switch

• According to EN 50012

3RT1.5 ...  
3RT1.7

1 1

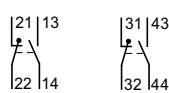

3RH1921-1DA11

3RH1921-2DA11

• According to EN 50005

3RT1.5 ...  
3RT1.7

2 --

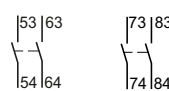

3RH1921-1EA20

3RH1921-2EA20

1 1

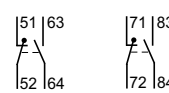

3RH1921-1EA11

--

-- 2

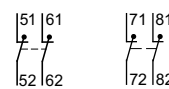

3RH1921-1EA02

3RH1921-2EA02

##### Second auxiliary switch

• According to EN 50012

3RT1.5 ...  
3RT1.7

1 1

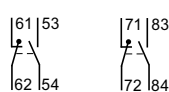

3RH1921-1JA11

3RH1921-2JA11

• According to EN 50005

3RT1.5 ...  
3RT1.7

2 --

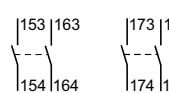

3RH1921-1KA20

3RH1921-2KA20

1 1

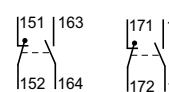

3RH1921-1KA11

--

-- 2

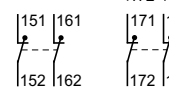

3RH1921-1KA02

3RH1921-2KA02

# Switching devices – Contactors and contactor assemblies – for switching motors

## Power contactors for switching motors

### Accessories for SIRIUS 3RT contactors and SIRIUS 3RH2 contactor relays > Auxiliary switches, instantaneous

PU (UNIT, SET, M) = 1  
 PS\* = 1 unit  
 PG = 41B



3RH2911-1NF.



3RH2911-2NF.

For contactors/ contactor relays <sup>1)</sup>	Size	Contacts Version	Screw terminals		Spring-loaded terminals	
			Article No.	Price per PU	Article No.	Price per PU
		  Type NO NC				

#### Auxiliary switches for snapping onto the front

##### Solid-state compatible auxiliary switches, 2-pole

- For operation in dusty atmospheres
- For solid-state circuits with rated operational currents  $I_{\theta}$ /AC-14 and DC-13 from 1 to 300 mA at 3 to 60 V
- Hard gold-plated contacts
- Auxiliary switches for snapping onto the front for 3RT2.2 to 3RT2.4 contactors are designed as mirror contacts according to IEC 60947-4-1, Annex F.

##### Sizes S00 to S3

			S00	S0 ... S3				
3RT2.1, 3RT2.2, 3RT2.3, 3RT2.4	S00 ... S3	2 <sup>2)</sup>	1	 .3   .3   .1 .4   .4   .2	 .3   .3   .1 .4   .4   .2	<b>NEW</b>	--	3RH2911-2NE21
		2 <sup>2)</sup>	2 <sup>2)</sup>	 .3   .3   .1   .1 .4   .4   .2   .2	 .3   .3   .1   .1 .4   .4   .2   .2	<b>NEW</b>	3RH2911-1NE22	--
	--	2	 .1   .1 .2   .2	 .1   .1 .2   .2		3RH2911-1NF02	3RH2911-2NF02	
	1	1	 .3   .1 .4   .2	 .3   .1 .4   .2		3RH2911-1NF11	3RH2911-2NF11	
	2	--	 .3   .3 .4   .4	 .3   .3 .4   .4		3RH2911-1NF20	3RH2911-2NF20	
3RH21, 3RH24	S00	2 <sup>2)</sup>	1	 .3   .3   .1 .4   .4   .2	--	<b>NEW</b>	--	3RH2911-2NE21
		2 <sup>2)</sup>	2 <sup>2)</sup>	 .3   .3   .1   .1 .4   .4   .2   .2	--	<b>NEW</b>	3RH2911-1NE22	--
	--	2	 .1   .1 .2   .2	--		3RH2911-1NF02	3RH2911-2NF02	
	1	1	 .3   .1 .4   .2	--		3RH2911-1NF11	3RH2911-2NF11	
	2	--	 .3   .3 .4   .4	--		3RH2911-1NF20	3RH2911-2NF20	

<sup>1)</sup> For detailed information on use, see page 3/84.

<sup>2)</sup> Of which one auxiliary contact is not solid-state compatible.

# Switching devices – Contactors and contactor assemblies – for switching motors

## Power contactors for switching motors

### Accessories for SIRIUS 3RT contactors and SIRIUS 3RH2 contactor relays > Auxiliary switches, instantaneous





PU (UNIT, SET, M) = 1  
 PS\* = 1 unit  
 PG = 41B



3RH2911-2DE11



3RH1921-2JE11

For contactors/ contactor relays <sup>1)</sup>	Size	Contacts Version		Screw terminals 		Spring-loaded terminals 	
				Article No.	Price per PU	Article No.	Price per PU
Type		NO	NC				

Lateral auxiliary switches, mounting on the right and/or the left, according to EN 50012

#### Solid-state compatible auxiliary switches, 2-pole

- For operation in dusty atmospheres
- For solid-state circuits with rated operational currents  $I_e$ /AC-14 and DC-13 from 1 to 300 mA at 3 to 60 V
- Hard gold-plated contacts
- Laterally mountable auxiliary switches for 3RT2.1 to 3RT2.4 and 3RT1.5 to 3RT1.7 contactors are designed as mirror contacts according to IEC 60947-4-1, Annex F.

#### Sizes S00 to S3

		Auxiliary switches		Left	Right		
3RT2.1	<b>S00</b>	1	1			--	<b>3RH2911-2DE11</b>
3RH21, 3RH24	<b>S00</b>	1	1		--	--	<b>3RH2921-2DE11</b>
3RT2.2, 3RT2.3, 3RT2.4	<b>S0 ... S3</b>	1	1			--	<b>3RH2921-2DE11</b>

#### Sizes S6 to S12

		First auxiliary switch		Left	Right		
3RT1.5 ... 3RT1.7	<b>S6 ... S12</b>	1	1			--	<b>3RH1921-2DE11</b>
3RT1.5 ... 3RT1.7	<b>S6 ... S12</b>	1	1			--	<b>3RH1921-2JE11</b>

<sup>1)</sup> Applies to 3RT2 and 3RH2 contactors: For detailed information on use, see page 3/86.

# Switching devices – Contactors and contactor assemblies – for switching motors

## Power contactors for switching motors

### Accessories for SIRIUS 3RT contactors and SIRIUS 3RH2 contactor relays > Auxiliary switches, delayed

#### Selection and ordering data

For contactors	Time setting range $t$	Screw terminals	⊕	PU (UNIT, SET, M)	PS*	PG
Type	s	Article No.		Price per PU		

#### Pneumatic time-delay auxiliary switches for mounting on 3RT2 contactors

##### Size S0

##### Auxiliary contacts 1 NO and 1 NC<sup>1)</sup>

##### ON-delay

3RT202 <sup>2)</sup>	1 ... 30	<b>3RT2927-2PA01</b>	1	1 unit	41B
	10 ... 180	<b>3RT2927-2PA11</b>	1	1 unit	41B

##### OFF-delay

3RT202 <sup>2)</sup>	1 ... 30	<b>3RT2927-2PR01</b>	1	1 unit	41B
	10 ... 180	<b>3RT2927-2PR11</b>	1	1 unit	41B



3RT2927-2P..1

- <sup>1)</sup> In addition to these, no other auxiliary contacts are permitted.  
<sup>2)</sup> Cannot be fitted onto coupling contactors and coupling contactor relays.

PU (UNIT, SET, M) = 1  
 PS\* = 1 unit  
 PG = 41B



3RA2813-1FW10



3RA2813-2AW10

For contactors	Rated control supply voltage $U_s$ <sup>1)</sup>	Time setting range $t$	Output/auxiliary contacts	Screw terminals	⊕	Spring-loaded terminals	⊕
Type	V	s		Article No.	Price per PU	Article No.	Price per PU

#### Solid-state time-delay auxiliary switches<sup>2)</sup> for mounting on 3RT2 contactors and 3RH2 contactor relays

##### Sizes S00 to S3

The electrical connection between the solid-state time-delay auxiliary switch and the contactor or contactor relay underneath is established automatically when it is snapped on and locked.

##### ON-delay

(varistor integrated)

3RT2 <sup>3)4)</sup> , 3RH21 <sup>3)</sup> , 3RH24	24 ... 240 AC/DC	0.05 ... 100 (1, 10, 100; selectable)	1 CO 1 NO + 1 NC	<b>3RA2813-1AW10</b> <b>3RA2813-1FW10</b>		<b>3RA2813-2AW10</b> <b>3RA2813-2FW10</b>	
--	------------------	---	---------------------	--	--	--	--

##### OFF-delay with control signal

(varistor integrated)

3RT2 <sup>3)4)</sup> , 3RH21 <sup>3)</sup> , 3RH24	24 ... 240 AC/DC	0.05 ... 100 (1, 10, 100; selectable)	1 CO 1 NO + 1 NC	<b>3RA2814-1AW10</b> <b>3RA2814-1FW10</b>		<b>3RA2814-2AW10</b> <b>3RA2814-2FW10</b>	
--	------------------	---	---------------------	--	--	--	--

##### OFF-delay without control signal<sup>5)</sup>

(varistor integrated)

3RT2 <sup>3)4)</sup> , 3RH21 <sup>3)</sup> , 3RH24	24 ... 240 AC/DC	0.05 ... 100 (1, 10, 100; selectable)	1 CO 1 NO + 1 NC	<b>3RA2815-1AW10</b> <b>3RA2815-1FW10</b>		<b>3RA2815-2AW10</b> <b>3RA2815-2FW10</b>	
--	------------------	---	---------------------	--	--	--	--



- <sup>1)</sup> AC voltage values apply for 50 Hz and 60 Hz.  
<sup>2)</sup> The solid-state time-delay auxiliary switches are also available as 3RA28 function modules for mounting on 3RT2 contactors and 3RH2 contactor relays, see page 3/100.  
<sup>3)</sup> Cannot be fitted onto coupling contactors and coupling contactor relays.  
<sup>4)</sup> From product version E04 onwards, 3RA281. solid-state time-delay auxiliary switches can be used for 3RT2.4 contactors.  
<sup>5)</sup> Setting of output contacts in as-supplied state not defined (bistable relay). Application of the control supply voltage once results in contact changeover to the correct setting.

Technical specifications, see page 3/76.

# Switching devices – Contactors and contactor assemblies – for switching motors

## Power contactors for switching motors

### Accessories for SIRIUS 3RT contactors and SIRIUS 3RH2 contactor relays > Auxiliary switches, delayed

For contactors	Auxiliary contacts	Rated control supply voltage $U_s$ <sup>1)</sup>	Time setting range $t$	Screw terminals	PU (UNIT, SET, M)	PS*	PG					
Type	V	s	Article No.	Price per PU								
<b>Solid-state time-delay auxiliary switches for mounting on 3RT1 contactors</b>												
<b>Sizes S6 to S12</b>												
<b>ON-delay<sup>2)</sup></b>												
 3RT1926-2E..1, 3RT1926-2F..1	3RT10, 3RT14	1 NO + 1 NC	24 AC/DC	0.05 ... 1	3RT1926-2EJ11	1	1 unit	41H				
				0.5 ... 10					3RT1926-2EJ21	1	1 unit	41H
				5 ... 100								
	100 ... 127 AC	0.05 ... 1	3RT1926-2EC11	1	1 unit	41H						
		0.5 ... 10					3RT1926-2EC21	1	1 unit	41H		
		5 ... 100					3RT1926-2EC31	1	1 unit	41H		
	200 ... 240 AC	0.05 ... 1	3RT1926-2ED11	1	1 unit	41H						
		0.5 ... 10					3RT1926-2ED21	1	1 unit	41H		
		5 ... 100					3RT1926-2ED31	1	1 unit	41H		
	<b>OFF-delay without control signal<sup>2)3)</sup></b>											
	 3RT1926-2G.51	3RT10, 3RT14	1 NO + 1 NC	24 AC/DC	0.05 ... 1	3RT1926-2FJ11	1	1 unit	41H			
					0.5 ... 10					3RT1926-2FJ21	1	1 unit
5 ... 100					3RT1926-2FJ31							
100 ... 127 AC/DC		0.05 ... 1	3RT1926-2FK11	1	1 unit	41H						
		0.5 ... 10					3RT1926-2FK21	1	1 unit	41H		
		5 ... 100					3RT1926-2FK31	1	1 unit	41H		
200 ... 240 AC/DC		0.05 ... 1	3RT1926-2FL11	1	1 unit	41H						
		0.5 ... 10					3RT1926-2FL21	1	1 unit	41H		
		5 ... 100					3RT1926-2FL31	1	1 unit	41H		
<b>Star-delta (wye-delta) starting (varistor integrated)<sup>2)</sup></b>												
3RT10, 3RT14		1 NO delayed + 1 NO instantaneous, dead time 50 ms	24 AC/DC	1.5 ... 30	3RT1926-2GJ51	1	1 unit	41H				
			100 ... 127 AC	1.5 ... 30	3RT1926-2GC51	1	1 unit	41H				
	200 ... 240 AC		1.5 ... 30	3RT1926-2GD51	1	1 unit	41H					

<sup>1)</sup> AC voltage values apply for 50 and 60 Hz.

<sup>2)</sup> Connecting terminals A1 and A2 for the control supply voltage of the solid-state time-delay auxiliary switch must be connected to the associated contactor by means of cables.

<sup>3)</sup> Setting of output contacts in as-supplied state not defined (bistable relay). Application of the control supply voltage once results in contact changeover to the correct setting.

# Switching devices – Contactors and contactor assemblies – for switching motors

## Power contactors for switching motors

Accessories for SIRIUS 3RT contactors and SIRIUS 3RH2 contactor relays > Surge suppressors

### Selection and ordering data

For contactors	Version	Rated control supply voltage $U_s^{1)}$		Article No.	Price per PU	PU (UNIT, SET, M)	PS*	PG
		AC operation	DC operation					
Type		V AC	V DC					

#### Surge suppressors without LED (also for spring-loaded terminals)

##### Size S00



3RT2916-1B.00

For plugging onto the front of the contactors (with or without auxiliary switches)

Type	Rated control supply voltage $U_s^{1)}$	Rated control supply voltage $U_s^{1)}$	Article No.	Price per PU	PU (UNIT, SET, M)	PS*	PG
3RT2.1, 3RH2	<b>Varistors</b>	24 ... 48	24 ... 70	<b>3RT2916-1BB00</b>	1	1 unit	41B
		48 ... 127	70 ... 150	<b>3RT2916-1BC00</b>	1	1 unit	41B
		127 ... 240	150 ... 250	<b>3RT2916-1BD00</b>	1	1 unit	41B
		240 ... 400	--	<b>3RT2916-1BE00</b>	1	1 unit	41B
		400 ... 600	--	<b>3RT2916-1BF00</b>	1	1 unit	41B
3RT2.1, 3RH2	<b>RC elements</b>	24 ... 48	24 ... 70	<b>3RT2916-1CB00</b>	1	1 unit	41B
		48 ... 127	70 ... 150	<b>3RT2916-1CC00</b>	1	1 unit	41B
		127 ... 240	150 ... 250	<b>3RT2916-1CD00</b>	1	1 unit	41B
		240 ... 400	--	<b>3RT2916-1CE00</b>	1	1 unit	41B
		400 ... 600	--	<b>3RT2916-1CF00</b>	1	1 unit	41B
3RT2.1, 3RH2	<b>Interference suppression diode</b>	--	12 ... 250	<b>3RT2916-1DG00</b>	1	1 unit	41B
3RT2.1, 3RH2	<b>Diode assemblies</b> (diode and Zener diode) for DC operation	--	12 ... 250	<b>3RT2916-1EH00</b>	1	1 unit	41B

##### Size S0



3RT2926-1E.00

For plugging into the front of the contactors (before mounting the auxiliary switch)

Type	Rated control supply voltage $U_s^{1)}$	Rated control supply voltage $U_s^{1)}$	Article No.	Price per PU	PU (UNIT, SET, M)	PS*	PG
3RT2.2	<b>Varistors<sup>2)</sup></b>	24 ... 48	24 ... 70	<b>3RT2926-1BB00</b>	1	1 unit	41B
		48 ... 127	70 ... 150	<b>3RT2926-1BC00</b>	1	1 unit	41B
		127 ... 240	150 ... 250	<b>3RT2926-1BD00</b>	1	1 unit	41B
		240 ... 400	--	<b>3RT2926-1BE00</b>	1	1 unit	41B
		400 ... 600	--	<b>3RT2926-1BF00</b>	1	1 unit	41B
3RT2.2	<b>RC elements</b>	24 ... 48	24 ... 70	<b>3RT2926-1CB00</b>	1	1 unit	41B
		48 ... 127	70 ... 150	<b>3RT2926-1CC00</b>	1	1 unit	41B
		127 ... 240	150 ... 250	<b>3RT2926-1CD00</b>	1	1 unit	41B
		240 ... 400	--	<b>3RT2926-1CE00</b>	1	1 unit	41B
		400 ... 600	--	<b>3RT2926-1CF00</b>	1	1 unit	41B
3RT2.2	<b>Diode assemblies</b> for DC operation	--	24	<b>3RT2926-1ER00</b>	1	1 unit	41B
		--	30 ... 250	<b>3RT2926-1ES00</b>	1	1 unit	41B

##### Size S2



3RT2936-1BF00

For plugging into the front of the contactors (before mounting the auxiliary switch)

Type	Rated control supply voltage $U_s^{1)}$	Rated control supply voltage $U_s^{1)}$	Article No.	Price per PU	PU (UNIT, SET, M)	PS*	PG
3RT2.3	<b>Varistors<sup>2)</sup></b>	24 ... 48	--	<b>3RT2936-1BB00</b>	1	1 unit	41B
		48 ... 127	--	<b>3RT2936-1BC00</b>	1	1 unit	41B
		127 ... 240	--	<b>3RT2936-1BD00</b>	1	1 unit	41B
		240 ... 400	--	<b>3RT2936-1BE00</b>	1	1 unit	41B
		400 ... 600	--	<b>3RT2936-1BF00</b>	1	1 unit	41B
3RT2.3	<b>RC elements</b>	24 ... 48	24 ... 70	<b>3RT2936-1CB00</b>	1	1 unit	41B
		48 ... 127	70 ... 150	<b>3RT2936-1CC00</b>	1	1 unit	41B
		127 ... 240	150 ... 250	<b>3RT2936-1CD00</b>	1	1 unit	41B
		240 ... 400	--	<b>3RT2936-1CE00</b>	1	1 unit	41B
		400 ... 600	--	<b>3RT2936-1CF00</b>	1	1 unit	41B
3RT2.3	<b>Diode assemblies</b> for DC operation	--	24	<b>3RT2936-1ER00</b>	1	1 unit	41B
		--	30 ... 250	<b>3RT2936-1ES00</b>	1	1 unit	41B

##### Size S3



3RT2936-1ER00

For plugging into the front of the contactors (before mounting the auxiliary switch)

Type	Rated control supply voltage $U_s^{1)}$	Rated control supply voltage $U_s^{1)}$	Article No.	Price per PU	PU (UNIT, SET, M)	PS*	PG
3RT2.4	<b>Varistors<sup>2)</sup></b>	24 ... 48	--	<b>3RT2936-1BB00</b>	1	1 unit	41B
		48 ... 127	--	<b>3RT2936-1BC00</b>	1	1 unit	41B
		127 ... 240	--	<b>3RT2936-1BD00</b>	1	1 unit	41B
		240 ... 400	--	<b>3RT2936-1BE00</b>	1	1 unit	41B
		400 ... 600	--	<b>3RT2936-1BF00</b>	1	1 unit	41B
3RT2.4	<b>Diode assemblies</b> for DC operation	--	24	<b>3RT2936-1ER00</b>	1	1 unit	41B
		--	30 ... 250	<b>3RT2936-1ES00</b>	1	1 unit	41B

For plugging into the two recesses on the left next to the connection block for auxiliary switches and coils A1 and A2, the connecting cables are wired to A1 and A2 (see also overview graphic on page 3/11)

Type	Rated control supply voltage $U_s^{1)}$	Rated control supply voltage $U_s^{1)}$	Article No.	Price per PU	PU (UNIT, SET, M)	PS*	PG
3RT2.4	<b>RC elements</b>	24 ... 48	24 ... 70	<b>3RT2946-1CB00</b>	1	1 unit	41B
		48 ... 127	70 ... 150	<b>3RT2946-1CC00</b>	1	1 unit	41B
		127 ... 240	150 ... 250	<b>3RT2946-1CD00</b>	1	1 unit	41B
		240 ... 400	--	<b>3RT2946-1CE00</b>	1	1 unit	41B
		400 ... 600	--	<b>3RT2946-1CF00</b>	1	1 unit	41B

3RT2946-1C.00

<sup>1)</sup> Can be used for AC operation for 50/60 Hz. Other voltages on request.

<sup>2)</sup> The varistor is already integrated on the AC/DC contactors.

# Switching devices – Contactors and contactor assemblies – for switching motors

## Power contactors for switching motors

### Accessories for SIRIUS 3RT contactors and SIRIUS 3RH2 contactor relays > Surge suppressors

For contactors	Version	Rated control supply voltage $U_s^{1)}$		Article No.	Price per PU	PU (UNIT, SET, M)	PS*	PG
		AC operation	DC operation					
Type		V AC	V DC					

#### Surge suppressors without LED

##### Sizes S6 to S12

For connecting to withdrawable coil for contactors with

- Standard operating mechanisms 3RT1...-A...
- Solid-state operating mechanisms 3RT1...-N...



3RT1956-1C.00

For contactors	Version	RC elements	24 ... 48	24 ... 70
3RT1.5 ...	3RT1.7		48 ... 127	70 ... 150
			127 ... 240	150 ... 250
			240 ... 400	--
			400 ... 600	--



##### Screw terminals



Article No.	Price per PU	PU (UNIT, SET, M)	PS*	PG
3RT1956-1CB00		1	1 unit	41B
3RT1956-1CC00		1	1 unit	41B
3RT1956-1CD00		1	1 unit	41B
3RT1956-1CE00		1	1 unit	41B
3RT1956-1CF00		1	1 unit	41B



3RT1956-1C.02

For contactors	Version	RC elements	24 ... 48	24 ... 70
3RT1.5 ...	3RT1.7		48 ... 127	70 ... 150
			127 ... 240	150 ... 250
			240 ... 400	--
			400 ... 600	--



##### Spring-loaded terminals



Article No.	Price per PU	PU (UNIT, SET, M)	PS*	PG
3RT1956-1CB02		1	1 unit	41B
3RT1956-1CC02		1	1 unit	41B
3RT1956-1CD02		1	1 unit	41B
3RT1956-1CE02		1	1 unit	41B
3RT1956-1CF02		1	1 unit	41B

<sup>1)</sup> Can be used for AC operation for 50/60 Hz. Other voltages on request.

For contactors	Version	Rated control supply voltage $U_s^{1)}$		Power consumption $P$ of LED at $U_s$	Article No.	Price per PU	PU (UNIT, SET, M)	PS*	PG
		AC operation	DC operation						
Type		V AC	V DC	mW					

#### Surge suppressors with LED (also for spring-loaded terminals)

##### Size S00

For plugging onto the front of the contactors (with or without auxiliary switches)



3RT2916-1J.00

For contactors	Version	Varistors	24 ... 48	12 ... 24	10 ... 120
3RT2.1, 3RH2			48 ... 127	24 ... 70	20 ... 470
			127 ... 240	70 ... 150	50 ... 700
			--	150 ... 250	160 ... 950
3RT2.1, 3RH2		Interference suppression diodes	--	24 ... 70	20 ... 470
			--	50 ... 150	50 ... 700
			--	150 ... 250	160 ... 950

Article No.	Price per PU	PU (UNIT, SET, M)	PS*	PG
3RT2916-1JJ00		1	1 unit	41B
3RT2916-1JK00		1	1 unit	41B
3RT2916-1JL00		1	1 unit	41B
3RT2916-1JP00		1	1 unit	41B
3RT2916-1LM00		1	1 unit	41B
3RT2916-1LN00		1	1 unit	41B
3RT2916-1LP00		1	1 unit	41B

##### Size S0

For plugging into the front of the contactors (before mounting the auxiliary switch)



3RT2926-1MR.00

For contactors	Version	Varistors	24 ... 48	12 ... 24	10 ... 120
3RT2.2			48 ... 127	24 ... 70	20 ... 470
			127 ... 240	70 ... 150	50 ... 700
3RT2.2		Diode assemblies	--	24	20 ... 470

Article No.	Price per PU	PU (UNIT, SET, M)	PS*	PG
3RT2926-1JJ00		1	1 unit	41B
3RT2926-1JK00		1	1 unit	41B
3RT2926-1JL00		1	1 unit	41B
3RT2926-1MR00		1	1 unit	41B

##### Sizes S2 and S3

For plugging into the front of the contactors (before mounting the auxiliary switch)



3RT2936-1JJ.00

For contactors	Version	Varistors	24 ... 48	12 ... 24	10 ... 120
3RT2.3, 3RT2.4			48 ... 127	24 ... 70	20 ... 470
			127 ... 240	70 ... 150	50 ... 700

Article No.	Price per PU	PU (UNIT, SET, M)	PS*	PG
3RT2936-1JJ00		1	1 unit	41B
3RT2936-1JK00		1	1 unit	41B
3RT2936-1JL00		1	1 unit	41B

<sup>1)</sup> Can be used for AC operation for 50/60 Hz. Other voltages on request.



# Switching devices – Contactors and contactor assemblies – for switching motors

## Power contactors for switching motors

Accessories for SIRIUS 3RT contactors and SIRIUS 3RH2 contactor relays > Modules for contactor control

### Selection and ordering data

For contactors	Version	Article No.	Price per PU	PU (UNIT, SET, M)	PS*	PG
Type						

#### Coupling links for control by PLC

#### Screw terminals

#### Size S0



3RH2924-1GP11

#### For mounting on the coil terminals of the contactors (for contactors with screw terminals only)

With LED for the switching state and with integrated varistor for damping switching overvoltages

- 24 V DC control, 17 ... 30 V DC operating range

3RH2924-1GP11

1 1 unit 41B

#### Sizes S00 to S3



3RH2914-1GP11

#### For mounting on the front of contactors with AC, DC or AC/DC operation

- 24 V DC control, 17 ... 30 V DC operating range

3RH2914-1GP11

1 1 unit 41B



3RH2914-2GP11

- 24 V DC control, 17 ... 30 V DC operating range

#### Spring-loaded terminals

3RH2914-2GP11

1 1 unit 41B

Technical specifications, [see page 3/78](#).

## Switching devices – Contactors and contactor assemblies – for switching motors

### Power contactors for switching motors

#### Accessories for SIRIUS 3RT contactors and SIRIUS 3RH2 contactor relays > Modules for contactor control

PU (UNIT, SET, M) = 1  
 PS\* = 1 unit  
 PG = 41B

#### More information

Equipment Manual for 3RA28 function modules, see  
<https://support.industry.siemens.com/cs/ww/en/view/60279150>



3RA2811-2CW10



3RA2812-1DW10



3RA2816-0EW20

For contactors	Size	Version	Rated control supply voltage $U_s$ <sup>1)</sup>	Time setting range $t$	Screw terminals	Spring-loaded terminals
Type			V AC/DC	s	Article No.	Price per PU

#### 3RA28 function modules for mounting on 3RT2 contactors and 3RH2 contactor relays

##### For direct-on-line starting

3RT2.1 <sup>2)</sup> , 3RT2.2 <sup>2)</sup> , 3RH21 <sup>2)</sup> , 3RH24	S00, S0	<b>ON-delay two-wire design, varistor integrated</b> The electrical connection between the function module and the contactor underneath is established automatically when it is snapped on and locked.	24 ... 240	0.05 ... 100 (1, 10, 100; selectable)	<b>3RA2811-1CW10</b>	<b>3RA2811-2CW10</b>
3RT2.3 <sup>2)</sup> , 3RT2.4 <sup>2)3)</sup>	S2, S3		24 ... 90 90 ... 240	0.05 ... 100 (1, 10, 100; selectable)	<b>3RA2831-1DG10</b> <b>3RA2831-1DH10</b>	<b>3RA2831-2DG10</b> <b>3RA2831-2DH10</b>
3RT2.1 <sup>2)</sup> , 3RT2.2 <sup>2)</sup> , 3RH21 <sup>2)</sup> , 3RH24	S00, S0	<b>OFF-delay with control signal, varistor integrated</b> The electrical connection between the function module and the contactor underneath is established automatically when it is snapped on and locked.	24 ... 240	0.05 ... 100 (1, 10, 100; selectable)	<b>3RA2812-1DW10</b>	<b>3RA2812-2DW10</b>
3RT2.3 <sup>2)</sup> , 3RT2.4 <sup>2)3)</sup>	S2, S3		24 ... 90 90 ... 240	0.05 ... 100 (1, 10, 100; selectable)	<b>3RA2832-1DG10</b> <b>3RA2832-1DH10</b>	<b>3RA2832-2DG10</b> <b>3RA2832-2DH10</b>

##### For star-delta (wye-delta) starting

3RT2.1, 3RT2.2, 3RT2.3 <sup>2)</sup> , 3RT2.4 <sup>2)4)</sup>	S00 ... S3	<b>Varistor integrated</b> Comprising one basic module and two coupling modules The electrical connection between the function module and the contactor assembly is established automatically by snapping on and plugging in the connecting cables.	24 ... 240	0.5 ... 60 (10, 30, 60; selectable)	<b>3RA2816-0EW20</b>	<b>3RA2816-0EW20</b>
--	------------	---	------------	--	----------------------	----------------------

#### Accessories

3RA28	S00 ... S3	<b>Cover, sealable</b>			<b>3RA2910-0</b>	<b>3RA2910-0</b>
-------	------------	------------------------	--	--	------------------	------------------

- 1) AC voltage values apply for 50 and 60 Hz.
- 2) Cannot be fitted onto coupling relays and coupling contactor relays.
- 3) From product version E03 onwards, 3RA283. function modules can be used for 3RT2.4 contactors.
- 4) From product version E04 onwards, 3RA2816 function modules can be used for 3RT2.4 contactors.

Technical specifications, see page 3/79.

#### Assembly of reversing starters

We offer ready-made wiring kits for the assembly of reversing starters. Use of these wiring kits offers further advantages, see page 3/148.

# Switching devices – Contactors and contactor assemblies – for switching motors

## Power contactors for switching motors

### Accessories for SIRIUS 3RT contactors and SIRIUS 3RH2 contactor relays > Modules for contactor control

PU (UNIT, SET, M) = 1  
 PS\* = 1 unit  
 PG = 41B



#### More information

Equipment Manual for 3RA2711 function modules for IO-Link, see <https://support.industry.siemens.com/cs/ww/en/view/39319600>

Equipment Manual for 3RA2712 function modules for AS-Interface, see <https://support.industry.siemens.com/cs/ww/en/view/39318922>



3RA2711-1AA00 3RA2711-2AA00 3RA2711-1BA00 3RA2712-1CA00 3RA2711-2BA00 3RA2711-2CA00

For contactors	Size	Version	Screw terminals 	Spring-loaded terminals 
Type			Article No.	Price per PU
Type			Article No.	Price per PU
<b>SIRIUS 3RA27 function modules for direct-on-line starting</b>				
3RT201	S00	<b>IO-Link connection</b>	<b>3RA2711-1AA00</b>	<b>3RA2711-2AA00</b>
...	...	Includes one module connector for creating an IO-Link group		
3RT204 <sup>1)</sup>	S3	<b>AS-Interface integration</b>	<b>3RA2712-1AA00</b>	<b>3RA2712-2AA00</b>
<b>SIRIUS 3RA27 function modules for reversing starting<sup>2)</sup></b>				
3RT201	S00	<b>IO-Link connection</b>	<b>3RA2711-1BA00</b>	<b>3RA2711-2BA00</b>
...	...	Comprising one basic and one coupling module and an additional module connector <sup>3)</sup> for creating an IO-Link group		
3RT204 <sup>1)</sup>	S3	<b>AS-Interface integration</b>	<b>3RA2712-1BA00</b>	<b>3RA2712-2BA00</b>
Comprising one basic and one coupling module				
<b>Assembly kits for making 3-pole contactor assemblies</b>				
<a href="#">See page 3/104</a>				
<b>SIRIUS 3RA27 function modules for star-delta (wye-delta) starting<sup>4)</sup></b>				
3RT201	S00	<b>IO-Link connection</b>	<b>3RA2711-1CA00</b>	<b>3RA2711-2CA00</b>
...	...	Comprising one basic and two coupling modules and an additional module connector <sup>3)</sup> for creating an IO-Link group		
3RT204 <sup>1)</sup>	S3	<b>AS-Interface integration</b>	<b>3RA2712-1CA00</b>	<b>3RA2712-2CA00</b>
Comprising one basic and two coupling modules				
<b>Assembly kits for making 3-pole contactor assemblies</b>				
<a href="#">See page 3/105</a>				

<sup>1)</sup> From product version E06 onwards, 3RA271. function modules can be used for 3RT2.4 contactors.

<sup>2)</sup> For prewired reversing contactor assemblies with voltage tap-off, see pages 3/149 to 3/152. When these contactor assemblies are used, the assembly kit for the wiring is already integrated.

<sup>3)</sup> 3RA2711-0EE17 module connectors for size S3 must be ordered separately, see page 3/102.

<sup>4)</sup> For complete contactor assemblies for star-delta (wye-delta) starting including function modules, see pages 3/167 to 3/170.

Technical specifications for 3RA27 function modules, see page 3/80.

For contactors with voltage tap-off, see pages 3/53, 3/57, 3/61 and 3/63.

For IO-Link masters and AS-Interface masters, routers and power supply units, see "Industrial communication", page 2/1 onwards.

## Switching devices – Contactors and contactor assemblies – for switching motors

### Power contactors for switching motors

#### Accessories for SIRIUS 3RT contactors and SIRIUS 3RH2 contactor relays > Modules for contactor control



3RA2711-0EE10



3RA2711-0EE06



3RA2711-0EE15



3RA2910-0



3RA2711-0EE11





3RA6935-0A

For function modules	Version	Article No.	Price per PU	PU (UNIT, SET, M)	PS*	PG
Type						
<b>Accessories for 3RA27 function modules</b>						
3RA2711-...A00	<b>Module connector set</b> Comprising: • Two module connectors (14-pole, short) • Two interface covers	<b>3RA2711-0EE10</b>		1	1 unit	41B
3RA2711-...A00	<b>Module connectors</b> • 14-pole - 6 cm - 9 cm - 13 cm - 26 cm - 33.5 cm • 10-pole, 9 cm for the additional auxiliary voltage infeed  <u>Note:</u> Selection of module connectors, see <a href="#">Equipment Manual for 3RA2711 function modules for IO-Link</a> .	<b>3RA2711-0EE17</b> <b>3RA2711-0EE06</b> <b>3RA2711-0EE18</b> <b>3RA2711-0EE07</b> <b>3RA2711-0EE08</b> <b>3RA2711-0EE16</b>		1 1 1 1 1 1	1 unit 1 unit 1 unit 1 unit 1 unit 1 unit	41B 41B 41B 41B 41B 41B
3RA2711-...A00	<b>Interface covers</b> (set of 5)	<b>3RA2711-0EE15</b>		1	1 unit	41B
3RA2711-...A00	<b>Cover, sealable</b>	<b>3RA2910-0</b>		1	5 units	41B
<b>Operator panel for communication via IO-Link</b>						
3RA2711-...A00	<b>Operator panel (set)</b> Comprising: • 1 x operator panel • 1 x enabling module • 1 x interface cover • 1 x fixing terminal	<b>3RA6935-0A</b>		1	1 unit	42F
3RA2711-...A00	<b>Connecting cable</b> For connecting the operator panel to the coupling module Length 2 m, 10- to 14-pole	<b>3RA2711-0EE11</b>		1	1 unit	41B
3RA2711-...A00	<b>Enabling modules</b> (replacement)	<b>3RA6936-0A</b>		1	1 unit	42F
3RA2711-...A00	<b>Interface covers</b> (replacement)	<b>3RA6936-0B</b>		1	5 units	42F

# Switching devices – Contactors and contactor assemblies – for switching motors

## Power contactors for switching motors

### Accessories for SIRIUS 3RT contactors and SIRIUS 3RH2 contactor relays > Modules for contactor control

For contactors	Rated control supply voltage $U_s$	Time setting range $t$	Screw terminals 	PU (UNIT, SET, M)	PS*	PG	
Type	V	s	Article No.	Price per PU			
<b>Mechanical latching blocks (no switching state change in the event of voltage drop)</b>							
<b>Size S0</b>							
<b>For snapping onto the front of contactors</b>							
The contactor remains in the energized state in the event of voltage drop.							
	3RT202, 3RT232, 3RT252	24 AC/DC 110 AC/DC 230 AC/DC	-- -- --	<b>3RT2926-3AB31</b> <b>3RT2926-3AF31</b> <b>3RT2926-3AP31</b>	1 1 1	1 unit 1 unit 1 unit	41B 41B 41B
3RT2926-3A.31							
<b>OFF-delay devices for contactors with AC/DC and DC operation</b>							
<b>Sizes S00 to S3</b>							
<b>Non-adjustable delay time</b>							
	3RT201.-1BF4., 3RT202.-1BF4., 3RT203.-1NF3., 3RH2...-1BF40	110 AC/DC	S00: > 0.1 S0: > 0.08 S2: > 0.25	<b>3RT2916-2BK01</b>	1	1 unit	41B
	3RT201.-1BM4./-1BP4., 3RT202.-1BM4./-1BP4., 3RT203.-1NP3., 3RH2...-1BM40/-1BP40	220/230 AC/DC	S00: > 0.5 S0: > 0.3 S2: > 0.8	<b>3RT2916-2BL01</b>	1	1 unit	41B
3RT2916-2B.01	3RT201.-1BB4., 3RT202.-1BB4., 3RT203.-1NB3., 3RT204.-1NB3., 3RT244.-1NB3., 3RH2...-1BB40	24 DC	S00: > 0.2 S0: > 0.1 S2: > 0.1 S3: > 0.05	<b>3RT2916-2BE01</b>	1	1 unit	41B

# Switching devices – Contactors and contactor assemblies – for switching motors

## Power contactors for switching motors

### Accessories for SIRIUS 3RT contactors and SIRIUS 3RH2 contactor relays > Link modules

#### Selection and ordering data

For contactors	Size	Version	Article No.	Price per PU	PU (UNIT, SET, M)	PS*	PG
----------------	------	---------	-------------	--------------	-------------------	-----	----

Type

#### Safety main circuit connectors for two contactors



3RA2926-1A

3RT2.1	<b>S00</b>	For series connection of two contactors	<b>3RA2916-1A</b>		1	1 unit	41B
3RT2.2	<b>S0</b>		<b>3RA2926-1A</b>		1	1 unit	41B
3RT2.3	<b>S2</b>		<b>3RA2936-1A</b>		1	1 unit	41B

PU (UNIT, SET, M) = 1

PS\* = 1 unit (unless otherwise specified)

PG = 41B

For contactors	Size	Version	Article No.	Price per PU	Article No.	Price per PU
----------------	------	---------	-------------	--------------	-------------	--------------

Type

#### Assembly kits for reversing contactor assemblies for making 3-pole contactor assemblies



3RA2923-2AA1



3RA2923-2AA2



3RA2933-2AA1



3RA2943-2AA1



3RA2943-2AA2



3RA1953-2A



3RA1963-2A

3RT201	<b>S00-S00</b>	The assembly kit contains: Mechanical interlock, two connecting clips for two contactors, wiring modules on the top and bottom • For main, auxiliary and control circuits	<b>3RA2913-2AA1</b>		<b>3RA2913-2AA2</b>
3RT202	<b>S0-S0</b>	The assembly kit contains: Mechanical interlock, two connecting clips for two contactors, wiring modules on the top and bottom • For main, auxiliary and control circuits <sup>1)</sup> • Only for main circuit <sup>2)</sup>	<b>3RA2923-2AA1</b>		--
3RT203	<b>S2-S2</b>	The assembly kit contains: Two connectors for two contactors, wiring modules on the top and bottom (3RA2934-2B mechanical interlock must be ordered separately, <a href="#">see page 3/108</a> ) • For main and auxiliary circuits • Only for main circuit <sup>3)</sup>	<b>3RA2933-2AA1</b>		--
3RT204	<b>S3-S3</b>	The assembly kit contains: Two connectors for two contactors, wiring modules on the top and bottom (3RA2934-2B mechanical interlock must be ordered separately, <a href="#">see page 3/108</a> ) • For main and auxiliary circuits • Only for main circuit <sup>3)</sup>	<b>3RA2943-2AA1</b>		--
3RT1.5	<b>S6-S6</b>	The assembly kit contains: Wiring modules on the top and bottom	<b>3RA1953-2A</b>		<b>3RA1953-2A</b>
3RT1.6	<b>S10-S10</b>		<b>3RA1963-2A</b>		<b>3RA1963-2A</b>
3RT1.7	<b>S12-S12</b>		<b>3RA1973-2A</b>		<b>3RA1973-2A</b>

#### Screw terminals



#### Spring-loaded terminals



<sup>1)</sup> Use of the 3RA2923-2AA1 assembly kit in conjunction with the 3RT202-.....-3MA0 contactors is limited because the auxiliary switches in the basic unit are not allowed to be used on account of the permanently mounted auxiliary switch.

<sup>2)</sup> Version in size S0 with spring-loaded terminals:  
Only the wiring modules for the main circuit are included.  
No connecting clips are included for the auxiliary and control circuit.

<sup>3)</sup> Version in sizes S2 and S3 with spring-loaded terminals in the auxiliary and control circuits: Only the wiring modules for the main circuit are included.  
A cable set is included for the auxiliary circuit.



# Switching devices – Contactors and contactor assemblies – for switching motors

## Power contactors for switching motors

### Accessories for SIRIUS 3RT contactors and SIRIUS 3RH2 contactor relays > Link modules

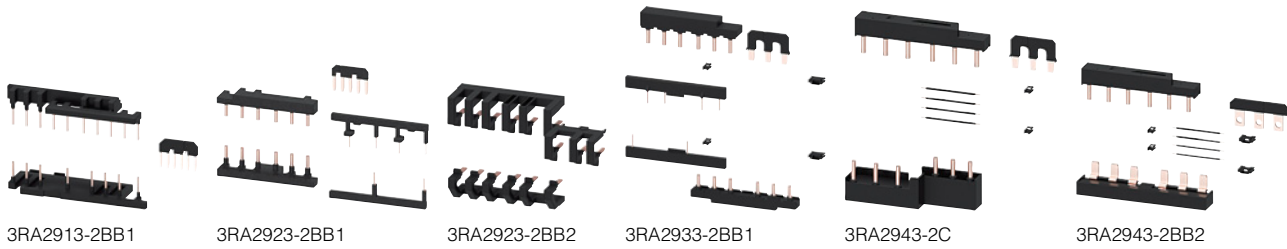
PU (UNIT, SET, M) = 1  
 PS\* = 1 unit (unless otherwise specified)  
 PG = 41B



For con- tactors	Size	Version	Screw terminals 		Spring-loaded terminals 	
			Article No.	Price per PU	Article No.	Price per PU
<b>Assembly kits<sup>1)</sup> for contactor assemblies for star-delta (wye-delta) starting for making 3-pole contactor assemblies</b>						
3RT201	<b>S00-S00-S00</b>	The assembly kit contains: Mechanical interlock, four connecting clips for three contactors, a star jumper, wiring modules on the top and bottom  • For main, auxiliary and control circuits	<b>3RA2913-2BB1</b>		<b>3RA2913-2BB2</b>	
3RT202	<b>S0-S0-S0</b>	The assembly kit contains: Mechanical interlock, four connecting clips for three contactors, a star jumper, wiring modules on the top and bottom  • For main, auxiliary and control circuits • Only for main circuit	<b>3RA2923-2BB1</b> --		-- <b>3RA2923-2BB2</b>	
3RT202	<b>S0-S0-S0</b>	The assembly kit contains: Mechanical interlock, four connecting clips for three contactors, a star jumper, wiring modules on the top and bottom, 3-phase infeed terminal  • For main, auxiliary and control circuits	<b>3RA2924-2BB1</b>		--	
3RT203	<b>S2-S2-S0</b>	The assembly kit <sup>2)</sup> contains: Two connectors for three contactors, an S0 star jumper, a spacer, wiring modules on the top and bottom (S2-S0) for the main circuit, a cable set for the auxiliary circuit, a cable for connecting the A2 coil contact of the line contactor to the A2 coil contact of the delta contactor	<b>3RA2933-2C</b>		<b>3RA2933-2C</b>	
3RT203	<b>S2-S2-S2</b>	The assembly kit <sup>2)</sup> contains: Four connectors for three contactors, an S2 star jumper, a cable for connecting the A2 coil contact of the line contactor to the A2 coil contact of the delta contactor and  • Wiring modules on the top and bottom for the main circuit and the auxiliary circuit • Wiring modules on the top and bottom for the main circuit, a cable set for the auxiliary circuit	<b>3RA2933-2BB1</b> --		-- <b>3RA2933-2BB2</b>	
3RT204	<b>S3-S3-S2</b>	The assembly kit <sup>2)</sup> contains: Two connectors for three contactors, an S2 star jumper, a spacer, wiring modules on the top and bottom (S3-S2) for the main circuit, a cable set for the auxiliary circuit, a cable for connecting the A2 coil contact of the line contactor to the A2 coil contact of the delta contactor	<b>3RA2943-2C</b>		<b>3RA2943-2C</b>	
3RT204	<b>S3-S3-S3</b>	The assembly kit <sup>2)</sup> contains: Four connectors for three contactors, an S3 star jumper, a cable for connecting the A2 coil contact of the line contactor to the A2 coil contact of the delta contactor and  • Wiring modules on the top and bottom for the main circuit and the auxiliary circuit • Wiring modules on the top and bottom for the main circuit, a cable set for the auxiliary circuit	<b>3RA2943-2BB1</b> --		-- <b>3RA2943-2BB2</b>	

<sup>1)</sup> When using the function modules for contactor assemblies for star-delta (wye-delta) starting, the wiring modules for the auxiliary current are not required.











<sup>2)</sup> The 3RA2934-2B mechanical interlock for sizes S2 and S3 must be ordered separately, see page 3/108.



# Switching devices – Contactors and contactor assemblies – for switching motors

## Power contactors for switching motors

### Accessories for SIRIUS 3RT contactors and SIRIUS 3RH2 contactor relays > Link modules













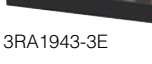

For contactors	Size	Version	Article No.	Price per PU	PU (UNIT, SET, M)	PS*	PG
Type							
<b>Assembly kits for contactor assemblies for star-delta (wye-delta) starting for making 3-pole contactor assemblies</b>							
			The assembly kit contains: link rails at bottom (a double infeed between the line contactor and the delta contactor is recommended.)				
 3RA1953-3G	3RT1.5, 3RT204	<b>S6-S6-S3</b> For connection with box terminal only	The S3 star jumper must be ordered separately, see page 3/107.	<b>3RA1953-3G</b>	1	1 unit	41B
	3RT1.5	<b>S6-S6-S6</b> For connection with box terminal only	--	<b>3RA1953-2B</b>	1	1 unit	41B
 3RA1953-2B							
	3RT1.5	<b>S6-S6-S6</b> For connection without box terminal	--	<b>3RA1953-2N</b>	1	1 unit	41B
 3RA1953-2N							
 3RA1963-3E	3RT1.6, 3RT1.5	<b>S10-S10-S6</b> For connection with box terminal only	The S6 star jumper must be ordered separately, see page 3/107.	<b>3RA1963-3E</b>	1	1 unit	41B
	3RT1.6	<b>S10-S10-S10</b> For connection without box terminal	--	<b>3RA1963-2B</b>	1	1 unit	41B
 3RA1963-2B							
 3RA1973-3E	3RT1.7, 3RT1.6	<b>S12-S12-S10</b> For connection with box terminal only	The S10 star jumper must be ordered separately, see page 3/107.	<b>3RA1973-3E</b>	1	1 unit	41B
	3RT1.7	<b>S12-S12-S12</b> For connection without box terminal	--	<b>3RA1973-2B</b>	1	1 unit	41B
 3RA1973-2B							

# Switching devices – Contactors and contactor assemblies – for switching motors

## Power contactors for switching motors

### Accessories for SIRIUS 3RT contactors and SIRIUS 3RH2 contactor relays > Link modules

PU (UNIT, SET, M) = 1  
 PS\* = 1 unit (unless otherwise specified)  
 PG = 41B

For con- tactors Type	Size	Version	Article No.	Price per PU	Article No.	Price per PU
<b>Single wiring modules for making 3-pole contactor assemblies</b>			<b>Screw terminals</b> 		<b>Spring-loaded terminals</b> 	
 3RA2913-3DA1	3RT201	<b>S00-S00</b> • Top (in-phase) • Bottom (with phase reversal)	PS = 5 units PS = 5 units	<b>3RA2913-3DA1</b> <b>3RA2913-3EA1</b>	<b>3RA2913-3DA2</b> <b>3RA2913-3EA2</b>	
 3RA2923-3DA1	3RT202	<b>S0-S0</b> • Top (in-phase) • Bottom (with phase reversal)	PS = 5 units PS = 5 units	<b>3RA2923-3DA1</b> <b>3RA2923-3EA1</b>	<b>3RA2923-3DA2</b> <b>3RA2923-3EA2</b>	
 3RA1933-3D	3RT203	<b>S2-S2</b> • Top (in-phase), contactor clearance 10 mm • Bottom (with phase reversal), contactor clearance 10 mm		<b>3RA1933-3D</b> <b>3RA1933-3E</b>	<b>3RA1933-3D</b> <b>3RA1933-3E</b>	
 3RA1943-3E	3RT204	<b>S3-S3</b> • Top (in-phase), contactor clearance 10 mm • Bottom (with phase reversal), contactor clearance 10 mm		<b>3RA1943-3D</b> <b>3RA1943-3E</b>	<b>3RA1943-3D</b> <b>3RA1943-3E</b>	
 3RA1953-3D	3RT1.5	<b>S6-S6</b> • Top (in-phase, for connection with box terminal), contactor clearance 10 mm • Top (with phase reversal, for connection without box terminal), contactor clearance 10 mm		<b>3RA1953-3D</b> <b>3RA1953-3P</b>	<b>3RA1953-3D</b> <b>3RA1953-3P</b>	
<b>Star jumpers (links for paralleling), 3-pole</b>			<b>Screw terminals</b> 		<b>Spring-loaded terminals</b> 	
 3RT1916-4BA31	3RT201	<b>S00</b> <b>With through-hole</b> The links for paralleling can be reduced by one pole.		<b>3RT1916-4BA31</b>	<b>3RT2916-4BA32</b>	
 3RT2926-4BA32	3RT202	<b>S0</b> Without connecting terminal		<b>3RT1926-4BA31</b>	<b>3RT2926-4BA32</b>	
 3RT1936-4BA31	3RT203	<b>S2</b>		<b>3RT1936-4BA31</b>	<b>3RT1936-4BA31</b>	
 3RT1946-4BA31	3RT204	<b>S3</b>		<b>3RT1946-4BA31</b>	<b>3RT1946-4BA31</b>	
 3RT1956-4BA31	3RT1.5	<b>S6</b>		<b>3RT1956-4BA31</b>	<b>3RT1956-4BA31</b>	
 3RT1966-4BA31	3RT1.6, 3RT1.7	<b>S10,</b> <b>S12</b>		<b>3RT1966-4BA31</b>	<b>3RT1966-4BA31</b>	

# Switching devices – Contactors and contactor assemblies – for switching motors

## Power contactors for switching motors

### Accessories for SIRIUS 3RT contactors and SIRIUS 3RH2 contactor relays > Link modules

For contactors	Size	Version	Article No.	Price per PU	PU (UNIT, SET, M)	PS*	PG
----------------	------	---------	-------------	--------------	-------------------	-----	----

Type

#### Mechanical interlock assembly kits for two contactors for making 3- and 4-pole contactor assemblies



3RA2922-2H

3RT201, 3RT231	<b>S00-S00</b>	The interlocking assembly kits can be used without a contactor clearance.	<b>3RA2912-2H</b>		1	10 units	41B
3RT202, 3RT232	<b>S0-S0</b>	One assembly kit consists of a mechanical interlock and two connecting clips.	<b>3RA2922-2H</b>		1	10 units	41B

For contactors	Size	Version	Article No.	Price per PU	PU (UNIT, SET, M)	PS*	PG
----------------	------	---------	-------------	--------------	-------------------	-----	----

Type

#### Mechanical interlocks for contactor assemblies



3RA2934-2B

A contactor clearance of 10 mm must be considered when using the following mechanical interlocks.							
3RT202, 3RT203	<b>S2-S2, S3-S3</b>	<b>Mechanical interlocks</b> Note:	<b>3RA2934-2B</b>		1	1 unit	41B
3RT202, 3RT203, 3RT204	<b>S2-S2-S0, S2-S2-S2, S3-S3-S2, S3-S3-S3</b>	The mechanical interlock for sizes S2 and S3 must be ordered separately.					

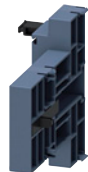

3RA1954-2G

3RT1.5 with 3RT204 <sup>1)</sup>	<b>S6 (3RT1)-S6 (3RT1)-S3 (3RT2)<sup>1)</sup></b>	<b>Adapter in addition to the mechanical interlock</b> The mechanical interlock is only possible together with this 3RA1954-2G adapter and the 3RA1954-2A mechanical interlock. Two connectors are included with the adapter, the interlock must be ordered separately.	<b>3RA1954-2G</b>		1	1 unit	41B
----------------------------------	---	---	-------------------	--	---	--------	-----



3RA1954-2A

3RT1.5, 3RT1.6, 3RT1.7	<b>S6, S10, S12</b>	<b>Mechanical interlocks</b> Without auxiliary contacts; contactors in sizes S6, S10 and S12 can be interlocked with each other as required. No adaption of mounting depth is necessary.	<b>3RA1954-2A</b>		1	1 unit	41B
------------------------	---------------------	---	-------------------	--	---	--------	-----

#### Mechanical connectors for contactor assemblies



3RA1932-2D

Two connectors are required for each assembly. The contactor clearance must be considered when selecting the connectors.							
<b>3-pole version</b>							
3RT203, 3RT204	<b>S2-S2, S3-S3</b>	• Without contactor clearance • With 10 mm contactor clearance	<b>3RA2932-2C</b> <b>3RA2932-2D</b>		1	10 units	41B
3RT105	<b>S6-S6</b>	• With 10 mm contactor clearance (1 unit corresponds to 2 parts for 1 assembly)	<b>3RA1932-2D</b>		1	10 units	41B



3RA2942-2G

<b>4-pole version</b>							
3RT233, 3RT234.	<b>S2-S2, S3-S3</b>	• With 20 mm contactor clearance • With 10 mm contactor clearance	<b>3RA2932-2G</b> <b>3RA2942-2G</b>		1	10 units	41B



3RA2942-2G





<sup>1)</sup> The 3RA1954-2G adapter cannot be used in conjunction with 3RT204...-KB coupling contactors, size S3.

# Switching devices – Contactors and contactor assemblies – for switching motors

## Power contactors for switching motors

### Accessories for SIRIUS 3RT contactors and SIRIUS 3RH2 contactor relays > Connection modules/adapters









#### Selection and ordering data

For contactors	Size	Version	Screw terminals	⊕	PU (UNIT, SET, M)	PS*	PG
Type			Article No.	Price per PU			
<b>Links for paralleling for main conducting paths</b>							
			The links for paralleling (insulated) can be reduced by one pole. With connecting terminal				
			<b>3-pole</b>				
	3RT201	<b>S00</b>	• Max. conductor cross-section: 25 mm <sup>2</sup> , stranded	<b>3RT1916-4BB31</b>	1	1 unit	41B
3RT1916-4BB31							
	3RT202	<b>S0</b>	• Max. conductor cross-section: 50 mm <sup>2</sup> , stranded	<b>3RT2926-4BB31</b>	1	1 unit	41B
3RT2926-4BB31							
	3RT203	<b>S2</b>	• Max. conductor cross-section: 120 mm <sup>2</sup> , stranded	<b>3RT1936-4BB31</b>	1	1 unit	41B
3RT1936-4BB31							
	3RT204, 3RT244	<b>S3</b>	• Max. conductor cross-section: 185 mm <sup>2</sup> , stranded A cover plate is included for touch protection (can only be used when box terminal is removed).	<b>3RT1946-4BB31</b>	1	1 unit	41B
3RT1946-4BB31							
			<b>4-pole</b>				
	3RT231, 3RT251	<b>S00</b>	• Max. conductor cross-section: 25 mm <sup>2</sup> , stranded	<b>3RT1916-4BB41</b>	1	1 unit	41B
3RT1916-4BB41							

# Switching devices – Contactors and contactor assemblies – for switching motors

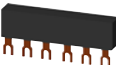
## Power contactors for switching motors

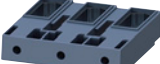
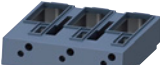
### Accessories for SIRIUS 3RT contactors and SIRIUS 3RH2 contactor relays > Connection modules/adapters

Type	For con- tactors	Size	Version	Article No.	Price per PU	PU (UNIT, SET, M)	PS*	PG
<b>1-phase infeed terminals</b>								
	3RT204, 3RT244, 3RT264	<b>S3</b>	Conductor cross-section: 95 mm <sup>2</sup>	<b>3RA2943-3L</b>		1	1 unit	41B
3RA2943-3L								
<b>3-phase infeed terminals</b>								
	3RT201	<b>S00</b>	Max. conductor cross-section: Up to 10 mm <sup>2</sup> , AWG 12 ... 8	<b>3RA2913-3K</b>		1	10 units	41B
3RA2913-3K								
	3RT202, 3RT262	<b>S0</b>	Max. conductor cross-section: Up to 25 mm <sup>2</sup> , AWG 10 ... 2/0	<b>3RV2925-5AB</b>		1	1 unit	41E
3RV2925-5AB								
	3RT203, 3RT263	<b>S2</b>	Max. conductor cross-section: Up to 70 mm <sup>2</sup> , AWG 10 ... 2/0	<b>3RV2935-5A</b>		1	1 unit	41E
3RV2935-5A								
<b>3-phase infeed terminals with increased clearance and creepage distances</b>								
	3RT203	<b>S2</b>	Max. conductor cross-section: Up to 70 mm <sup>2</sup> , AWG 10 ... 2/0	<b>3RV2935-5E</b>		1	1 unit	41E
3RV2935-5E								
<b>3-phase busbars</b>								
	3RT202	<b>S0</b>	Bridging phase-by-phase of all input terminals of the line contactor (Q11) and delta contactor (Q13)	<b>3RV1915-1AB</b>		1	1 unit	41E
3RV1915-1AB								
<b>Terminal blocks for connecting auxiliary conductors to main terminals</b>								
<b>Box terminal blocks</b>								
For round and ribbon cables (Connectable cross-sections of the contactors for size S3, see page 3/40 and for sizes 6 to S12, see page 3/44)								
	3RT204	<b>S3</b>	• 3-pole, for connection of main contacts, 2.5 to 70 mm <sup>2</sup>	<b>3RT2946-4G</b>		1	1 unit	41B
3RT2946-4G								
	3RT1.5	<b>S6</b>	• Up to 70 mm <sup>2</sup> , as standard on 3RT1054-1 contactor (55 kW)	<b>3RT1955-4G</b>		1	1 unit	41B
3RT1956-4G								
	3RT1.6, 3RT1.7	<b>S10, S12</b>	• Up to 240 mm <sup>2</sup> , with auxiliary conductor connection up to 2.5 mm <sup>2</sup>	<b>3RT1966-4G</b>		1	1 unit	41B
3RT1966-4G								
	3RT1.5	<b>S6</b>	<b>Box terminal for auxiliary conductor connection, 1-pole</b> For connection of auxiliary and control cables (0.5 ... 2.5 mm <sup>2</sup> ) to the main conductor terminals	<b>3TX7500-0A</b>		1	1 unit	41B
3TX7500-0A								
	3RT204	<b>S3</b>	<b>Auxiliary conductor terminals, 3-pole</b> For connection of auxiliary and control cables (0.5 ... 2.5 mm <sup>2</sup> ) to the main conductor terminals	<b>3RT2946-4F</b>		1	1 unit	41B
3RT2946-4F								

## Switching devices – Contactors and contactor assemblies – for switching motors

### Power contactors for switching motors

#### Accessories for SIRIUS 3RT contactors and SIRIUS 3RH2 contactor relays > Connection modules/adapters

















For contactors	Size	Version	Article No.	Price per PU	PU (UNIT, SET, M)	PS*	PG
<b>Solder pin adapters for mounting contactors on printed circuit boards up to 5.5 kW/12 A</b>							
Type			<b>Screw terminals</b> 				
	3RT2.1, 3RH21	<b>S00</b>	Assembly kit for soldering contactors with an integrated auxiliary contact onto a printed circuit board <u>Note:</u> One kit is required for one contactor.	<b>3RT1916-4KA1</b>	1	4 units	41B
	3RT1916-4KA1						
	3RT2.1, 3RH21	<b>S00</b>	Assembly kit for soldering contactors with 4-pole mounted auxiliary switch onto a printed circuit board <u>Note:</u> One kit is required for one contactor.	<b>3RT1916-4KA2</b>	1	4 units	41B
	3RT1916-4KA2						
	3RT1916-4KA2						
<b>Coil connection modules for connections from top or from below</b>							
	3RT2.2, 3RT2.3, 3RT2.4	<b>S0 to S3</b>	<ul style="list-style-type: none"> <li>• Connection from top</li> <li>• Connection from below</li> <li>• Connection diagonally</li> </ul>	<b>3RT2926-4RA11</b>	1	1 unit	41B
				<b>3RT2926-4RB11</b>	1	1 unit	41B
				<b>3RT2926-4RC11</b>	1	1 unit	41B
				<b>Spring-loaded terminals</b> 			
	3RT2.2	<b>S0</b>	<ul style="list-style-type: none"> <li>• Connection from top</li> <li>• Connection from below</li> </ul>	<b>3RT2926-4RA12</b>	1	1 unit	41B
				<b>3RT2926-4RB12</b>	1	1 unit	41B
<b>Connection module (adapter and plug) for contactors with screw terminals</b>							
Type			<b>Screw terminals</b> 				
			Article No.	Price per PU	PU (UNIT, SET, M)	PS*	PG
	3RT201, 3RH2	<b>S00</b>	The connection module comprises an adapter and a motor feeder connector. <b>Adapters</b> Ambient temperature $t_{u \max} = 60 \text{ °C}$	<b>3RT1916-4RD01</b>	1	1 unit	41B
	3RT202	<b>S0</b>	<ul style="list-style-type: none"> <li>• Rated operational current <math>I_{\theta}</math> at AC-3/AC-3e/400 V: 20 A</li> </ul>	<b>3RT1926-4RD01</b>	1	1 unit	41B
	3RT201, 3RT202, 3RH2	<b>S00, S0</b>	<b>Motor feeder connector</b>	<b>3RT1900-4RE01</b>	1	1 unit	41B

# Switching devices – Contactors and contactor assemblies – for switching motors

## Power contactors for switching motors

### Accessories for SIRIUS 3RT contactors and SIRIUS 3RH2 contactor relays > Covers

#### Selection and ordering data

For contactors	Size	Version	Article No.	Price per PU	PU (UNIT, SET, M)	PS*	PG
<b>Terminal covers</b>							
<b>Covers for contactors with screw terminals (box terminals)</b> (2 units required per contactor)							
		3RT203 <b>S2</b> 3RT204, 3RT244 <b>S3</b>	• For 3-pole contactors <b>3RT2936-4EA2</b>		1	1 unit	41B
		3RT1.5 <b>S6<sup>1)</sup></b> 3RT1.6, 3RT1.7 <b>S10<sup>1)</sup>, S12<sup>1)</sup></b>	<b>3RT2946-4EA2</b>		1	1 unit	41B
		3RT233, 3RT253 <b>S2</b> 3RT234, 3RT254 <b>S3</b>	• For 4-pole contactors (Scope of supply: one 3-pole and two 1-pole terminal covers are supplied) <b>3RT2936-4EA4</b>		1	1 unit	41B
<b>Covers for contactors with cable lugs and busbar connections</b>							
		3RT2.4 <b>S3</b>	• For complying with the phase clearances and as touch protection if box terminal is removed (2 units required per contactor) - Length: 100 mm <b>3RT1946-4EA1</b>		1	1 unit	41B
		3RT1.5 <b>S6<sup>1)</sup></b> 3RT1.6, 3RT1.7 <b>S10<sup>1)</sup>, S12<sup>1)</sup></b>	- Length: 100 mm <b>3RT1956-4EA1</b>		1	1 unit	41B
		3RT1.5 <b>S6</b>	• For the assembly kits for 3RA1953-... contactor assemblies for star-delta (wye-delta) starting (see page 3/106) or for the 3RA1953-3 single wiring modules. (see page 3/107) - Length: 38 mm <b>3RT1966-4EA1</b>		1	1 unit	41B
		3RT1.6, 3RT1.7 <b>S10, S12</b>	• For the assembly kits for reversing contactor assemblies and contactor assemblies for star-delta (wye-delta) starting - Length: 42 mm <b>3RT1956-4EA4</b>		1	1 unit	41B
<b>Terminal covers for busbar connections</b>							
		3RT1.5 <b>S6</b> 3RT1.6, 3RT1.7 <b>S10, S12</b>	• Cover the three busbar connections, between the contactor and 3RB2 overload relay - Length: 27 mm <b>3RT1956-4EA3</b>		1	1 unit	41B
		3RT1.5 <b>S6</b> 3RT1.6, 3RT1.7 <b>S10, S12</b>	• Can be screwed on free screw end; covers one busbar connection (1 set = 6 units) - M8 <b>3RT1966-4EA3</b>		1	1 unit	41B
		3RT2.1, 3RT2.2, 3RT2.3, 3RT2.4, 3RH2 <sup>2)</sup> <b>S00 ... S3</b> 3RT1.5 <b>S6 ... S12</b> ... 3RT1.7 <sup>2)</sup>	For preventing manual operation (Not suitable for coupling contactors) <b>3TX6526-3B</b>		1	5 units	41B
			<b>3TX6546-3B</b>		1	1 unit	41B
			<b>3RT2916-4MA10</b>		1	5 units	41B
			<b>3RT1926-4MA10</b>		1	5 units	41B

<sup>1)</sup> Also fits on contactors of sizes S6 to S12 with box terminals.

<sup>2)</sup> Exception: Contactors and contactor relays with auxiliary switch mounted on the front.













# Switching devices – Contactors and contactor assemblies – for switching motors

## Power contactors for switching motors

### Accessories for SIRIUS 3RT contactors and SIRIUS 3RH2 contactor relays > Miscellaneous accessories



#### Selection and ordering data

For contactors	Size	Version	Article No.	Price per PU	PU (UNIT, SET, M)	PS*	PG
<b>Base plates</b>							
<b>For reversing contactor assemblies</b>							
	3RT1.5	<b>S6</b>	For customer assembly of reversing contactor assemblies	<b>3RA1952-2A</b>	1	1 unit	41B
	3RT1.6	<b>S10</b>		<b>3RA1962-2A</b>	1	1 unit	41B
	3RT1.7	<b>S12</b>		<b>3RA1972-2A</b>	1	1 unit	41B
<b>For contactor assemblies for star-delta (wye-delta) starting</b>							
	3RT2/ 3RT2/ 3RT2	<b>S2-S2-S0,</b> <b>S2-S2-S2,</b> <b>S3-S3-S2,</b> <b>S3-S3-S3</b>	For configuring contactor assemblies for star-delta (wye-delta) starting	<b>3RA2932-2F</b>	1	1 unit	41B
				<b>3RA2942-2F</b>	1	1 unit	41B
							
	3RT1/ 3RT1/ 3RT2	<b>S6-S6-S3</b>	For customer assembly of contactor assemblies for star-delta (wye-delta) starting with a <b>laterally mounted</b> timing relay 10 mm clearance between the contactors	<b>3RA1952-2E</b>	1	1 unit	41B
	3RT1/ 3RT1/ 3RT1	<b>S6-S6-S6</b>		<b>3RA1952-2F</b>	1	1 unit	41B
		<b>S10-S10-S6</b>		<b>3RA1962-2E</b>	1	1 unit	41B
		<b>S10-S10-S10</b>		<b>3RA1962-2F</b>	1	1 unit	41B
		<b>S12-S12-S10</b>		<b>3RA1972-2E</b>	1	1 unit	41B
		<b>S12-S12-S12</b>		<b>3RA1972-2F</b>	1	1 unit	41B
<b>Adapters for screw fixing</b>							
	3RT2.2	<b>S0</b>	Screw adapters for securing the contactors, two units required per contactor (1 pack = 10 sets for 10 contactors)	<b>3RT1926-4P</b>	1	10 units	41B
<b>Connection kit for one complete contactor</b>							
	3RT105	<b>S6</b>	Each set includes 6 screws, spring washers and nuts.	<b>3RT1955-4PA00</b>	1	1 unit	41B
	3RT106, 3RT107	<b>S10, S12</b>		M 10 x 30	<b>3RT1966-4PA00</b>	1	1 unit
							
<b>EMC suppression modules; 3-phase, up to 7.5 kW</b>							
<b>For contactors with AC or DC operation</b>							
	3RT201	<b>S00</b>	<b>RC elements</b> (3 x 220 Ω/0.22 μF) • Up to 400 V • Up to 575 V • Up to 690 V	<b>Screw terminals</b> 			
				<b>3RT2916-1PA1</b>	1	1 unit	41B
				<b>3RT2916-1PA2</b>	1	1 unit	41B
			<b>3RT2916-1PA3</b>	1	1 unit	41B	
			<b>Varistors</b> • Up to 400 V • Up to 575 V • Up to 690 V	<b>3RT2916-1PB1</b>	1	1 unit	41B
				<b>3RT2916-1PB2</b>	1	1 unit	41B
		<b>3RT2916-1PB3</b>		1	1 unit	41B	

## Switching devices – Contactors and contactor assemblies – for switching motors

### Power contactors for switching motors





#### Accessories for SIRIUS 3RT contactors and SIRIUS 3RH2 contactor relays > Miscellaneous accessories

For con- tactors	Size	Version	Article No.	Price per PU	PU (UNIT, SET, M)	PS*	PG
Type							
<b>Additional load modules</b>							
 3RT2916-1GA00	3RT2.1, 3RH2	<b>S00</b>	For plugging onto the front of the contactors with or without auxiliary switches  For increasing the permissible residual current and for limiting the residual voltage, it ensures the safe opening of contactors with direct control via 230 V AC semiconductor outputs of SIMATIC controllers, simultaneously provides overvoltage damping  Rated voltage: 50/60 Hz AC, 180 ... 255 V Operating range: 0.8 ... 1.1 x $U_s$	<b>3RT2916-1GA00</b>	1	1 unit	41B
<b>LED modules for displaying contactor operation</b>							
 3RT2926-1QT00	3RT2, 3RT1	<b>S00 ... S12</b>	For snapping into the location hole of an inscription label on the front of a contactor either directly on the contactor or on the front auxiliary switch.  The LED module is connected to coil terminals A1 and A2 of the contactor and indicates its energized state with a yellow LED. Connecting leads need to be extended as required.  Rated voltage: 24 ... 240 V AC/DC with reverse polarity protection	<b>3RT2926-1QT00</b>	1	5 units	41B
<b>Control kit</b>							
 3RT2916-4MC00	3RT2.1, 3RH2	<b>S00</b>	For manual operation of contactor contacts, for startup and service	<b>3RT2916-4MC00</b>	1	5 units	41B
	3RT2.2	<b>S0</b>		<b>3RT2926-4MC00</b>	1	5 units	41B
	3RT2.3, 3RT2.4	<b>S2, S3</b>		<b>3RT2936-4MC00</b>	1	5 units	41B

# Switching devices – Contactors and contactor assemblies – for switching motors

## Power contactors for switching motors

### Accessories for SIRIUS 3RT contactors and SIRIUS 3RH2 contactor relays > Miscellaneous accessories

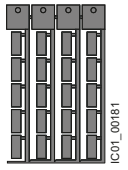
For contactors	Size	Version	Article No.	Price per PU	PU (UNIT, SET, M)	PS*	PG
<b>Insulation stop for securely holding back the conductor insulation for conductors up to 1 mm<sup>2</sup></b>							
 3RT2916-4JA02  3RT1916-4JA02			<b>Insulation stop strip</b> Can be inserted in cable entry of the spring-loaded terminal (two strips per contactor required) <ul style="list-style-type: none"> <li>For basic units, removable individually</li> <li>For auxiliary and control current on basic units and for mountable 3RH29 auxiliary switches, removable in pairs</li> </ul>	<b>Spring-loaded terminals</b> 			
3RT2.1, 3RH2	S00		<b>3RT2916-4JA02</b>		1	20 units	41B
3RT2.2 ... 3RT2.4, 3RT1, 3RH29	S0 ... S12		<b>3RT1916-4JA02</b>		1	20 units	41B
<b>Tools for opening spring-loaded terminals</b>							
 3RT, 3RH 3RA2908-1A			<b>Screwdrivers</b> For all SIRIUS devices with spring-loaded terminals Length: approx. 200 mm, 3,0 mm x 0,5 mm, titanium gray/black, partially insulated	<b>3RA2908-1A</b>		1	1 unit 41B
<b>Blank labels</b>							
 3RT2900-1SB20			<b>Unit labeling plates<sup>1)</sup></b> For SIRIUS devices <ul style="list-style-type: none"> <li>10 mm x 7 mm, titanium gray</li> <li>20 mm x 7 mm, titanium gray</li> </ul>	<b>3RT2900-1SB10</b> <b>3RT2900-1SB20</b>		100	816 units 41B 340 units 41B
3RT	S00 ... S12		<b>3RT2900-1SB60</b>		100	3060 units	41B
			<b>Adhesive labels</b> For SIRIUS devices <ul style="list-style-type: none"> <li>19 mm x 6 mm, titanium gray</li> </ul>				

<sup>1)</sup> PC labeling system for individual inscription of unit labeling plates available from: murrplastik Systemtechnik GmbH (see page 16/18).

## Switching devices – Contactors and contactor assemblies – for switching motors

### Power contactors for switching motors

#### Spare parts for SIRIUS 3RT contactors and SIRIUS 3RH2 contactor relays > Solenoid coils

#### Selection and ordering data

##### Screw terminals and spring-loaded terminals

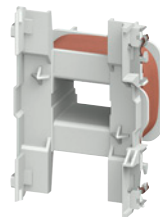

3RT2924-5A.01

For contactors	Rated control supply voltage $U_s$			Article No.	Price per PU	PU (UNIT, SET, M)	PS*	PG
	50 Hz	50/60 Hz	60 Hz					
Type	V	V	V					
<b>Solenoid coils · AC operation</b>								
<b>Size S0</b>								
3RT2023-A,	24	--	--	<b>3RT2924-5AB01</b>		1	1 unit	41B
3RT2024-A,	42	--	--	<b>3RT2924-5AD01</b>		1	1 unit	41B
3RT2025-A	48	--	--	<b>3RT2924-5AH01</b>		1	1 unit	41B
	110	--	--	<b>3RT2924-5AF01</b>		1	1 unit	41B
	230	--	--	<b>3RT2924-5AP01</b>		1	1 unit	41B
	400	--	--	<b>3RT2924-5AV01</b>		1	1 unit	41B
	--	24	--	<b>3RT2924-5AC21</b>		1	1 unit	41B
	--	42	--	<b>3RT2924-5AD21</b>		1	1 unit	41B
	--	48	--	<b>3RT2924-5AH21</b>		1	1 unit	41B
	--	110	--	<b>3RT2924-5AG21</b>		1	1 unit	41B
	--	220	--	<b>3RT2924-5AN21</b>		1	1 unit	41B
	--	230	--	<b>3RT2924-5AL21</b>		1	1 unit	41B
	--	--	24	<b>3RT2924-5AC11</b>		1	1 unit	41B
	110	--	120	<b>3RT2924-5AK61</b>		1	1 unit	41B
	220	--	240	<b>3RT2924-5AP61</b>		1	1 unit	41B
	--	100	110	<b>3RT2924-5AG61</b>		1	1 unit	41B
	--	200	220	<b>3RT2924-5AN61</b>		1	1 unit	41B
	--	400	440	<b>3RT2924-5AR61</b>		1	1 unit	41B
3RT2026-A,	24	--	--	<b>3RT2926-5AB01</b>		1	1 unit	41B
3RT2027-A,	42	--	--	<b>3RT2926-5AD01</b>		1	1 unit	41B
3RT2028-A	48	--	--	<b>3RT2926-5AH01</b>		1	1 unit	41B
3RT2325-A,	110	--	--	<b>3RT2926-5AF01</b>		1	1 unit	41B
3RT2326-A,	230	--	--	<b>3RT2926-5AP01</b>		1	1 unit	41B
3RT2327-A	400	--	--	<b>3RT2926-5AV01</b>		1	1 unit	41B
3RT2526-A	--	24	--	<b>3RT2926-5AC21</b>		1	1 unit	41B
	--	42	--	<b>3RT2926-5AD21</b>		1	1 unit	41B
	--	48	--	<b>3RT2926-5AH21</b>		1	1 unit	41B
	--	110	--	<b>3RT2926-5AG21</b>		1	1 unit	41B
	--	220	--	<b>3RT2926-5AN21</b>		1	1 unit	41B
	--	230	--	<b>3RT2926-5AL21</b>		1	1 unit	41B
	--	--	24	<b>3RT2926-5AC11</b>		1	1 unit	41B
	110	--	120	<b>3RT2926-5AK61</b>		1	1 unit	41B
	220	--	240	<b>3RT2926-5AP61</b>		1	1 unit	41B
	--	100	110	<b>3RT2926-5AG61</b>		1	1 unit	41B
	--	200	220	<b>3RT2926-5AN61</b>		1	1 unit	41B
	--	400	440	<b>3RT2926-5AR61</b>		1	1 unit	41B

#### Note:

Contactors with AC and AC/DC coils have different depths. It is only possible to replace the coils on AC contactors with AC coils. It is not possible to replace the coils on DC contactors.

# Switching devices – Contactors and contactor assemblies – for switching motors

## Power contactors for switching motors

### Spare parts for SIRIUS 3RT contactors and SIRIUS 3RH2 contactor relays > Solenoid coils

#### Screw terminals and spring-loaded terminals

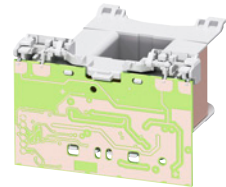
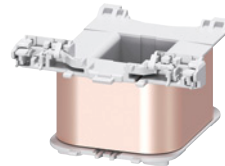
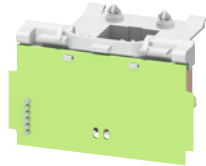
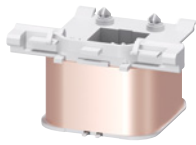

3RT2934-5A.01

3RT2934-5N.31

3RT2944-5A..1

3RT2944-5N.31

For contactors	Rated control supply voltage $U_s$				Article No.	Price per PU	PU (UNIT, SET, M)	PS*	PG
	50 Hz	50/60 Hz	60 Hz	DC					
Type	V	V	V						

#### Solenoid coils · AC operation

##### Size S2

3RT203.-A,	24	--	--	--	3RT2934-5AB01	1	1 unit	41B
3RT233.-A,	42	--	--	--	3RT2934-5AD01	1	1 unit	41B
3RT243.-A,	48	--	--	--	3RT2934-5AH01	1	1 unit	41B
3RT253.-A	110	--	--	--	3RT2934-5AF01	1	1 unit	41B
	230	--	--	--	3RT2934-5AP01	1	1 unit	41B
	400	--	--	--	3RT2934-5AV01	1	1 unit	41B
	--	24	--	--	3RT2934-5AC21	1	1 unit	41B
	--	42	--	--	3RT2934-5AD21	1	1 unit	41B
	--	48	--	--	3RT2934-5AH21	1	1 unit	41B
	--	110	--	--	3RT2934-5AG21	1	1 unit	41B
	--	208	--	--	3RT2934-5AM21	1	1 unit	41B
	--	220	--	--	3RT2934-5AN21	1	1 unit	41B
	--	230	--	--	3RT2934-5AL21	1	1 unit	41B
	110	--	120	--	3RT2934-5AK61	1	1 unit	41B
	220	--	240	--	3RT2934-5AP61	1	1 unit	41B
	--	--	480	--	3RT2934-5AV61	1	1 unit	41B
	--	--	600	--	3RT2934-5AT61	1	1 unit	41B
	--	100	110	--	3RT2934-5AG61	1	1 unit	41B
	--	200	220	--	3RT2934-5AN61	1	1 unit	41B
	--	--	277	--	3RT2934-5AU61	1	1 unit	41B
	--	400	440	--	3RT2934-5AR61	1	1 unit	41B

##### Size S3

3RT204.-A,	24	--	--	--	3RT2944-5AB01	1	1 unit	41B
3RT234.-A,	42	--	--	--	3RT2944-5AD01	1	1 unit	41B
3RT244.-A,	48	--	--	--	3RT2944-5AH01	1	1 unit	41B
3RT254.-A	110	--	--	--	3RT2944-5AF01	1	1 unit	41B
	230	--	--	--	3RT2944-5AP01	1	1 unit	41B
	400	--	--	--	3RT2944-5AV01	1	1 unit	41B
	--	24	--	--	3RT2944-5AC21	1	1 unit	41B
	--	42	--	--	3RT2944-5AD21	1	1 unit	41B
	--	48	--	--	3RT2944-5AH21	1	1 unit	41B
	--	110	--	--	3RT2944-5AG21	1	1 unit	41B
	--	220	--	--	3RT2944-5AN21	1	1 unit	41B
	--	230	--	--	3RT2944-5AL21	1	1 unit	41B
	110	--	120	--	3RT2944-5AK61	1	1 unit	41B
	220	--	240	--	3RT2944-5AP61	1	1 unit	41B
	--	--	480	--	3RT2944-5AV61	1	1 unit	41B
	--	--	600	--	3RT2944-5AT61	1	1 unit	41B
	--	100	110	--	3RT2944-5AG61	1	1 unit	41B
	--	200	220	--	3RT2944-5AN61	1	1 unit	41B
	--	400	440	--	3RT2944-5AR61	1	1 unit	41B

#### Solenoid coils · AC/DC operation, with varistor

##### Size S2

3RT203.-N,	--	20 ... 33	--	20 ... 33	3RT2934-5NB31	1	1 unit	41B
3RT233.-N	--	30 ... 42	--	30 ... 42	3RT2934-5ND31	1	1 unit	41B
	--	48 ... 80	--	48 ... 80	3RT2934-5NE31	1	1 unit	41B
	--	83 ... 155	--	83 ... 155	3RT2934-5NF31	1	1 unit	41B
	--	175 ... 280	--	175 ... 280	3RT2934-5NP31	1	1 unit	41B

##### Size S3

3RT204.-N,	--	20 ... 33	--	20 ... 33	3RT2944-5NB31	1	1 unit	41B
3RT234.-N,	--	30 ... 42	--	30 ... 42	3RT2944-5ND31	1	1 unit	41B
3RT244.-N,	--	48 ... 80	--	48 ... 80	3RT2944-5NE31	1	1 unit	41B
3RT254.-N	--	83 ... 155	--	83 ... 155	3RT2944-5NF31	1	1 unit	41B
	--	175 ... 280	--	175 ... 280	3RT2944-5NP31	1	1 unit	41B

#### Notes:

It is only possible to replace the coils on AC contactors with AC coils, and on AC/DC contactors with AC/DC coils.

Coil replacement is not permitted for 3RT20...-S contactors with fail-safe control.

# Switching devices – Contactors and contactor assemblies – for switching motors

## Power contactors for switching motors



### Spare parts for SIRIUS 3RT contactors and SIRIUS 3RH2 contactor relays > Solenoid coils

PU (UNIT, SET, M) = 1  
 PS\* = 1 unit  
 PG = 41B

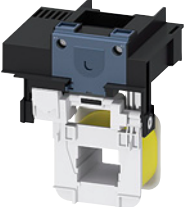

For contactors		Rated control supply voltage $U_s$	Screw terminals	Spring-loaded terminals
Size	Type	V	Article No.	Article No.
			Price per PU	Price per PU

#### Withdrawable coils

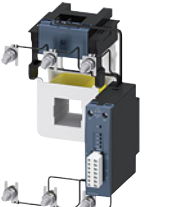

#### Standard operating mechanism for AC/DC

 3RT1955-5A.31	<b>S6</b>	3RT105, 3RT145	23 ... 26 AC/DC	3RT1955-5AB31	3RT1955-5AB32
			42 ... 48 AC/DC	3RT1955-5AD31	3RT1955-5AD32
			110 ... 127 AC/DC	3RT1955-5AF31	3RT1955-5AF32
			200 ... 220 AC/DC	3RT1955-5AM31	3RT1955-5AM32
			220 ... 240 AC/DC	3RT1955-5AP31	3RT1955-5AP32
			240 ... 277 AC/DC	3RT1955-5AU31	3RT1955-5AU32
			380 ... 420 AC/DC	3RT1955-5AV31	3RT1955-5AV32
			440 ... 480 AC/DC	3RT1955-5AR31	3RT1955-5AR32
			500 ... 550 AC/DC	3RT1955-5AS31	3RT1955-5AS32
			575 ... 600 AC/DC	3RT1955-5AT31	3RT1955-5AT32
 3RT1955-5A.32	<b>S10</b>	3RT106, 3RT146	23 ... 26 AC/DC	3RT1965-5AB31	3RT1965-5AB32
			42 ... 48 AC/DC	3RT1965-5AD31	3RT1965-5AD32
			110 ... 127 AC/DC	3RT1965-5AF31	3RT1965-5AF32
			200 ... 220 AC/DC	3RT1965-5AM31	3RT1965-5AM32
			220 ... 240 AC/DC	3RT1965-5AP31	3RT1965-5AP32
			240 ... 277 AC/DC	3RT1965-5AU31	3RT1965-5AU32
			380 ... 420 AC/DC	3RT1965-5AV31	3RT1965-5AV32
			440 ... 480 AC/DC	3RT1965-5AR31	3RT1965-5AR32
			500 ... 550 AC/DC	3RT1965-5AS31	3RT1965-5AS32
			575 ... 600 AC/DC	3RT1965-5AT31	3RT1965-5AT32
 3RT1975-5A.31	<b>S12</b>	3RT107, 3RT147	23 ... 26 AC/DC	3RT1975-5AB31	3RT1975-5AB32
			42 ... 48 AC/DC	3RT1975-5AD31	3RT1975-5AD32
			110 ... 127 AC/DC	3RT1975-5AF31	3RT1975-5AF32
			200 ... 220 AC/DC	3RT1975-5AM31	3RT1975-5AM32
			220 ... 240 AC/DC	3RT1975-5AP31	3RT1975-5AP32
			240 ... 277 AC/DC	3RT1975-5AU31	3RT1975-5AU32
			380 ... 420 AC/DC	3RT1975-5AV31	3RT1975-5AV32
			440 ... 480 AC/DC	3RT1975-5AR31	3RT1975-5AR32
			500 ... 550 AC/DC	3RT1975-5AS31	3RT1975-5AS32
			575 ... 600 AC/DC	3RT1975-5AT31	3RT1975-5AT32

#### Solid-state operating mechanism for AC/DC with 24 V DC control signal input e.g. for control by PLC

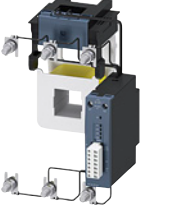

 3RT1955-5N.31	<b>S6</b>	3RT105, 3RT145	21 ... 27.3 AC/DC	3RT1955-5NB31	3RT1955-5NB32
			96 ... 127 AC/DC	3RT1955-5NF31	3RT1955-5NF32
			200 ... 277 AC/DC	3RT1955-5NP31	3RT1955-5NP32
 3RT1965-5N.31	<b>S10</b>	3RT106, 3RT146	21 ... 27.3 AC/DC	3RT1965-5NB31	3RT1965-5NB32
			96 ... 127 AC/DC	3RT1965-5NF31	3RT1965-5NF32
			200 ... 277 AC/DC	3RT1965-5NP31	3RT1965-5NP32
 3RT1975-5N.31	<b>S12</b>	3RT107, 3RT147	21 ... 27.3 AC/DC	3RT1975-5NB31	3RT1975-5NB32
			96 ... 127 AC/DC	3RT1975-5NF31	3RT1975-5NF32
			200 ... 277 AC/DC	3RT1975-5NP31	3RT1975-5NP32

#### • Additionally with PLC relay output and remaining lifetime indicator (RLT) (withdrawable coil with laterally mounted solid-state module)

 3RT1955-5P.31	<b>S6</b>	3RT105, 3RT145	96 ... 127 AC/DC	3RT1955-5PF31	--
			200 ... 277 AC/DC	3RT1955-5PP31	--
			3RT106, 3RT146	3RT1965-5PF31	--
 3RT1975-5P.31	<b>S10</b>	3RT106, 3RT146	200 ... 277 AC/DC	3RT1965-5PP31	--
			3RT107, 3RT147	3RT1975-5PF31	--
			200 ... 277 AC/DC	3RT1975-5PP31	--

#### Solid-state operating mechanism for DC with 24 ... 110 V DC control signal input e.g. for control by PLC with extended application range

(see also contactors for railway applications, page 4/61 onwards)

 3RT1955-5X.42	<b>S6</b>	3RT105...X...-0LA2	24 DC	--	3RT1955-5XB42
			72 DC	--	3RT1955-5XJ42
			110 DC	--	3RT1955-5XF42
 3RT1965-5X.42	<b>S10</b>	3RT106...X...-0LA2	24 DC	--	3RT1965-5XB42
			72 DC	--	3RT1965-5XJ42
			110 DC	--	3RT1965-5XF42
 3RT1975-5X.42	<b>S12</b>	3RT107...X...-0LA2	24 DC	--	3RT1975-5XB42
			72 DC	--	3RT1975-5XJ42
			110 DC	--	3RT1975-5XF42

#### Note:



In the case of 3RT10...-S contactors with fail-safe control inputs, removing and replacing the operating mechanism are not permitted.

# Switching devices – Contactors and contactor assemblies – for switching motors

## Power contactors for switching motors

Spare parts for SIRIUS 3RT contactors and SIRIUS 3RH2 contactor relays &gt; Contacts and arc chutes

## Selection and ordering data

For contactors	Version	Article No.	Price per PU	PU (UNIT, SET, M)	PS*	PG	
Size	Type						
<b>Contacts with fixing parts</b>							
<b>For contactors with 3 main contacts</b>							
	<b>S2<sup>1)</sup></b>	3RT2035 3RT2036 3RT2037 3RT2038	Main contacts (3 NO contacts) for utilization category AC-3 and AC-3e (1 set = 3 movable and 6 fixed contacts with fixing parts)	<b>3RT2935-6A</b> <b>3RT2936-6A</b> <b>3RT2937-6A</b> <b>3RT2938-6A</b>	1 1 1 1	1 unit 1 unit 1 unit 1 unit	41B 41B 41B 41B
	<b>S3<sup>1)</sup></b>	3RT2045 3RT2046 3RT2047		<b>3RT2945-6A</b> <b>3RT2946-6A</b> <b>3RT2947-6A</b>	1 1 1	1 unit 1 unit 1 unit	41B 41B 41B
	<b>S6</b>	3RT1054 3RT1055 3RT1056		<b>3RT1954-6A</b> <b>3RT1955-6A</b> <b>3RT1956-6A</b>	1 1 1	1 unit 1 unit 1 unit	41B 41B 41B
	<b>S10</b>	3RT1064 3RT1065 3RT1066		<b>3RT1964-6A</b> <b>3RT1965-6A</b> <b>3RT1966-6A</b>	1 1 1	1 unit 1 unit 1 unit	41B 41B 41B
<b>S12</b>	3RT1075 3RT1076		<b>3RT1975-6A</b> <b>3RT1976-6A</b>	1 1	1 unit 1 unit	41B 41B	
<b>S3</b>	3RT2446 3RT2448	Main contacts (3 NO contacts) for utilization category AC-1	<b>3RT2946-6D</b> <b>3RT2948-6D</b>	1 1	1 unit 1 unit	41B 41B	
<b>S6</b>	3RT1456	(1 set = 3 movable and 6 fixed contacts with fixing parts)	<b>3RT1956-6D</b>	1	1 unit	41B	
<b>S10</b>	3RT1466 3RT1467		<b>3RT1966-6D</b> <b>3RT1967-6D</b>	1 1	1 unit 1 unit	41B 41B	
<b>S12</b>	3RT1476		<b>3RT1976-6D</b>	1	1 unit	41B	
<b>For contactors with 4 main contacts</b>							
	<b>S2</b>	3RT2336 3RT2337	Main contacts (4 NO contacts) for utilization category AC-1 (1 set = 3 movable and 6 fixed contacts and spare pole with fixing parts)	<b>3RT2936-6E</b> <b>3RT2937-6E</b>	1 1	1 unit 1 unit	41B 41B
<b>Arc chutes</b>							
<b>For contactors with 3 main contacts</b>							
	<b>S6</b>	3RT1054 3RT1055 3RT1056 3RT1456	Only for contactors with AC/DC coil	<b>3RT1954-7A</b> <b>3RT1955-7A</b> <b>3RT1956-7A</b> <b>3RT1956-7B</b>	1 1 1 1	1 unit 1 unit 1 unit 1 unit	41B 41B 41B 41B
	<b>S10</b>	3RT1064 3RT1065 3RT1066 3RT1466		<b>3RT1964-7A</b> <b>3RT1965-7A</b> <b>3RT1966-7A</b> <b>3RT1966-7B</b>	1 1 1 1	1 unit 1 unit 1 unit 1 unit	41B 41B 41B 41B
	<b>S12</b>	3RT1075 3RT1076 3RT1476		<b>3RT1975-7A</b> <b>3RT1976-7A</b> <b>3RT1976-7B</b>	1 1 1	1 unit 1 unit 1 unit	41B 41B 41B
<b>S6</b>	3RT1054 3RT1055 3RT1056 3RT1456	Only for contactors with AC/DC coil	<b>3RT1954-7A</b> <b>3RT1955-7A</b> <b>3RT1956-7A</b> <b>3RT1956-7B</b>	1 1 1 1	1 unit 1 unit 1 unit 1 unit	41B 41B 41B 41B	
<b>S10</b>	3RT1064 3RT1065 3RT1066 3RT1466		<b>3RT1964-7A</b> <b>3RT1965-7A</b> <b>3RT1966-7A</b> <b>3RT1966-7B</b>	1 1 1 1	1 unit 1 unit 1 unit 1 unit	41B 41B 41B 41B	
<b>S12</b>	3RT1075 3RT1076 3RT1476		<b>3RT1975-7A</b> <b>3RT1976-7A</b> <b>3RT1976-7B</b>	1 1 1	1 unit 1 unit 1 unit	41B 41B 41B	

<sup>1)</sup> Switching of the spare contact is not permitted for 3RT20...-S contactors with fail-safe control.



## Switching devices – Contactors and contactor assemblies – for switching motors

### Power contactors for switching motors

#### SIRIUS 3RT12 and 3TF6 vacuum contactors

##### Overview



3RT12 and 3TF6 vacuum contactors

Our power range of vacuum contactors for switching IE2 motors and highly efficient IE3 and IE4 motors:

- Sizes S10 and S12: 3RT12 up to 250 kW
- Size 14: 3TF6 up to 450 kW

See from page 3/120 onwards

##### Standards

IEC 60947-1, IEC 60947-4-1, IEC 60947-5-1 (auxiliary switches)

Terminal covers may have to be fitted onto the connecting bars, depending on the configuration with other devices (see pages 3/112 and 3/134).

##### Operating conditions

Vacuum contactors are basically unsuitable for switching DC voltage. Vacuum contactors are only approved **for applications in the frequency range 45 to 60 Hz**. Help with applications > 60 Hz is available from our Technical Support, [www.siemens.com/support-request](http://www.siemens.com/support-request).

##### Protection of the device connections from short circuit, overload and overvoltage

Appropriate steps must always be taken to protect device connections from overload and short circuit. There are different constraints depending on the type of connection:

##### Protection of main terminals from short circuit and overload

For information about protection of a single contactor, see the [technical product data sheet](#).

For more information on complete units such as contactors with overload relays or contactors with motor starter protectors as the motor feeder, see [Configuration Manual for load feeders](#).

##### Protection of auxiliary connections from short circuit and overload

For information about protection of auxiliary contacts, see the [technical product data sheet](#).

##### Protection of control supply voltage or supply voltage connections from short circuit and overload

First of all, the relevant standards and regulations for configuring control panels and the parts and components installed in them must be taken into account, for example when dimensioning the cables.

One possible protection for these circuits could be the selection of a suitable power supply, i.e. one with a current-limiting function. In the selection of the source and the connecting cable, the load characteristics of the contactor must be considered (short-time inrush current peaks for solid-state contactor operating mechanisms, closing, closed).

If there are further switching elements in the circuit, such as the auxiliary contact system of an overload relay that operates the contactor, the short-circuit protection necessary for this must also be considered.

For further recommendations, e.g. the use of miniature circuit breakers or circuit breakers for equipment in control circuits, see [Control panel tip – Fast, reliable selection and dimensioning of an appropriate power supply unit](#).

##### Protection of contactors with digital input from short circuit and overload

For the PLC input types according to IEC 60947-4-1 these inputs have a typical rated current of 20 mA.

These inputs can be protected accordingly (for 3RT12...N contactors marked with IN+/IN-).

The supply voltage connections A1 - A2 must be protected according to the load characteristics.

For information about power consumption, see the [technical product data sheet](#).

##### Overvoltage protection at the control supply voltage connection

The 3RT12 contactors are already equipped with coil damping (varistor).

##### Note:

The break times of the contactor, the opening delay times of the NO contacts and the closing delay times of the NC contacts increase with damping.

For more detailed information about how damping affects the time response, see [Equipment Manual](#).

##### Protection from overvoltage in the main circuit

The 3RT12 and 3TF6 vacuum contactors can be retrofitted with varistors for damping switching overvoltages in the coil.

The 3TF6 contactors have integrated damping depending on the version.

##### Note:

When the 3TF6 contactors are used in an **environment with frequency converters**, the overvoltage damping (if any) must always be removed.

For more information, see [Equipment Manual](#).

##### Connection methods

##### Main circuit

3RT12 vacuum contactors are available with busbar connections. Box terminal blocks can be ordered separately as accessories for versions with screw terminals, see [page 3/134](#).

The 3TF6 vacuum contactors are available with busbar connections.

##### Auxiliary and control circuits

The 3RT12 and 3TF6 contactors are available with screw terminals.

##### Motor protection

For protection against overload, 3RB2 electronic overload relays (see [page 7/114 onwards](#)) can be mounted on the 3RT12 vacuum contactors.



# Switching devices – Contactors and contactor assemblies – for switching motors

## Power contactors for switching motors

### SIRIUS 3RT12 and 3TF6 vacuum contactors

#### Electromagnetic compatibility (EMC)

The contactors satisfy the conditions for environment A according to IEC 60947-1.

#### Contact reliability of the auxiliary contacts

If voltages  $\leq 110$  V and currents  $\leq 100$  mA are to be switched, the auxiliary contacts of the vacuum contactors or 3RH contactor relays should be used as they guarantee a high level of contact reliability.

These auxiliary contacts are particularly suitable for solid-state circuits with currents  $\geq 1$  mA at a voltage  $\geq 17$  V.

#### Vacuum interrupters

##### 3RT12 vacuum contactors

The contact gaps of the vacuum contactors are contained in hermetically enclosed vacuum interrupters unlike the 3RT10 contactors – the main contacts operate in air under atmospheric conditions. The particular benefit of vacuum contactors, however, is that their electrical endurance is significantly higher.

They are especially suited to frequent switching in inching/mixed operation, e.g. in crane control systems.

##### 3TF6 vacuum contactors

The switching contacts of the vacuum contactors are contained in hermetically enclosed vacuum interrupters.

With these contactors, the contact erosion of the vacuum interrupters can be checked in the energized state with the help of three white double slides below the connecting bars on the outgoing side.

#### Operating mechanism types

##### 3RT12 vacuum contactors

The contactors can be operated with AC (50 to 60 Hz) as well as with DC.

Two types of solenoid operation are available:

- Standard operating mechanism for AC and DC operation (power consumption reduced from closing to closed), version 3RT12...**A**
- Solid-state operating mechanism, version 3RT12...**N**

##### 3TF6 vacuum contactors

- Standard version 3TF6.44-**C.7** with AC operation
- Version 3TF6.33-**Q.7** for AC control supply voltage subject to strong interference:  
Contactors in this version are more robust against EMC interference and are therefore designed for operation in systems with AC control supply voltage that is subject to strong interference. A 3TC44 (3TY7684-0Q..) reversing contactor with a series resistor fitted is used to switch over to holding control. The reversing contactor can be mounted separately. It is connected to the 3TF6 main contactor by means of a pre-assembled connecting cable (approx. 1 m long) with plug-in connectors.  
This version is recommended in the environment of frequency converters and in the case of unshielded control cables.
- 3TF6.33-**D.4** contactors with DC control are supplied with a 3TC4417-4A.. reversing contactor and a series resistor.

#### Replacing operating mechanisms

##### 3RT12 vacuum contactors

The operating mechanisms of the vacuum contactors are removable and can be replaced simply by unlocking and pulling them out.

##### 3TF6 vacuum contactors

It is also possible to replace the drive components of the vacuum contactor.

#### Fitting auxiliary contacts and mounting additional auxiliary switches

##### Features in the delivery state

- 3RT12 vacuum contactors:  
These contactors are supplied with two laterally mounted auxiliary switches with two contacts each (2 NO + 2 NC)
- 3TF6 vacuum contactors:  
These contactors are supplied with four laterally mounted auxiliary switches with two contacts each (4 NO + 4 NC). For operating mechanism versions with 3TC (3 NO + 3 NC) series contactor, two auxiliary contacts are already defined.

##### Expansion possibilities

- 3RT12 vacuum contactors:  
All basic devices can be expanded via auxiliary switches. The permitted configuration must be taken into account.
- Vacuum contactor 3TF6:  
These devices are already fully equipped and no expansion is possible.

# Switching devices – Contactors and contactor assemblies – for switching motors

## Power contactors for switching motors

### SIRIUS 3RT12 and 3TF6 vacuum contactors

#### Technical specifications

Unless otherwise listed on subsequent pages, the technical specifications of the SIRIUS 3RT12 vacuum contactors correspond to those of the 3RT10 basic units; see pages 3/25, and 3/41 to 3/46.

#### More information

Technical specifications, see <https://support.industry.siemens.com/cs/ww/en/ps/16137/td>  
 FAQs, see <https://support.industry.siemens.com/cs/ww/en/ps/16137/faq>  
 System Manual for modular system, see <https://support.industry.siemens.com/cs/ww/en/view/60311318>  
 Equipment Manual, see <https://support.industry.siemens.com/cs/ww/en/view/60306557>  
 Application Manual - Switching devices with IE3 and IE4 motors, see <https://support.industry.siemens.com/cs/ww/en/view/94770820>  
 Configuration Manual for load feeders, see <https://support.industry.siemens.com/cs/ww/en/view/39714188>  
 Configuration Manual for UL, see <https://support.industry.siemens.com/cs/ww/en/view/53433538>  
 Guide of use for contactors in safety applications, see <https://support.industry.siemens.com/cs/ww/en/view/109807687>

Type  
Size

**SIRIUS vacuum contactors**  
**3RT12**  
**S10 and S12**

#### Contact endurance of the main contacts

The characteristic curves show the contact endurance of the contactors when switching low inductive or non-inductive AC loads (AC-1) and motor-driven loads (AC-3 and AC-3e) depending on the breaking current and rated operational voltage. It is assumed that the operating mechanisms are switched arbitrarily and not synchronously with the phase angle of the supply system switching operating mechanism.

The rated operational current  $I_e$  complies with utilization category AC-4 (breaking 6 times the rated operational current) and is intended for a contact endurance of approximately 200 000 operating cycles.

If a shorter contact endurance is sufficient, the rated operational current  $I_e/AC-4$  can be increased.

If the contacts are used for mixed operation, i.e. normal switching (breaking the rated operational current according to utilization category AC-3 and AC-3e) in combination with intermittent inching (breaking several times the rated operational current according to utilization category AC-4), the contact endurance can be calculated approximately from the following equation:

$$X = \frac{A}{1 + \frac{C}{100} \left( \frac{A}{B} - 1 \right)}$$

Characters in the equation:

- X Contact endurance for mixed operation in operating cycles
- A Contact endurance for normal operation ( $I_a = I_e$ ) in operating cycles
- B Contact endurance for inching ( $I_a = \text{multiple of } I_e$ ) in operating cycles
- C Inching operations as a percentage of total switching operations

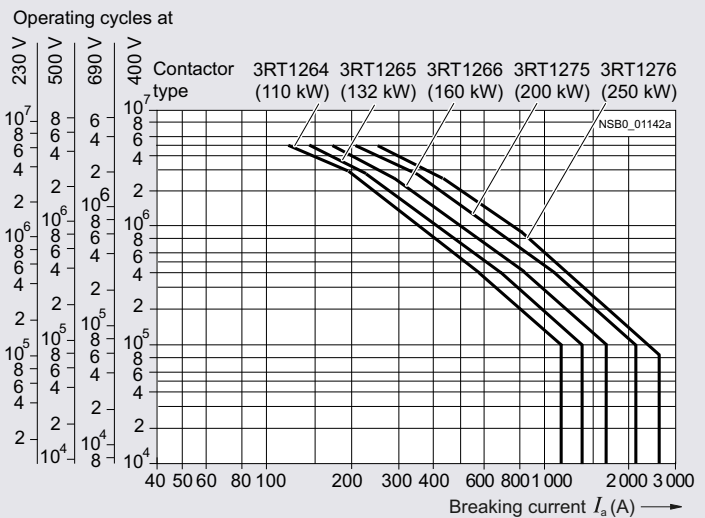

# Switching devices – Contactors and contactor assemblies – for switching motors

## Power contactors for switching motors

### SIRIUS 3RT12 and 3TF6 vacuum contactors

Type	Vacuum contactors				
Size	3TF6				
14					
<b>Rated data of the auxiliary contacts</b>					
According to IEC 60947-5-1					
<b>Rated insulation voltage <math>U_i</math></b> (pollution degree 3)	V	690			
<b>Conventional thermal current <math>I_{th}</math> = rated operational current <math>I_e/AC-12</math></b>	A	10			
<b>AC load</b>					
<b>Rated operational current <math>I_e/AC-15/AC-14</math></b>					
• At rated operational voltage $U_e$					
- At 24 V	A	10			
- At 110 V	A	10			
- At 125 V	A	10			
- At 220 V	A	6			
- At 230 V	A	5.6			
- At 380 V	A	4			
- At 400 V	A	3.6			
- At 500 V	A	2.5			
- At 660 V	A	2.5			
- At 690 V	A	2.3			
<b>DC load</b>					
<b>Rated operational current <math>I_e/DC-12</math></b>					
• At rated operational voltage $U_e$					
- At 24 V	A	10	10	10	
- At 60 V	A	10	10	10	
- At 110 V	A	3.2	3.2	3.2	
- At 125 V	A	2.5	2.5	2.5	
- At 220 V	A	0.9	0.9	0.9	
- At 440 V	A	0.33	0.33	0.33	
- At 600 V	A	0.22	0.22	0.22	
<b>Rated operational current <math>I_e/DC-13</math></b>					
• At rated operational voltage $U_e$					
- At 24 V	A	10			Auxiliary contacts with delayed NC contact: N S = No specification
- At 60 V	A	5			6
- At 110 V	A	1.14			N S
- At 125 V	A	0.98			0.98
- At 220 V	A	0.48			N S
- At 440 V	A	0.13			N S
- At 600 V	A	0.07			0.07
<b>Ⓢ and Ⓣ rated data of the auxiliary contacts</b>					
<b>Rated voltage, max.</b>	V AC	600			
<b>Switching capacity</b>	A 600, P 600				

# Switching devices – Contactors and contactor assemblies – for switching motors

## Power contactors for switching motors

### SIRIUS 3RT12 and 3TF6 vacuum contactors

Type  
Size

**Vacuum contactors**  
**3TF6**  
**14**

#### Electrical endurance of auxiliary contacts

The electrical endurance for utilization category AC-12 or AC-15/AC-14 depends mainly on the breaking current. It is assumed that the operating mechanisms are switched arbitrarily and not synchronously with the phase angle of the supply system switching operating mechanism.

The characteristic curves apply to 230 V AC.

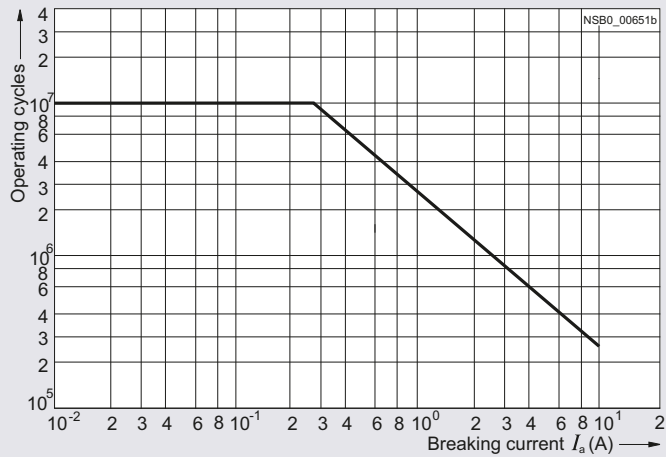

#### Contact endurance of the main contacts

The characteristic curves show the contact endurance of the contactors when switching low inductive or non-inductive AC loads (AC-1) and motor-driven loads (AC-3 and AC-3e) depending on the breaking current and rated operational voltage. It is assumed that the operating mechanisms are switched arbitrarily and not synchronously with the phase angle of the supply system switching operating mechanism.

The rated operational current  $I_e$  complies with utilization category AC-4 (breaking 6 times the rated operational current) and is intended for a contact endurance of approximately 200 000 operating cycles.

If a shorter contact endurance is sufficient, the rated operational current  $I_e/AC-4$  can be increased.

If the contacts are used for mixed operation, i.e. normal switching (breaking the rated operational current according to utilization category AC-3 and AC-3e) in combination with intermittent inching (breaking several times the rated operational current according to utilization category AC-4), the contact endurance can be calculated approximately from the following equation:

$$X = \frac{A}{1 + \frac{C}{100} \left( \frac{A}{B} - 1 \right)}$$

Characters in the equation:

- X Contact endurance for mixed operation in operating cycles
- A Contact endurance for normal operation ( $I_a = I_e$ ) in operating cycles
- B Contact endurance for inching ( $I_a = \text{multiple of } I_e$ ) in operating cycles
- C Inching operations as a percentage of total switching operations

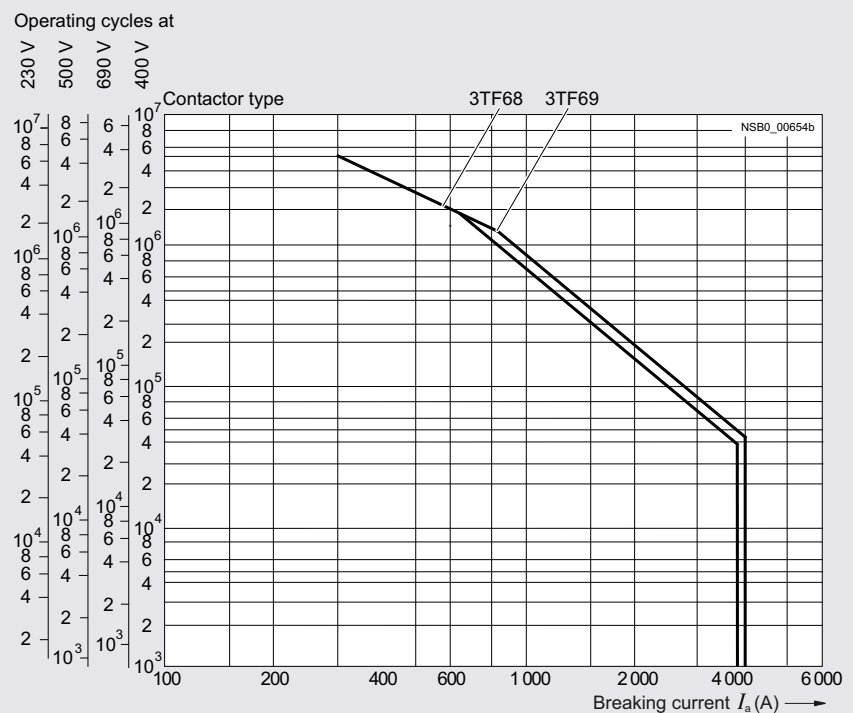

# Switching devices – Contactors and contactor assemblies – for switching motors

## Power contactors for switching motors

### SIRIUS 3RT12 and 3TF6 vacuum contactors

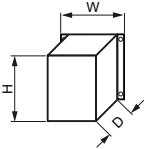
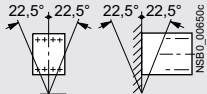
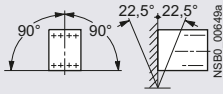
Type Size	SIRIUS vacuum contactors		Vacuum contactors			
	3RT126 S10	3RT127 S12	3TF68 14	3TF69		
<b>General data</b>						
<b>Dimensions (W x H x D)</b>		mm	145 x 210 x 206	160 x 214 x 225	230 x 276 x 237	230 x 295 x 237
<b>Permissible mounting position</b>	The contactors are designed for operation on a vertical mounting surface.					
<ul style="list-style-type: none"> <li>To easily replace the laterally mounted auxiliary switches it is recommended to maintain a minimum clearance of 30 mm between the contactors.</li> <li>If mounted at a 90° angle (conducting paths are horizontally above each other), the switching frequency is reduced to 80% compared with the normal values.</li> </ul>	No	No	Yes	Yes		
<b>Mechanical endurance</b>	Operating cycles	10 million	5 million			
<b>Electrical endurance</b>	Contact endurance of the main contacts	See page 3/122		See page 3/124		
<b>Rated insulation voltage <math>U_i</math></b> (pollution degree 3)	kV	1				
<b>Rated impulse withstand voltage <math>U_{imp}</math></b>	kV	8				
<b>Protective separation</b> between the coil and the main contacts according to IEC 60947-1, Annex N	V	690		1 000		
<b>Mirror contacts</b>	A mirror contact is an auxiliary NC contact that cannot be closed simultaneously with an NO main contact.		Yes, according to IEC 60947-4-1, Annex F		Yes, according to IEC 60947-4-1, Annex F One NC contact each must be connected in series for the left and right auxiliary switch respectively.	
<b>Permissible ambient temperature</b>	°C	-25 ... +60		-25 ... +55 <sup>1)</sup>		
• During storage	°C	-55 ... +80		-55 ... +80		
<b>Electromagnetic compatibility (EMC)</b>	See page 3/121					
<b>Short-circuit protection</b>						
<b>Main circuit</b>						
Fuse links, operational class gG: LV HRC, type 3NA; DIAZED, type 5SB; NEOZED, type 5SE according to IEC 60947-4-1						
• Type of coordination "1"	A	500	800	1 000	1 250	
• Type of coordination "2"	A	500	800	500	630	
• Weld-free (test conditions according to IEC 60947-4-1)	A	400	500	400	500	
<b>Auxiliary circuit</b>						
Short-circuit test						
• Fuse links, operational class gG: DIAZED, type 5SB; NEOZED, type 5SE (weld-free protection at $I_k \leq 1$ kA)	A	10				
• Miniature circuit breaker with C characteristic (short-circuit current $I_k \leq 400$ A)	A	10				
Short-circuit protection for contactors with overload relays		See Configuration Manual for load feeders				

<sup>1)</sup> For ambient temperatures > 55 °C, only 3TF6.33-.Q..-Z A02 contactors (= without connection of the main conducting paths) can be used. However, derating must be taken into account for these contactors too:  
- AC-1:  $I_e = 782$  A, 644 operating cycles/h;  
- AC-3/AC-3e: Operating range 0.85 to 1.05 x  $U_n$ , 460 operating cycles/h, mech. service life 5 million operating cycles, lateral clearance 10 mm.

# Switching devices – Contactors and contactor assemblies – for switching motors

## Power contactors for switching motors

### SIRIUS 3RT12 and 3TF6 vacuum contactors

			SIRIUS vacuum contactors		Vacuum contactors	
Type			3RT126	3RT127	3TF68	3TF69
Size			S10	S12	14	
Control						
Solenoid coil operating range			AC/DC	$0.8 \times U_{s \text{ min}} \dots 1.1 \times U_{s \text{ max}}$		$0.8 \times U_{s \text{ min}} \dots 1.1 \times U_{s \text{ max}}$
Power consumption of the solenoid coils (for cold coil and $1.0 \times U_s$ )						
<ul style="list-style-type: none"> <li>Standard operating mechanism (3RT10...-A)</li> </ul>						
- AC operation	Closing at $U_{s \text{ min}}/U_{s \text{ max}}$ P.f.	VA	530/630 0.9	700/830	--	--
	Closed at $U_{s \text{ min}}/U_{s \text{ max}}$ P.f.	VA	6.1/7.4 0.9	7.6/9.2	--	--
- DC operation	Closing at $U_{s \text{ min}}/U_{s \text{ max}}$ P.f.	W	580/780 6.8/8.2	770/920 8.5/10	--	--
<ul style="list-style-type: none"> <li>Solid-state operating mechanism (3RT10...-N/-P)</li> </ul>						
- AC operation	Closing at $U_{s \text{ min}}/U_{s \text{ max}}$ P.f.	VA	420/570 0.8	560/750	--	--
	Closed at $U_{s \text{ min}}/U_{s \text{ max}}$ P.f.	VA	5.5/8.5 0.5/0.4	5.6/9	--	--
- DC operation	Closing at $U_{s \text{ min}}/U_{s \text{ max}}$ P.f.	W	460/630 2.8/3.4	600/800 3/3.6	--	--
<ul style="list-style-type: none"> <li>Solid-state operating mechanism (3TF6...-C)</li> </ul>						
- AC operation	Closing at $U_{s \text{ min}}/U_{s \text{ max}}$ P.f.	VA	--	--	1 200/1 850 1	600/950 0.98
	Closed at $U_{s \text{ min}}/U_{s \text{ max}}$ P.f.	VA	--	--	13.5/49 0.15	12.9/30.6 0.31
- AC operation	Closing at $U_{s \text{ min}}$ P.f.	VA	--	--	1 000 0.99	1 150
	Closed at $U_{s \text{ min}}$ P.f.	VA	--	--	11 1	
- DC operation <sup>1)</sup>	Closing at $U_{s \text{ min}}$ P.f.	W	--	--	1 010 28	960 20.6
	Closed at $U_{s \text{ min}}$	W	--	--		
PLC control input according to IEC 61131-2			Type 2		--	
• Rated voltage		V DC	24		--	
• Operating range		V DC	17 ... 30		--	
• Power consumption		mA	≤ 30		--	
Minimum command duration					120	--
	Standard	ms	--		90	--
	Reduced make-time	ms	--			--
For closing						
Minimum interval time between two ON commands			ms	--	100	300

<sup>1)</sup> At 24 V DC; for further voltages, deviations of up to ± 10% are possible.

# Switching devices – Contactors and contactor assemblies – for switching motors

## Power contactors for switching motors

### SIRIUS 3RT12 and 3TF6 vacuum contactors

Type Size	SIRIUS vacuum contactors					Vacuum contactors			
	3RT1264 S10	3RT1265	3RT1266	3RT1275 S12	3RT1276	3TF68 14	3TF69		
<b>Rated data of the main contacts</b>									
<b>Load rating with AC</b>									
<b>Utilization category AC-3 and AC-3e</b>									
• Rated operational currents $I_e$	- Up to 690 V	A	225	265	300	400	500	630	820 (630) <sup>1)</sup>
	- Up to 1 000 V	A	225	265	300	400	500	435	580
• Rated power for slip-ring or squirrel-cage motors at 50 and 60 Hz	- At 230 V	kW	55	75	90	132	160	200	260 (200) <sup>1)</sup>
	- At 400 V	kW	110	132	160	200	250	335	450 (335) <sup>1)</sup>
	- At 500 V	kW	160	160	200	250	335	--	--
	- At 690 V	kW	200	250	250	400	500	600	800 (600) <sup>1)</sup>
	- At 1 000 V	kW	315	355	400	560	710	600	800
<b>Thermal load capacity, 10 s current</b>		A	1 800	2 120	2 400	3 200	4 000	5 040	7 000
<b>Power loss per main conducting path at <math>I_e/AC-3/AC-3e/400 V</math></b>		W	9	12	14	21	32	45	70
<b>Utilization category AC-4 (at <math>I_a = 6 \times I_e</math>)</b>									
Maximum values:									
• Rated operational current $I_e$	- Up to 690 V	A	195	230	280	350	430	610	690
• Rated power for squirrel-cage motors at 50 Hz and 60 Hz	- At 400 V	kW	110	132	160	200	250	355	400
The following applies to a contact endurance of about 200 000 operating cycles:									
• Rated operational currents $I_e$	- Up to 690 V	A	97	115	140	175	215	300	360
	- Up to 1 000 V	A	68	81	98	123	151	210	250
• Rated power for squirrel-cage motors at 50 Hz and 60 Hz	- At 230 V	kW	30	37	45	56	70	97	110
	- At 400 V	kW	55	65	79	98	122	168	191
	- At 500 V	kW	68	81	98	124	153	210 <sup>2)</sup>	250 <sup>2)</sup>
	- At 690 V	kW	94	112	138	172	212	278 <sup>2)</sup>	335 <sup>2)</sup>
	- At 1 000 V	kW	95	114	140	183	217	290 <sup>2)</sup>	350 <sup>2)</sup>





<sup>1)</sup> Value applies for utilization category AC-3e.

<sup>2)</sup> Max. permissible rated operational current  $I_e/AC-4 = I_e/AC-3/AC-3e$  up to 500 V, for reduced contact endurance and reduced switching frequency.

# Switching devices – Contactors and contactor assemblies – for switching motors

## Power contactors for switching motors

### SIRIUS 3RT12 and 3TF6 vacuum contactors

Type Size	SIRIUS vacuum contactors		Vacuum contactors	
	3RT126 S10	3RT127 S12	3TF68 14	3TF69
<b>Conductor cross-sections</b>				
<b>Main conductors</b> (1 or 2 conductors can be connected)				
 <b>Screw terminals</b>				
With mounted box terminals	Type	3RT1966-4G		--
• Terminal screws - Tightening torque	Nm	M12 (hexagon socket, A/F 5) 20 ... 22 (180 ... 195 lb.in)		--
Front clamping point connected				
	• Finely stranded with end sleeve (DIN 46228)	mm <sup>2</sup>	70 ... 240	--
	• Finely stranded without end sleeve	mm <sup>2</sup>	70 ... 240	--
	• Stranded	mm <sup>2</sup>	95 ... 300	--
	• AWG cables, solid or stranded	AWG	3/0 ... 600 kcmil	--
• Ribbon cable conductors (number x width x thickness)	mm	Min. 6 x 9 x 0.8; max. 20 x 24 x 0.5		--
Rear clamping point connected				
	• Finely stranded with end sleeve (DIN 46228)	mm <sup>2</sup>	120 ... 185	--
	• Finely stranded without end sleeve	mm <sup>2</sup>	120 ... 185	--
	• Stranded	mm <sup>2</sup>	120 ... 240	--
	• AWG cables, solid or stranded	AWG	250 ... 500 kcmil	--
• Ribbon cable conductors (number x width x thickness)	mm	Min. 6 x 9 x 0.8; max. 20 x 24 x 0.5		--
Both clamping points connected				
	• Finely stranded with end sleeve (DIN 46228)	mm <sup>2</sup>	Min. 2 x 50, max. 2 x 185	--
	• Finely stranded without end sleeve	mm <sup>2</sup>	Min. 2 x 50, max. 2 x 185	--
	• Stranded	mm <sup>2</sup>	Min. 2 x 70, max. 2 x 240	--
	• AWG cables, solid or stranded	AWG	Min. 2 x 2/0, max. 1 x 500 kcmil	--
• Ribbon cable conductors (number x width x thickness)	mm	Max. 2 x (20 x 24 x 0.5)		--
Cable lug connection				
• Finely stranded with cable lug <sup>1)</sup>	mm <sup>2</sup>	50 ... 240		--
• Stranded with cable lug <sup>1)</sup>	mm <sup>2</sup>	70 ... 240		--
• AWG cables, solid or stranded	AWG	2/0 ... 500 kcmil		--
• Terminal screws - Tightening torque	Nm	M10 x 30 (A/F 17) 14 ... 24 (124 ... 210 lb.in)		--
Busbar connections				
• Finely stranded with cable lug	mm <sup>2</sup>	--	50 ... 240	
• Stranded with cable lug	mm <sup>2</sup>	--	70 ... 240	50 ... 240
• Solid or stranded	AWG	--	2/0 ... 500 MCM	2/0 ... 500 MCM
• Connecting bar (max. width)	mm	25	50	60 (U <sub>b</sub> ≤ 690 V), 50 (U <sub>b</sub> > 690 V)
• Terminal screws - Tightening torque	Nm lb.in	-- --	M10 x 30 14 ... 24 124 ... 210	M12 x 40 20 ... 35 177 ... 310
With box terminal (see page 3/134)				
• Connectable laminated copper bars		--	Yes	
• Width	mm	--	15 ... 25	15 ... 38
• Max. thickness	mm	--	1 x 26 or 2 x 11	1 x 46 or 2 x 18
• Terminal screw		--	A/F 6 (hexagon socket)	A/F 8 (hexagon socket)
• Tightening torque	Nm	--	25 ... 40 (221 ... 354 lb.in)	35 ... 50 (266 ... 443 lb.in)
<b>Auxiliary conductors</b> (1 or 2 conductors can be connected)				
• Solid	mm <sup>2</sup>	2 x (0.5 ... 1.5) <sup>2)</sup> ; 2 x (0.75 ... 2.5) <sup>2)</sup> according to IEC 60947; max. 2 x (0.75 ... 4)		2 x (0.5 ... 1) <sup>2)</sup> /2 x (1 ... 2.5) <sup>2)</sup>
• Finely stranded with end sleeve (DIN 46228)	mm <sup>2</sup>	2 x (0.5 ... 1.5) <sup>2)</sup> ; 2 x (0.75 ... 2.5) <sup>2)</sup>		2 x (0.5 ... 1) <sup>2)</sup> ; 2 x (0.75 ... 2.5) <sup>2)</sup>
• Pin cable lug according to DIN 46231	mm <sup>2</sup>	--		2 x (1 ... 1.5)
• AWG cables, solid or stranded	AWG	2 x (18 ... 14)		2 x (18 ... 12)
• Terminal screws - Tightening torque	Nm	M3 (Pozidriv size 2) 0.8 ... 1.2 (7 ... 10.3 lb.in)		-- 0.8 ... 1.4 (7 ... 12 lb.in)

<sup>1)</sup> When connecting cable lugs according to DIN 46234 for conductor cross-sections larger than 240 mm<sup>2</sup> and according to DIN 46235 for conductor cross-sections larger than 185 mm<sup>2</sup>, the 3RT1966-4EA1 terminal cover is required to maintain the phase clearance, see page 3/112.

<sup>2)</sup> If two different conductor cross-sections are connected to one clamping point, both cross-sections must lie in one of the ranges specified.



# Switching devices – Contactors and contactor assemblies – for switching motors

## Power contactors for switching motors

### SIRIUS 3RT12 and 3TF6 vacuum contactors

Type Size	SIRIUS vacuum contactors					Vacuum contactors		
	3RT1264 S10	3RT1265	3RT1266	3RT1275 S12	3RT1276	3TF68 14	3TF69	
<b>Ⓢ and Ⓤ rated data</b>								
<b>Rated insulation voltage</b>	V AC	600					600	
<b>Uninterrupted current</b> at 40 °C, open and enclosed	A	330			540		630	820
<b>Maximum horsepower ratings</b> (from Ⓢ and Ⓤ approved values)								
• Rated power for three-phase motors at 60 Hz								
- At 200 V	hp	60	75	100	125	150	231	290
- At 230 V	hp	75	100	125	150	200	266	350
- At 460 V	hp	150	200	250	300	400	530	700
- At 575 V	hp	200	250	300	400	500	664	860
<b>NEMA/EEMAC ratings</b>								
SIZE	hp	--					6	7
• Uninterrupted current								
- Open	A	--					600	820
- Enclosed	A	--					540	810
• Rated power for three-phase motors at 60 Hz								
- At 200 V	hp	--					150	--
- At 230 V	hp	--					200	300
- At 460 V	hp	--					400	600
- At 575 V	hp	--					400	600
<b>Short-circuit protection<sup>1)</sup></b>								
	kA	10	18			30	100	
• CLASS L fuse	A	600	700	800	1 000	1 200	1 600	
• Circuit breakers according to UL 489	A	500	700	800	1 000	1 200	On request <sup>1)</sup>	

<sup>1)</sup> For more information about short-circuit values, e.g. for protection against high short-circuit currents, see [Certificate of Compliance for the individual devices](#).

For the selection and dimensioning of load feeders, see [Configuration Manual for UL and the UL guide "Competitive control panels for the North American market"](#).

# Switching devices – Contactors and contactor assemblies – for switching motors

## Power contactors for switching motors

SIRIUS 3RT12 and 3TF6 vacuum contactors **IE3/IE4 ready** **AC-3e**

### Selection and ordering data

#### SIRIUS 3RT12 vacuum contactors, 3-pole, 110 to 250 kW

AC/DC operation 

- Standard operating mechanism 3RT12...-A
- 3RT12...-N solid-state operating mechanism with 24 V DC control signal input
- For screw fixing
- Auxiliary and control conductors: Screw terminals
- Main conductors: Busbar connections; a connection kit with screws, spring washers and nuts is enclosed.



3RT1264-6AF36



3RT127...-6N.36

Size	Rated data					AC-1, $t_{ij}$ : 40 °C	Auxiliary contacts, lateral		Rated control supply voltage $U_s$ 50/60 Hz AC or DC	Screw terminals 	PU (UNIT, SET, M)	PS*	PG
	AC-3 and AC-3e, $t_{ij}$ : up to 60 °C	Rating of three-phase motors at 50 Hz and					Operational current $I_e$ up to	NO					
	Operational current $I_e$ up to	230 V	400 V	500 V	690 V	1 000 V							
	A	kW	kW	kW	kW	A							
<b>Standard operating mechanism for AC and DC operation (power consumption reduced from closing to closed)</b>													
<b>With integrated coil circuit (varistor integrated at the factory)</b>													
<b>S10</b>	225	55	<b>110</b>	160	200	330	2	2	110 ... 127 220 ... 240	<b>3RT1264-6AF36</b> <b>3RT1264-6AP36</b>	1	1 unit	41B
	265	75	<b>132</b>	160	250	330	2	2	110 ... 127 220 ... 240	<b>3RT1265-6AF36</b> <b>3RT1265-6AP36</b>	1	1 unit	41B
	300	90	<b>160</b>	200	250	330	2	2	110 ... 127 220 ... 240	<b>3RT1266-6AF36</b> <b>3RT1266-6AP36</b>	1	1 unit	41B
<b>S12</b>	400	132	<b>200</b>	250	400	610	2	2	110 ... 127 220 ... 240	<b>3RT1275-6AF36</b> <b>3RT1275-6AP36</b>	1	1 unit	41B
	500	160	<b>250</b>	355	500	610	2	2	110 ... 127 220 ... 240	<b>3RT1276-6AF36</b> <b>3RT1276-6AP36</b>	1	1 unit	41B
<b>Solid-state operating mechanism</b>													
<b>With 24 V DC control signal input e.g. for control by PLC</b>													
<b>With integrated coil circuit (varistor integrated in electronics at the factory)</b>													
<b>S10</b>	225	55	<b>110</b>	160	200	330	2	2	96 ... 127 200 ... 277	<b>3RT1264-6NF36</b> <b>3RT1264-6NP36</b>	1	1 unit	41B
	265	75	<b>132</b>	160	250	330	2	2	96 ... 127 200 ... 277	<b>3RT1265-6NF36</b> <b>3RT1265-6NP36</b>	1	1 unit	41B
	300	90	<b>160</b>	200	250	330	2	2	96 ... 127 200 ... 277	<b>3RT1266-6NF36</b> <b>3RT1266-6NP36</b>	1	1 unit	41B
<b>S12</b>	400	132	<b>200</b>	250	400	610	2	2	96 ... 127 200 ... 277	<b>3RT1275-6NF36</b> <b>3RT1275-6NP36</b>	1	1 unit	41B
	500	160	<b>250</b>	355	500	610	2	2	96 ... 127 200 ... 277	<b>3RT1276-6NF36</b> <b>3RT1276-6NP36</b>	1	1 unit	41B

Other voltages [according to page 3/68](#) on request.

For an overview of the 3RT12 vacuum contactors with mountable accessories, [see pages 3/14 and 3/16](#).

The accessories for the 3RT1 vacuum contactors correspond to those for the basic units of the 3RT1 contactors, [see page 3/69 onwards](#).

For spare parts, [see page 3/136](#).

# Switching devices – Contactors and contactor assemblies – for switching motors

## Power contactors for switching motors

AC-3e

IE3/IE4 ready

SIRIUS 3RT12 and 3TF6 vacuum contactors

### 3TF6 vacuum contactors, 3-pole, 335 to 450 kW

#### AC operation

- For screw fixing
- Main conductors: Busbar connections
- Auxiliary and control conductors: Screw terminals
- With overvoltage protection of the coil (varistor)



3TF68



3TF69

Size	Rated data	Operational current $I_e$ up to	Rating of three-phase motors at 50 Hz and	AC-1, $t_j$ : 40 °C	Operational current $I_e$ up to	Auxiliary contacts, lateral	Rated control supply voltage $U_s$	50/60 Hz AC	Screw terminals 	PU (UNIT, SET, M)	PS*	PG		
	AC-3 and AC-3e, $t_j$ : up to 55 °C	690 V	230 V	400 V	690 V	1 000 V	NO	NC	Article No.	Price per PU				
		A	kW	kW	kW	kW		V						
<b>AC operation 50/60 Hz<sup>1)</sup></b>														
<b>14</b>	630	200	<b>335</b>	600	--	700	4	4	110 ... 132 200 ... 240	<b>3TF6844-0CF7</b> <b>3TF6844-0CM7</b>	1	1 unit	41B	
						600	700	4	4	110 ... 132 200 ... 240	<b>3TF6844-8CF7</b> <b>3TF6844-8CM7</b>	1	1 unit	41B
<b>14</b>	820 (630) <sup>2)</sup>	260 (200) <sup>2)</sup>	<b>450</b> <b>(335)<sup>2)</sup></b>	800 (600) <sup>2)</sup>	--	910	4	4	110 ... 132 200 ... 240	<b>3TF6944-0CF7</b> <b>3TF6944-0CM7</b>	1	1 unit	41B	
						800	910	4	4	110 ... 132 200 ... 240	<b>3TF6944-8CF7</b> <b>3TF6944-8CM7</b>	1	1 unit	41B

<sup>1)</sup> Please observe the information regarding the use of 3TF6 vacuum contactors in the environment of frequency converters, see page 3/120.

<sup>2)</sup> Value applies for utilization category AC-3e.

For an overview of the 3TF6 vacuum contactors with mountable accessories, see page 3/17.

Accessories and spare parts, see pages 3/133 to 3/137.

#### Rated control supply voltages, possible on request (change of the 10th and 11th digits of the article number)

Delivery time on request

Rated control supply voltage $U_s$	Contactor type	3TF6844-C..., 3TF6944-C...
	Size	14

#### AC operation

##### Solenoid coils for 50/60 Hz

110 ... 132 V AC	F7
200 ... 240 V AC	M7
230 ... 277 V AC	P7
380 ... 460 V AC	Q7
500 ... 600 V AC	S7

# Switching devices – Contactors and contactor assemblies – for switching motors

## Power contactors for switching motors

SIRIUS 3RT12 and 3TF6 vacuum contactors **IE3/IE4 ready** **AC-3e**

DC operation  and for AC control supply voltage subject to strong interference 

- Main conductors: Busbar connections
- Auxiliary and control conductors: Screw terminals
- Power consumption reduced from closing to closed

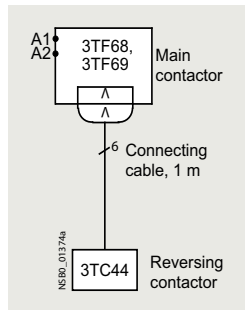

Circuit diagram for AC operation, 50/60 Hz, for AC control supply voltage subject to strong interference



3TF6833-1D.4 with reversing contactor 3TC4417-0A

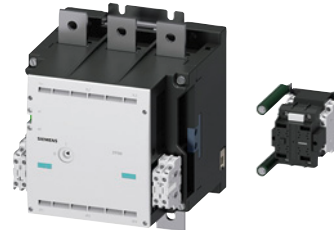

3TF6933-1Q.7 with reversing contactor 3TC4417-0B

Size	Rated data					AC-1, $t_{ij}$ : 40 °C	Auxiliary contacts, lateral		Rated control supply voltage $U_s$ 50/60 Hz AC or DC	Screw terminals 	PU (UNIT, SET, M)	PS*	PG	
	AC-3 and AC-3e, $t_{ij}$ : up to 55 °C	Operational current $I_e$ up to	Rating of three-phase motors at 50 Hz and				NO	NC						Article No.
A	kW	<b>kW</b>	kW	kW	A		V							
<b>DC operation<sup>1)</sup></b>														
<b>14</b>	630	200	<b>335</b>	600	--	700	3	3	24 DC	<b>3TF6833-1DB4</b>	1	1 unit	41B	
						600	700	3	3	24 DC		1	1 unit	41B
<b>14</b>	820 (630) <sup>2)</sup>	260 (200) <sup>2)</sup>	<b>450</b> (335) <sup>2)</sup>	800 (600) <sup>2)</sup>	--	910	3	3	24 DC	<b>3TF6933-1DB4</b>	1	1 unit	41B	
						800	910	3	3	24 DC		1	1 unit	41B
<b>AC operation 50/60 Hz<sup>1)3)</sup></b>														
<b>For AC control supply voltage subject to strong interference</b>														
<b>14</b>	630	200	<b>335</b>	600	--	700	3	3	110 ... 120 AC	<b>3TF6833-1QG7</b>	1	1 unit	41B	
									220 ... 240 AC	<b>3TF6833-1QL7</b>	1	1 unit	41B	
									380 ... 420 AC	<b>3TF6833-1QV7</b>	1	1 unit	41B	
						600	700	3	3	220 ... 240 AC	<b>3TF6833-8QL7</b>	1	1 unit	41B
<b>14</b>	820 (630) <sup>2)</sup>	260 (200) <sup>2)</sup>	<b>450</b> (335) <sup>2)</sup>	800 (600) <sup>2)</sup>	--	910	3	3	110 ... 120 AC	<b>3TF6933-1QG7</b>	1	1 unit	41B	
									220 ... 240 AC	<b>3TF6933-1QL7</b>	1	1 unit	41B	
									380 ... 420 AC	<b>3TF6933-1QV7</b>	1	1 unit	41B	
						800	910	3	3	110 ... 120 AC	<b>3TF6933-8QG7</b>	1	1 unit	41B
									220 ... 240 AC	<b>3TF6933-8QL7</b>	1	1 unit	41B	

<sup>1)</sup> Please observe the information regarding the use of 3TF6 vacuum contactors in the environment of frequency converters, see page 3/120.

<sup>2)</sup> Value applies for utilization category AC-3e.

<sup>3)</sup> A DC solenoid system with rectifier is used in this version. Varistor integrated. A 3TC4417-... reversing contactor with pre-assembled connecting cable (approx. 1 m) and plug-in connector is included in the scope of supply of the vacuum contactor.

For an overview of the 3TF6 vacuum contactors with mountable accessories, see page 3/17.

Accessories and spare parts, see pages 3/133 to 3/137.

### Rated control supply voltages, possible on request (change of the 10th and 11th digits of the article number)

Delivery time on request

Rated control supply voltage $U_s$	Contactor type	3TF6833-.D., 3TF6933-.D..	Size 14
<b>DC operation</b>			
<b>Solenoid coils</b>			
24 V DC			B4
110 V DC			F4
125 V DC			G4
220 V DC			M4
230 V DC			P4

# Switching devices – Contactors and contactor assemblies – for switching motors

## Power contactors for switching motors

### Accessories and spare parts for SIRIUS 3RT12 and 3TF6 vacuum contactors









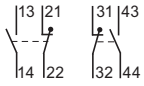

#### Selection and ordering data

##### Accessories

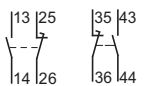
For further accessories for the SIRIUS 3RT12 vacuum contactors, see 3RT10 basic units, page 3/69 onwards.

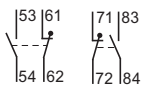
Overview graphics with mountable accessories:

- 3RT12 contactors, see pages 3/14 and 3/16
- 3TF68 and 3TF69 contactors, see page 3/17

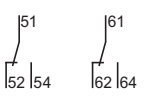
For contactors	Auxiliary contacts				Connections		Screw terminals 	PU (UNIT, SET, M)	PS*	PG
	Version	NO	NC	NC	Left	Right				
Size	Type	NO	NC	NC	Left	Right	Article No.	Price per PU		
<b>Auxiliary switches, instantaneous</b>										
<b>For lateral mounting</b>										
	14	3TF68, 3TF69	1	1	--		<b>3TY7561-1AA00</b>	1	1 unit	41B
		3TF68, 3TF69	1	--	1		<b>3TY7561-1EA00</b>	1	1 unit	41B
		3TF68, 3TF69	1	1	--		<b>3TY7561-1KA00</b>	1	1 unit	41B
	14	3TF68, 3TF69	--	--	1		<b>3TY7681-1G</b>	1	1 unit	41B
<b>Solid-state compatible auxiliary switches</b>										
<b>For lateral mounting</b>										
	14	3TF68, 3TF69	1	CO contact			<b>3TY7561-1UA00</b>	1	1 unit	41B

# Switching devices – Contactors and contactor assemblies – for switching motors

## Power contactors for switching motors







### Accessories and spare parts for SIRIUS 3RT12 and 3TF6 vacuum contactors

For contactors	Version	Article No.	Price per PU	PU (UNIT, SET, M)	PS*	PG	
Size	Type						
<b>Main conducting path surge suppression modules</b>							
 3RT1966-1PV3	S10/ S12	3RT12	For damping overvoltages and protecting motor windings against multiple re-ignition when switching off three-phase motors For connection on the outgoing contactor side (2-T1/4-T2/6-T3), for separate installation Rated operational voltage $U_s$				
			<ul style="list-style-type: none"> <li>• 690 V AC</li> <li>• 1 000 V AC</li> </ul>	<b>3RT1966-1PV3</b>	1	1 unit	41B
 3RT1966-1PV4				<b>3RT1966-1PV4</b>	1	1 unit	41B
<b>Box terminal blocks for connecting auxiliary conductors to main terminals</b>							
 3RT1966-4G	S10/ S12	3RT12	For round and ribbon cables Connectable cross-sections of the contactors, see <a href="#">Technical specifications, page 3/128</a> .				
			<ul style="list-style-type: none"> <li>• Up to 240 mm<sup>2</sup>, with auxiliary conductor connection up to 2.5 mm<sup>2</sup></li> </ul>	<b>3RT1966-4G</b>	1	1 unit	41B
<b>Surge suppressors</b>							
 3TX7572-3.	14	3TF68, 3TF69	<b>Varistors</b> <u>AC operation</u> The surge suppressor (varistor) is included in the scope of supply of the 3TF68 and 3TF69 contactors with AC operation. <u>DC operation</u> Varistor for snapping onto the side of the auxiliary switch (includes the peak value of the alternating voltage on the DC side), connection to A1 and A2 Rated control supply voltage $U_s$				
			<ul style="list-style-type: none"> <li>• 24 ... 48 V DC</li> <li>• 127 ... 240 V DC</li> </ul>	<b>3TX7572-3G</b>	1	1 unit	41B
				<b>3TX7572-3J</b>	1	1 unit	41B
<b>Terminal covers</b>							
 3TX76.6-0A	14	3TF68 3TF69	For protection against inadvertent contact, two units required per contactor (1 set = 2 units)	<b>3TX7686-0A</b>	1	1 unit	41B
				<b>3TX7696-0A</b>	1	1 unit	41B
 3TX7686-0B		3TF68	On the outgoing side combined with overload relay, for protection against inadvertent contact with exposed busbar connections	<b>3TX7686-0B</b>	1	1 unit	41B
<b>Links for paralleling (star jumpers), 3-pole</b>							
 3TX7680-0D	14	3TF68, 3TF69	without connecting terminal (the link for paralleling can be reduced by one pole)	<b>3TX7680-0D</b>	1	1 unit	41B
<b>Box terminals for laminated copper bars</b>							
 3TX7570-1E	14	3TF68	<b>Without auxiliary conductor connection</b> (1 set = 3 units) With single covers for protection against inadvertent contact (IEC 60529)	<b>3TX7570-1E</b>	1	1 unit	41B
 3TX7690-1F		3TF69	<b>With auxiliary conductor connection</b> (1 set = 3 units) Conductor cross-sections for auxiliary conductors: <ul style="list-style-type: none"> <li>• Solid 2 x (0.75 ... 2.5) mm<sup>2</sup></li> <li>• Finely stranded with end sleeve 2 x (0.5 ... 2.5) mm<sup>2</sup></li> <li>• AWG, solid or stranded 2 x (18 ... 12)</li> <li>• Tightening torque 0.8 ... 1.4 Nm (7 ... 12 lb.in)</li> </ul>	<b>3TX7690-1F</b>	1	1 unit	41B

# Switching devices – Contactors and contactor assemblies – for switching motors

## Power contactors for switching motors

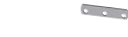
### Accessories and spare parts for SIRIUS 3RT12 and 3TF6 vacuum contactors

For contactors	Version		Article No.	Price per PU	PU (UNIT, SET, M)	PS*	PG
Size	Type						
<b>Locking devices for mechanical interlock</b>							
	14	3TF68-3TF68	For two contactors of the same size, for mounting on base plate	<b>3TX7686-1A</b>	1	1 unit	41B
<b>Base plates</b>							
<b>For reversing contactor assemblies</b>							
	14	3TF68-3TF68	For customer assembly of reversing contactor assemblies	<b>3TX7681-1A</b>	1	1 unit	41B
<b>For contactor assemblies for star-delta (wye-delta) starting</b>							
	14	3TF68-3TF68-3RT1.7	For configuring contactor assemblies for star-delta (wye-delta) starting	<b>3TX7681-1B</b>	1	1 unit	41B
<b>Assembly kits for contactor assemblies</b>							
<b>For reversing contactor assemblies</b>							
	14	3TF68-3TF68	The assembly kit contains: wiring modules on the top and bottom	<b>3TX7680-1A</b>	1	1 unit	41B
							
<b>For contactor assemblies for star-delta (wye-delta) starting</b>							
	14	3TF68-3TF68-3RT1.7	The assembly kit contains: Wiring modules on the top and bottom, Star jumper S12	<b>3TX7680-1B</b>	1	1 unit	41B
							





# Switching devices – Contactors and contactor assemblies – for switching motors

## Power contactors for switching motors

### Accessories and spare parts for SIRIUS 3RT12 and 3TF6 vacuum contactors

#### Spare parts

PU (UNIT, SET, M) = 1  
 PS\* = 1 unit  
 PG = 41B

For contactors		Rated control supply voltage $U_{s \text{ min}}$ to $U_{s \text{ max}}$	Screw terminals 	Spring-loaded terminals 				
Size	Type	V AC/DC	Article No.	Price per PU	Article No.	Price per PU		
<b>Withdrawable coils</b>								
<b>Standard operating mechanism for AC/DC</b>								
	S10	3RT126	23 ... 26	3RT1966-5AB31	--	--		
			42 ... 48	3RT1966-5AD31	--	--		
			110 ... 127	3RT1966-5AF31	--	--		
			200 ... 220	3RT1966-5AM31	--	--		
			220 ... 240	3RT1966-5AP31	--	--		
			240 ... 277	3RT1966-5AU31	--	--		
			380 ... 420	3RT1966-5AV31	--	--		
			440 ... 480	3RT1966-5AR31	--	--		
			500 ... 550	3RT1966-5AS31	--	--		
			575 ... 600	3RT1966-5AT31	--	--		
	S12	3RT127	23 ... 26	3RT1975-5AB31	3RT1975-5AB32	3RT1975-5AB32		
			42 ... 48	3RT1975-5AD31	3RT1975-5AD32	3RT1975-5AD32		
			110 ... 127	3RT1975-5AF31	3RT1975-5AF32	3RT1975-5AF32		
			200 ... 220	3RT1975-5AM31	3RT1975-5AM32	3RT1975-5AM32		
			220 ... 240	3RT1975-5AP31	3RT1975-5AP32	3RT1975-5AP32		
			240 ... 277	3RT1975-5AU31	3RT1975-5AU32	3RT1975-5AU32		
			380 ... 420	3RT1975-5AV31	3RT1975-5AV32	3RT1975-5AV32		
			440 ... 480	3RT1975-5AR31	3RT1975-5AR32	3RT1975-5AR32		
			500 ... 550	3RT1975-5AS31	3RT1975-5AS32	3RT1975-5AS32		
			575 ... 600	3RT1975-5AT31	3RT1975-5AT32	3RT1975-5AT32		
	S10	3RT126	21 ... 27.3	3RT1966-5NB31	--	--		
			96 ... 127	3RT1966-5NF31	--	--		
			200 ... 277	3RT1966-5NP31	--	--		
			S12	3RT127	21 ... 27.3	3RT1975-5NB31	3RT1975-5NB32	3RT1975-5NB32
					96 ... 127	3RT1975-5NF31	3RT1975-5NF32	3RT1975-5NF32
					200 ... 277	3RT1975-5NP31	3RT1975-5NP32	3RT1975-5NP32



# Switching devices – Contactors and contactor assemblies – for switching motors

## Power contactors for switching motors

### Accessories and spare parts for SIRIUS 3RT12 and 3TF6 vacuum contactors

For contactors		Version	Rated control supply voltage $U_s$	Article No.	Price per PU	PU (UNIT, SET, M)	PS*	PG
Size	Type		V					
<b>Solenoid coils</b>								
	14	3TF68	<b>AC operation</b>	50/60 Hz AC				
			The solenoid coils are fitted as standard with varistors against overvoltage; the coil is supplied with switch-on electronics.	110 ... 132	<b>3TY7683-OCF7</b>	1	1 unit	41B
				200 ... 240	<b>3TY7683-OCM7</b>	1	1 unit	41B
				230 ... 277	<b>3TY7683-OCP7</b>	1	1 unit	41B
				200 ... 240	<b>3TY7683-OCQ7</b>	1	1 unit	41B
				380 ... 460	<b>3TY7683-OCS7</b>	1	1 unit	41B
3TY76.3-OC..	3TF69	The solenoid coils are fitted as standard with varistors against overvoltage; the coil is supplied with switch-on electronics.	110 ... 132	<b>3TY7693-OCF7</b>	1	1 unit	41B	
			200 ... 240	<b>3TY7693-OCM7</b>	1	1 unit	41B	
			230 ... 277	<b>3TY7693-OCP7</b>	1	1 unit	41B	
			200 ... 240	<b>3TY7693-OCQ7</b>	1	1 unit	41B	
			380 ... 460	<b>3TY7693-OCS7</b>	1	1 unit	41B	
	14	3TF68	<b>DC operation</b>	24 DC	<b>3TY7683-0DB4</b>	1	1 unit	41B
			The solenoid coils are supplied without reversing contactor.	110 DC	<b>3TY7683-0DF4</b>	1	1 unit	41B
				125 DC	<b>3TY7683-0DG4</b>	1	1 unit	41B
				220 DC	<b>3TY7683-0DM4</b>	1	1 unit	41B
				230 DC	<b>3TY7683-0DP4</b>	1	1 unit	41B
<b>Vacuum interrupters</b>								
	S10	3RT1264 3RT1265 3RT1266	Set with three vacuum interrupters with fixing parts	--	<b>3RT1964-6V</b>	1	1 unit	41B
				--	<b>3RT1965-6V</b>	1	1 unit	41B
				--	<b>3RT1966-6V</b>	1	1 unit	41B
3RT197..-6V	S12	3RT1275 3RT1276	Set with three vacuum interrupters with components	--	<b>3RT1975-6V</b>	1	1 unit	41B
				--	<b>3RT1976-6V</b>	1	1 unit	41B
	14	3TF68 3TF69	Set with three vacuum interrupters with components	--	<b>3TY7680-0B</b>	1	1 unit	41B
				--	<b>3TY7690-0B</b>	1	1 unit	41B
		<b>Note:</b>		In order to ensure reliable operation of the contactors, only <b>original replacement interrupters</b> should be used.				
<b>Solenoid coils for main contactors</b>								
For contactors		Version	Rated control supply voltage $U_s$	Article No.	Price per PU	PU (UNIT, SET, M)	PS*	PG
Size	Type		50/60 Hz AC					
			V					
14	3TF68..-Q	With rectifier bridge	220 ... 240	<b>3TY7683-0QL7</b>		1	1 unit	41B
14	3TF69..-Q	With rectifier bridge	110 ... 120	<b>3TY7693-0QG7</b>		1	1 unit	41B
			220 ... 240	<b>3TY7693-0QL7</b>		1	1 unit	41B
<b>3TC44 reversing contactors</b>								
	14	3TF68..-Q, 3TF69..-Q	Complete with series resistor, 1 m connecting cable and plug-in connector	110 ... 120	<b>3TY7684-0QG7</b>	1	1 unit	41B
				220 ... 240	<b>3TY7684-0QL7</b>	1	1 unit	41B
				380 ... 420	<b>3TY7684-0QV7</b>	1	1 unit	41B
<b>AC solenoid operating mechanism with coil</b>								
	14	3TF6844..C	Solenoid operating mechanism with coil	200 ... 240	<b>3TY7685-0CM7</b>	1	1 unit	41B
				230 ... 276	<b>3TY7685-0CP7</b>	1	1 unit	41B
				380 ... 420	<b>3TY7685-0CS7</b>	1	1 unit	41B
3TY7685-0C.7								

# Switching devices – Contactors and contactor assemblies – for switching motors

## Power contactors for switching motors

### 3TG10 power relays/miniature contactors

#### Overview

##### Standards

IEC 60947-1, IEC 60947-4-1, IEC 60947-5-1

##### Version

The 3TG10 power relays/miniature contactors are available with screw terminals or 6.3 mm x 0.8 mm flat connectors.

The 3TG10 miniature contactors are characterized by their width of just 36 mm.

##### Protection of the device connections from overvoltage

The 3TG10 power relays/miniature contactors have an integrated protective circuit against switching overvoltages.

#### Application

Because they are hum-free they are suitable for use in household appliances and distribution boards in office and residential areas.

They can also be used for applications where there is little space, such as air conditioners, heating systems, pumps and fans, i.e. for simple electrical controls.

#### Technical specifications

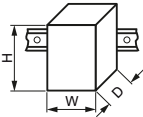
More information	
Technical specifications, see <a href="https://support.industry.siemens.com/cs/ww/en/ps/16186/td">https://support.industry.siemens.com/cs/ww/en/ps/16186/td</a>	Reference Manual for switching devices, see <a href="https://support.industry.siemens.com/cs/ww/en/view/35554359">https://support.industry.siemens.com/cs/ww/en/view/35554359</a> FAQs, see <a href="https://support.industry.siemens.com/cs/ww/en/ps/16186/faq">https://support.industry.siemens.com/cs/ww/en/ps/16186/faq</a>
Type	<b>3TG10</b>
<b>General data</b>	
<b>Dimensions (W x H x D)</b>	mm 36 x 56 x 56
	
<b>Endurance</b>	
• Mechanical	Operating cycles 3 million
• Electrical	
- AC-1 at $I_e$	Operating cycles 0.1 million
- AC-3/AC-3e at $I_e$	Operating cycles 0.4 million
<b>Rated insulation voltage <math>U_i</math></b> (pollution degree 3)	V 400
<b>Rated impulse withstand voltage <math>U_{imp}</math></b>	kV 4
<b>Protective separation</b>	
Between the coil and the contacts according to IEC 60947-1, Annex N	V Up to 300
<b>Permissible ambient temperature</b>	
• During operation <sup>1)</sup>	°C -25 ... + 55
• During storage	°C -50 ... + 80
<b>Short-circuit protection</b>	
<b>Fuse links</b> , operational class gG: LV HRC, type 3NA; DIAZED, type 5SB; NEOZED, type 5SE according to IEC 60947-4-1	
• Type of coordination "1"	A 25
• Type of coordination "2"	A 10
<b>Miniature circuit breakers</b> , C characteristic	A 10
<b>Control</b>	
<b>Solenoid coil operating range</b>	0.85 ... 1.1 x $U_s$
<b>Power consumption of the solenoid coils</b> (for cold coil and 1.0 x $U_s$ )	
• AC operation, 45 ... 450 Hz	VA 4.4
- P.f.	0.9 (hum-free)
• DC operation	W 4
<b>Rated data of the main contacts</b>	
<b>Load rating with AC</b>	
<b>Utilization category AC-1</b>	
• Rated operational current $I_e$ up to 400 V at 55 °C <sup>1)</sup>	A 20 for screw terminals, 16 for flat connectors
• Rated power $U_e$ for AC loads with p.f. = 1, 230/220 V	
- For screw terminals	kW 7.5 (13 at 400 V)
- For flat connectors	kW 6 (10 at 400 V)
• Minimum conductor cross-section for loads with $I_e$	mm <sup>2</sup> 2.5

<sup>1)</sup> If the three main conducting paths carry a load of 20 A, the following applies if  $I > 10$  A in the fourth conducting path: Permissible ambient temperature 40 °C.

# Switching devices – Contactors and contactor assemblies – for switching motors

## Power contactors for switching motors

### 3TG10 power relays/miniature contactors

Type				3TG10
<b>Rated data of the main contacts (continued)</b>				
<b>Load rating with AC</b>				
<b>Utilization category AC-3 and AC-3e</b>				
• Operational current for AC-3/AC-3e at $U_e \leq 400$ V rated value			A	8.4/6.4
• Rated power for slip-ring or squirrel-cage motors for AC-3/AC-3e, at 50 and 60 Hz and at $U_e \leq 400$ V			kW	4/3
<b>Utilization category AC-5a</b> (permissible nominal impedance: $\geq 0.5 \Omega$ )				
<b>Switching of gas discharge lamps</b>				
Per main conducting path at 230 V, 50 Hz				
	Rated power per lamp	Rated operational current per lamp		
• Uncompensated	18 W	0.37 A	Unit(s)	43
	36 W	0.43 A	Unit(s)	37
	58 W	0.67 A	Unit(s)	24
• DUO switching	18 W	2 x 0.11 A	Unit(s)	2 x 81
	36 W	2 x 0.21 A	Unit(s)	2 x 42
	58 W	2 x 0.32 A	Unit(s)	2 x 28
<b>Switching of gas discharge lamps with compensation or ECG</b>				
Per main conducting path 230 V, 50 Hz				
Connection	Rated power per lamp	Capacitor capacitance	Rated operational current per lamp	
• Shunt compensation	L18 W	4.5 $\mu$ F	0.11 A	Unit(s) 15
	L36 W	4.5 $\mu$ F	0.21 A	Unit(s) 15
	L58 W	7 $\mu$ F	0.32 A	Unit(s) 10
• With ECG (single lamp)	L18 W	6.8 $\mu$ F	0.10 A	Unit(s) 39
	L36 W	6.8 $\mu$ F	0.18 A	Unit(s) 39
	L58 W	10 $\mu$ F	0.27 A	Unit(s) 26
• With ECG (two lamps)	L18 W	10 $\mu$ F	0.18 A	Unit(s) 2 x 26
	L36 W	10 $\mu$ F	0.35 A	Unit(s) 2 x 26
	L58 W	22 $\mu$ F	0.52 A	Unit(s) 2 x 12
<b>Utilization category AC-5b, switching incandescent lamps</b>				kW 1.6
Per main conducting path at 230 V, 50 Hz				
<b>Load rating with DC</b>				
<b>Utilization category DC-1, (<math>L/R \leq 15</math> ms)</b>				
• Rated operational currents $I_e$				
- 1 conducting path			Up to 24 V A	16
			60 V A	6
			110 V A	2
			220 V/240 V A	0.8
- 2 conducting paths in series			Up to 24 V A	16
			60 V A	16
			110 V A	6
			220 V/240 V A	1.6
- 3 conducting paths in series			Up to 24 V A	18
			60 V A	18
			110 V A	16
			220 V/240 V A	6
<b>Utilization category DC-3 and DC-5</b>				
<b>Shunt-wound and series-wound motors (<math>L/R \leq 15</math> ms)</b>				
• Rated operational currents $I_e$				
- 1 conducting path			Up to 24 V A	10
			60 V A	0.5
			110 V A	0.15
			220 V/240 V A	0
- 2 conducting paths in series			Up to 24 V A	16
			60 V A	5
			110 V A	0.35
			220 V/240 V A	0
- 3 conducting paths in series			Up to 24 V A	16
			60 V A	16
			110 V A	10
			220 V/240 V A	1.75

## Switching devices – Contactors and contactor assemblies – for switching motors

### Power contactors for switching motors

#### 3TG10 power relays/miniature contactors

Type	<b>3TG10</b>	
<b>Conductor cross-sections</b>		
<ul style="list-style-type: none"> <li>Terminal screws</li> <li>Finely stranded with end sleeve (DIN 46228 Form A/D/C)</li> <li>Solid</li> <li>Permissible opening tool (screwdriver)</li> </ul>		
	mm <sup>2</sup>	mm <sup>2</sup>
<ul style="list-style-type: none"> <li>Finely stranded 6.3 mm plug-in sleeve according to DIN 46245/DIN 46247</li> <li>- 6.3 ... 1</li> <li>- 6.3 ... 2.5</li> </ul>		
	mm <sup>2</sup>	mm <sup>2</sup>
<b>Ⓢ and Ⓣ rating (screw terminals)</b>		
<b>Rated insulation voltage</b>	V AC	600
<b>Uninterrupted current</b>	Open and enclosed	A
		20
<b>Maximum horsepower ratings</b> (from Ⓢ and Ⓣ approved values)		
1-phase/3-phase		
<ul style="list-style-type: none"> <li>Rated power for three-phase motors at 60 Hz</li> </ul>		
	at 115 V	hp
	200 V	hp
	230 V	hp
	460 ... 600 V	hp
		0.5/--
		1/3
		1.5/3
		0/5

# Switching devices – Contactors and contactor assemblies – for switching motors

## Power contactors for switching motors

AC-3e

IE3/IE4 ready

3TG10 power relays/miniature contactors

### Selection and ordering data

**AC operation**  or **DC operation** 

For screw fixing and snap-on mounting on TH 35 DIN rail

Rated data				Auxiliary contacts	Rated control supply voltage $U_s$	Article No.	Price per PU	PU (UNIT, SET, M)	PS*	PG
Utilization category				Version						
AC-1 at 55 °C		AC-3/AC-3e				NO	NC			
Operational current $I_e$ up to 400 V	Power of AC loads at 50 Hz and 400 V	Operational current $I_e$ up to 400 V <sup>1)</sup>	Power of AC loads at 50 Hz and 400 V							
A	kW	A	kW	V						

#### Hum-free · with screw terminals



3TG10...-0...

#### AC operation, 45 ... 450 Hz

Operational current $I_e$ up to 400 V	Power of AC loads at 50 Hz and 400 V	Operational current $I_e$ up to 400 V <sup>1)</sup>	Power of AC loads at 50 Hz and 400 V	Auxiliary contacts	Rated control supply voltage $U_s$	Article No.	Price per PU	PU (UNIT, SET, M)	PS*	PG
20	13	8.4/6.4	4/3	1 --	24 AC 110 AC 230 AC	<b>3TG1010-0AC2</b>		1	1 unit	41H
						<b>3TG1010-0AG2</b>		1	1 unit	41H
						<b>3TG1010-0AL2</b>		1	1 unit	41H
				-- 1	24 AC 110 AC 230 AC	<b>3TG1001-0AC2</b>		1	1 unit	41H
						<b>3TG1001-0AG2</b>		1	1 unit	41H
						<b>3TG1001-0AL2</b>		1	1 unit	41H

#### DC operation

Operational current $I_e$ up to 400 V	Power of AC loads at 50 Hz and 400 V	Operational current $I_e$ up to 400 V <sup>1)</sup>	Power of AC loads at 50 Hz and 400 V	Auxiliary contacts	Rated control supply voltage $U_s$	Article No.	Price per PU	PU (UNIT, SET, M)	PS*	PG
20	13	8.4/6.4	4/3	1 --	24 DC	<b>3TG1010-0BB4</b>		1	1 unit	41H
				-- 1	24 DC	<b>3TG1001-0BB4</b>		1	1 unit	41H

#### Hum-free · with 6.3 mm x 0.8 mm flat connectors



3TG10...-1...

#### AC operation, 45 ... 450 Hz

Operational current $I_e$ up to 400 V	Power of AC loads at 50 Hz and 400 V	Operational current $I_e$ up to 400 V <sup>1)</sup>	Power of AC loads at 50 Hz and 400 V	Auxiliary contacts	Rated control supply voltage $U_s$	Article No.	Price per PU	PU (UNIT, SET, M)	PS*	PG
16	10	8.4/6.4	4/3	1 --	24 AC 110 AC 230 AC	<b>3TG1010-1AC2</b>		1	1 unit	41H
						<b>3TG1010-1AG2</b>		1	1 unit	41H
						<b>3TG1010-1AL2</b>		1	1 unit	41H
				-- 1	24 AC 110 AC 230 AC	<b>3TG1001-1AC2</b>		1	1 unit	41H
						<b>3TG1001-1AG2</b>		1	1 unit	41H
						<b>3TG1001-1AL2</b>		1	1 unit	41H

#### DC operation

Operational current $I_e$ up to 400 V	Power of AC loads at 50 Hz and 400 V	Operational current $I_e$ up to 400 V <sup>1)</sup>	Power of AC loads at 50 Hz and 400 V	Auxiliary contacts	Rated control supply voltage $U_s$	Article No.	Price per PU	PU (UNIT, SET, M)	PS*	PG
16	10	8.4/6.4	4/3	1 --	24 DC	<b>3TG1010-1BB4</b>		1	1 unit	41H
				-- 1	24 DC	<b>3TG1001-1BB4</b>		1	1 unit	41H

<sup>1)</sup> The rated operational currents apply to each pole.

### Accessories

Version	Max. rated operational currents $I_e$ /AC-1 (at 55 °C) of the contactors	Max. conductor cross-sections	Screw terminals	PU (UNIT, SET, M)	PS*	PG
			Article No.	Price per PU		
	A	mm <sup>2</sup>				

#### Links for paralleling (insulated star jumpers)<sup>1)</sup>



3RT1916-4BB31

Version	Max. rated operational currents $I_e$ /AC-1 (at 55 °C) of the contactors	Max. conductor cross-sections	Screw terminals	PU (UNIT, SET, M)	PS*	PG
<b>3-pole</b>						
• Without connecting terminal	16	--	<b>3RT1916-4BA31</b>	1	1 unit	41B
• With connecting terminal	40	25	<b>3RT1916-4BB31</b>	1	1 unit	41B
<b>4-pole</b>						
• With connecting terminal	40	25	<b>3RT1916-4BB41</b>	1	1 unit	41B

<sup>1)</sup> The links for paralleling can be reduced by one pole. The rated operational currents apply to each pole.

## Switching devices – Contactors and contactor assemblies – for switching motors

### Reversing contactor assemblies

#### SIRIUS 3RA23 reversing contactor assemblies, up to 55 kW

##### Overview

###### More information

Homepage, see [www.siemens.com/sirius](http://www.siemens.com/sirius)

Industry Mall, see [www.siemens.com/product?3RA23\\_3RT1](http://www.siemens.com/product?3RA23_3RT1)

Conversion tool, see [www.siemens.com/conversion-tool](http://www.siemens.com/conversion-tool)

TIA Selection Tool Cloud (TST Cloud), see

[www.siemens.com/tstcloud/?node=LoadFeeder](http://www.siemens.com/tstcloud/?node=LoadFeeder)

Guide of use for contactors in safety applications, see

<https://support.industry.siemens.com/cs/ww/en/view/109807687>

The 3RA23 reversing contactor assemblies in sizes S00 to S3 can be ordered as follows:

- Fully wired and tested, with mechanical and electrical interlock, see [page 3/149 onwards](#).
- For all individual parts for customer assembly, see [page 3/69 onwards](#).

The 3RA23 reversing contactor assemblies have screw terminals or spring-loaded terminals (main and control circuits) and are suitable for screw fixing and snap-on mounting on TH 35 DIN rails.

##### **Complete 3RA23 reversing contactor assemblies**

The 3RA23 reversing contactor assemblies of size S00 to S3 each consist of two contactors with the same power, with one NC contact (S00) or one NO contact and one NC contact (S0 to S3) in the basic unit. The contactors are mechanically and electrically interlocked (NC contact interlock).

3RU2 overload relays (see [page 7/89 onwards](#)) or 3RB3 overload relays (see [page 7/102 onwards](#)) for contactor mounting or stand-alone installation, SIMOCODE pro 3UF7 motor management and control devices (see [page 10/12 onwards](#)) or 3RN2 thermistor motor protection relays (see [page 10/136 onwards](#)) can be used for motor protection.

##### **3RA23 reversing contactor assemblies with voltage tap-off**

The reversing contactor assemblies with voltage tap-off (see [pages 3/149 to 3/152](#)) are required for mounting the function modules for connection to the controller via the IO-Link or AS-Interface communications systems. The 3RA27 function modules must be ordered separately, see [page 3/101](#).



For more information on IO-Link and AS-Interface, see "Industrial communication", [page 2/1 onwards](#).

# Switching devices – Contactors and contactor assemblies – for switching motors

## Reversing contactor assemblies

### SIRIUS 3RA23 reversing contactor assemblies, up to 55 kW

#### Sizes S00 to S3

Rated data for AC-3/AC-3e at AC 50 Hz 400 V		Size	Type	Contactor (see page 3/47 onwards)	Assembly kit (see page 3/104)	Fully wired and tested reversing contactor assemblies
Rating P kW	Operational current $I_e$ A					
 <b>Screw terminals</b>						
3	7	<b>S00-S00</b>		3RT2015-1...2	3RA2913-2AA1	<b>3RA2315-8XB30-1...</b>
4	9			3RT2016-1...2	3RA2913-2AA1	<b>3RA2316-8XB30-1...</b>
5.5	12			3RT2017-1...2	3RA2913-2AA1	<b>3RA2317-8XB30-1...</b>
7.5	16			3RT2018-1...2	3RA2913-2AA1	<b>3RA2318-8XB30-1...</b>
5.5	12	<b>S0-S0</b>		3RT2024-1...0	3RA2923-2AA1	<b>3RA2324-8XB30-1...</b>
7.5	17			3RT2025-1...0	3RA2923-2AA1	<b>3RA2325-8XB30-1...</b>
11	25			3RT2026-1...0	3RA2923-2AA1	<b>3RA2326-8XB30-1...</b>
15	32			3RT2027-1...0	3RA2923-2AA1	<b>3RA2327-8XB30-1...</b>
18.5	38			3RT2028-1...0	3RA2923-2AA1	<b>3RA2328-8XB30-1...</b>
18.5	41	<b>S2-S2</b>		3RT2035-1...0	3RA2933-2AA1	<b>3RA2335-8XB30-1...</b>
22	51			3RT2036-1...0	3RA2933-2AA1	<b>3RA2336-8XB30-1...</b>
30	65			3RT2037-1...0	3RA2933-2AA1	<b>3RA2337-8XB30-1...</b>
37	80			3RT2038-1...0	3RA2933-2AA1	<b>3RA2338-8XB30-1...</b>
37	80	<b>S3-S3</b>		3RT2045-1...0	3RA2943-2AA1	<b>3RA2345-8XB30-1...</b>
45	95			3RT2046-1...0	3RA2943-2AA1	<b>3RA2346-8XB30-1...</b>
55	110			3RT2047-1...0	3RA2943-2AA1	<b>3RA2347-8XB30-1...</b>
 <b>Spring-loaded terminals</b>						
3	7	<b>S00-S00</b>		3RT2015-2...2	3RA2913-2AA2	<b>3RA2315-8XB30-2...</b>
4	9			3RT2016-2...2	3RA2913-2AA2	<b>3RA2316-8XB30-2...</b>
5.5	12			3RT2017-2...2	3RA2913-2AA2	<b>3RA2317-8XB30-2...</b>
7.5	16			3RT2018-2...2	3RA2913-2AA2	<b>3RA2318-8XB30-2...</b>
5.5	12	<b>S0-S0</b>		3RT2024-2...0	3RA2923-2AA2	<b>3RA2324-8XB30-2...</b>
7.5	17			3RT2025-2...0	3RA2923-2AA2	<b>3RA2325-8XB30-2...</b>
11	25			3RT2026-2...0	3RA2923-2AA2	<b>3RA2326-8XB30-2...</b>
15	32			3RT2027-2...0	3RA2923-2AA2	<b>3RA2327-8XB30-2...</b>
18.5	38			3RT2028-2...0	3RA2923-2AA2	<b>3RA2328-8XB30-2...</b>

#### Article number scheme

Product versions	Article number
<b>SIRIUS reversing contactor assembly</b>	<b>3RA23</b> <input type="checkbox"/> <input type="checkbox"/> - <input type="checkbox"/> <input type="checkbox"/> <input type="checkbox"/> <input type="checkbox"/> - <input type="checkbox"/> <input type="checkbox"/> <input type="checkbox"/> <input type="checkbox"/>
Size of the contactor	e.g. 4 = S3 <input type="checkbox"/>
Rating dependent on size	e.g. 5 = 37 kW for size S3 <input type="checkbox"/>
Type of overload relay	e.g. 8X = Without <input type="checkbox"/> <input type="checkbox"/>
Assembly	e.g. E = Communication-capable installation <input type="checkbox"/>
Interlock	e.g. 3 = Mechanical and electrical <input type="checkbox"/>
Free auxiliary switches	e.g. 0 = S3: 2 NO total <input type="checkbox"/>
Type of electrical connection	e.g. 1 = Screw terminals (main and auxiliary circuits) <input type="checkbox"/>
Operating range/solenoid coil circuit	e.g. A = AC standard/without coil circuit <input type="checkbox"/>
Rated control supply voltage	e.g. L2 = 230 V AC, 50/60 Hz <input type="checkbox"/> <input type="checkbox"/>
Example	<b>3RA23 4 5 - 8 X E 3 0 - 1 A L 2</b>

#### Note:

The article number scheme shows an overview of product versions for better understanding of the logic behind the article numbers.

For your orders, please use the article numbers quoted in the selection and ordering data.

# Switching devices – Contactors and contactor assemblies – for switching motors

## Reversing contactor assemblies

### SIRIUS 3RA23 reversing contactor assemblies, up to 55 kW

#### Fully wired and tested reversing contactor assemblies · Size S00-S00 · Up to 7.5 kW

The figure shows the version with screw terminals

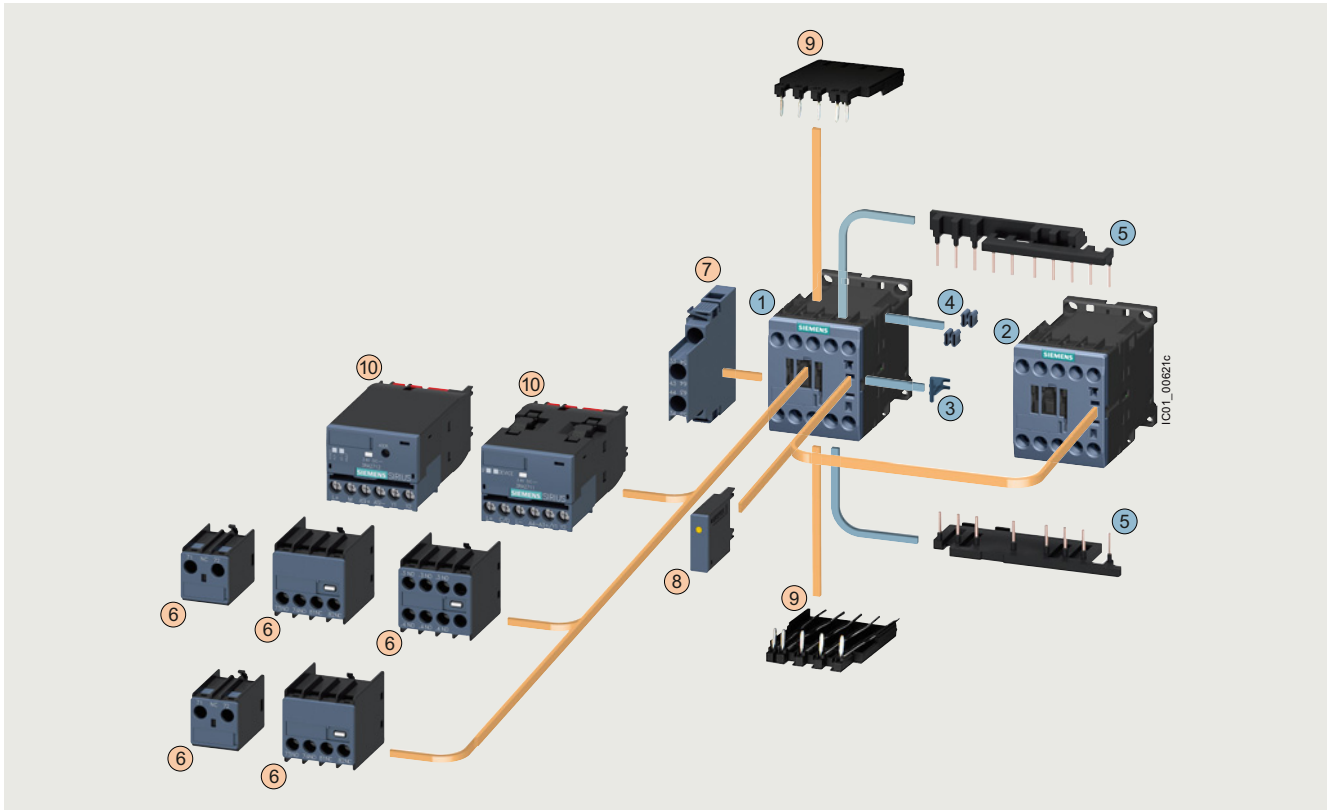

#### Mountable accessories (optional)

To be ordered separately	Type	Page
⑥ Auxiliary switch, front <sup>1)</sup>	3RH2911	3/87 ... 3/89
⑦ Auxiliary switch, lateral	3RH2921	3/91
⑧ Surge suppressor	3RT2916	3/97, 3/98
⑨ Solder pin adapter	3RT1916-4KA1	3/111
⑩ Function module for connection to the control system	3RA271.-1BA00	3/101

#### Complete reversing contactor assembly

Individual parts	Type	Page
① ② Contactors, 3 kW	3RT2015 3RT2015	3/47, 3/52, 3/53
① ② Contactors, 4 kW	3RT2016 3RT2016	3/47, 3/52, 3/53
① ② Contactors, 5.5 kW	3RT2017 3RT2017	3/47, 3/52, 3/53
① ② Contactors, 7.5 kW	3RT2018 3RT2018	3/47, 3/52, 3/53
③ ... ⑤ Assembly kit comprising:	3RA2913-2AA1	3/104
③ Mechanical interlock <sup>2)</sup>		
④ Two connecting clips for two contactors <sup>2)</sup>		
⑤ Wiring modules on the top and bottom for connecting the main current paths, electrical interlock included <sup>3)</sup> , interruptible (NC contact interlock)		

<sup>1)</sup> Auxiliary switch according to EN 50005 must be used.

<sup>2)</sup> The parts ③ and ④ can only be ordered together as 3RA2912-2H mechanical connectors.

<sup>3)</sup> 3RT201. contactors with one NC contact in the basic unit are required for the electrical interlock. An additional NO contact is required for momentary-contact operation.

For complete reversing contactor assemblies, see page 3/149.



## Switching devices – Contactors and contactor assemblies – for switching motors

### Reversing contactor assemblies

SIRIUS 3RA23 reversing contactor assemblies, up to 55 kW

Fully wired and tested reversing contactor assemblies · Size S0-S0 · Up to 18.5 kW

The figure shows the version with screw terminals

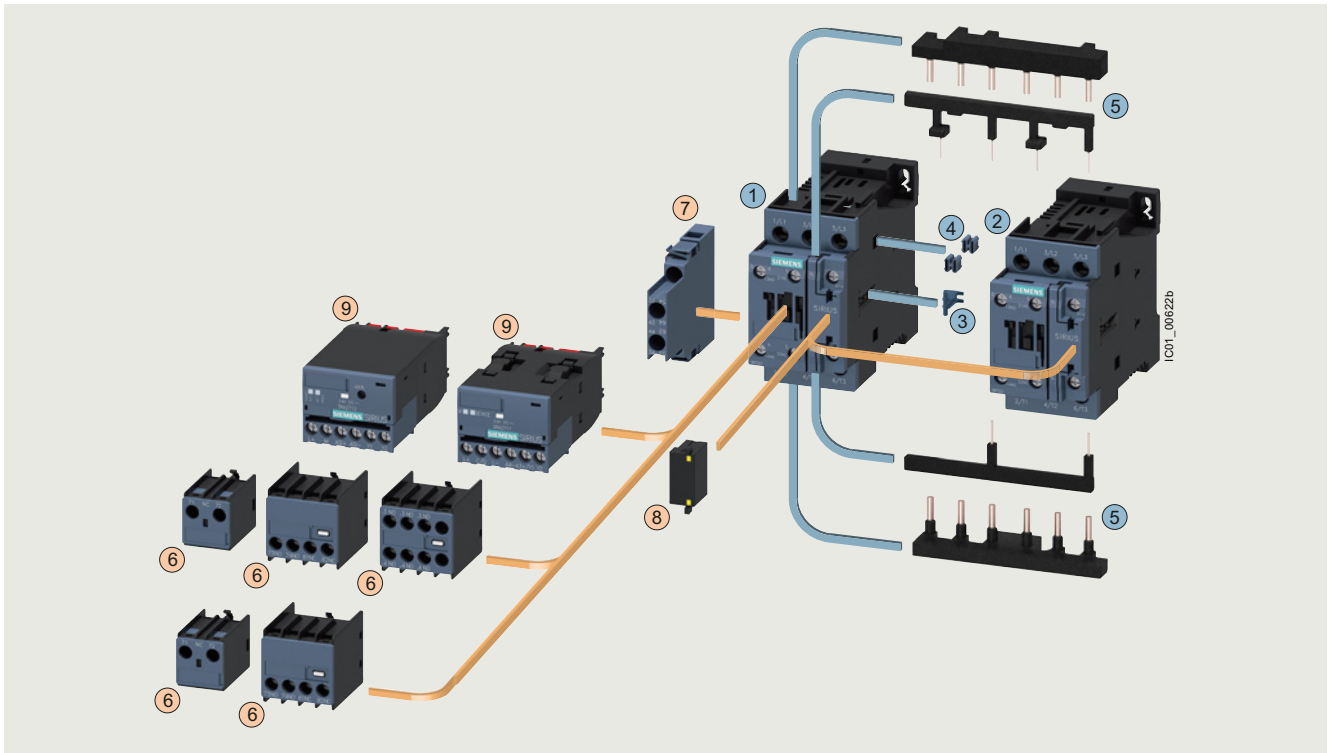

#### Mountable accessories (optional)

To be ordered separately	Type	Page
⑥ Auxiliary switch, front	3RH2911	3/87 ... 3/89
⑦ Auxiliary switch, lateral	3RH2921	3/91
⑧ Surge suppressor	3RT2926	3/97, 3/98
⑨ Function module for connection to the control system	3RA271.-1BA00	3/101

#### Complete reversing contactor assembly

Individual parts	Type		Page
	Q11	Q12	
①② Contactors, 5.5 kW	3RT2024	3RT2024	3/48, 3/56, 3/57
①② Contactors, 7.5 kW	3RT2025	3RT2025	3/48, 3/56, 3/57
①② Contactors, 11 kW	3RT2026	3RT2026	3/48, 3/56, 3/57
①② Contactors, 15 kW	3RT2027	3RT2027	3/48, 3/56, 3/57
①② Contactors, 18.5 kW	3RT2028	3RT2028	3/48, 3/56, 3/57
③ ... ⑤ Assembly kit comprising:	3RA2923-2AA1		3/104
③	Mechanical interlock <sup>1)</sup>		
④	Two connecting clips for two contactors <sup>1)</sup>		
⑤	Wiring modules on the top and bottom for connecting the main current paths, electrical interlock included (NC contact interlock)		

<sup>1)</sup> The parts ③ and ④ can only be ordered together as 3RA2922-2H mechanical connectors.

For complete reversing contactor assemblies, see page 3/150.

## Switching devices – Contactors and contactor assemblies – for switching motors

### Reversing contactor assemblies

#### SIRIUS 3RA23 reversing contactor assemblies, up to 55 kW

**Fully wired and tested reversing contactor assemblies · Size S2-S2 · Up to 37 kW**

The figure shows the version with screw terminals

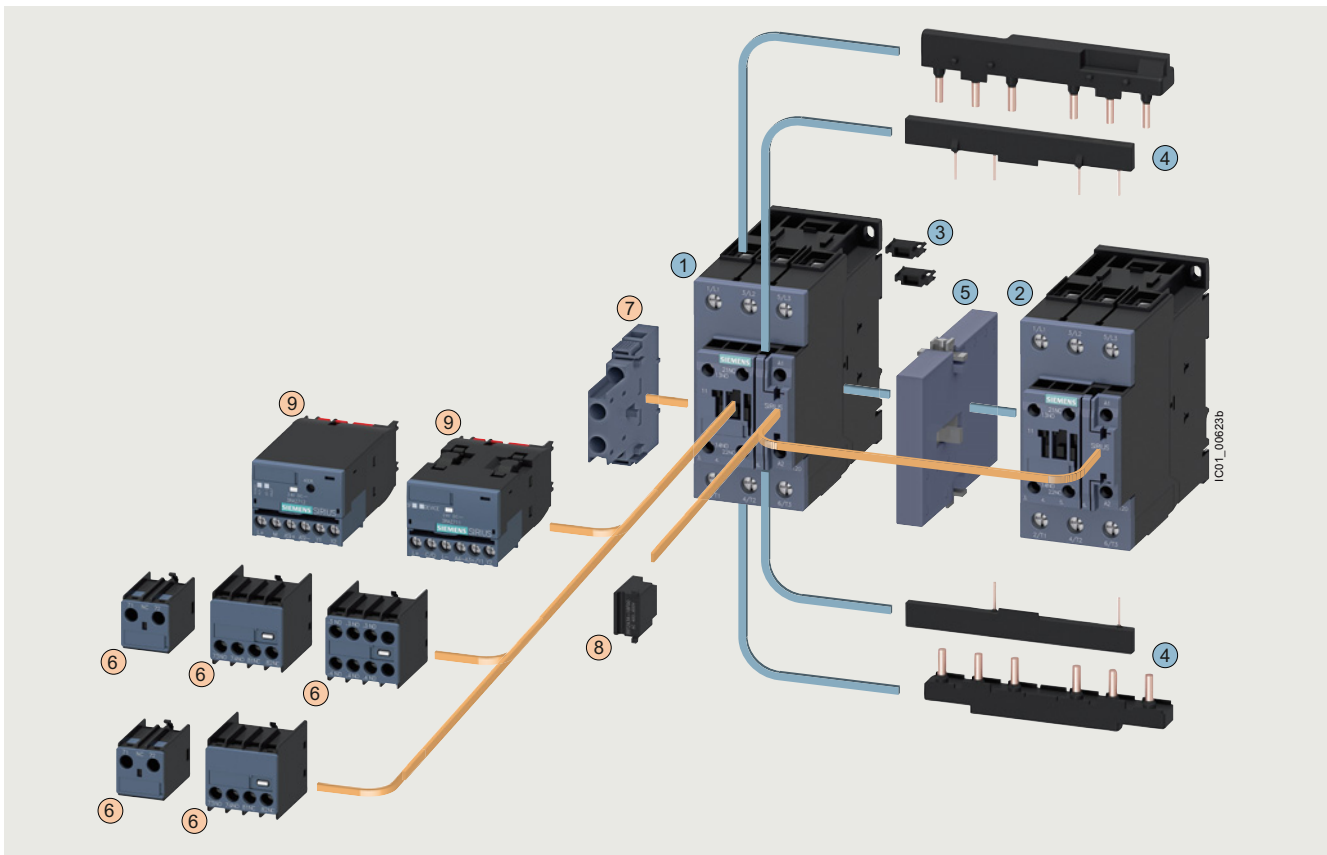

#### Mountable accessories (optional)

To be ordered separately	Type	Page
⑥ Auxiliary switch, front	3RH2911	3/87 ... 3/89
⑦ Auxiliary switch, lateral	3RH2921	3/91
⑧ Surge suppressor	3RT2936	3/97, 3/98
⑨ Function module for connection to the control system	3RA271.-1BA00	3/101

#### Complete reversing contactor assembly

Individual parts	Type		Page
	Q11	Q12	
①② Contactors, 18.5 kW	3RT2035	3RT2035	3/50, 3/61
①② Contactors, 22 kW	3RT2036	3RT2036	3/50, 3/61
①② Contactors, 30 kW	3RT2037	3RT2037	3/50, 3/61
①② Contactors, 37 kW	3RT2038	3RT2038	3/50, 3/61
③④ Assembly kit comprising:	3RA2933-2AA1		3/104
③ Two connectors for two contactors			
④ Wiring modules on the top and bottom for connecting the main and auxiliary circuits, electrical interlock included (NC contact interlock)			
⑤ Mechanical interlock	3RA2934-2B		3/108

For complete reversing contactor assemblies, [see page 3/151](#).

# Switching devices – Contactors and contactor assemblies – for switching motors

## Reversing contactor assemblies

### SIRIUS 3RA23 reversing contactor assemblies, up to 55 kW

**Fully wired and tested reversing contactor assemblies · Size S3-S3 · Up to 55 kW**

The figure shows the version with screw terminals

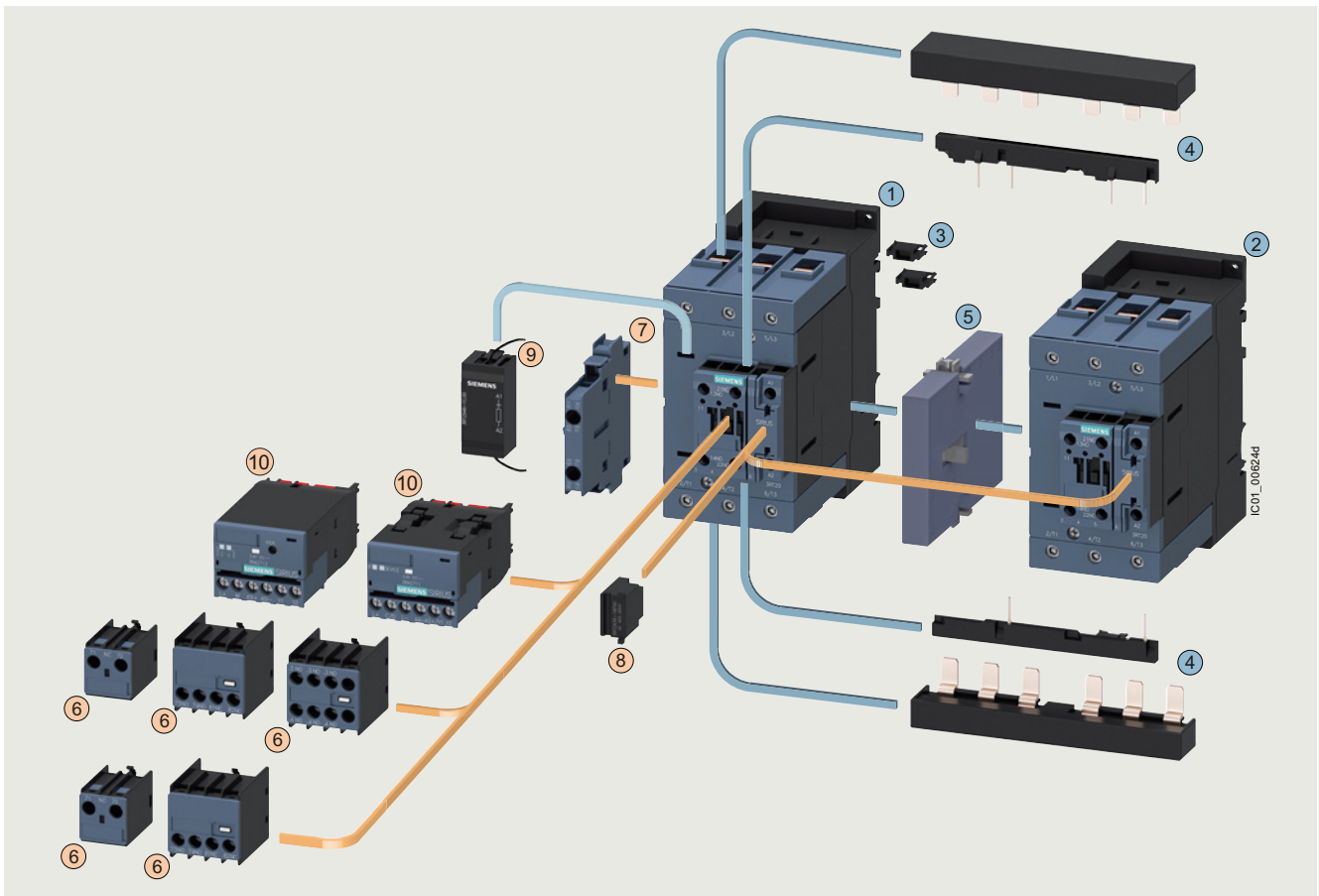

#### Mountable accessories (optional)

To be ordered separately	Type	Page
⑥ Auxiliary switch, front	3RH2911	3/87 ... 3/89
⑦ Auxiliary switch, lateral	3RH2921	3/91
⑧ Surge suppressor (varistor, diode assembly)	3RT2936	3/97, 3/98
⑨ Surge suppressor (RC element)	3RT2946	3/97
⑩ Function module for connection to the control system (the associated module connectors 3RA2711-0EE17 must be ordered separately, see page 3/102)	3RA271.-1BA00	3/101

#### Complete reversing contactor assembly

Individual parts	Type		Page
	Q11	Q12	
①② Contactors, 37 kW	3RT2045	3RT2045	3/51, 3/63
①② Contactors, 45 kW	3RT2046	3RT2046	3/51, 3/63
①② Contactors, 55 kW	3RT2047	3RT2047	3/51, 3/63
③④ Assembly kit comprising:	3RA2943-2AA1		3/104
③ Two connectors for two contactors			
④ Wiring modules on the top and bottom for connecting the main and auxiliary circuits, electrical interlock included (NC contact interlock)			
⑤ Mechanical interlock	3RA2934-2B		3/108

For complete reversing contactor assemblies, see page 3/152.

## Switching devices – Contactors and contactor assemblies – for switching motors

### Reversing contactor assemblies

#### SIRIUS 3RA23 reversing contactor assemblies, up to 55 kW

##### Benefits

Using wiring kits for reversing contactor assemblies has the following advantages:

- Notable reduction of wiring in the control circuit
- Integrated mechanical interlock for sizes S00 to S3
- Prevention of wiring errors in the main circuit

Connecting combs for screw terminals also result in:

- Prevention of wiring errors in the control circuit
- Reduction of testing costs
- Ready-jumpered actuation of the auxiliary switches and the frame (A2)
- Integrated electrical interlocking

##### Accessories

###### Selecting the auxiliary switches

The following points should be noted:

###### Size S00

- For maintained-contact operation:  
Use contactors with an NC contact in the basic unit for the electrical interlock.
- For momentary-contact operation:  
Use contactors with an NC contact in the basic unit for the electrical interlock; in addition, an auxiliary switch with at least one NO contact for self-locking is required per contactor.

###### Sizes S0 to S3

- For maintained-contact operation:  
The contactors have two integrated auxiliary contacts (1 NO contact + 1 NC contact); the NC contact can be used for electrical interlocking.
- For momentary-contact operation:  
Electrical interlock as for maintained-contact operation; the NO contact in the basic unit can be used for the latching.

###### Surge suppression

###### Sizes S00 to S3

All reversing contactor assemblies can be fitted with RC elements or varistors for damping switching overvoltages in the coil.

As with the individual contactors, the surge suppressors can either be plugged onto the top of the contactors (S00) or be plugged into the front of the contactors (S0 to S3).

##### Technical specifications

###### More information

Technical specifications, see <https://support.industry.siemens.com/cs/ww/en/ps/16146/td>  
FAQs, see <https://support.industry.siemens.com/cs/ww/en/ps/16146/faq>

System Manual for modular system, see <https://support.industry.siemens.com/cs/ww/en/view/60311318>  
Equipment Manual, see <https://support.industry.siemens.com/cs/ww/en/view/60306557>  
Application Manual - Switching devices with IE3 and IE4 motors, see <https://support.industry.siemens.com/cs/ww/en/view/94770820>  
Guide of use for contactors in safety applications, see <https://support.industry.siemens.com/cs/ww/en/view/109807687>

The technical specifications are the same as for the individual contactors (see page 3/25 onwards).

# Switching devices – Contactors and contactor assemblies – for switching motors

## Reversing contactor assemblies

**AC-3e** **IE3/IE4 ready** SIRIUS 3RA23 reversing contactor assemblies, up to 55 kW

### Selection and ordering data

**Fully wired and tested reversing contactor assemblies<sup>1)</sup> · Size S00-S00 · Up to 7.5 kW**
**AC operation**  **or DC operation** 

 PU (UNIT, SET, M) = 1  
 PS\* = 1 unit  
 PG = 41B



3RA231.-8XB30-1A.0



3RA231.-8XE30-1BB4



3RA231.-8XB30-2A.0

Rated data AC-3 and AC-3e					Rated control supply voltage $U_s$	Screw terminals 		Spring-loaded terminals 	
Operational current $I_e$ up to 400 V	Ratings of three-phase motors at 50 Hz and 60 Hz			Article No.		Price per PU	Article No.	Price per PU	
	A	230 V	400 V		690 V				kW
<b>AC operation, 50/60 Hz</b>									
7	2.2	<b>3</b>	4	24 AC	<b>3RA2315-8XB30-1AB0</b>	<b>3RA2315-8XB30-2AB0</b>	<b>3RA2315-8XB30-1AF0</b>	<b>3RA2315-8XB30-2AF0</b>	<b>3RA2315-8XB30-2AP0</b>
				110 AC	<b>3RA2315-8XB30-1AP0</b>				
				230 AC					
9	3	<b>4</b>	5.5	24 AC	<b>3RA2316-8XB30-1AB0</b>	<b>3RA2316-8XB30-2AB0</b>	<b>3RA2316-8XB30-1AF0</b>	<b>3RA2316-8XB30-2AF0</b>	<b>3RA2316-8XB30-2AP0</b>
				110 AC	<b>3RA2316-8XB30-1AP0</b>				
				230 AC					
12	3	<b>5.5</b>	5.5	24 AC	<b>3RA2317-8XB30-1AB0</b>	<b>3RA2317-8XB30-2AB0</b>	<b>3RA2317-8XB30-1AF0</b>	<b>3RA2317-8XB30-2AF0</b>	<b>3RA2317-8XB30-2AP0</b>
				110 AC	<b>3RA2317-8XB30-1AP0</b>				
				230 AC					
16	4	<b>7.5</b>	7.5	24 AC	<b>3RA2318-8XB30-1AB0</b>	<b>3RA2318-8XB30-2AB0</b>	<b>3RA2318-8XB30-1AF0</b>	<b>3RA2318-8XB30-2AF0</b>	<b>3RA2318-8XB30-2AP0</b>
				110 AC	<b>3RA2318-8XB30-1AP0</b>				
				230 AC					
<b>DC operation</b>									
7	2.2	<b>3</b>	4	24 DC	<b>3RA2315-8XB30-1BB4</b>	<b>3RA2315-8XB30-2BB4</b>			
9	3	<b>4</b>	5.5	24 DC	<b>3RA2316-8XB30-1BB4</b>				
12	3	<b>5.5</b>	5.5	24 DC	<b>3RA2317-8XB30-1BB4</b>				
16	4	<b>7.5</b>	7.5	24 DC	<b>3RA2318-8XB30-1BB4</b>				
<b>With voltage tap-off</b>									
7	2.2	<b>3</b>	4	24 DC	<b>3RA2315-8XE30-1BB4</b>	<b>3RA2315-8XE30-2BB4</b>			
9	3	<b>4</b>	5.5	24 DC	<b>3RA2316-8XE30-1BB4</b>				
12	3	<b>5.5</b>	5.5	24 DC	<b>3RA2317-8XE30-1BB4</b>				
16	4	<b>7.5</b>	7.5	24 DC	<b>3RA2318-8XE30-1BB4</b>				

<sup>1)</sup> The contactors integrated in the reversing contactor assemblies have no unassigned auxiliary contacts. When used with a voltage tap-off and function module, the auxiliary contacts are unassigned.

Representation of the complete reversing contactor assemblies with optionally mountable accessories, see page 3/144.

## Switching devices – Contactors and contactor assemblies – for switching motors

### Reversing contactor assemblies

**SIRIUS 3RA23 reversing contactor assemblies, up to 55 kW** **IE3/IE4 ready** **AC-3e**
**Fully wired and tested reversing contactor assemblies · Size S0-S0 · Up to 18.5 kW**
**AC operation**  **or DC operation** 

 PU (UNIT, SET, M) = 1  
 PS\* = 1 unit  
 PG = 41B



3RA232-8XB30-1A.2

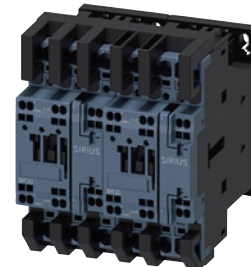

3RA2324-8XE30-1BB4



3RA232-8XB30-2A.2



Rated data AC-3 and AC-3e					Rated control supply voltage $U_s$	Screw terminals 		Spring-loaded terminals 	
Operational current $I_e$ up to 400 V	Ratings of three-phase motors at 50 Hz and 60 Hz			Article No.		Price per PU	Article No.	Price per PU	
	230 V	400 V	690 V		A				kW
<b>AC operation, 50/60 Hz</b>									
12	3	5.5	7.5	24 AC	<b>3RA2324-8XB30-1AC2</b>		<b>3RA2324-8XB30-2AC2</b>		
				110 AC	<b>3RA2324-8XB30-1AG2</b>		<b>3RA2324-8XB30-2AG2</b>		
				230 AC	<b>3RA2324-8XB30-1AL2</b>		<b>3RA2324-8XB30-2AL2</b>		
17	4	7.5	11	24 AC	<b>3RA2325-8XB30-1AC2</b>		<b>3RA2325-8XB30-2AC2</b>		
				110 AC	<b>3RA2325-8XB30-1AG2</b>		<b>3RA2325-8XB30-2AG2</b>		
				230 AC	<b>3RA2325-8XB30-1AL2</b>		<b>3RA2325-8XB30-2AL2</b>		
25	5.5	11	11	24 AC	<b>3RA2326-8XB30-1AC2</b>		<b>3RA2326-8XB30-2AC2</b>		
				110 AC	<b>3RA2326-8XB30-1AG2</b>		<b>3RA2326-8XB30-2AG2</b>		
				230 AC	<b>3RA2326-8XB30-1AL2</b>		<b>3RA2326-8XB30-2AL2</b>		
32	7.5	15	18.5	24 AC	<b>3RA2327-8XB30-1AC2</b>		<b>3RA2327-8XB30-2AC2</b>		
				110 AC	<b>3RA2327-8XB30-1AG2</b>		<b>3RA2327-8XB30-2AG2</b>		
				230 AC	<b>3RA2327-8XB30-1AL2</b>		<b>3RA2327-8XB30-2AL2</b>		
38	11	18.5	18.5	24 AC	<b>3RA2328-8XB30-1AC2</b>		<b>3RA2328-8XB30-2AC2</b>		
				110 AC	<b>3RA2328-8XB30-1AG2</b>		<b>3RA2328-8XB30-2AG2</b>		
				230 AC	<b>3RA2328-8XB30-1AL2</b>		<b>3RA2328-8XB30-2AL2</b>		
<b>DC operation</b>									
12	3	5.5	7.5	24 DC	<b>3RA2324-8XB30-1BB4</b>		<b>3RA2324-8XB30-2BB4</b>		
17	4	7.5	11	24 DC	<b>3RA2325-8XB30-1BB4</b>		<b>3RA2325-8XB30-2BB4</b>		
25	5.5	11	11	24 DC	<b>3RA2326-8XB30-1BB4</b>		<b>3RA2326-8XB30-2BB4</b>		
32	7.5	15	18.5	24 DC	<b>3RA2327-8XB30-1BB4</b>		<b>3RA2327-8XB30-2BB4</b>		
38	11	18.5	18.5	24 DC	<b>3RA2328-8XB30-1BB4</b>		<b>3RA2328-8XB30-2BB4</b>		
<b>With voltage tap-off</b>									
12	3	5.5	7.5	24 DC	<b>3RA2324-8XE30-1BB4</b>		<b>3RA2324-8XE30-2BB4</b>		
17	4	7.5	11	24 DC	<b>3RA2325-8XE30-1BB4</b>		<b>3RA2325-8XE30-2BB4</b>		
25	5.5	11	11	24 DC	<b>3RA2326-8XE30-1BB4</b>		<b>3RA2326-8XE30-2BB4</b>		
32	7.5	15	18.5	24 DC	<b>3RA2327-8XE30-1BB4</b>		<b>3RA2327-8XE30-2BB4</b>		
38	11	18.5	18.5	24 DC	<b>3RA2328-8XE30-1BB4</b>		<b>3RA2328-8XE30-2BB4</b>		

 Representation of the complete reversing contactor assemblies with optionally mountable accessories, [see page 3/145](#).

# Switching devices – Contactors and contactor assemblies – for switching motors

## Reversing contactor assemblies

**AC-3e IE3/IE4 ready** SIRIUS 3RA23 reversing contactor assemblies, up to 55 kW



**Fully wired and tested reversing contactor assemblies · Size S2-S2 · Up to 37 kW**
**AC operation**  **or AC/DC operation** 

 PU (UNIT, SET, M) = 1  
 PS\* = 1 unit  
 PG = 41B

3RA233.-8XB30-1A.2



3RA233.-8XE30-1NB3

Rated data AC-3 and AC-3e					Rated control supply voltage $U_s$	Screw terminals 		Spring-loaded terminals 	
Operational current $I_e$ up to 400 V	Ratings of three-phase motors at 50 Hz and 60 Hz			Article No.		Price per PU	Article No.	Price per PU	
	A	230 V	400 V		690 V				kW
<b>AC operation, 50/60 Hz</b>									
41	11	18.5	22	110 AC	3RA2335-8XB30-1AG2	--	--	--	--
				230 AC	3RA2335-8XB30-1AL2	--	--	--	--
51	15	22	22	110 AC	3RA2336-8XB30-1AG2	--	--	--	--
				230 AC	3RA2336-8XB30-1AL2	--	--	--	--
65	18.5	30	37	110 AC	3RA2337-8XB30-1AG2	--	--	--	--
				230 AC	3RA2337-8XB30-1AL2	--	--	--	--
80	22	37	45	110 AC	3RA2338-8XB30-1AG2	--	--	--	--
				230 AC	3RA2338-8XB30-1AL2	--	--	--	--
<b>AC/DC operation</b>									
<b>With integrated coil circuit (varistor integrated in electronics at the factory)</b>									
41	11	18.5	22	20 ... 33 AC/DC	3RA2335-8XB30-1NB3	--	--	--	--
51	15	22	22	20 ... 33 AC/DC	3RA2336-8XB30-1NB3	--	--	--	--
65	18.5	30	37	20 ... 33 AC/DC	3RA2337-8XB30-1NB3	--	--	--	--
80	22	37	45	20 ... 33 AC/DC	3RA2338-8XB30-1NB3	--	--	--	--
<b>With voltage tap-off</b>									
41	11	18.5	22	20 ... 33 AC/DC	3RA2335-8XE30-1NB3	--	--	--	--
51	15	22	22	20 ... 33 AC/DC	3RA2336-8XE30-1NB3	--	--	--	--
65	18.5	30	37	20 ... 33 AC/DC	3RA2337-8XE30-1NB3	--	--	--	--
80	22	37	45	20 ... 33 AC/DC	3RA2338-8XE30-1NB3	--	--	--	--

Representation of the complete reversing contactor assemblies with optionally mountable accessories, see page 3/146.



# Switching devices – Contactors and contactor assemblies – for switching motors

## Reversing contactor assemblies

SIRIUS 3RA23 reversing contactor assemblies, up to 55 kW **IE3/IE4 ready** **AC-3e**

**Fully wired and tested reversing contactor assemblies · Size S3-S3 · Up to 55 kW**

**AC operation**  **or AC/DC operation** 



PU (UNIT, SET, M) = 1  
PS\* = 1 unit  
PG = 41B



3RA234.-8XB30-1A.2



3RA234.-8XE30-1NB3

Rated data AC-3 and AC-3e					Rated control supply voltage $U_s$ <sup>1)</sup>	Screw terminals 		Spring-loaded terminals 	
Operational current $I_e$ up to		Ratings of three-phase motors at 50 Hz and 60 Hz				Article No.	Price per PU	Article No.	Price per PU
400 V	230 V	400 V	690 V	V					
A	kW	kW	kW						
<b>AC operation, 50/60 Hz</b>									
80	22	37	55	110 AC	3RA2345-8XB30-1AG2		--		
				230 AC	3RA2345-8XB30-1AL2		--		
95	22	45	75	110 AC	3RA2346-8XB30-1AG2		--		
				230 AC	3RA2346-8XB30-1AL2		--		
110	30	55	75	110 AC	3RA2347-8XB30-1AG2		--		
				230 AC	3RA2347-8XB30-1AL2		--		
<b>AC/DC operation</b>									
<b>With integrated coil circuit (varistor integrated in electronics at the factory)</b>									
80	22	37	55	20 ... 33 AC/DC	3RA2345-8XB30-1NB3		--		
95	22	45	75	20 ... 33 AC/DC	3RA2346-8XB30-1NB3		--		
110	30	55	75	20 ... 33 AC/DC	3RA2347-8XB30-1NB3		--		
<b>With voltage tap-off<sup>1)</sup></b>									
80	22	37	55	20 ... 33 AC/DC	3RA2345-8XE30-1NB3		--		
95	22	45	75	20 ... 33 AC/DC	3RA2346-8XE30-1NB3		--		
110	30	55	75	20 ... 33 AC/DC	3RA2347-8XE30-1NB3		--		

<sup>1)</sup> The associated module connectors 3RA2711-0EE17 for the 3RA271. function modules must be ordered separately, see page 3/102.

Representation of the complete reversing contactor assemblies with optionally mountable accessories, see page 3/147.



## Switching devices – Contactors and contactor assemblies – for switching motors

### Reversing contactor assemblies

#### Reversing contactor assemblies consisting of SIRIUS 3RT1 and 3TF6 contactors, up to 335 kW

##### Overview

The individual parts for the reversing contactor assemblies for customer assembly must be ordered separately.

- 3RT1 contactors (see page 3/64 onwards) and 3RT12 and 3TF6 vacuum contactors (see page 3/130 onwards):  
The operating times of the individual contactors are rated in such a way that no overlapping of the contact connection and the arcing time between two contactors can occur on reversing, provided they are interlocked by way of their auxiliary switches (NC contact interlock) and the mechanical interlock.  
For assemblies with AC operation and 50/60 Hz, a dead interval of 50 ms must be provided when used with voltages over 500 V; a dead interval of 30 ms is recommended for use with voltages up to and including 400 V. These dead times do not apply to assemblies with DC operation.  
The operating times of the individual contactors are not affected by the mechanical interlock.
- Mechanical interlocks
  - 3RT1 contactors: see page 3/108
  - 3TF68 vacuum contactors: Locking device for mechanical interlock, see page 3/135.
- Wiring kits consisting of wiring modules on the top and bottom
  - 3RT1 contactors: see page 3/104
  - 3TF68 vacuum contactors: see page 3/135
- Base plates
  - 3RT1 contactors: see page 3/113
  - 3TF68 vacuum contactors: see page 3/135

##### Additional components

- For momentary-contact operation: auxiliary switch (NO contact) for self-locking
- 3RB2 overload relays (see page 7/114 onwards), SIMOCODE pro 3UF7 motor management and control devices (see page 10/12 onwards) or 3RN2 thermistor motor protection relays (see page 10/136 onwards) can be used for overload protection.

##### More information

Homepage, see [www.siemens.com/sirius](http://www.siemens.com/sirius)

Industry Mall, see [www.siemens.com/product?3RA23\\_3RT1](http://www.siemens.com/product?3RA23_3RT1)

Guide of use for contactors in safety applications, see <https://support.industry.siemens.com/cs/ww/en/view/109807687>

# Switching devices – Contactors and contactor assemblies – for switching motors

## Reversing contactor assemblies

Reversing contactor assemblies consisting of SIRIUS 3RT1 and 3TF6 contactors, up to 335 kW

Reversing contactor assemblies for customer assembly · Size S6-S6 · Up to 90 kW

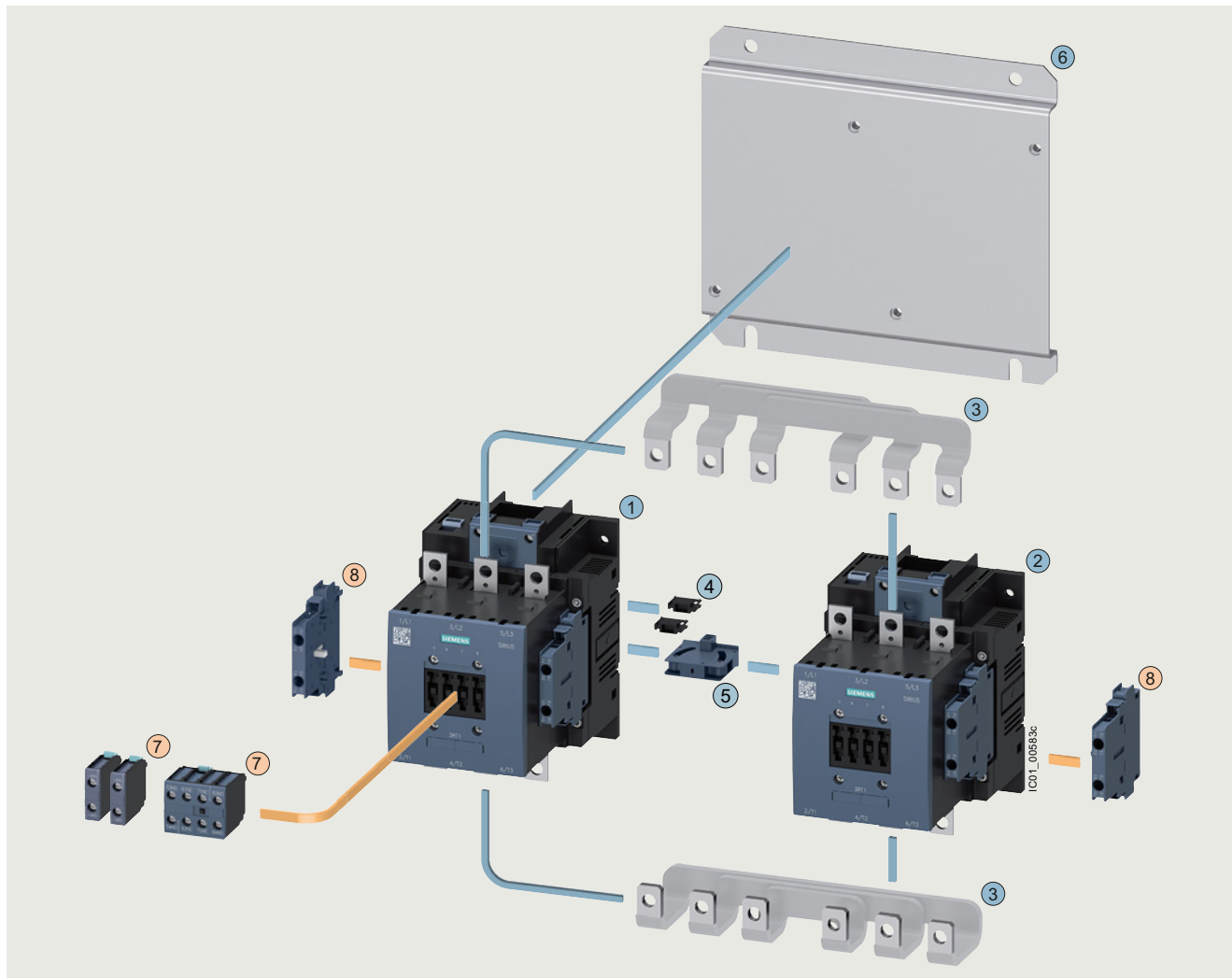

### Mountable accessories (optional)

To be ordered separately	Type	Page
⑦ Auxiliary switch, front	3RH1921	3/90
⑧ Auxiliary switch, lateral	3RH1921	3/92

### Reversing contactor assembly for customer assembly

Individual parts	Type		Page
	Q11	Q12	
① ② Contactors, 55 kW	3RT1054	3RT1054	3/64 ... 3/66
① ② Contactors, 75 kW	3RT1055	3RT1055	3/64 ... 3/66
① ② Contactors, 90 kW	3RT1056	3RT1056	3/64 ... 3/66
③ Assembly kit consisting of: Wiring modules on the top and bottom for contactors without box terminals for connecting the main and auxiliary circuits, electrical interlock included (NC contact interlock)	3RA1953-2A		3/104
④ Two connectors for two contactors	3RA1932-2D		3/108
⑤ Mechanical interlock	3RA1954-2A		3/108
⑥ Base plate for reversing contactor assemblies	3RA1952-2A		3/113

# Switching devices – Contactors and contactor assemblies – for switching motors

## Reversing contactor assemblies

Reversing contactor assemblies consisting of SIRIUS 3RT1 and 3TF6 contactors, up to 335 kW

Reversing contactor assemblies for customer assembly · Size S10-S10 · Up to 160 kW

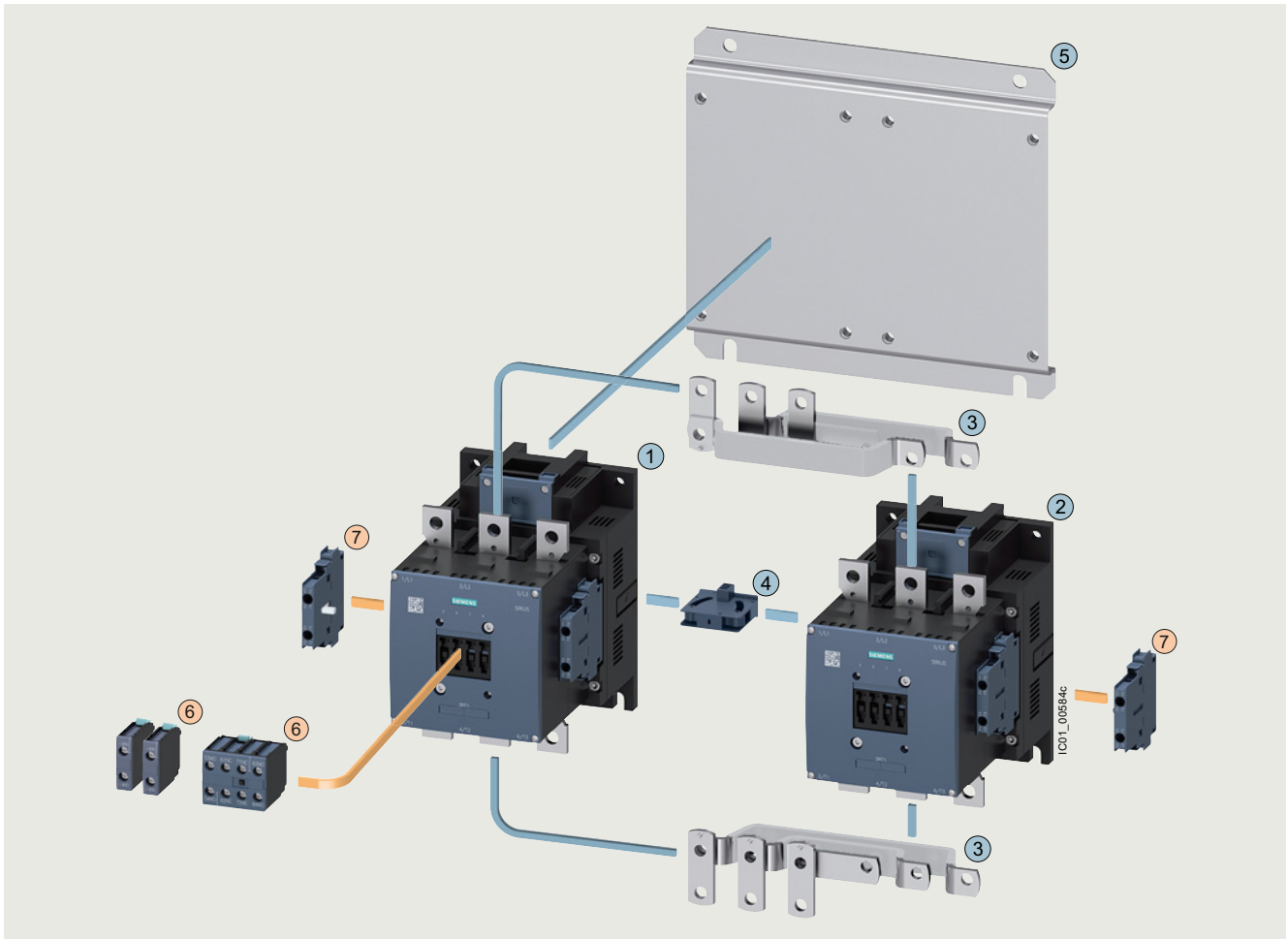

### Mountable accessories (optional)

To be ordered separately	Type	Page
⑥ Auxiliary switch, front	3RH1921	3/90
⑦ Auxiliary switch, lateral	3RH1921	3/92

### Reversing contactor assembly for customer assembly

Individual parts	Type		Page
	Q11	Q12	
①② Contactors, 110 kW	3RT1.64	3RT1.64	3/64 ... 3/66, 3/130
①② Contactors, 132 kW	3RT1.65	3RT1.65	3/64 ... 3/66, 3/130
①② Contactors, 160 kW	3RT1.66	3RT1.66	3/64 ... 3/66, 3/130
③ Assembly kit consisting of: Wiring modules on the top and bottom for contactors without box terminals for connecting the main and auxiliary circuits, electrical interlock included (NC contact interlock)	3RA1963-2A		3/104
④ Mechanical interlock	3RA1954-2A		3/108
⑤ Base plate for reversing contactor assemblies	3RA1962-2A		3/113

## Switching devices – Contactors and contactor assemblies – for switching motors

### Reversing contactor assemblies

Reversing contactor assemblies consisting of SIRIUS 3RT1 and 3TF6 contactors, up to 335 kW

Reversing contactor assemblies for customer assembly · Size S12-S12 · Up to 250 kW

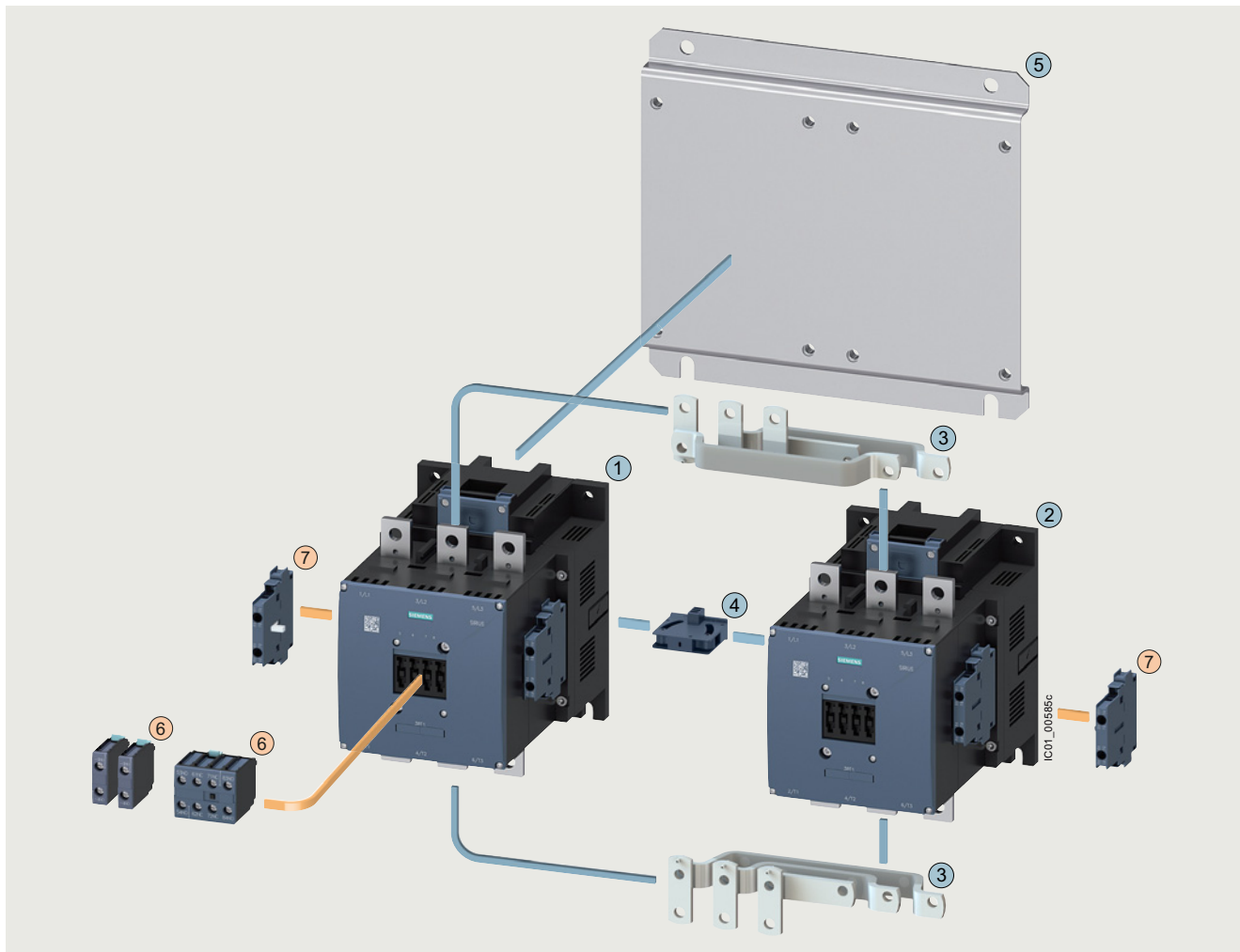

#### Mountable accessories (optional)

To be ordered separately	Type	Page
⑥ Auxiliary switch, front	3RH1921	3/90
⑦ Auxiliary switch, lateral	3RH1921	3/92

#### Reversing contactor assembly for customer assembly

Individual parts	Type		Page
	Q11	Q12	
①② Contactors, 200 kW	3RT1.75	3RT1.75	3/64 ... 3/66, 3/130
①② Contactors, 250 kW	3RT1.76	3RT1.76	3/64 ... 3/66, 3/130
③ Assembly kit consisting of: Wiring modules on the top and bottom for contactors without box terminals for connecting the main and auxiliary circuits, electrical interlock included (NC contact interlock)	3RA1973-2A		3/104
④ Mechanical interlock	3RA1954-2A		3/108
⑤ Base plate for reversing contactor assemblies	3RA1972-2A		3/113

## Switching devices – Contactors and contactor assemblies – for switching motors

### Reversing contactor assemblies

Reversing contactor assemblies consisting of SIRIUS 3RT1 and 3TF6 contactors, up to 335 kW

Reversing contactor assemblies for customer assembly · Size 14-14 · Up to 335 kW

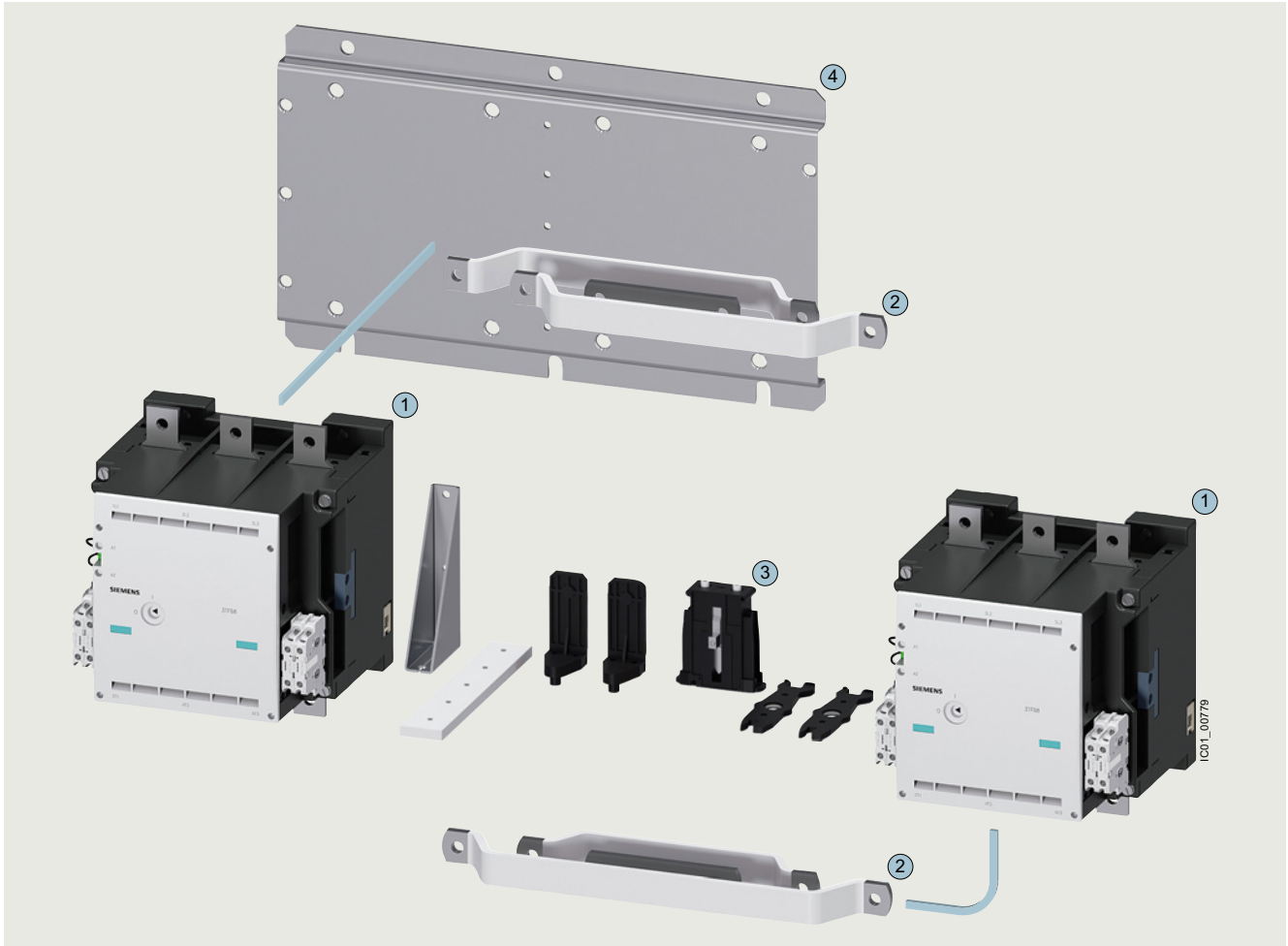

#### Reversing contactor assembly for customer assembly

Individual parts	Type	Q11	Q12	Page
① Vacuum contactors, 335 kW	3TF68		3TF68	3/131, 3/132
② Assembly kit consisting of: Wiring modules on the top and bottom for connecting the main and auxiliary circuits, electrical interlock included (NC contact interlock)	3TX7680-1A			3/135
③ Locking device for mechanical interlock	3TX7686-1A			3/135
④ Base plate for reversing contactor assemblies	3TX7681-1A			3/135

## Switching devices – Contactors and contactor assemblies – for switching motors

### Contactors assemblies for star-delta (wye-delta) starting

#### SIRIUS 3RA24 contactor assemblies for star-delta (wye-delta) starting, up to 90 kW

#### Overview

##### More information

Homepage, see [www.siemens.com/sirius](http://www.siemens.com/sirius)

Industry Mall, see [www.siemens.com/product?3RA24\\_3RT](http://www.siemens.com/product?3RA24_3RT)

Conversion tool, see [www.siemens.com/conversion-tool](http://www.siemens.com/conversion-tool)

TIA Selection Tool Cloud (TST Cloud), see [www.siemens.com/tstcloud/?node=LoadFeeder](http://www.siemens.com/tstcloud/?node=LoadFeeder)

Guide of use for contactors in safety applications, see <https://support.industry.siemens.com/cs/ww/en/view/109807687>

The 3RA24 contactor assemblies for star-delta (wye-delta) starting in sizes S00 to S3 can be ordered as follows:

- Fully wired and tested, with electrical and mechanical interlock, see [page 3/167 onwards](#).
- For all individual parts for customer assembly, see [page 3/69 onwards](#).

The 3RA24 contactor assemblies for star-delta (wye-delta) starting have screw terminals or spring-loaded terminals and are suitable for screw fixing and snap-on mounting on TH 35 DIN rails.

A base plate is also available for the size S2 and S3 assemblies.

A dead interval of 50 ms on reversing is already integrated in the 3RA28 function module for star-delta (wye-delta) starting.

With the fully wired and tested 3RA24 contactor assemblies for star-delta (wye-delta) starting, the auxiliary contacts included in the basic units are unassigned.

The 3RA24 contactor assemblies for star-delta (wye-delta) starting are designed for standard applications.

##### Note:

Contactors assemblies for star-delta (wye-delta) starting in special applications such as very heavy starting<sup>1)</sup> or star-delta (wye-delta) starting of special motors must be customized. Help with designing such special applications is available from our Technical Support, [www.siemens.com/support-request](http://www.siemens.com/support-request).

<sup>1)</sup> For effective assistance from Technical Support, you must provide the following details:

- Rated motor voltage,
- Rated motor current,
- Service factor, operating values
- Motor starting current factor
- Starting time
- Ambient temperature

##### Surge suppression

Surge suppression (varistor) is included in the 3RA28 function modules for star-delta (wye-delta) starting.

##### Motor protection

3RU2 overload relays (see [page 7/89 onwards](#)) or 3RB3 overload relays (see [page 7/102 onwards](#)) for contactor mounting or stand-alone installation, SIMOCODE pro 3UF7 motor management and control devices (see [page 10/12 onwards](#)) or 3RN2 thermistor motor protection relays (see [page 10/136 onwards](#)) can be used for motor protection.

The overload relay can either be mounted on the line contactor or fitted separately. It must be set to 0.58 times the rated motor current.

##### SIRIUS 3RA28 function module for star-delta (wye-delta) starting

The 3RA2816-0EW20 star-delta (wye-delta) function module (see [page 3/100](#)) replaces the complete wiring in the control circuit and can be used in the voltage range from 24 to 240 V AC/DC. It is snapped onto the front of the contactor assembly for star-delta (wye-delta) starting size S00, S0, S2 or S3.

One function module comprises a complete module kit:

- Basic module with integrated control logic and time setting
- Two coupling modules with corresponding connecting cables

The scope of supply thus comprises a complete module kit for one contactor assembly for star-delta (wye-delta) starting in size S00, S0, S2 or S3, regardless of the connection method.

Data of the control circuit:

- Wide voltage range 24 to 240 V AC/DC
- Time setting range 0.5 to 60 s (3 selectable settings)
- Dead interval of 50 ms, non-adjustable

## Switching devices – Contactors and contactor assemblies – for switching motors



### Contactor assemblies for star-delta (wye-delta) starting

#### SIRIUS 3RA24 contactor assemblies for star-delta (wye-delta) starting, up to 90 kW

#### Complete units

##### Note:

The selection of contactor types refers to fused designs.

Rated data at 50 Hz 400 V AC			Size	Type		Fully wired and tested contactor assemblies for star-delta (wye-delta) starting
Rating <i>P</i> kW	Operational current <i>I<sub>e</sub></i> A	Motor current A		Line/delta contactor	Star contactor	
 <b>Screw terminals</b>						
5.5	12	9.5 ... 13.8	<b>S00-S00-S00</b>	3RT2015-1...	3RT2015-1...	<b>3RA2415-8XF31-1...</b>
7.5	16	12.1 ... 17		3RT2017-1...	3RT2015-1...	<b>3RA2416-8XF31-1...</b>
11	25	19 ... 25		3RT2018-1...	3RT2016-1...	<b>3RA2417-8XF31-1...</b>
11	25	19 ... 25	<b>S0-S0-S0</b>	3RT2024-1...0	3RT2024-1...0	<b>3RA2423-8XF32-1...</b>
15	32	24.1 ... 34		3RT2026-1...0	3RT2024-1...0	<b>3RA2425-8XF32-1...</b>
18.5	40	34.5 ... 40		3RT2026-1...0	3RT2024-1...0	<b>3RA2425-8XF32-1...</b>
22	50	31 ... 43		3RT2027-1...0	3RT2026-1...0	<b>3RA2426-8XF32-1...</b>
22/30	50	31 ... 43	<b>S2-S2-S0</b>	3RT2035-1...0	3RT2026-1...0	<b>3RA2434-8XF32-1...</b>
37	80	62.1 ... 77.8		3RT2035-1...0	3RT2027-1...0	<b>3RA2435-8XF32-1...</b>
45	86	69 ... 86		3RT2036-1...0	3RT2028-1...0	<b>3RA2436-8XF32-1...</b>
55	115	77.6 ... 108.6	<b>S2-S2-S2</b>	3RT2037-1...0	3RT2035-1...0	<b>3RA2437-8XF32-1...</b>
55	115	77.6 ... 108.6	<b>S3-S3-S2</b>	3RT2045-1...0	3RT2035-1...0	<b>3RA2444-8XF32-1...</b>
75	150	120.7 ... 150		3RT2045-1...0	3RT2036-1...0	<b>3RA2445-8XF32-1...</b>
90	160	86 ... 160		3RT2046-1...0	3RT2037-1...0	<b>3RA2446-8XF32-1...</b>
 <b>Spring-loaded terminals</b>						
5.5	12	9.5 ... 13.8	<b>S00-S00-S00</b>	3RT2015-2...	3RT2015-2...	<b>3RA2415-8XF31-2...</b>
7.5	16	12.1 ... 17		3RT2017-2...	3RT2015-2...	<b>3RA2416-8XF31-2...</b>
11	25	19 ... 25		3RT2018-2...	3RT2016-2...	<b>3RA2417-8XF31-2...</b>
11	25	19 ... 25	<b>S0-S0-S0</b>	3RT2024-2...0	3RT2024-2...0	<b>3RA2423-8XF32-2...</b>
15	32	24.1 ... 34		3RT2026-2...0	3RT2024-2...0	<b>3RA2425-8XF32-2...</b>
18.5	40	34.5 ... 40		3RT2026-2...0	3RT2024-2...0	<b>3RA2425-8XF32-2...</b>
22	50	31 ... 43		3RT2027-2...0	3RT2026-2...0	<b>3RA2426-8XF32-2...</b>

#### Article number scheme

Product versions	Article number
<b>SIRIUS contactor assembly for star-delta (wye-delta) starting</b>	<b>3RA24</b> <input type="checkbox"/> <input type="checkbox"/> - <input type="checkbox"/> <input type="checkbox"/> <input type="checkbox"/> <input type="checkbox"/> - <input type="checkbox"/> <input type="checkbox"/> <input type="checkbox"/> <input type="checkbox"/>
Size of the contactor	e.g. 4 = S3 <input type="checkbox"/>
Rating dependent on size	e.g. 5 = 75 kW for size S3 <input type="checkbox"/>
Type of overload relay	e.g. 8X = Without <input type="checkbox"/> <input type="checkbox"/>
Assembly	e.g. F = Ready-assembled with function modules <input type="checkbox"/>
Interlock	e.g. 3 = Mechanical and electrical <input type="checkbox"/>
Free auxiliary switches	e.g. 2 = S3: 3 NO + 3 NC total <input type="checkbox"/>
Type of electrical connection	e.g. 1 = Screw terminals (main and auxiliary circuits) <input type="checkbox"/>
Operating range/solenoid coil circuit	e.g. A = AC standard/without coil circuit <input type="checkbox"/>
Rated control supply voltage	e.g. L2 = 230 V AC, 50/60 Hz <input type="checkbox"/> <input type="checkbox"/>
Example	<b>3RA24 4 5 - 8 X F 3 2 - 1 A L 2</b>

##### Note:

The article number scheme shows an overview of product versions for better understanding of the logic behind the article numbers.

For your orders, please use the article numbers quoted in the selection and ordering data.

## Switching devices – Contactors and contactor assemblies – for switching motors

### Contactors assemblies for star-delta (wye-delta) starting

#### SIRIUS 3RA24 contactor assemblies for star-delta (wye-delta) starting, up to 90 kW

#### Fully wired and tested contactor assemblies for star-delta (wye-delta) starting · Size S00-S00-S00 · Up to 11 kW

The figure shows the version with screw terminals

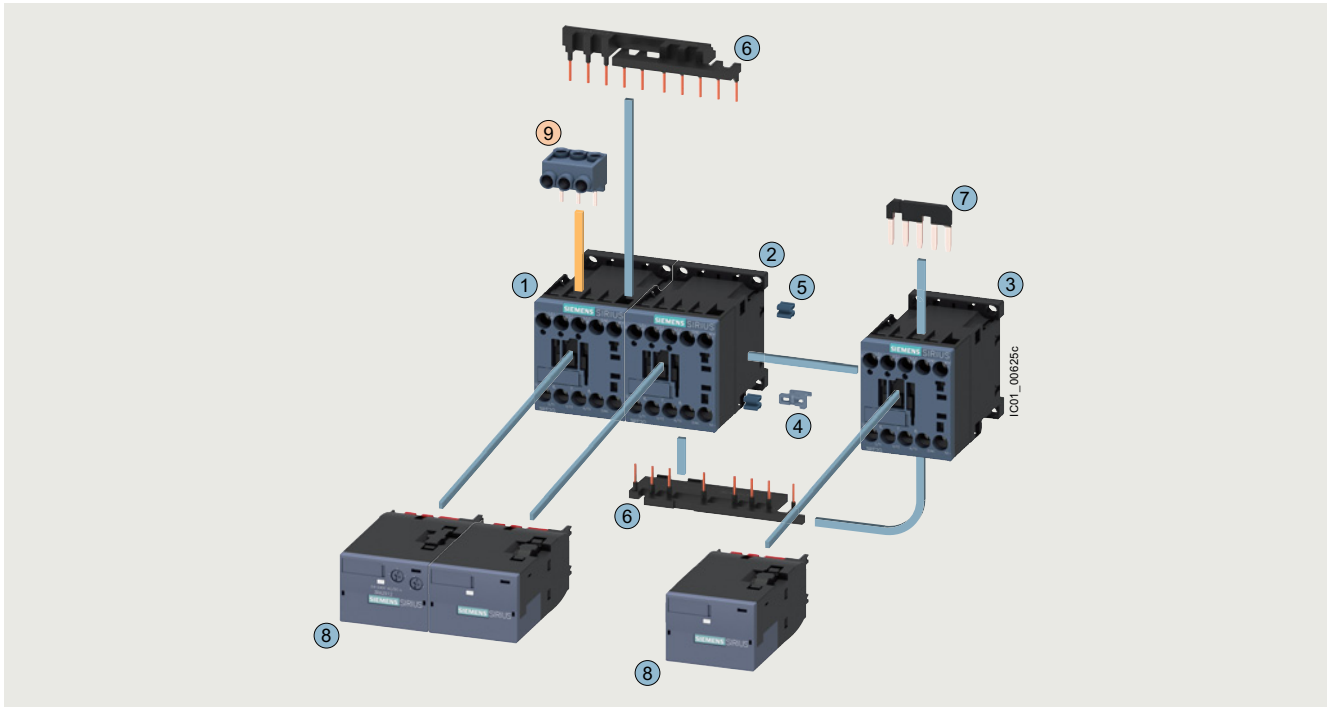

#### Mountable accessories (optional)

To be ordered separately	Type	Page
⑨ 3-phase infeed terminal <sup>1)</sup>	3RA2913-3K	3/110

#### Complete contactor assembly for star-delta (wye-delta) starting

Individual parts	Type			Page
	Q11 <sup>2)</sup>	Q13	Q12	
①②③ Contactors, 5.5 kW	3RT2015	3RT2015	3RT2015	3/47, 3/52
①②③ Contactors, 7.5 kW	3RT2017	3RT2017	3RT2015	3/47, 3/52
①②③ Contactors, 11 kW	3RT2018	3RT2018	3RT2016	3/47, 3/52
④ ... ⑦ Assembly kit S00-S00-S00 comprising:	3RA2913-2BB1			3/105
④ Mechanical interlock				
⑤ Four connecting clips for three contactors				
⑥ Wiring modules on top and bottom for connecting the main and auxiliary circuits				
⑦ Star jumper				
⑧ Function modules for star-delta (wye-delta) starting	3RA2816-0EW20			3/100

<sup>1)</sup> Part ⑨ can only be mounted for contactors with screw terminals.

<sup>2)</sup> The version with 1 NO is required for momentary-contact operation.

Complete contactor assemblies for star-delta (wye-delta) starting, see page 3/167.



## Switching devices – Contactors and contactor assemblies – for switching motors

### Contactor assemblies for star-delta (wye-delta) starting

SIRIUS 3RA24 contactor assemblies for star-delta (wye-delta) starting, up to 90 kW

**Fully wired and tested contactor assemblies for star-delta (wye-delta) starting · Size S0-S0-S0 · Up to 22 kW**

The figure shows the version with screw terminals

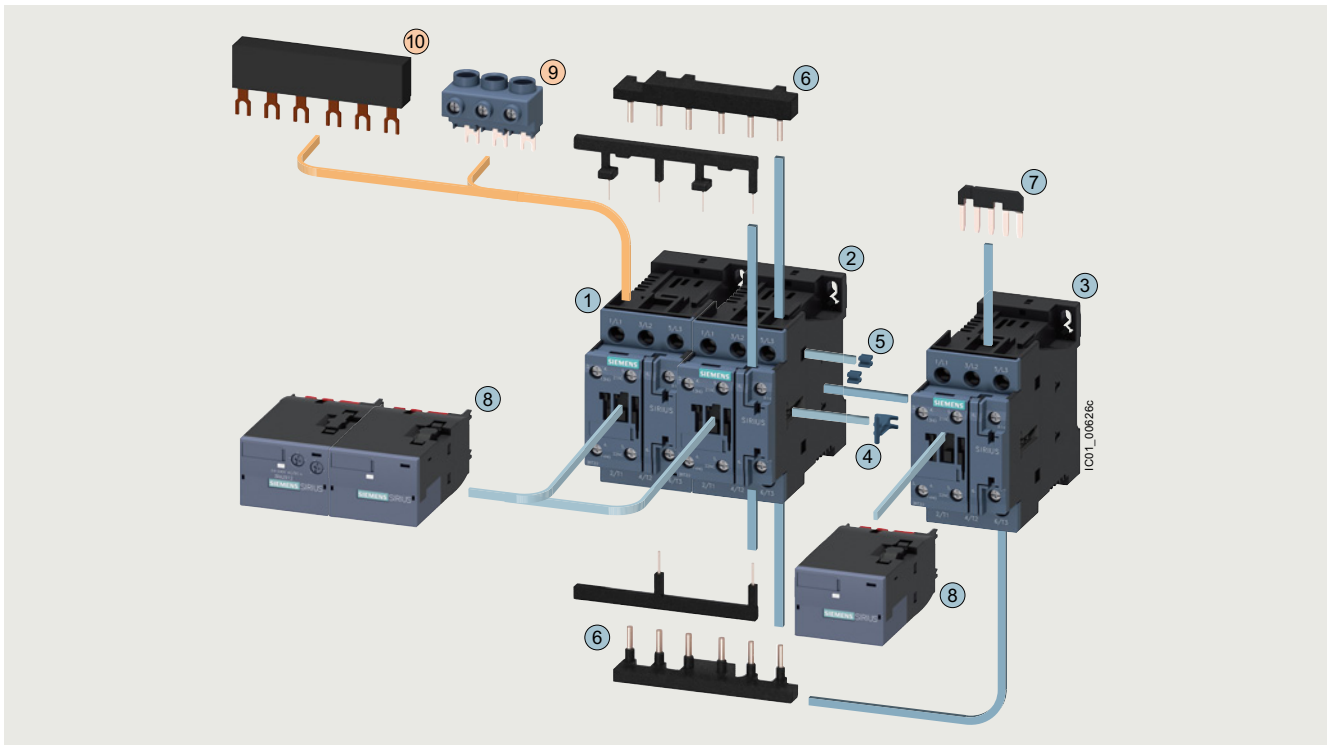

#### Mountable accessories (optional)

To be ordered separately	Type	Page
⑨ 3-phase infeed terminal <sup>1)</sup>	3RV2925-5AB	3/110
⑩ 3-phase busbar <sup>1)</sup>	3RV1915-1AB	3/110

#### Complete contactor assembly for star-delta (wye-delta) starting

Individual parts	Type			Page
	Q11	Q13	Q12	
①②③ Contactors, 11 kW	3RT2024	3RT2024	3RT2024	3/48, 3/56
①②③ Contactors, 15/18.5 kW	3RT2026	3RT2026	3RT2024	3/48, 3/56
①②③ Contactors, 22 kW	3RT2027	3RT2027	3RT2026	3/48, 3/56
④ ... ⑦ Assembly kit S0-S0-S0 comprising:	3RA2923-2BB1			3/105
④ Mechanical interlock				
⑤ Four connecting clips for three contactors				
⑥ Wiring modules on top and bottom for connecting the main and auxiliary circuits				
⑦ Star jumper				
⑧ Function modules for star-delta (wye-delta) starting	3RA2816-0EW20			3/100

<sup>1)</sup> The parts ⑨ and ⑩ can only be mounted for contactors with screw terminals, the wiring modules ⑥ must be removed beforehand.

Complete contactor assemblies for star-delta (wye-delta) starting, see page 3/168.

## Switching devices – Contactors and contactor assemblies – for switching motors

### Contactor assemblies for star-delta (wye-delta) starting

#### SIRIUS 3RA24 contactor assemblies for star-delta (wye-delta) starting, up to 90 kW

**Fully wired and tested contactor assemblies for star-delta (wye-delta) starting · Size S2-S2-S0<sup>1)</sup> · Up to 45 kW and S2-S2-S2 · 55 kW**

The figure shows the version with screw terminals in S2-S2-S2

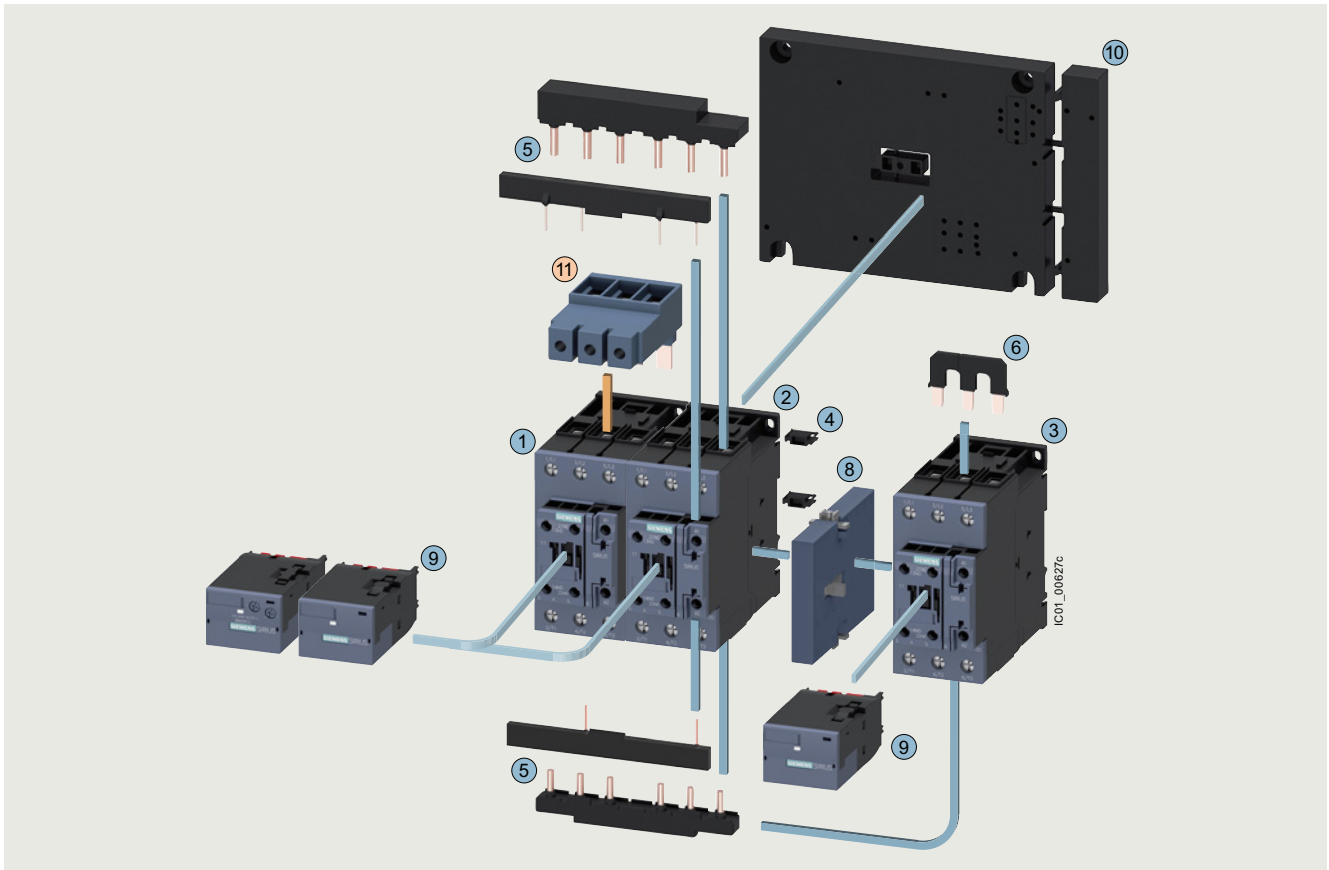

#### Mountable accessories (optional)

To be ordered separately	Type	Page
⑪ 3-phase infeed terminal	3RV2935-5A	3/110

#### Complete contactor assembly for star-delta (wye-delta) starting

Individual parts	Type			Page
	Q11	Q13	Q12	
① ② ③ Contactors, 22/30 kW	3RT2035	3RT2035	3RT2026	3/50, 3/61
① ② ③ Contactors, 37 kW	3RT2035	3RT2035	3RT2027	3/50, 3/61
① ② ③ Contactors, 45 kW	3RT2036	3RT2036	3RT2028	3/50, 3/61
① ② ③ Contactors, 55 kW	3RT2037	3RT2037	3RT2035	3/50, 3/61
④ ... ⑦ Assembly kit S2-S2-S2 comprising:	3RA2933-2BB1			3/105
④ Four connectors for three contactors (not required for fully pre-wired contactor assemblies for star-delta (wye-delta) starting)				
⑤ Wiring modules on top and bottom for connecting the main and auxiliary circuits				
⑥ Star jumper S2				
⑦ Cable for connecting the A2 coil contact of the line contactor with the A2 coil contact of the delta contactor (not shown in the drawing)				
⑧ Mechanical interlock	3RA2934-2B			3/108
⑨ Function modules for star-delta (wye-delta) starting	3RA2816-0EW20			3/100
⑩ Base plate star-delta (wye-delta)	3RA2932-2F			3/113

<sup>1)</sup> Complete contactor assembly for star-delta (wye-delta) starting in size S2-S2-S0 (not shown): The 3RA2933-2C assembly kit is to be used here, see page 3/105.

Complete contactor assemblies for star-delta (wye-delta) starting, see page 3/169.

## Switching devices – Contactors and contactor assemblies – for switching motors

### Contactor assemblies for star-delta (wye-delta) starting

SIRIUS 3RA24 contactor assemblies for star-delta (wye-delta) starting, up to 90 kW

Fully wired and tested contactor assemblies for star-delta (wye-delta) starting · Size S3-S3-S2<sup>1)</sup> · Up to 90 kW

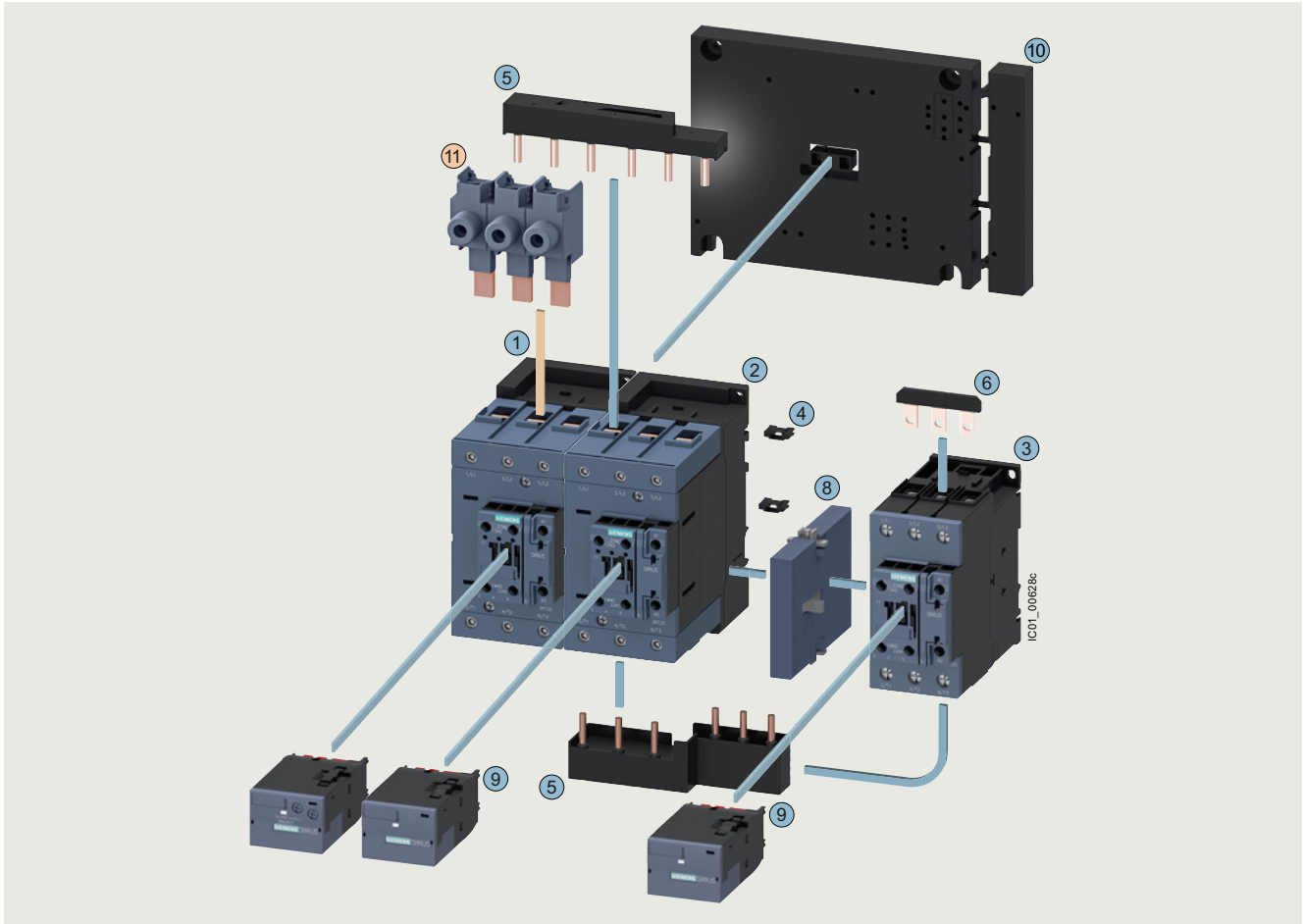

#### Mountable accessories (optional)

To be ordered separately	Type	Page
⑪ 1-phase infeed terminal (three units are required)	3RA2943-3L	3/110

#### Complete contactor assembly for star-delta (wye-delta) starting

Individual parts	Type			Page
	Q11	Q13	Q12	
①②③ Contactors, 55 kW	3RT2045	3RT2045	3RT2035	3/51, 3/63
①②③ Contactors, 75 kW	3RT2045	3RT2045	3RT2036	3/51, 3/63
①②③ Contactors, 90 kW	3RT2046	3RT2046	3RT2037	3/51, 3/63
④ ... ⑦ Assembly kit S3-S3-S2 comprising:	3RA2943-2C			3/105
④ Two connectors for three contactors (not required for fully pre-wired contactor assemblies for star-delta (wye-delta) starting)				
⑤ Wiring modules on top and bottom (S3-S2) for connecting the main and auxiliary circuits and a cable set for the auxiliary circuit				
⑥ Star jumper S2				
⑦ Cable for connecting the A2 coil contact of the line contactor with the A2 coil contact of the delta contactor (not shown in the drawing)				
⑧ Mechanical interlock	3RA2934-2B			3/108
⑨ Function modules for star-delta (wye-delta) starting	3RA2816-0EW20			3/100
⑩ Base plate star-delta (wye-delta)	3RA2942-2F			3/113

<sup>1)</sup> Contactor assembly for star-delta (wye-delta) starting for customer assembly in size S3-S3-S3 (not shown): The 3RA2943-2BB assembly kit is to be used here, see page 3/105.

Complete contactor assemblies for star-delta (wye-delta) starting, see page 3/170.

## Switching devices – Contactors and contactor assemblies – for switching motors

### Contactor assemblies for star-delta (wye-delta) starting

#### SIRIUS 3RA24 contactor assemblies for star-delta (wye-delta) starting, up to 90 kW

#### Technical specifications

##### More information

Technical specifications, see <https://support.industry.siemens.com/cs/ww/en/ps/16150/td>  
 FAQs, see <https://support.industry.siemens.com/cs/ww/en/ps/16150/faq>  
 System Manual for modular system, see <https://support.industry.siemens.com/cs/ww/en/view/60311318>

Equipment Manual, see <https://support.industry.siemens.com/cs/ww/en/view/60306557>  
 Application Manual - Switching devices with IE3 and IE4 motors, see <https://support.industry.siemens.com/cs/ww/en/view/94770820>  
 Guide of use for contactors in safety applications, see <https://support.industry.siemens.com/cs/ww/en/view/109807687>

Unless otherwise indicated below, the technical specifications correspond to those of the 3RT individual contactors (see page 3/25 onwards) and 3RU2 overload relays (see page 7/85 onwards).

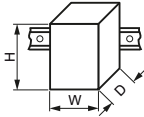
Type		3RA2415	3RA2416	3RA2417	3RA2423	3RA2425	3RA2426
Sizes		S00-S00-S00	S00-S00-S00	S00-S00-S00	S0-S0-S0	S0-S0-S0	S0-S0-S0
<b>General data</b>							
<b>Dimensions (W x H x D) with function module</b>							
<ul style="list-style-type: none"> <li>AC operation</li> <li>- Screw terminals</li> <li>- Spring-loaded terminals</li> <li>DC operation</li> <li>- Screw terminals</li> <li>- Spring-loaded terminals</li> </ul>		mm	135 x 68 x 145		135 x 101 x 171		
		mm	135 x 84 x 145		135 x 114 x 171		
		mm	135 x 68 x 145		135 x 101 x 181		
		mm	135 x 84 x 145		135 x 114 x 181		
<b>Individual contactors</b>							
• Q11 line contactor	Type	3RT2015	3RT2017	3RT2018	3RT2024	3RT2026	3RT2027
• Q13 delta contactor	Type	3RT2015	3RT2017	3RT2018	3RT2024	3RT2026	3RT2027
• Q12 star contactor	Type	3RT2015	3RT2015	3RT2016	3RT2024	3RT2024	3RT2026
<b>Mechanical endurance</b>							
	Operating cycles	3 million					
<b>Unassigned auxiliary contacts of the individual contactors</b>							
For circuit diagrams of the control circuit, see <a href="#">Equipment Manual for contactors/contacter assemblies</a>							
<b>Short-circuit protection</b>							
<b>Main circuit without overload relays</b>							
Fuse links, operational class gG: LV HRC, type 3NA; DIAZED, type 5SB; NEOZED, type 5SE with single or double infeed							
• Highest rated current of the fuse according to IEC 60947-4-1							
- Type of coordination "1"	A	35		63		100	125
- Type of coordination "2"	A	20		25		35	63
<b>Auxiliary circuit</b>							
Short-circuit test							
• With fuse links, operational class gG: DIAZED, type 5SB; NEOZED, type 5SE with short-circuit current $I_k = 1$ kA according to IEC 60947-5-1	A	10	6 (up to $I_k < 0.5$ kA; $\leq 260$ V), if the auxiliary contact of the overload relay is connected in the contactor coil circuit				
• With miniature circuit breaker, C characteristic with short-circuit current $I_k = 400$ A	A	10	6 (up to $I_k < 0.5$ kA; $\leq 260$ V), if the auxiliary contact of the overload relay is connected in the contactor coil circuit				
Short-circuit protection with overload relay							
See <a href="#">Configuration Manual for load feeders</a>							

## Switching devices – Contactors and contactor assemblies – for switching motors

### Contactor assemblies for star-delta (wye-delta) starting

#### SIRIUS 3RA24 contactor assemblies for star-delta (wye-delta) starting, up to 90 kW

Type		3RA2415	3RA2416	3RA2417	3RA2423	3RA2425	3RA2426
Sizes		S00-S00-S00	S00-S00-S00	S00-S00-S00	S0-S0-S0	S0-S0-S0	S0-S0-S0
<b>Rated data of the main contacts</b>							
<b>Current-carrying capacity with reversing time up to 10 s</b>							
• Rated operational current $I_e$	at 400 V	A	12	17	25	40	55
	690 V	A	6.9	9	20.8	22.5	35
• Rated power for three-phase motors at 50 Hz and 60 Hz	at 230 V	kW	3.3	4.7	7.2	12	16.6
	400 V	kW	5.8	8.2	12.5	21	30.1
	690 V	kW	5.8	7.5	18	20.4	33
• <b>Switching frequency</b> with overload relay		1/h	15				
<b>Current-carrying capacity with reversing time up to 15 s</b>							
• Rated operational current $I_e$	at 400 V	A	12	17	25	31	44
	690 V	A	6.9	9	20.8	22.5	35
• Rated power for three-phase motors at 50 Hz and 60 Hz	at 230 V	kW	3.3	4.7	7.2	9.4	13.8
	400 V	kW	5.8	8.2	12.5	16.3	24
	690 V	kW	5.8	7.5	18	20.4	33
• <b>Switching frequency</b> with overload relay		1/h	15				
<b>Current-carrying capacity with reversing time up to 20 s</b>							
• Rated operational current $I_e$	at 400 V	A	12	17	25	28	39
	690 V	A	6.9	9	20.8	22.5	35
• Rated power for three-phase motors at 50 Hz and 60 Hz	at 230 V	kW	3.3	4.7	7.2	8.5	12.2
	400 V	kW	5.8	8.2	12.5	14.7	21.3
	690 V	kW	5.8	7.5	18	20.4	33
• <b>Switching frequency</b> with overload relay		1/h	15				

## Switching devices – Contactors and contactor assemblies – for switching motors

### Contactor assemblies for star-delta (wye-delta) starting

#### SIRIUS 3RA24 contactor assemblies for star-delta (wye-delta) starting, up to 90 kW

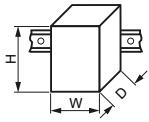
Type		3RA2434	3RA2435	3RA2436	3RA2437	3RA2444	3RA2445	3RA2446	
Sizes		S2-S2-S0	S2-S2-S0	S2-S2-S0	S2-S2-S2	S3-S3-S2	S3-S3-S2	S3-S3-S2	
<b>General data</b>									
<b>Dimensions (W x H x D) with function module</b>									
<ul style="list-style-type: none"> <li>AC and DC operation</li> <li>Screw terminals</li> </ul>									
mm		177.5 x 142 x 223				220 x 180 x 244			
<b>Individual contactors</b>									
• Q11 line contactor		Type	3RT2035	3RT2035	3RT2036	3RT2037	3RT2045	3RT2045	3RT2046
• Q13 delta contactor		Type	3RT2035	3RT2035	3RT2036	3RT2037	3RT2045	3RT2045	3RT2046
• Q12 star contactor		Type	3RT2026	3RT2027	3RT2028	3RT2035	3RT2035	3RT2036	3RT2037
<b>Mechanical endurance</b>		Operating cycles	1 million						
<b>Unassigned auxiliary contacts of the individual contactors</b>		For circuit diagrams of the control circuit, see <a href="#">Equipment Manual</a> .							
<b>Short-circuit protection</b>									
<b>Main circuit without overload relays</b>									
Fuse links, operational class gG: LV HRC, type 3NA; DIAZED, type 5SB; NEOZED, type 5SE with single or double infeed									
• Highest rated current of the fuse according to IEC 60947-4-1									
- Type of coordination "1"		A	160		250				
- Type of coordination "2"		A	80		125	160			
<b>Auxiliary circuit</b>									
Short-circuit test									
• With fuse links, operational class gG: DIAZED, type 5SB; NEOZED, type 5SE with short-circuit current $I_k = 1$ kA according to IEC 60947-5-1		A	10						
		A	6 (up to $I_k < 0.5$ kA; $\leq 260$ V), if the auxiliary contact of the overload relay is connected in the contactor coil circuit						
• With miniature circuit breaker, C characteristic with short-circuit current $I_k = 400$ A		A	10						
		A	6 (up to $I_k < 0.5$ kA; $\leq 260$ V), if the auxiliary contact of the overload relay is connected in the contactor coil circuit						
Short-circuit protection with overload relay		See <a href="#">Configuration Manual for load feeders</a>				On request			
<b>Rated data of the main contacts</b>									
<b>Current-carrying capacity with reversing time up to 10 s</b>									
• Rated operational current $I_e$		at 400 V	A	On request					
		690 V	A	On request					
• Rated power for three-phase motors at 50 Hz and 60 Hz		at 230 V	kW	On request					
		400 V	kW	On request					
		690 V	kW	On request					
• <b>Switching frequency</b> with overload relay		1/h	15						
<b>Current-carrying capacity with reversing time up to 15 s</b>									
• Rated operational current $I_e$		at 400 V	A	On request					
		690 V	A	On request					
• Rated power for three-phase motors at 50 Hz and 60 Hz		at 230 V	kW	On request					
		400 V	kW	On request					
		690 V	kW	On request					
• <b>Switching frequency</b> with overload relay		1/h	15						
<b>Current-carrying capacity with reversing time up to 20 s</b>									
• Rated operational current $I_e$		at 400 V	A	On request					
		690 V	A	On request					
• Rated power for three-phase motors at 50 Hz and 60 Hz		at 230 V	kW	On request					
		400 V	kW	On request					
		690 V	kW	On request					
• <b>Switching frequency</b> with overload relay		1/h	15						

## Switching devices – Contactors and contactor assemblies – for switching motors

### Contactor assemblies for star-delta (wye-delta) starting

**IE3/IE4 ready** SIRIUS 3RA24 contactor assemblies for star-delta (wye-delta) starting, up to 90 kW

#### Selection and ordering data

Fully wired and tested contactor assemblies for star-delta (wye-delta) starting · Size S00-S00-S00 · Up to 11 kW  
AC operation  or DC operation 



PU (UNIT, SET, M) = 1  
PS\* = 1 unit  
PG = 41B



3RA241.-8XF31-1A.0

3RA241.-8XF31-2A.0

3RA241.-8XE31-2BB4

Rated data AC-3				Rated control supply voltage $U_s$	Screw terminals 		Spring-loaded terminals 	
Operational current $I_e$ up to	Ratings of three-phase motors at 50 Hz and 60 Hz at				Article No.	Price per PU	Article No.	Price per PU
400 V	230 V	400 V	690 V	V				
A	kW	kW	kW					
<b>AC operation, 50/60 Hz</b>								
12	3.3	5.5	9.2	24 AC	3RA2415-8XF31-1AB0		3RA2415-8XF31-2AB0	
				110 AC	3RA2415-8XF31-1AF0		3RA2415-8XF31-2AF0	
				230 AC	3RA2415-8XF31-1AP0		3RA2415-8XF31-2AP0	
16	4.7	7.5	9.2	24 AC	3RA2416-8XF31-1AB0		3RA2416-8XF31-2AB0	
				110 AC	3RA2416-8XF31-1AF0		3RA2416-8XF31-2AF0	
				230 AC	3RA2416-8XF31-1AP0		3RA2416-8XF31-2AP0	
25	5.5	11	11	24 AC	3RA2417-8XF31-1AB0		3RA2417-8XF31-2AB0	
				110 AC	3RA2417-8XF31-1AF0		3RA2417-8XF31-2AF0	
				230 AC	3RA2417-8XF31-1AP0		3RA2417-8XF31-2AP0	
<b>DC operation</b>								
12	3.3	5.5	9.2	24 DC	3RA2415-8XF31-1BB4		3RA2415-8XF31-2BB4	
16	4.7	7.5	9.2	24 DC	3RA2416-8XF31-1BB4		3RA2416-8XF31-2BB4	
25	5.5	11	11	24 DC	3RA2417-8XF31-1BB4		3RA2417-8XF31-2BB4	
<b>For IO-Link connection</b>								
12	3.3	5.5	9.2	24 DC	3RA2415-8XE31-1BB4		3RA2415-8XE31-2BB4	
16	4.7	7.5	9.2	24 DC	3RA2416-8XE31-1BB4		3RA2416-8XE31-2BB4	
25	5.5	11	11	24 DC	3RA2417-8XE31-1BB4		3RA2417-8XE31-2BB4	
<b>For AS-Interface integration</b>								
12	3.3	5.5	9.2	24 DC	3RA2415-8XH31-1BB4		3RA2415-8XH31-2BB4	
16	4.7	7.5	9.2	24 DC	3RA2416-8XH31-1BB4		3RA2416-8XH31-2BB4	
25	5.5	11	11	24 DC	3RA2417-8XH31-1BB4		3RA2417-8XH31-2BB4	

Representation of the complete contactor assemblies for star-delta (wye-delta) starting with optionally mountable accessories, see page 3/160.





## Switching devices – Contactors and contactor assemblies – for switching motors

### Contactor assemblies for star-delta (wye-delta) starting

SIRIUS 3RA24 contactor assemblies for star-delta (wye-delta) starting, up to 90 kW

**IE3/IE4 ready**

**Fully wired and tested contactor assemblies for star-delta (wye-delta) starting · Size S0-S0-S0 · Up to 22 kW**

**AC operation**  **or DC operation** 



PU (UNIT, SET, M) = 1  
PS\* = 1 unit  
PG = 41B



3RA242.-8XF32-1A.2

3RA242.-8XE32-1BB4

3RA242.-8XF32-2A.2

Rated data AC-3				Rated control supply voltage $U_s$	Screw terminals 		Spring-loaded terminals 		
Operational current $I_e$ up to	Ratings of three-phase motors at 50 Hz and 60 Hz at				Article No.	Price per PU	Article No.	Price per PU	
	400 V	230 V	400 V	690 V					
A	kW	kW	kW	V					
<b>AC operation, 50/60 Hz</b>									
25	7.1	11	19	24 AC	3RA2423-8XF32-1AC2		3RA2423-8XF32-2AC2		
				110 AC	3RA2423-8XF32-1AG2		3RA2423-8XF32-2AG2		
				230 AC	3RA2423-8XF32-1AL2		3RA2423-8XF32-2AL2		
32/40	11.4	15/18.5	19	24 AC	3RA2425-8XF32-1AC2		3RA2425-8XF32-2AC2		
				110 AC	3RA2425-8XF32-1AG2		3RA2425-8XF32-2AG2		
				230 AC	3RA2425-8XF32-1AL2		3RA2425-8XF32-2AL2		
50	--	22	19	24 AC	3RA2426-8XF32-1AC2		3RA2426-8XF32-2AC2		
				110 AC	3RA2426-8XF32-1AG2		3RA2426-8XF32-2AG2		
				230 AC	3RA2426-8XF32-1AL2		3RA2426-8XF32-2AL2		
<b>DC operation</b>									
25	7.1	11	19	24 DC	3RA2423-8XF32-1BB4		3RA2423-8XF32-2BB4		
32/40	11.4	15/18.5	19	24 DC	3RA2425-8XF32-1BB4		3RA2425-8XF32-2BB4		
50	--	22	19	24 DC	3RA2426-8XF32-1BB4		3RA2426-8XF32-2BB4		
<b>For IO-Link connection</b>									
25	7.1	11	19	24 DC	3RA2423-8XE32-1BB4		3RA2423-8XE32-2BB4		
32/40	11.4	15/18.5	19	24 DC	3RA2425-8XE32-1BB4		3RA2425-8XE32-2BB4		
50	--	22	19	24 DC	3RA2426-8XE32-1BB4		3RA2426-8XE32-2BB4		
<b>For AS-Interface integration</b>									
25	7.1	11	19	24 DC	3RA2423-8XH32-1BB4		3RA2423-8XH32-2BB4		
32/40	11.4	15/18.5	19	24 DC	3RA2425-8XH32-1BB4		3RA2425-8XH32-2BB4		
50	--	22	19	24 DC	3RA2426-8XH32-1BB4		3RA2426-8XH32-2BB4		

Representation of the complete contactor assemblies for star-delta (wye-delta) starting with optionally mountable accessories, see page 3/161.



## Switching devices – Contactors and contactor assemblies – for switching motors

### Contactor assemblies for star-delta (wye-delta) starting

**IE3/IE4 ready** SIRIUS 3RA24 contactor assemblies for star-delta (wye-delta) starting, up to 90 kW

**Fully wired and tested contactor assemblies for star-delta (wye-delta) starting · Size S2-S2-S0 · Up to 45 kW and S2-S2-S2 · 55 kW**  
**AC operation**  or **AC/DC operation** 

PU (UNIT, SET, M) = 1  
 PS\* = 1 unit  
 PG = 41B

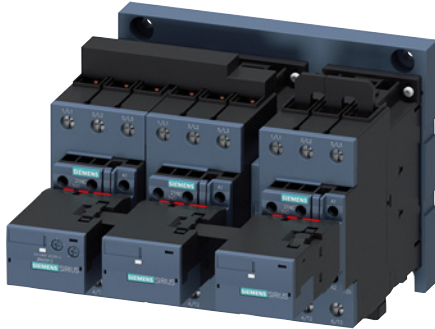

3RA2437-8XF32-1A.2

3RA2434-8XE32-1NB3

#### Rated data AC-3

Operational current $I_e$ up to 400 V	Ratings of three-phase motors at 50 Hz and 60 Hz at			Rated control supply voltage $U_s$
	230 V	400 V	690 V	
A	kW	kW	kW	V
50/65	19.6	<b>22/30</b>	34	24 AC 110 AC 230 AC
80	25	<b>37</b>	63	24 AC 110 AC 230 AC
86	27	<b>45</b>	63	24 AC 110 AC 230 AC
115	37	<b>55</b>	93	24 AC 110 AC 230 AC

#### Screw terminals

Article No. Price per PU

#### Spring-loaded terminals

Article No. Price per PU

#### AC operation, 50/60 Hz

Operational current $I_e$ up to 400 V	230 V	400 V	690 V	Rated control supply voltage $U_s$	Screw terminals	Spring-loaded terminals
50/65	19.6	<b>22/30</b>	34	24 AC 110 AC 230 AC	<b>3RA2434-8XF32-1AC2</b> <b>3RA2434-8XF32-1AG2</b> <b>3RA2434-8XF32-1AL2</b>	--
80	25	<b>37</b>	63	24 AC 110 AC 230 AC	<b>3RA2435-8XF32-1AC2</b> <b>3RA2435-8XF32-1AG2</b> <b>3RA2435-8XF32-1AL2</b>	--
86	27	<b>45</b>	63	24 AC 110 AC 230 AC	<b>3RA2436-8XF32-1AC2</b> <b>3RA2436-8XF32-1AG2</b> <b>3RA2436-8XF32-1AL2</b>	--
115	37	<b>55</b>	93	24 AC 110 AC 230 AC	<b>3RA2437-8XF32-1AC2</b> <b>3RA2437-8XF32-1AG2</b> <b>3RA2437-8XF32-1AL2</b>	--

#### AC/DC operation, 50/60 Hz AC or DC

**With integrated coil circuit**  
**(varistor integrated in electronics at the factory)**

Operational current $I_e$ up to 400 V	230 V	400 V	690 V	Rated control supply voltage $U_s$	Screw terminals	Spring-loaded terminals
50/65	19.6	<b>22/30</b>	34	20 ... 33 AC/DC	<b>3RA2434-8XF32-1NB3</b>	--
80	25	<b>37</b>	63	20 ... 33 AC/DC	<b>3RA2435-8XF32-1NB3</b>	--
86	27	<b>45</b>	63	20 ... 33 AC/DC	<b>3RA2436-8XF32-1NB3</b>	--
115	37	<b>55</b>	93	20 ... 33 AC/DC	<b>3RA2437-8XF32-1NB3</b>	--
<b>For IO-Link connection</b>						
50/65	19.6	<b>22/30</b>	34	20 ... 33 AC/DC	<b>3RA2434-8XE32-1NB3</b>	--
80	25	<b>37</b>	63	20 ... 33 AC/DC	<b>3RA2435-8XE32-1NB3</b>	--
86	27	<b>45</b>	63	20 ... 33 AC/DC	<b>3RA2436-8XE32-1NB3</b>	--
115	37	<b>55</b>	93	20 ... 33 AC/DC	<b>3RA2437-8XE32-1NB3</b>	--
<b>For AS-Interface integration</b>						
50/65	19.6	<b>22/30</b>	34	20 ... 33 AC/DC	<b>3RA2434-8XH32-1NB3</b>	--
80	25	<b>37</b>	63	20 ... 33 AC/DC	<b>3RA2435-8XH32-1NB3</b>	--
86	27	<b>45</b>	63	20 ... 33 AC/DC	<b>3RA2436-8XH32-1NB3</b>	--
115	37	<b>55</b>	93	20 ... 33 AC/DC	<b>3RA2437-8XH32-1NB3</b>	--

Representation of the complete contactor assemblies for star-delta (wye-delta) starting in size S2-S2-S2 with optionally mountable accessories, see page 3/162.

## Switching devices – Contactors and contactor assemblies – for switching motors

### Contactor assemblies for star-delta (wye-delta) starting

SIRIUS 3RA24 contactor assemblies for star-delta (wye-delta) starting, up to 90 kW

**IE3/IE4 ready**

**Fully wired and tested contactor assemblies for star-delta (wye-delta) starting · Size S3-S3-S2 · Up to 90 kW**

**AC operation**  or **AC/DC operation** 

PU (UNIT, SET, M) = 1  
PS\* = 1 unit  
PG = 41B



3RA244.-8XF32-1A.2

3RA244.-8XE32-1NB3

3RA244.-8XH32-1NB3

#### Rated data AC-3

Operational current  $I_e$  up to

400 V

A

Ratings of three-phase motors at 50 Hz and 60 Hz at

230 V

**400 V**

690 V

kW

**kW**

kW

kW

kW

kW

kW

kW

kW

kW

kW

kW

kW

kW

kW

kW

kW

kW

kW

kW

kW

kW

kW

kW

kW

kW

kW

kW

kW

kW

kW

kW

kW

kW

kW

kW

kW

kW

Rated control supply voltage  $U_s$

V

#### Screw terminals



Article No.

Price per PU

#### Spring-loaded terminals



Article No.

Price per PU

#### AC operation, 50/60 Hz

115

30

**55**

90

24 AC

110 AC

230 AC

**3RA2444-8XF32-1AC2**

**3RA2444-8XF32-1AG2**

**3RA2444-8XF32-1AL2**

--

--

--

150

37

**75**

110

24 AC

110 AC

230 AC

**3RA2445-8XF32-1AC2**

**3RA2445-8XF32-1AG2**

**3RA2445-8XF32-1AL2**

--

--

--

160

45

**90**

132

24 AC

110 AC

230 AC

**3RA2446-8XF32-1AC2**

**3RA2446-8XF32-1AG2**

**3RA2446-8XF32-1AL2**

--

--

--

#### AC/DC operation, 50/60 Hz AC or DC

##### With integrated coil circuit

(varistor integrated in electronics at the factory)

115

30

**55**

90

20 ... 33 AC/DC

**3RA2444-8XF32-1NB3**

--

150

37

**75**

110

20 ... 33 AC/DC

**3RA2445-8XF32-1NB3**

--

160

45

**90**

132

20 ... 33 AC/DC

**3RA2446-8XF32-1NB3**

--

##### For IO-Link connection

115

30

**55**

90

20 ... 33 AC/DC

**3RA2444-8XE32-1NB3**

--

150

37

**75**

110

20 ... 33 AC/DC

**3RA2445-8XE32-1NB3**

--

160

45

**90**

132

20 ... 33 AC/DC

**3RA2446-8XE32-1NB3**

--

##### For AS-Interface integration

115

30

**55**

90

20 ... 33 AC/DC

**3RA2444-8XH32-1NB3**

--

150

37

**75**

110

20 ... 33 AC/DC

**3RA2445-8XH32-1NB3**

--

160

45

**90**

132

20 ... 33 AC/DC

**3RA2446-8XH32-1NB3**

--

Representation of the complete contactor assemblies for star-delta (wye-delta) starting with optionally mountable accessories, see page 3/163.

## Switching devices – Contactors and contactor assemblies – for switching motors

### Contactor assemblies for star-delta (wye-delta) starting

Contactor assemblies for star-delta (wye-delta) starting consisting of SIRIUS 3RT and 3TF6 contactors, up to 710 kW

#### Overview

The individual parts for the contactor assemblies for star-delta (wye-delta) starting for customer assembly must be ordered separately.

- 3RT contactors (see page 3/64 onwards) and 3RT12 and 3TF6 vacuum contactors (see page 3/135 onwards):  
The operating times of the individual contactors are rated in such a way that no overlapping of the contact connection and the arcing time between two contactors can occur on reversing, provided they are interlocked by way of their auxiliary switches (NC contact interlock) and the mechanical interlock.  
For assemblies with AC operation and 50/60 Hz, a dead interval of 50 ms must be provided when used with voltages over 500 V; a dead interval of 30 ms is recommended for use with voltages up to and including 400 V. These dead times do not apply to assemblies with DC operation.  
The operating times of the individual contactors are not affected by the mechanical interlock.
- Mechanical interlocks
  - 3RT contactors and 3RT12 vacuum contactors: Adapter and mechanical interlock to interlock S6 and S3, see page 3/108.
  - 3TF68 vacuum contactors: Locking device for mechanical interlock, see page 3/135.
- Wiring kits consisting of wiring modules or link rails and star jumpers
  - 3RT contactors and 3RT12 vacuum contactors: see page 3/106 onwards
  - 3TF68 vacuum contactors: see page 3/135
- Base plates
  - 3RT contactors and 3RT12 vacuum contactors: see page 3/113
  - 3TF68 vacuum contactors: see page 3/135

#### Additional components

- For momentary-contact operation: auxiliary switch (NO contact) for self-locking
- 3RB2 overload relays (see page 7/114 onwards), SIMOCODE pro 3UF7 motor management and control devices (see page 10/12 onwards) or 3RN2 thermistor motor protection relays (see page 10/136 onwards) can be used for overload protection.  
The overload relay can either be mounted on the line contactor or separately fitted. It must be set to 0.58 times the rated motor current.
- Optional surge suppression for the S3 contactors; the contactors in sizes S6 to S12 are wired as standard with varistors.

The contactor assemblies for star-delta (wye-delta) starting for customer assembly are designed for standard applications.

#### Note:

Contactor assemblies for star-delta (wye-delta) starting in special applications such as very heavy starting<sup>1)</sup> or star-delta (wye-delta) starting of special motors must be customized. Help with designing such special applications is available from our Technical Support, [www.siemens.com/support-request](http://www.siemens.com/support-request).

<sup>1)</sup> For effective assistance from Technical Support, you must provide the following details:

- Rated motor voltage,
- Rated motor current,
- Service factor, operating values
- Motor starting current factor
- Starting time
- Ambient temperature



Video: SIRIUS contactor assembly for star-delta (wye-delta) starting – configuration example with 75 kW contactors

#### More information

Homepage, see [www.siemens.com/sirius](http://www.siemens.com/sirius)

Industry Mall, see [www.siemens.com/product?3RA24\\_3RT](http://www.siemens.com/product?3RA24_3RT)

Guide of use for contactors in safety applications, see <https://support.industry.siemens.com/cs/ww/en/view/109807687>

## Switching devices – Contactors and contactor assemblies – for switching motors

### Contactor assemblies for star-delta (wye-delta) starting

Contactor assemblies for star-delta (wye-delta) starting consisting of SIRIUS 3RT and 3TF6 contactors, up to 710 kW

**Contactor assemblies for star-delta (wye-delta) starting for customer assembly · Size S6-S6-S3 · Up to 160 kW**

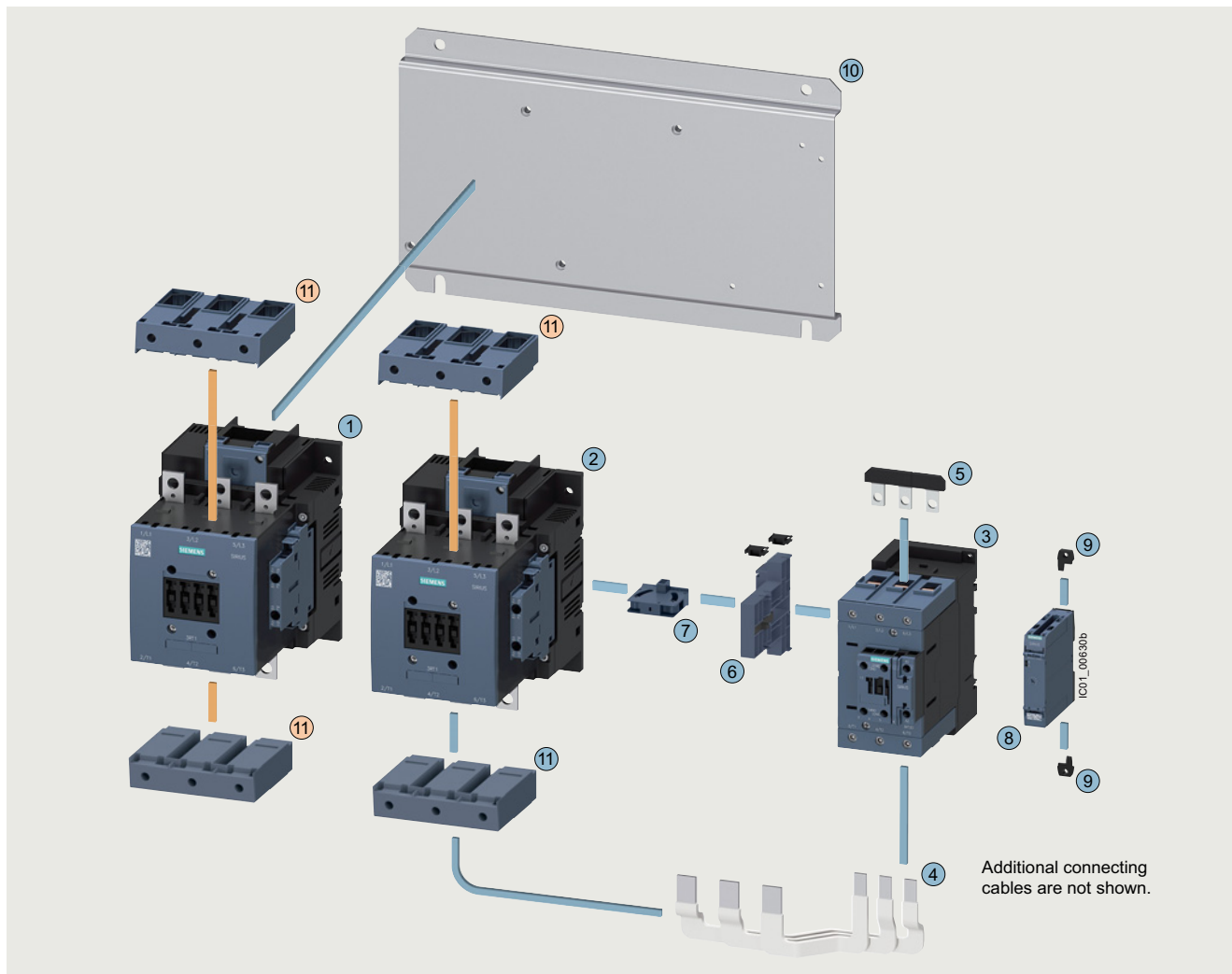

#### Mountable accessories (optional)

To be ordered separately	Type	Page
① Box terminal blocks	3RT1955-4G	3/110

#### Contactor assemblies for star-delta (wye-delta) starting for customer assembly

Individual parts	Type			Page
	Q11	Q13	Q12	
①②③ Contactors, 110 kW	3RT1054	3RT1054	3RT2045	3/51, 3/59, 3/63 ... 3/66
①②③ Contactors, 132 kW	3RT1055	3RT1055	3RT2046	3/51, 3/59, 3/63 ... 3/66
①②③ Contactors, 160 kW	3RT1056	3RT1056	3RT2047	3/51, 3/59, 3/63 ... 3/66
④ <u>Assembly kit S6-S6-S3 for contactors with box terminals</u> consisting of: Wiring modules, bottom	3RA1953-3G			3/106
⑤ Star jumper S3	3RT1946-4BA31			3/107
⑥ Adapter for the mechanical interlock between S6 and S3 (including two connectors)	3RA1954-2G <sup>1)</sup>			3/108
⑦ Mechanical interlock between S6 and S3	3RA1954-2A			3/108
⑧ Timing relay with star-delta (wye-delta) function	3RP257.			10/34
⑨ Push-in lugs for star-delta (wye-delta) timing relays	3ZY1311-0AA00			10/35
⑩ Base plate star-delta (wye-delta)	3RA1952-2E			3/113
⑪ Box terminal block	3RT1955-4G			3/110

<sup>1)</sup> The 3RA1954-2G adapter cannot be used in conjunction with 3RT204...-KB coupling contactors, size S3.

## Switching devices – Contactors and contactor assemblies – for switching motors

### Contactor assemblies for star-delta (wye-delta) starting

Contactor assemblies for star-delta (wye-delta) starting consisting of SIRIUS 3RT and 3TF6 contactors, up to 710 kW

Contactor assemblies for star-delta (wye-delta) starting for customer assembly · Size S6-S6-S6 · Up to 160 kW

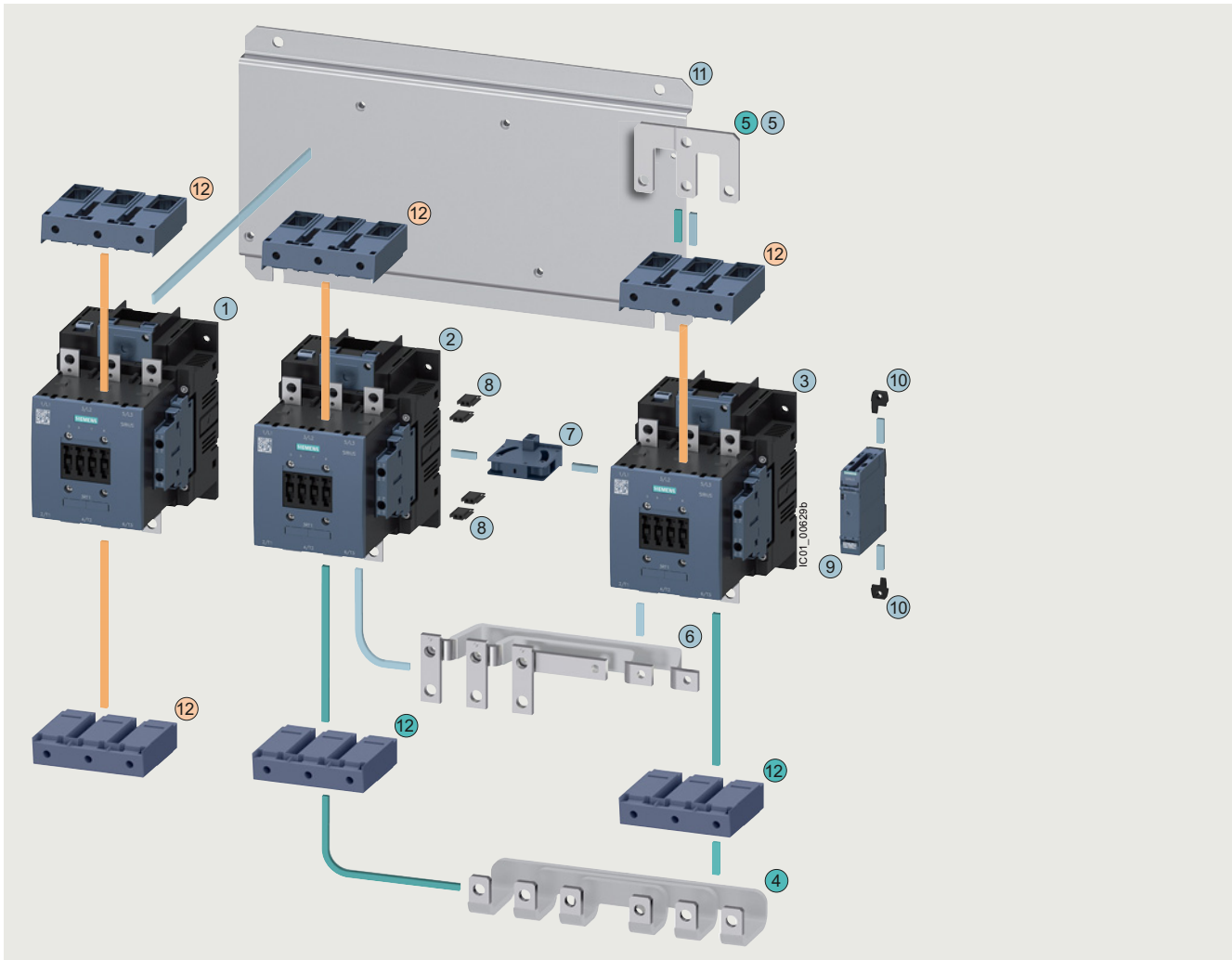

#### Mountable accessories (optional)

To be ordered separately	Type	Page
12	Box terminal blocks	3/110

#### Contactor assemblies for star-delta (wye-delta) starting for customer assembly

Individual parts	Type			Page
	Q11	Q13	Q12	
1 2 3	3RT1054	3RT1054	3RT1054	3/64 ... 3/66
1 2 3	3RT1055	3RT1055	3RT1055	3/64 ... 3/66
1 2 3	3RT1056	3RT1056	3RT1056	3/64 ... 3/66
4 5	3RA1953-2B			3/106
Assembly kit S6-S6-S6 for contactors with box terminals consisting of:				
4				
5				
5 6	3RA1953-2N			3/106
Assembly kit S6-S6-S6 for contactors without box terminals consisting of:				
6				
5				
7	3RA1954-2A			3/108
8	3RA1932-2D			3/108
9	3RP257			10/34
10	3ZY1311-0AA00			10/35
11	3RA1952-2F			3/113
12	3RT1955-4G			3/110



Video: SIRIUS contactor assembly for star-delta (wye-delta) starting – configuration example with 75 kW contactors



## Switching devices – Contactors and contactor assemblies – for switching motors

### Contactor assemblies for star-delta (wye-delta) starting

Contactor assemblies for star-delta (wye-delta) starting consisting of SIRIUS 3RT and 3TF6 contactors, up to 710 kW

Contactor assemblies for star-delta (wye-delta) starting for customer assembly · Size S10-S10-S6 · Up to 250 kW

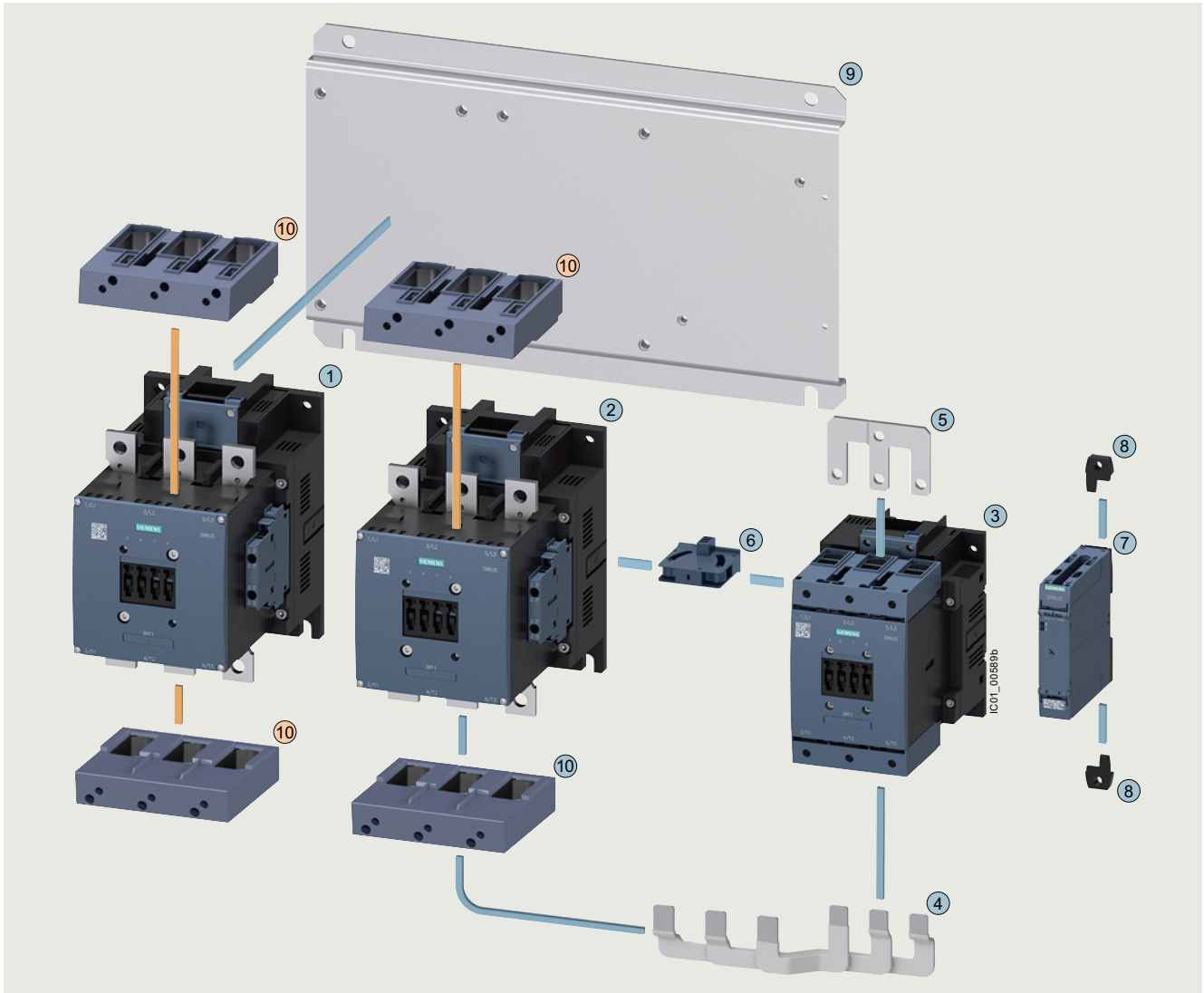

#### Mountable accessories (optional)

To be ordered separately	Type	Page
⑩ Box terminal blocks	3RT1966-4G	3/110

#### Contactor assemblies for star-delta (wye-delta) starting for customer assembly

Individual parts	Type			Page
	Q11	Q13	Q12	
①②③ Contactors, 200 kW	3RT1.64	3RT1.64	3RT1054	3/64 ... 3/66, 3/130
①②③ Contactors, 250 kW	3RT1.65	3RT1.65	3RT1055	3/64 ... 3/66, 3/130
④ Assembly kit S10-S10-S6 for contactors with box terminals consisting of: Wiring modules, bottom	3RA1963-3E			3/106
⑤ Star jumper S6	3RT1956-4BA31			3/107
⑥ Mechanical interlock between S10 and S6	3RA1954-2A			3/108
⑦ Timing relay with star-delta (wye-delta) function	3RP257.			10/34
⑧ Push-in lugs for star-delta (wye-delta) timing relays	3ZY1311-0AA00			10/35
⑨ Base plate star-delta (wye-delta)	3RA1962-2E			3/113
⑩ Box terminal block	3RT1966-4G			3/110



Video: SIRIUS contactor assembly for star-delta (wye-delta) starting – configuration example with 75 kW contactors

## Switching devices – Contactors and contactor assemblies – for switching motors

### Contactor assemblies for star-delta (wye-delta) starting

Contactor assemblies for star-delta (wye-delta) starting consisting of SIRIUS 3RT and 3TF6 contactors, up to 710 kW

Contactor assemblies for star-delta (wye-delta) starting for customer assembly · Size S10-S10-S10 · Up to 250 kW

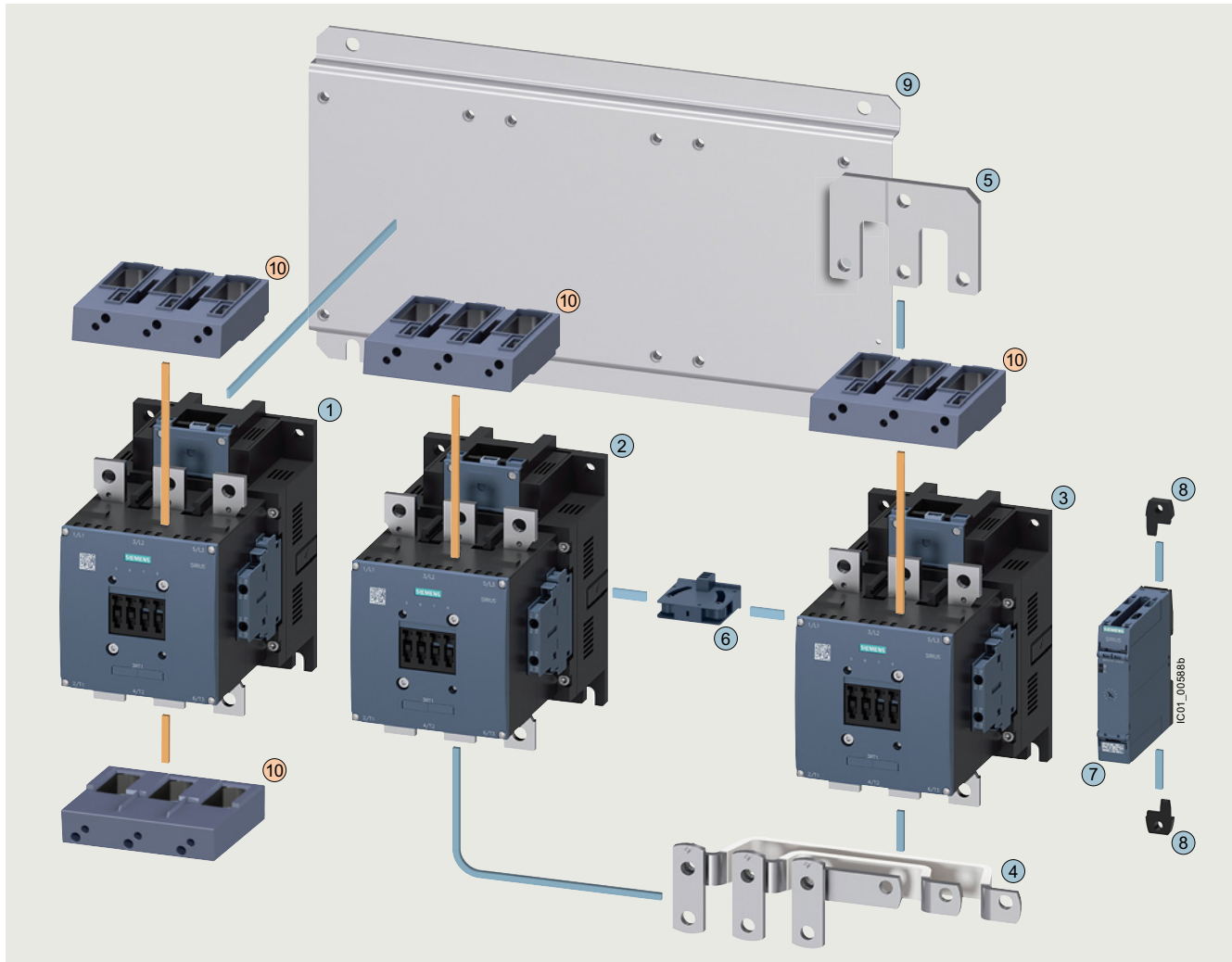

#### Mountable accessories (optional)

To be ordered separately	Type	Page
⑩ Box terminal blocks	3RT1966-4G	3/110

#### Contactor assemblies for star-delta (wye-delta) starting for customer assembly

Individual parts	Type			Page
	Q11	Q13	Q12	
①②③ Contactors, 200 kW	3RT1.64	3RT1.64	3RT1.64	3/64 ... 3/66, 3/130
①②③ Contactors, 250 kW	3RT1.65	3RT1.65	3RT1.65	3/64 ... 3/66, 3/130
④⑤ Assembly kit S10-S10-S10 for contactors without box terminals consisting of:	3RA1963-2B			3/106
④ Link rails, bottom				
⑤ Star jumper S10				
⑥ Mechanical interlock	3RA1954-2A			3/108
⑦ Timing relay with star-delta (wye-delta) function	3RP257.			10/34
⑧ Push-in lugs for star-delta (wye-delta) timing relays	3ZY1311-0AA00			10/35
⑨ Base plate star-delta (wye-delta)	3RA1962-2F			3/113



Video: SIRIUS contactor assembly for star-delta (wye-delta) starting – configuration example with 75 kW contactors

## Switching devices – Contactors and contactor assemblies – for switching motors

### Contactor assemblies for star-delta (wye-delta) starting

Contactor assemblies for star-delta (wye-delta) starting consisting of SIRIUS 3RT and 3TF6 contactors, up to 710 kW

Contactor assemblies for star-delta (wye-delta) starting for customer assembly · Size S12-S12-S10 · Up to 500 kW

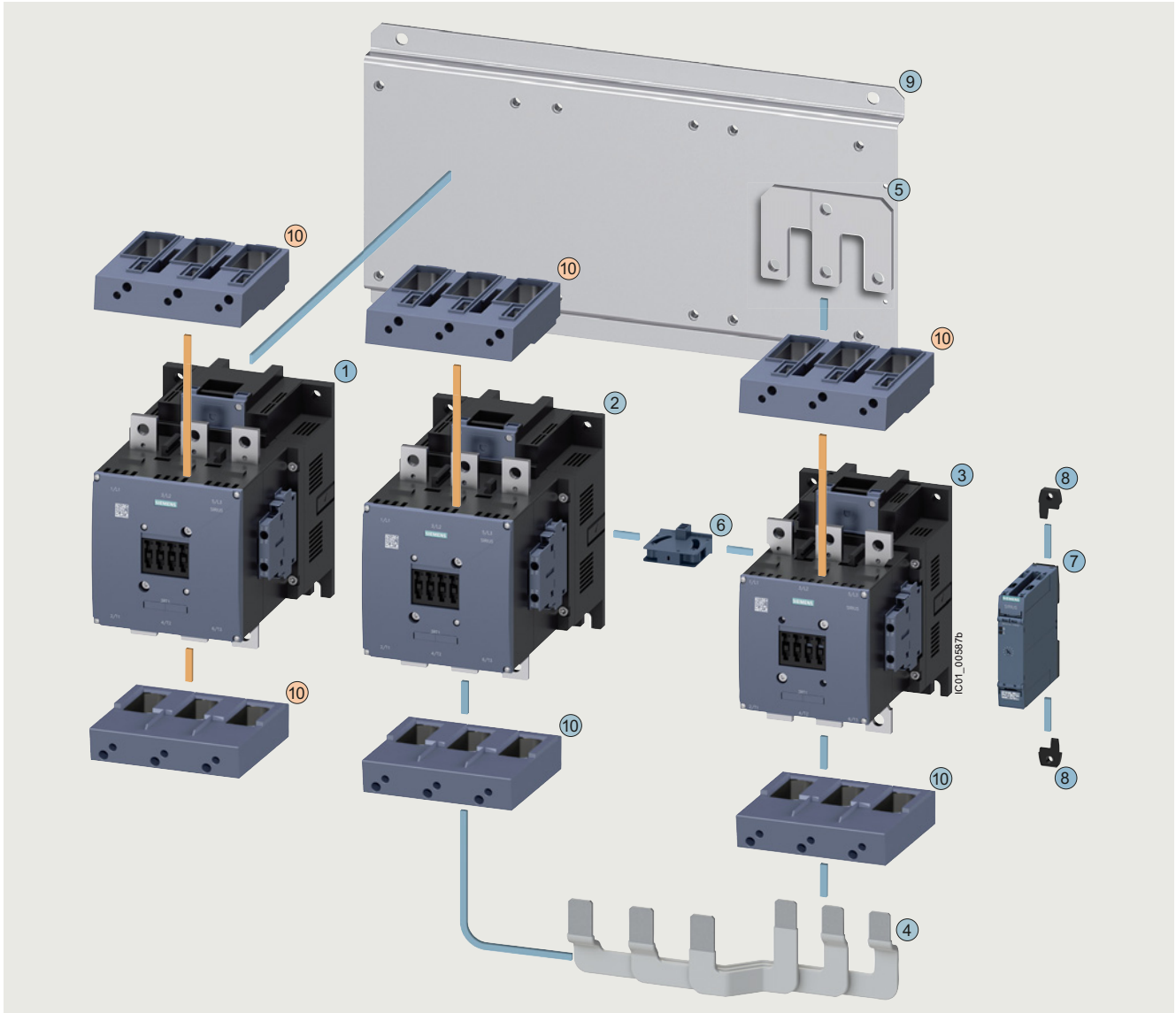

#### Mountable accessories (optional)

To be ordered separately Type Page

⑩ Box terminal blocks 3RT1966-4G 3/110

#### Contactor assemblies for star-delta (wye-delta) starting for customer assembly

Individual parts

①②③ Contactors, 355 kW  
 ①②③ Contactors, 400 kW  
 ①②③ Contactors, 500 kW  
 ④ Assembly kit S12-S12-S10  
 for contactors with box terminals  
 consisting of:  
 Wiring modules, bottom

⑤ Star jumper S10 3RT1966-4BA31 3/107  
 ⑥ Mechanical interlock between S12 and S10 3RA1954-2A 3/108  
 ⑦ Timing relay with star-delta (wye-delta) function 3RP257. 10/34  
 ⑧ Push-in lugs for star-delta  
(wye-delta) timing relays 3ZY1311-0AA00 10/35  
 ⑨ Base plate star-delta (wye-delta) 3RA1972-2E 3/113  
 ⑩ Box terminal blocks 3RT1966-4G 3/110

Type

Q11

Q13

Q12

Page

3RT1.75 3RT1.75 3RT1.64 3/64 ... 3/66, 3/130

3RT1.75 3RT1.75 3RT1.65 3/64 ... 3/66, 3/130

3RT1.76 3RT1.76 3RT1.66 3/64 ... 3/66, 3/130

3RA1973-3E 3/106



Video: SIRIUS contactor assembly for star-delta (wye-delta) starting – configuration example with 75 kW contactors



## Switching devices – Contactors and contactor assemblies – for switching motors

### Contactor assemblies for star-delta (wye-delta) starting

Contactor assemblies for star-delta (wye-delta) starting consisting of SIRIUS 3RT and 3TF6 contactors, up to 710 kW

Contactor assemblies for star-delta (wye-delta) starting for customer assembly · Size S12-S12-S12 · Up to 500 kW

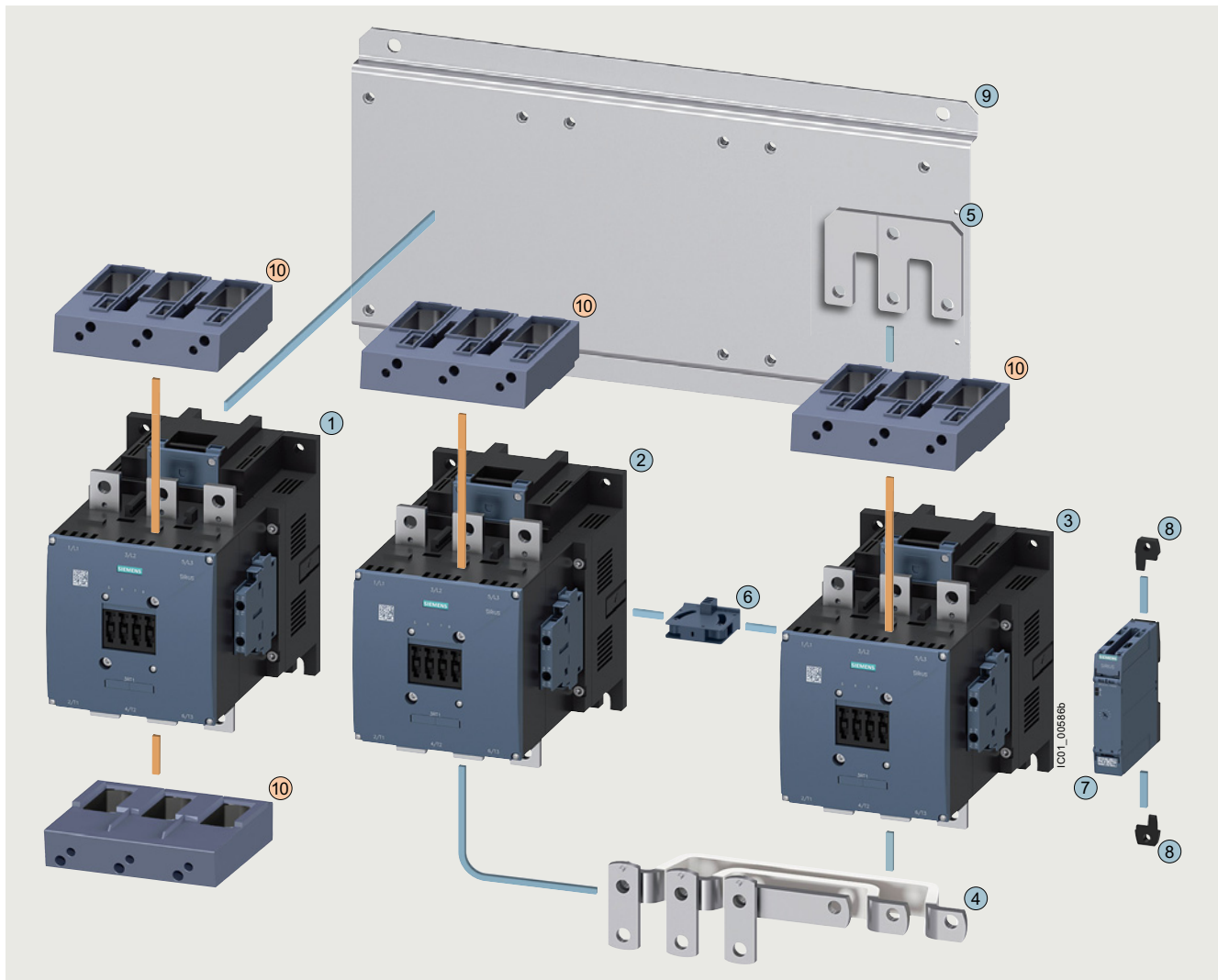

#### Mountable accessories (optional)

To be ordered separately	Type	Page
⑩	Box terminal blocks	3/110

#### Contactor assemblies for star-delta (wye-delta) starting for customer assembly

Individual parts	Type			Page
	Q11	Q13	Q12	
①②③	3RT1.75	3RT1.75	3RT1.75	3/64 ... 3/66, 3/130
①②③	3RT1.76	3RT1.76	3RT1.76	3/64 ... 3/66, 3/130
④⑤	3RA1973-2B			3/106
Assembly kit S12-S12-S12 for contactors without box terminals consisting of:				
④	Link rails, bottom			
⑤	Star jumper S12			
⑥	Mechanical interlock	3RA1954-2A		3/108
⑦	Timing relay with star-delta (wye-delta) function	3RP257.		10/34
⑧	Push-in lugs for star-delta (wye-delta) timing relays	3ZY1311-0AA00		10/35
⑨	Base plate star-delta (wye-delta)	3RA1972-2F		3/113



Video: SIRIUS contactor assembly for star-delta (wye-delta) starting – configuration example with 75 kW contactors

## Switching devices – Contactors and contactor assemblies – for switching motors

### Contactor assemblies for star-delta (wye-delta) starting

Contactor assemblies for star-delta (wye-delta) starting consisting of SIRIUS 3RT and 3TF6 contactors, up to 710 kW

Contactor assemblies for star-delta (wye-delta) starting for customer assembly · Sizes 14-14-S12 · Up to 710 kW

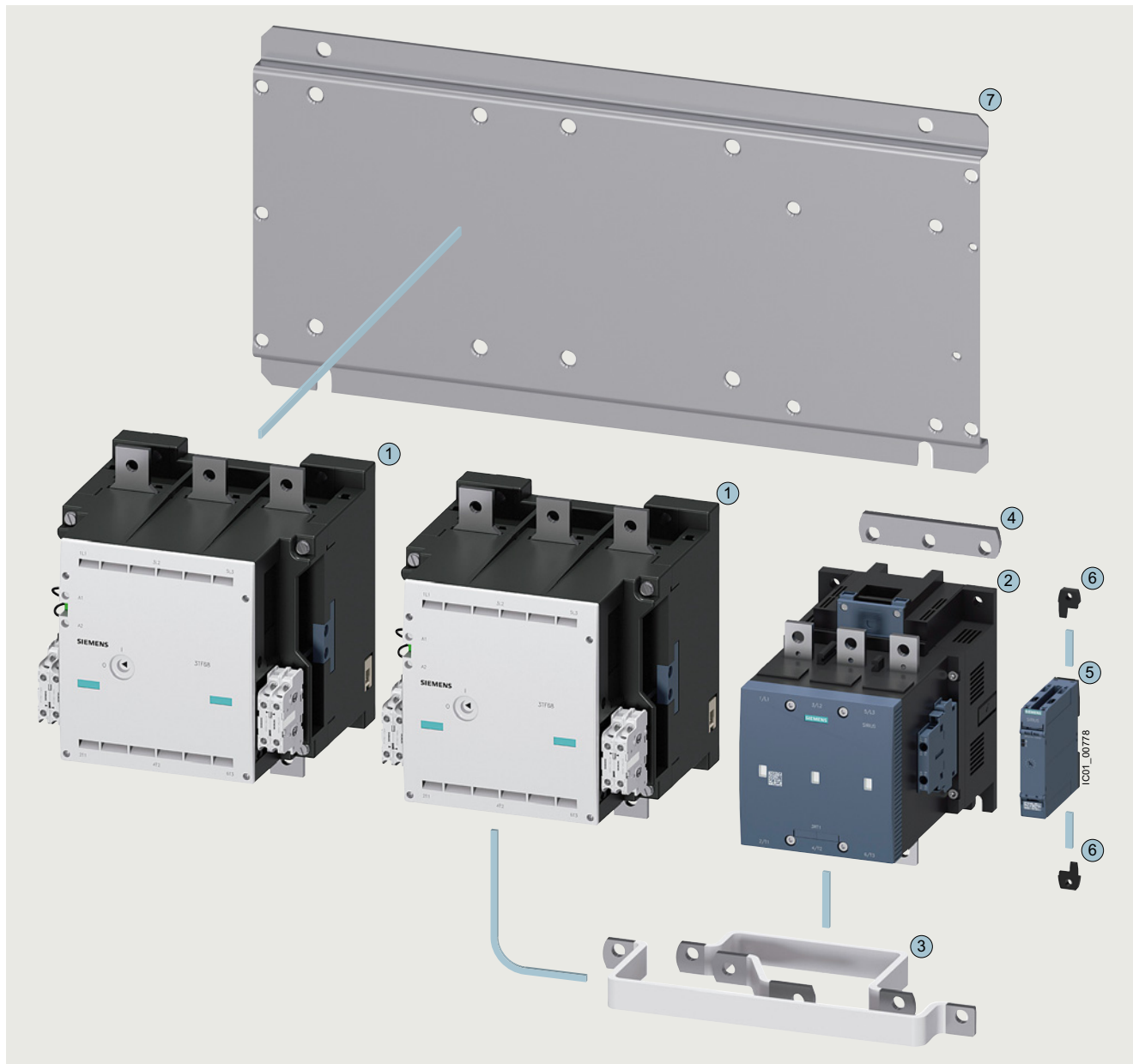

#### Contactor assemblies for star-delta (wye-delta) starting for customer assembly

##### Individual parts

	Type	Q11	Q13	Q12	Page
① ②	Contactors, 710 kW	3TF68	3TF68	3RT127.	3/130 ... 3/132
③ ④	Assembly kit 14-14-S12 for contactors without box terminals consisting of:	3TX7680-1B			3/135
③	Wiring modules on the top and bottom				
④	Star jumper S12				
⑤	Timing relay with star-delta (wye-delta) function	3RP257.			10/34
⑥	Push-in lugs for star-delta (wye-delta) timing relays	3ZY1311-0AA00			10/35
⑦	Base plate star-delta (wye-delta)	3TX7681-1B			3/135