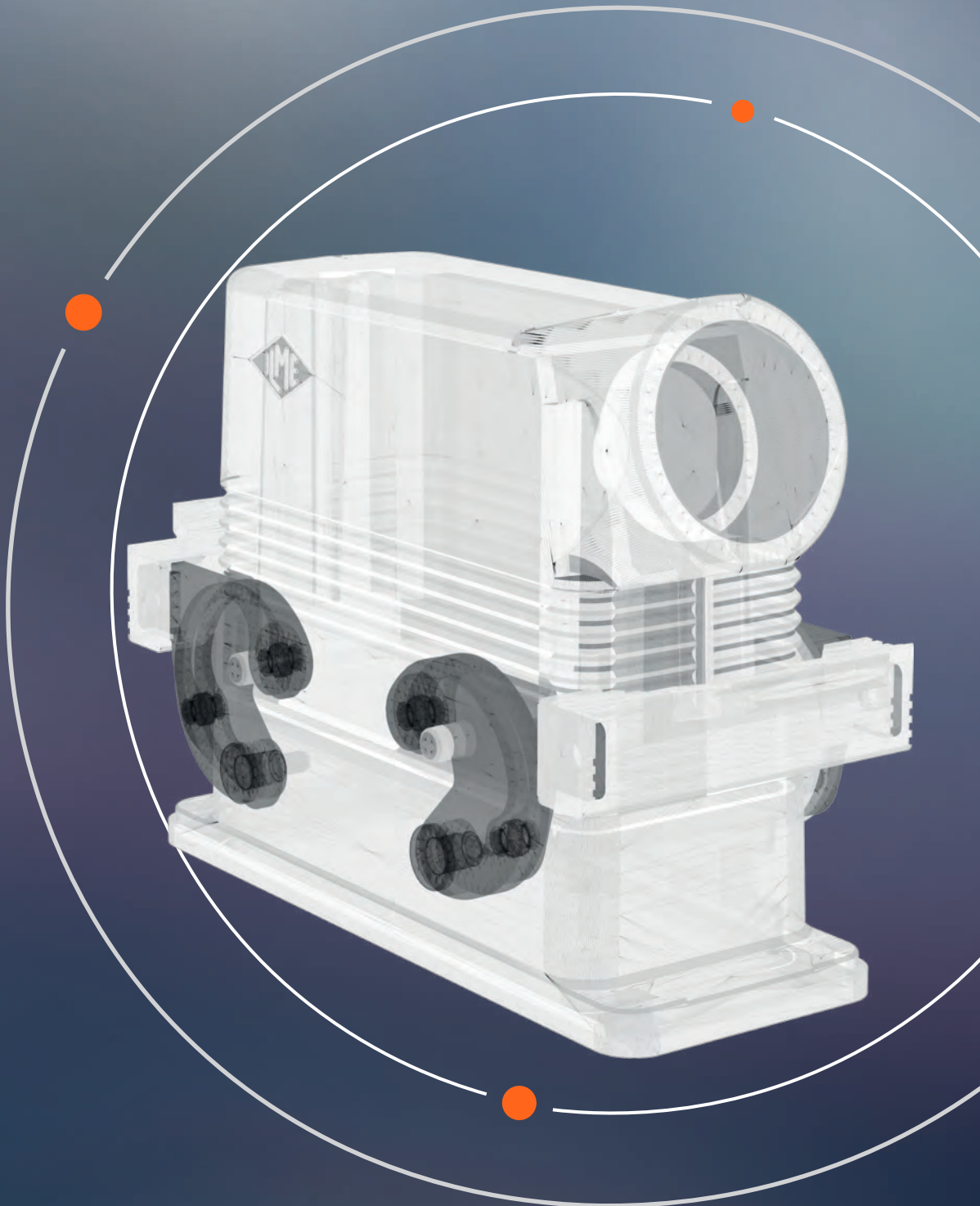




Multipole connectors for industrial purposes

GENERAL CATALOGUE





Multipole connectors for industrial purposes

G E N E R A L

C A T A L O G U E

CN. 19



THE TRADITION OF INNOVATION SINCE 1945

ILME designs and manufactures complete solutions for industrial connections.

Headquartered in Milan and with subsidiaries in the key countries driving the progress of automation, ILME is an industry leader in the main world markets.

People are vital to success and growth at ILME, sharing a passion for innovation, utmost responsibility and participation.

The Company is committed to developing technology in the areas that most impact the future of the industries it serves: high quality and safe cabling, research on the most suitable materials, rapid turnaround and readily available services while striving for energy saving and environmental safeguard.

COMMITMENT TO INDUSTRY

Technological innovation is the main pillar of ILME competitiveness.

In the electrical connection sector of industrial automation, characterized by the need for top performance and reliability, ILME is an acknowledged leader with its own patents and a global benchmark supplier of major companies worldwide.

ILME offers a fully integrated range of high-quality products and services for every type of connection to suit any application requirements.



AUTOMATION



RAILWAY



ENERGY



NAVAL



FOOD
& BEVERAGE



AGRONOMY



OUTDOOR



TRANSPORT



LIGHT
& SOUND



PLASTIC



CHEMICAL



AIRPORT

Practical advices for consulting the catalogue

Page layout and index

The ILME General Catalogue is divided into **six** sections to make it easier its consultation. All the products included have been grouped together by product lines.

The **sections** are marked with different colours to facilitate their immediate identification.

Please refer to the example page at right.

1 Six sections marked by different colours:

 **INTRODUCTION**

 **INSERTS**

 **MIXO INSERTS**

 **ENCLOSURES**

 **ACCESSORIES AND TOOLS**

 **APPENDIX**

2 Sub-sections showing the specific product page

3 Chapters and technical detail page

4 Combinations and pictures

List of the possible combinations between inserts and enclosures

5 Product descriptions and part numbers

6 Technical descriptions, 2D drawings

7 Load curves (for more information please refer to page 28)

The **figurative index**, that opens each section, clearly shows the series of products relevant to each product line.

Icons

Published in the “Combinations and pictures” area to to highlight specific points.



Important technical information



Key feature



Certifications and ratings



Availability of the products

Notes

- Dimensions shown are not binding and may be changed without notice.
- All pictures shown are for illustration purpose only. Actual products may vary due to product enhancement.
- Enclosures pictures are not exhaustive and show just a few representative examples. For more details of a specific part No., please consult the online product data sheet.

Example page

INTRODUCTION

INSERTS

MIXO INSERTS

ENCLOSURES

ACCESSORIES AND TOOLS

APPENDIX

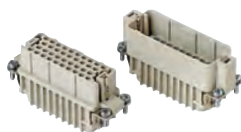
Inserts

CDD 38 poles + ⊕ 10A - 250V

enclosures: size "66.16"	page:
IL-BRID	378 - 382
CZ7 IP67, single lever	385
W-TYPE for aggressive environments	520
E-Xtreme® corrosion proof	541
EMC	577

panel supports: COB	page:
	652 - 653

inserts, crimp connections

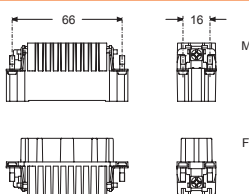


10A crimp contacts silver and gold plated

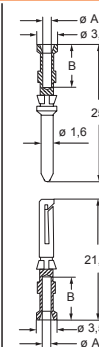
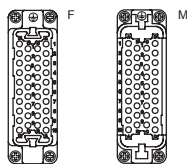


description	part No.	part No.	part No.
without contacts (to be ordered separately)			
female inserts for female contacts	CDDF 38		
male inserts for male contacts	CDDM 38		
10A female contacts			
0,14-0,37 mm ² AWG 26-22 identification No. 1		CDFA 0.3	CDFD 0.3
0,5 mm ² AWG 20 identification No. 2		CDFA 0.5	CDFD 0.5
0,75 mm ² AWG 18 identification No. ②		CDFA 0.7	CDFD 0.7
1 mm ² AWG 18 identification No. 3		CDFA 1.0	CDFD 1.0
1,5 mm ² AWG 16 identification No. 4		CDFA 1.5	CDFD 1.5
2,5 mm ² AWG 14 identification No. 5		CDFA 2.5	CDFD 2.5
10A male contacts			
0,14-0,37 mm ² AWG 26-22 identification No. 1		CDMA 0.3	CDMD 0.3
0,5 mm ² AWG 20 identification No. 2		CDMA 0.5	CDMD 0.5
0,75 mm ² AWG 18 identification No. ②		CDMA 0.7	CDMD 0.7
1 mm ² AWG 18 identification No. 3		CDMA 1.0	CDMD 1.0
1,5 mm ² AWG 16 identification No. 4		CDMA 1.5	CDMD 1.5
2,5 mm ² AWG 14 identification No. 5		CDMA 2.5	CDMD 2.5

- characteristics according to EN 61984:
- 10A 250V 4kV 2**
- certified
- rated voltage according to UL/CSA: 600V
- insulation resistance: ≥ 10 GΩ
- ambient temperature limit: -40 °C ... +125 °C
- made of self-extinguishing thermoplastic resin UL 94V-0
- mechanical life: ≥ 500 cycles
- contact resistance: ≤ 3 mΩ
- for applications requiring higher voltages, please see the special voltage application section on page 75
- **it is recommended to crimp the contacts with crimping tools homologated by ILME** (please see the crimping tool section 10A contacts, CDF and CDM series on pages 705 - 741)
- for max. current load see the connector inserts derating diagram below; for more information see page 28

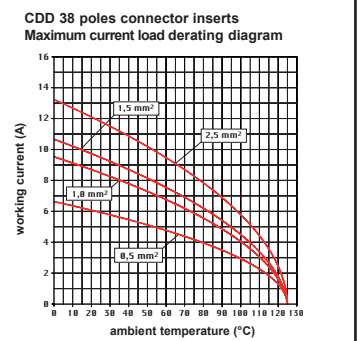


contacts side (front view)



CDF and CDM contacts

conductor section mm ²	conductor slot ø A (mm)	conductors stripping length B (mm)
0,14-0,37	0,9	8
0,5	1,1	8
0,75	1,3	8
1,0	1,45	8
1,5	1,8	8
2,5	2,2	6



CR CP coding pin with loss of one contact (page 689)



⊕ for basic or high thickness gold plating, please refer to page 674

INTRODUCTION

IMPORTANT NOTES.....	8	• LOAD CURVES	28
CE MARKING	9	• TYPE OF ENCLOSURES	30
GENERAL FEATURES OF MULTIPOLE CONNECTORS ...	10	• APPLICATIONS SECTORS.....	33
• STANDARD INSERTS	12	• LOCKING SYSTEMS.....	34
• MIXO MODULAR UNITS	13	• TYPE OF COVERS	35
• INSERTS FEATURES.....	14	• TYPE OF HOODS / HOUSINGS.....	36
• MIXO INSERTS FEATURES	18	• ENCLOSURES FEATURES	42
• RECOMMENDED TIGHTENING TORQUE.....	20	• THE DEGREE OF PROTECTION.....	46
• RANGE OF CONDUCTOR CROSS-SECTIONAL AREA AND STRIPPING LENGHT	21	• CHANGEOVER FROM PG THREADS TO METRIC.....	47
• CONDUCTOR CONNECTION TECHNOLOGY	22	• COMBINATIONS BETWEEN ENCLOSURES AND INSERTS	48
• CRIMP CONTACTS OVERVIEW	27	• ACCESSORIES AND TOOLS FOR INSERTS AND ENCLOSURES	50

From page

INSERTS

52

• SCREW / SPRING / CRIMP CONNECTIONS UP TO 10A	58
• SQUICH® CONNECTION WITHOUT TOOLS 6A, 10A, 16A	63
• SCREW / SPRING / CRIMP CONNECTIONS UP TO 16A.....	98
• SCREW CONNECTIONS, CP - CP...RY SERIES UP TO 35A	178
• CRIMP CONNECTIONS, CQ SERIES 6,5A, 10A, 16A, 40A	182
• SCREW / CRIMP CONNECTIONS, CX SERIES 10A, 16A, 40A, 80A, 100A	194
• CRIMP CONNECTIONS, HNM SERIES 10A, 16A, 40A.....	208
• DATA CONNECTORS	222
• DESINA®.....	244

MIXO INSERTS

252

• MIXO 4A, 5A, 10A, 16A, 40A, 70A, 100A, 200A	262
• MIXO DATA	286
• CRIMP CONNECTIONS, MIXO HNM SERIES 10A, 16A, 40A	320

ENCLOSURES

334

• STANDARD APPLICATIONS: CK-CKA-MKA, CQ, IL-BRID, CZ7 RIGID LEVER, C-TYPE, T-TYPE, COB.....	339
• SPECIAL ENCLOSURES: MIXO ONE, BIG, EMC, 180 °C, HNM, CENTRAL LEVER	369
• WATERTIGHT:	
- IP67 (V-TYPE).....	436
- IP65/IP66 (V-TYPE)	444
- IP68 (CGK/MGK, CG/MG).....	628
• AGGRESSIVE ENVIRONMENTS: T-TYPE/W, W-TYPE, E-Xtreme®	489
• FOR SPECIFIC APPLICATIONS:	
- HYGIENIC	501
- LS-TYPE	618

ACCESSORIES AND TOOLS

662

• ACCESSORIES	666
• CRIMPING TOOLS	704

APPENDIX

742

• DIMENSIONING OF CLEARANCES AND CREEPAGE DISTANCES	744
• EU ENVIRONMENTAL LEGISLATION.....	750
• FIRE PROTECTION STANDARDS FOR RAILWAY APPLICATIONS	751
• STANDARDS AND CERTIFICATIONS	753
• SPECIFICATIONS	753
• ILME SMART CONFIGURATOR	754
• INDEX OF PART NUMBERS	756

IMPORTANT NOTES

Strictly tied to our general conditions of sales

- 1 ILME designs and manufactures complete solutions for Heavy Duty electrical power connections.
The connector (although offered to the user as a variety of elements, usually inserts and enclosures, to allow the selection of the ideal combination) has been **designed as a complete connector** and tested to be compliant with the essential safety requirements of the EU Low Voltage Directive 2014/35/EU from April 20, 2016 and in particular the EN 61984 standard. The design of this “whole” system guarantees that every allowed combination of inserts, enclosures and accessories cannot result as improper.

- 2 The products in this catalogue alone cannot guarantee the best functionality upon installation, as this depends also on their correct **“putting into service”** which must be performed in compliance with the applicable system safety standards and according to the “rule of the art”. Therefore the effectiveness of the installation of the connector depends on the choices of the end user who must also take into account the following safety requirements.

- 3 Connectors must **not be connected or disconnected when live or under load**.

- 4 After wiring the inserts it is necessary to **verify the continuity of the protective earth connections**.

- 5 The **correct coupling of the inserts** is guaranteed only if they are installed (with the four fixing screws supplied *) inside the corresponding enclosures or onto compatible accessories in this catalogue. ILME S.p.A. is not responsible for any different application.

- 6 Wiring of **screw-type terminal connections** must be carried out applying the correct tightening torque in order to avoid false contacts or damage to the conductor, the screw or the terminal.

- 7 **Crimping tools** and **crimp contacts** used should preferably be supplied by the same manufacturer to avoid difficulties with the insertion and retention or damaging of the contacts themselves.

- 8 Correct wiring of **spring-clamp connection inserts** is guaranteed only when the correct screwdriver indicated in the specific catalogue, or possibly on the insert, is used **.

- 9 Avoid forcing the contacts during **connection and disconnection**. Connectors must be coupled and uncoupled in the axial direction with respect to the contacts, without bending and pulling the attached conductor bundles or cables.

- 10 Installation of two **inserts side by side**, in enclosures with two bays, must respect the polarity drawing marked on the insert (or the contact side view, as shown in this catalogue) to avoid inverted coupling.

- 11 Installation of two or more identical **connectors side by side** is recommended only with the use of **coding pins** in order to avoid mismatched couplings.

- 12 In order to keep the declared **degree of protection** (IP code according to EN 60529, or Enclosure Type Rating according to ANSI/UL 50E), enclosures must be completed with cable glands and/or other accessories with at least an equal degree of protection.

- 13 Moreover, the declared **degree of protection** (IP code according to EN 60529, or Enclosure Type Rating according to ANSI/UL 50E) is guaranteed when the enclosures, complete with inserts, are coupled and locked with their locking levers (or devices).

- 14 Connector inserts and their enclosures are generally compatible with similar/equivalent products from other manufacturers, according to the last samples tested. Full compatibility cannot be guaranteed in the event of technical changes made by other manufacturers. In particular, maximum performance of IP68 enclosures (CG/MG and CGK/MGK Series) cannot be guaranteed when coupled with other manufacturers' products.

- 15 **Spare parts** are supplied in minimum quantities only with the purpose to replace damaged parts. To avoid invalidation of warranty, products should be modified or repaired only by ILME: the integrity of their functionality - e.g. their degree of protection - can no longer be guaranteed if products are modified/repared by end-users. In any case, the liability for correct choice, assembly and use is totally at charge of the installer and the end-user.

- 16 ILME S.p.A. takes no responsibility in verifying whether the components herein contained comply with any specific regulations of fields of application.

- 17 ILME cannot be held responsible for individual components in **uses other than those described in this catalogue**.
ILME cannot be held responsible for **incorrect connector selection** in relation to the environmental conditions of the application (e.g.: influence of ambient temperature, moisture, environmental pollution, etc.).

* Except one fixing screw for size “21.21” inserts, two fixing screws for size “32.13” inserts.

** Except for **SQUICH®** inserts (with spring-clamp terminals with actuator button) that do not require any tool to operate the terminal.

CE MARKING

As from 1st January 1997, in order to make available electrical products on the European market, the manufacturer must ensure that these bear the relevant **CE marking**, in line with the Low Voltage Directive 73/23/EEC* (implemented in Italy as L. D. 18-10-1977 no. 791) and its modification 93/68/EEC* (implemented in Italy as L.D. 25-11-1996 no. 626/96, published in the supplement to the Gazzetta Ufficiale of 14-12-1996).

The CE marking must be visible on the product or, if this is not possible, on the packaging, the instructions for use or on the warranty certificate. It acts as a declaration by the manufacturer that the product complies with all relevant EU directives regarding its field of application.

ILME products bear the CE marking on the actual product or its packaging.

Almost all ILME products fall within the scope of the Low Voltage Directive. An EU declaration of conformity is required in order to be able to apply the CE marking. This declaration, to which the market is not directly entitled, must be made available to the controlling authorities (in Italy, the Ministry of Economic Development) at all times. In it, the manufacturer declares the technical safety standard(s) followed in the design and manufacture of the product. These standards must be, in decreasing order of preference:

- a European standard (EN prefix)
- a European harmonisation document (HD prefix)
- an international IEC standard
- a national standard
- in the absence of reference standards, the manufacturer's internal specifications guaranteeing compliance with the basic safety requirements of the directive.

Conformity with harmonised technical standards (i.e. ratified by CENELEC) also constitutes presumption of conformity with the basic safety requirements of the directives.

The CE marking of ILME products results from the declaration of conformity of the product to harmonised standards or international IEC standards.

Through the CE marking, ILME declares full compliance, not merely with the directive's basic safety requirements, but also with those international or national standards on which voluntary safety certification markings are based (e.g. IMQ and VDE). In this way, ILME intends to give the CE marking the value of self-certification in terms of safety, given the loss in legal value of voluntary certifications issued by third parties, ratified by directive 93/68/EEC*.

Notwithstanding the above, practically all ILME products still bear voluntary conformity markings.

The above mentioned EU declaration of conformity becomes null and void when the assembly of products includes one or more components not manufactured by ILME and without CE marking.

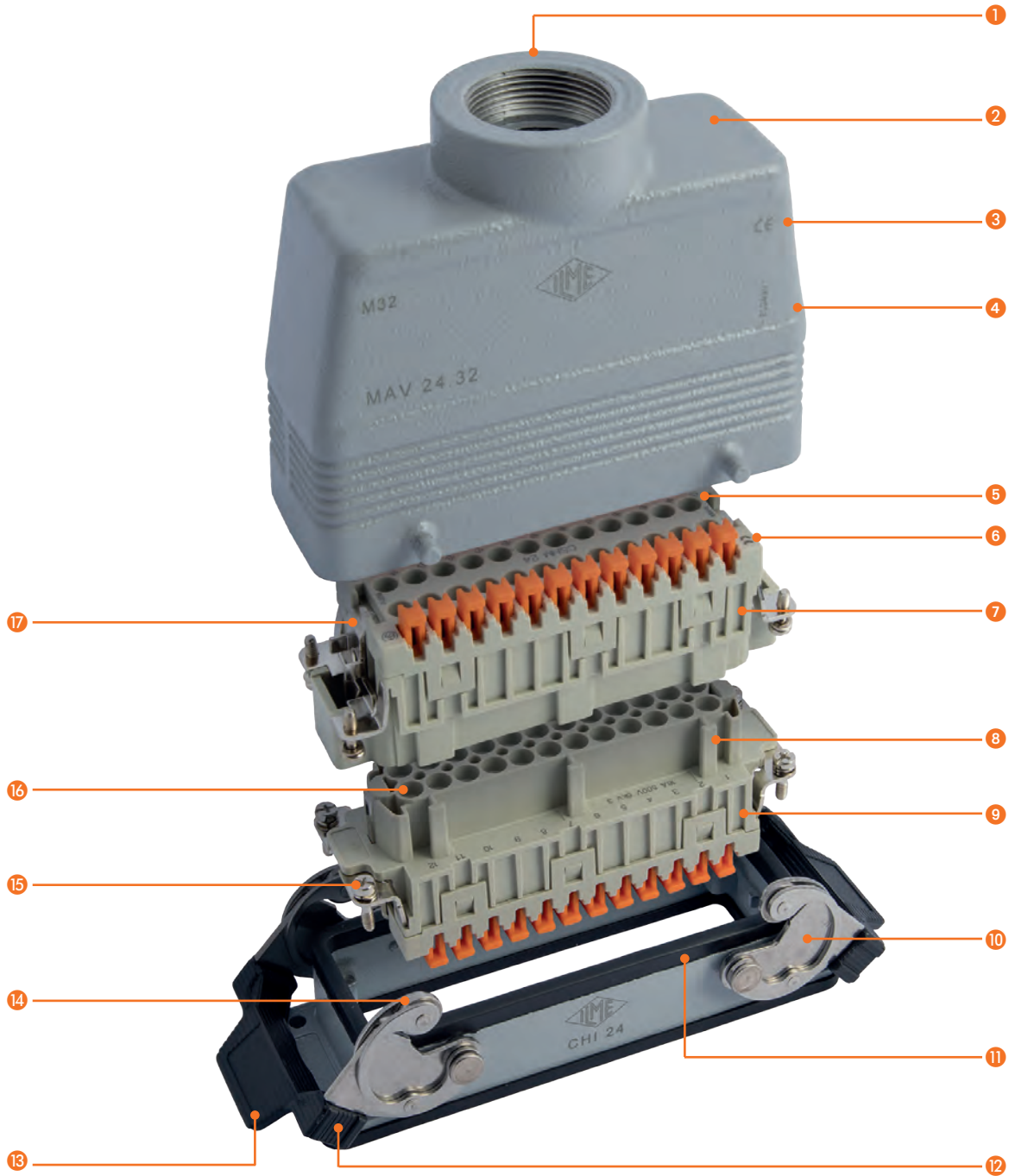
▲ The information contained in this catalogue is not binding and may be changed without notice.

* **Note:** The subsequent legal reference for the Low Voltage Directive was 2006/95/EC, as consolidation of the original Directive 73/23/EEC + Directive 93/68/EEC. On 29th March 2014, the Official Journal of the European Union published the new Low Voltage directive 2014/35/EU dd. 26th February 2014, a recast version of directive 2006/95/EC, which is in force since 20th April 2016.



UNI EN ISO 9001: 2015
Design, manufacture and distribution
of industrial electrical equipment (IAF 19)
Certificate No. 50 100 11133

GENERAL FEATURES OF MULTIPOLE CONNECTORS



- 1 **Threaded cable entry** in various Pg diameters (types with pre-code "C") or metric cable entry (types with pre-code "M") in accordance with EN 60423, for cable entry devices in accordance with EN 62444 (NPT threading on request), may be located vertically, horizontally or frontally.
- 2 Rugged die-cast **aluminium alloy** or **zinc alloy** (most of CKA, MKA) or **self-extinguishing thermoplastic** enclosures (types CK, MK, CQ 08, MQ 08 and T-TYPE), cULus approved.
Surface-mounting, bulkhead, and hood versions available, with or without hinged cover, or with free protection covers. Enclosure types CH-CA (w/ Pg cable entries) and MH-MA (w/ metric cable entries) have an internal tab that prevents the insertion of higher voltage inserts series CME (all) and CMCE (only 16+2 poles), while CM (Pg) enclosures series and MM (metric) dedicated to those 830 V inserts have no tab and contain supplementary insulating strips inside.
- 3 **CE marking** attesting conformity to the requirements of the Low Voltage directive (2014/35/EU).
- 4 Metallic enclosures with a coated **finish** of thermosetting epoxy-polyester (epoxy for W-TYPE, IP68 CG/MG and E-Xtreme®) with high resistance to mechanical stress and external agents. Enclosures for use at temperatures up to 180 °C are treated with special coatings.
When improved electromagnetic shielding is required, EMC S-TYPE enclosures are available, provided by an electrically conductive, corrosion resistant and RoHS 2 conform surface treatment.
- 5 **Contact position** identified with numbers or codes on both sides of each insert and printed with a laser system or by mould.
- 6 **CE marking** attesting conformity to the requirements of the Low Voltage directive (2014/35/EU).
- 7 **Inserts** are made of UL certified self-extinguishing fibreglass reinforced thermoplastics, and feature an operating temperature range between -40 °C and +125 °C. The inserts CME (all) and CMCE (only 16+2 poles) for 830V have a key that prevents the insertion of inserts for use other than that prescribed (types CM - Pg and MM - metric). For some series, inserts in PPS (polyphenylene sulphide) are available for special uses with temperatures of up to 180 °C.
- 8 Insert **polarised profiles** with asymmetrical guides to avoid incorrect matings. Inserts have a mechanical life equal to or higher than 500 mating cycles.
- 9 Inserts and enclosures are manufactured in compliance with European standard **EN 61984** (DIN VDE 0627), certified and identified with **UL** (cULus or UL) and **CSA** marks.
- 10 Stainless steel **locking levers and springs** guarantee a perfect closure and a tight sealing.
- 11 Special **sealing gaskets** in vinyl nitrile elastomer, polyurethane or fluoroelastomer (on R-TYPE enclosures for use with maximum temperatures of 180 °C, on W-TYPE enclosures for aggressive environments and on E-Xtreme® enclosures for ultimate resistance to corrosion and erosion), anti-aging, oil-resistant, fuel-resistant, together with the cable entry devices (not supplied) provide a degree of protection (IP code per EN IEC 60529 and Enclosure Type Rating per ANSI/UL 50E) for coupled connectors. Special conductive sealing gaskets for S-TYPE EMC enclosures.
- 12 **Locking device** available in two versions, simple (with one locking lever), or double (with two locking levers). In metallic enclosures, ILME offers different types of locking levers: vertical (V-TYPE) or classic (C-TYPE) rotational closure.
- 13 Various **handle** solutions are available: in self-extinguishing thermoplastic material; in die-cast aluminium, or by stainless steel (either integral or built-in with the lever).
- 14 **Pins and locking levers** (C-TYPE as shown in picture) supplied with anti-friction rolls that facilitate closure and limit wear and tear.
- 15 Captive **insert fastening screws**, with anti-slackening spring washer or under-head knurling.
- 16 **Silver or gold plated brass contacts** connected to the wires by means of captive screws supplied already slackened (screw-type connectors), with spring-clamp terminal (spring connectors), spring-clamp terminals already open with actuator button (SQUICH®, as shown in picture), by means of crimping (contacts available separately), or with a built-in 45° terminal block (in turn with screw-type or spring-clamp terminals).
- 17 Protective **earth terminal** with a wide contact surface.



Find more
information on
our products at
www.ilme.com

STANDARD INSERTS

Inserts are made of UL 94V-0 self-extinguishing thermoplastic resin, normally for use with a maximum ambient temperature of 125 °C; special versions made of >PPS< for use with a maximum ambient temperature of 180 °C. Screw, crimp or spring connections are available. Contacts are in silver or gold plated brass. Inserts are numbered on both sides by laser marking or moulded.

The large number of inserts versions is selected on the basis of rated voltage (50V - 5000V), rated current (5A - 200A max), number of poles and different load combinations required (power and signal poles within the same insert). Inserts are approved in accordance with the applicable safety standards by several third party agencies like UL, CSA, DNV-GL, Bureau Veritas, CQC and EAC. For certifications refer to the summary statement in this catalogue.

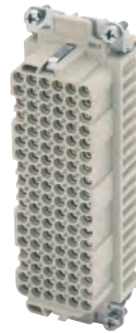
SCREW

CNE



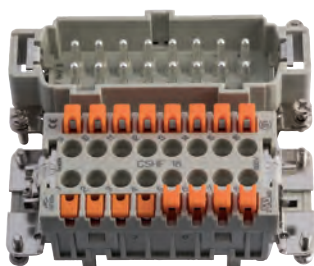
CRIMP

CD - CDD

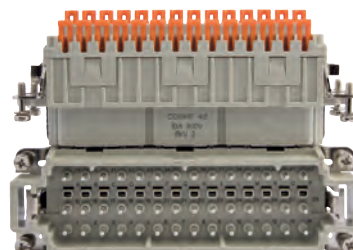


SQUICH® - SPRING

CSH



CDSH



MIXO MODULAR UNITS

The MIXO series is a system composed of modular connector inserts and ancillary parts, able to create a wide diversity of tailored connector solutions, and to satisfy the most specific application needs using the traditional rectangular heavy-duty connector enclosures.

Inside a single enclosure it is possible to house various connections of different nature, for example lines for electrical signals (analogue or high-speed digital), electric power lines, quick coupling contacts for conducting compressed air with pressures of up to 8 bar, fibre optic contacts, Ethernet, USB and coaxial networks.

Insert compartments are composed by placing multiple MIXO modules side by side by locking them each other through specific dovetail shaped keys and keyways, to form a single compact block, much easier to handle and fix to the frame than individual "floating" modules; this block is then inserted in a suitably sized MIXO metal frame with predetermined locking slots. Once the single block of modules has been inserted in the frame and locked with the two special locking keys accompanying each MIXO frame, the connector composed in this manner can be inserted and fixed into the chosen enclosure.

CRIMP, SPRING, SCREW

MIXO 4A - 5A
10A - 16A - 40A



CRIMP

MIXO 70A
100A - 200A



CRIMP

MIXO BUS



MIXO POF/MOST®



MIXO COAX, HT, RJ45
D-SUB, USB, PNEUMATIC



INSERTS FEATURES

Inserts	No. of poles ¹⁾	Aux. contacts	Rated current ²⁾	EN 61984 (2009-06) pollution degree 3			EN 61984 (2009-06) pollution degree 2			UL/CSA certification
				Rated voltage	Rated impulse voltage	Pollution degree	Rated voltage	Rated impulse voltage	Pollution degree	
Series	Main contacts + PE									
CK	3, 4	---	10A	230/400V	4kV	3	400/690V	4kV	2	600V
CKS ▲	3, 4	---	10A	400V	4kV	3	690V	4kV	2	600V
CKSH	3, 4	---	10A	400V	4kV	3	690V	4kV	2	600V
CD	8 (without PE)	---	10A	50V ac / 120V dc	0,8kV	3	---	---	---	50V ac / 120V dc
CD ◆	7, 15, 25, (50), 40, (80), 64, (128)	---	10A	250V ○	4kV	3	230/400V **)	4kV	2	600V
RD (HNM)	40, 64	---	10A	250V	4kV	3	230/400V	4kV	2	600V
CT	40, 64	---	10A	250V	4kV	3	230/400V	4kV	2	600V
CTS	40, 64	---	10A	250V	4kV	3	230/400V	4kV	2	600V
CDD	24, 38, (76), 42, 72, (144), 108, (216)	---	10A	---	---	---	250V	4kV	2	600V
RDD (HNM)	24, 42, 72, 108	---	10A	---	---	---	250V	4kV	2	600V
CDS ▲	9, 18, 27, (54), 42, (84)	---	10A	400V	6kV	3	400/690V	6kV	2	600V
CDSH	9, 18, 27, (54), 42, (84)	---	10A	400V	6kV	3	400/690V	6kV	2	600V
CDSH NC	6 (AutoShort NC 6A)	---	6A	250V	4kV	3	500V	4kV	2	600V
CDA	10, 16, (32)	---	16A	250V	4kV	3	230/400V	4kV	2	600V
CDC	10, 16, (32)	---	16A	250V	4kV	3	230/400V	4kV	2	600V
CSAH	10, 16, (32)	---	16A	250V	4kV	3	400V	4kV	2	600V
CQE	10, 18, (20), 32, 46, (64), (92)	---	16A	500V **)	6kV	3	830V **)	8kV	2	600V
CQEE	40, 64	---	16A	500V	6kV	3	---	---	---	600V
RQEE (HNM)	40, 64	---	16A	500V	6kV	3	---	---	---	600V
CCE	6, 10, (12), 16, 24, (32), (48)	---	16A	500V	6kV	3	400/690V	6kV	2	600V
RCE (HNM)	6, 10, 16, 24	---	16A	500V	6kV	3	400/690V	6kV	2	600V
CNE	6, (12), 10, 16, (32), 24, (48)	---	16A	500V	6kV	3	400/690V	6kV	2	600V
CSE ▲	6, (12), 10, 16, (32), 24, (48)	---	16A	500V	6kV	3	400/690V	6kV	2	600V
CSH	6, (12), 10, 16, (32), 24, (48)	---	16A	500V	6kV	3	400/690V	6kV	2	600V
CSH ... S	6, (12), 10, 16, (32), 24, (48)	---	16A	500V	6kV	3	400/690V	6kV	2	600V
CSS	6, (12), 10, 16, (32), 24, (48)	---	16A	500V	6kV	3	400/690V	6kV	2	600V
CT	6, (12), 10, 16, 24	---	16A	230/400V	4kV	3	400V	4kV	2	600V
CTSE	6, (12), 10, 16, 24	---	16A	500V	6kV	3	400/690	6kV	2	600V
CME ▲ ●	3, 6, 10, (12), (20), (32) 16 ---	---	16A	830V	8kV	3	1000V	8kV	2	600V
				---	720/1250V	8kV	2	---		
				400/690V	6kV	3	---	---	---	
CMSE ▲	3, 6, (12), 10, (20) ---	---	16A	830V	8kV	3	1000V	8kV	2	600V
				---	500V	6kV	3	---	---	
CMSH	3, 6, (12), 10, (20) ---	---	16A	830V	8kV	3	1000V	8kV	2	600V
				---	500V	6kV	3	---	---	
CMCE	3, 6, (12), 10, (20) 16 ▲, (32) ▲ ---	---	16A	830V	8kV	3	1000V	8kV	2	600V
				---	720/1250V	8kV	2	---		
				400/690V	6kV	3	---	---	---	
---	---	2, (4)	---	500V	6kV	3	---	---	---	

▲ Available upon request.

● CME series requires the CM-MM enclosures with additional insulation (available upon request) or T-TYPE insulated enclosures.

☞ All inserts with built-in contacts are provided with silver plated contacts, unless otherwise specified.

Inserts	Certifications ³⁾	Contact resistance	Insulation resistance	Ambient temperature limit (°C) ⁴⁾		Degree of protection without enclosures	Conductor connection technology					From page	
							Axial screw	Screw	Spring	SQUICH®	45° terminal block		Crimp
Series													
CK	UL, CSA, CQC, DNV-GL, BV, EAC	≤ 2 mΩ	≥ 10 GΩ	-40	+100	IP20 ⁵⁾		•					58
CKS ▲	cUL, CSA, CQC, DNV-GL, BV, EAC	≤ 3 mΩ	≥ 10 GΩ	-40	+125	IP20 ⁵⁾			•				-
CKSH	cUL, (CSA), (CQC), DNV-GL, BV, EAC	≤ 3 mΩ	≥ 10 GΩ	-40	+125	IP20 ⁵⁾				•			63
CD	cUL, CSAc, CQC, DNV-GL, BV, EAC	≤ 3 mΩ	≥ 10 GΩ	-40	+125	IP20 ⁵⁾						•	67
CD *)	cUL, CSAc, CQC, DNV-GL, BV, EAC	≤ 3 mΩ	≥ 10 GΩ	-40	+125	IP20 ⁵⁾						•	66
RD (HNM)	(UL), (CSA), (CQC), DNV-GL, BV, EAC	≤ 3 mΩ	≥ 10 GΩ	-40	+125	IP20 ⁵⁾						•	208
CT	UL, CSA, CQC, DNV-GL, BV, EAC	≤ 4 mΩ	≥ 10 GΩ	-40	+125	IP20 ⁵⁾		•			•		156
CTS	UL, CSAc, CQC, DNV-GL, BV, EAC	≤ 4 mΩ	≥ 10 GΩ	-40	+125	IP20 ⁵⁾			•		•		156
CDD	cUL, CSAc, CQC, DNV-GL, BV, EAC	≤ 3 mΩ	≥ 10 GΩ	-40	+125	IP20 ⁵⁾						•	76
RDD (HNM)	(UL), (CSA), (CQC), DNV-GL, BV, EAC	≤ 3 mΩ	≥ 10 GΩ	-40	+125	IP20 ⁵⁾						•	210
CDS ▲	UL, CSA, CQC, DNV-GL, BV, EAC	≤ 3 mΩ	≥ 10 GΩ	-40	+125	IP20 ⁵⁾			•				-
CDSH	UL, (CSA), (CQC), DNV-GL, BV, EAC	≤ 3 mΩ	≥ 10 GΩ	-40	+125	IP20 ⁵⁾				•			86
CDSH NC	UL, (CSA), (CQC), DNV-GL, BV, EAC	≤ 3 mΩ	≥ 10 GΩ	-40	+125	IP20 ⁵⁾				•			95
CDA	cUL, CSA, CQC, DNV-GL, BV, EAC	≤ 1 mΩ	≥ 10 GΩ	-40	+125	IP20 ⁵⁾		•					98
CDC	cUL, CSA, CQC, DNV-GL, BV, EAC	≤ 1 mΩ	≥ 10 GΩ	-40	+125	IP20 ⁵⁾						•	104
CSAH	cUL, (CQC), DNV-GL, BV, EAC	≤ 3 mΩ	≥ 10 GΩ	-40	+125	IP20 ⁵⁾				•			99
CQE	cUL, CSA, CQC, DNV-GL, BV, EAC	≤ 1 mΩ	≥ 10 GΩ	-40	+125	IP20 ⁵⁾						•	168
CQEE	cUL, CSA, CQC, DNV-GL, BV, EAC	≤ 1 mΩ	≥ 10 GΩ	-40	+125	IP20 ⁵⁾						•	176
RQEE (HNM)	(UL), (CSA), (CQC), DNV-GL, BV, EAC	≤ 1 mΩ	≥ 10 GΩ	-40	+125	IP20 ⁵⁾						•	218
CCE	UL, CSA, CQC, DNV-GL, BV, EAC	≤ 1 mΩ	≥ 10 GΩ	-40	+125	IP20 ⁵⁾						•	130
RCE (HNM)	(UL), (CSA), (CQC), DNV-GL, BV, EAC	≤ 1 mΩ	≥ 10 GΩ	-40	+125	IP20 ⁵⁾						•	214
CNE	cUL, CSA, CQC, DNV-GL, BV, EAC	≤ 1 mΩ	≥ 10 GΩ	-40	+125	IP20 ⁵⁾		•					110
CSE ▲	cUL, CSA, CQC, DNV-GL, BV, EAC	≤ 3 mΩ	≥ 10 GΩ	-40	+125	IP20 ⁵⁾			•				-
CSH	cUL, CSA, CQC, DNV-GL, BV, EAC	≤ 3 mΩ	≥ 10 GΩ	-40	+125	IP20 ⁵⁾				•			110
CSH ... S	cUL, (CSA), (CQC), (DNV-GL), (BV), (EAC)	≤ 3 mΩ	≥ 10 GΩ	-40	+125	IP20 ⁵⁾				•			122
CSS	UL, CSA, CQC, DNV-GL, BV, EAC	≤ 3 mΩ	≥ 10 GΩ	-40	+125	IP20 ⁵⁾			•				148
CT	UL, CSA, CQC, DNV-GL, BV, EAC	≤ 4 mΩ	≥ 10 GΩ	-40	+125	IP20 ⁵⁾		•			•		160
CTSE	UL, CSAc, CQC, DNV-GL, BV, EAC	≤ 4 mΩ	≥ 10 GΩ	-40	+125	IP20 ⁵⁾			•		•		160
CME ▲ ●	UL, CSA, CQC, DNV-GL, BV, EAC	≤ 1 mΩ	≥ 10 GΩ	-40	+125	IP20 ⁵⁾		•					-
CMSE ▲	UL, CSA, CQC, DNV-GL, BV, EAC	≤ 3 mΩ	≥ 10 GΩ	-40	+125	IP20 ⁵⁾			•				-
CMSH	cUL, (CSA), (CQC), DNV-GL, BV, EAC	≤ 3 mΩ	≥ 10 GΩ	-40	+125	IP20 ⁵⁾				•			136
CMCE	UL, CSA, CQC, DNV-GL, BV, EAC	≤ 1 mΩ	≥ 10 GΩ	-40	+125	IP20 ⁵⁾						•	137

¹⁾ Polarities shown in brackets may be achieved by using two inserts.

²⁾ Please check the insert load curves to establish the actual maximum operating current according to the ambient temperature.

³⁾ The certifications shown in brackets are being applied for.

⁴⁾ It may be used with ambient temperatures up to 180 °C by using the insert special version made of PPS (polyphenylene sulfide).

⁵⁾ IPXXB.

◆ CD 07: IP67 with thermoplastic enclosures (cannot be used with metal enclosures).

● Contacts partially fitted inside an insert allow inserts to be used for applications requiring rated voltages higher than those shown. See CD, CDD, CQE inserts relevant tables.

INSERTS FEATURES

Inserts	No. of poles ¹⁾	Aux. contacts	Rated current ²⁾	EN 61984 (2009-06) pollution degree 3			EN 61984 (2009-06) pollution degree 2			UL/CSA certification
				Rated voltage	Rated impulse voltage	Pollution degree	Rated voltage	Rated impulse voltage	Pollution degree	Rated voltage AC or DC
CP	6, (12)	---	35A	400/690V	6kV	3	---	---	---	600V
CQ 21	21 (without PE)	---	6,5A	50V ac / 120V dc	0,8kV	3	---	---	---	50V ac / 120V dc
CQ 07	7	---	10A	400V	6kV	3	---	---	---	600V
CQ 12	12	---	10A	400V	6kV	3	400/690V	6kV	2	600V
CQ 05	5	---	16A	230/400V	4kV	3	320/500V	4kV	2	600V
CQ4 02	2	---	40A	400V	6kV	3	---	---	---	600V
CQ4 02 H	2	---	40A	830V	6kV	3	---	---	---	600V
CQ4 03	3	---	40A	400V	6kV	3	---	---	---	600V
CQ 17	17	---	10A	160V	2,5kV	3	250V	4kV	2	250V
CQ 08	8	---	16A	500V	6kV	3	400/690V	6kV	2	600V
CQ 04/2	4 + PE	---	40A	400/690V	6kV	3	---	---	---	600V
	---	2	10A	250V	4kV	3	---	---	---	
CX 8/24	8	---	16A	230/400V	4kV	3	400V	4kV	2	600V
	---	24	10A	160V	2,5kV	3	250V	4kV	2	
CX 6/12	6 + PE	---	40A	690V	8kV	3	---	---	---	600V
	---	12	10A	230/400V	4kV	3	---	---	---	
CX 6/36	6	---	40A	690V	8kV	3	---	---	---	600V
	---	36	10A	160V	2,5kV	3	250V	4kV	2	
CX 12/2	12	---	40A	690V	8kV	3	---	---	---	600V
	---	2	10A	---	---	---	250V	4kV	3	
RX 12/2 (HNM)	12	---	40A	690V	8kV	3	---	---	---	600V
	---	2	10A	---	---	---	250V	4kV	3	
CX 6/6	6 + PE	---	100A	690V	8kV	3	---	---	---	600V
	---	6	16A	400V	6kV	3	---	---	---	
CX 4/0	4	0	80A	830V	8kV	3	---	---	---	600V
CX 4/2	4	---	80A	830V	8kV	3	---	---	---	600V
	---	2	16A	400V	6kV	3	400/690V	6kV	2	
CX 4/8	4	---	80A	400V	6kV	3	400/690V	6kV	2	600V
	---	8	16A	230/400V	4kV	3	400V	4kV	2	
CXL 2/4	2	---	---	---	---	---	---	---	---	600V
	---	4	10A	25V	0,8kV	3	---	---	---	
CLK 04	4 (seats/poles)	---	---	Contacts for glass fibre 50 / 125 µm or 62,5 / 125 µm or for 1 mm Ø POF						
CX 1/2 BD	1 CX 01 B /BC, CX 04 B, CX 08 B ⁴⁾	---	16/10/4A	50V	0,8kV	3	---	---	---	50V
	---	2	10A	50V	0,8kV	3	---	---	---	50V

¹⁾ Polarities shown in brackets may be achieved by using two inserts.

²⁾ Please check the insert load curves to establish the actual maximum operating current according to the ambient temperature.

³⁾ The certifications shown in brackets are being applied for.

⁴⁾ It may be used with ambient temperatures up to 180 °C by using the insert special version made of PPS (polyphenylene sulfide).

⁵⁾ IPXXB.

⁶⁾ IPXXA.

⁴⁾ Multi-axial shielded connectors CX 04 B (4P, 10A) or CX 08 B (8P, 5A) or coaxial connectors CX 01 B (10A) or CX 01 BC (16A).

 All inserts with built-in contacts are provided with silver plated contacts, unless otherwise specified.

Inserts	Certifications ³⁾	Contact resistance	Insulation resistance	Ambient temperature limit (°C) ⁴⁾		Degree of protection without enclosures	Conductor connection technology					From page		
							Axial screw	Screw	Spring	SQUICH®	45° terminal block		Crimp	
CP	UL, CSA, CQC, DNV-GL, BV, EAC	≤ 0,5 mΩ	≥ 10 GΩ	-40	+125	IP20 ⁵⁾		•					178	
CQ 21	cUL, (CSA), DNV-GL, BV	≤ 4 mΩ	≥ 10 GΩ	-40	+125	IP20 ⁵⁾						•	190	
CQ 07	cUL, (CSA), (CQC), DNV-GL, BV, EAC	≤ 3 mΩ	≥ 10 GΩ	-40	+125	IP20 ⁵⁾						•	187	
CQ 12	cUL, CSA, CQC, DNV-GL, BV, EAC	≤ 3 mΩ	≥ 10 GΩ	-40	+125	IP20 ⁵⁾						•	189	
CQ 05	cUL, CSA, CQC, DNV-GL, BV, EAC	≤ 1 mΩ	≥ 10 GΩ	-40	+125	IP20 ⁵⁾						•	186	
CQ4 02	cUL, (CSA), (CQC), DNV-GL, BV, EAC	≤ 0,3 mΩ	≥ 10 GΩ	-40	+125	IP20 ⁵⁾						•	182	
CQ4 02 H	cUL, (CSA), (CQC), DNV-GL, BV, EAC	≤ 0,3 mΩ	≥ 10 GΩ	-40	+125	IP20 ⁵⁾						•	183	
CQ4 03	cUL, (CSA), (CQC), DNV-GL, BV, EAC	≤ 0,3 mΩ	≥ 10 GΩ	-40	+125	IP1X ⁶⁾						•	184	
CQ 17	cUL, (CSA), (CQC), DNV-GL, BV, EAC	≤ 3 mΩ	≥ 10 GΩ	-40	+125	IP20 ⁵⁾						•	193	
CQ 08	cUL, CSA, CQC, DNV-GL, BV, EAC	≤ 3 mΩ	≥ 10 GΩ	-40	+125	IP20 ⁵⁾						•	192	
CQ 04/2	cUL, CSA, CQC, DNV-GL, BV, EAC	≤ 0,3 mΩ	≥ 10 GΩ	-40	+125	IP20 ⁵⁾						•	191	
		≤ 3 mΩ										•		
CX 8/24	UL, CSAc, CQC, DNV-GL, BV, EAC	≤ 1 mΩ	≥ 0 GΩ	-40	+125	IP20 ⁵⁾						•	194	
		≤ 3 mΩ										•		
CX 6/12	cUL, (CSA), (CQC), DNV-GL, BV, EAC	≤ 0,3 mΩ	≥ 10 GΩ	-40	+125	IP20 ⁵⁾						•	197	
		≤ 1 mΩ												
CX 6/36	UL, CSAc, CQC, DNV-GL, BV, EAC	≤ 0,3 mΩ	≥ 0 GΩ	-40	+125	IP20 ⁵⁾						•	198	
		≤ 3 mΩ												
CX 12/2	UL, CSAc, CQC, DNV-GL, BV, EAC	≤ 0,3 mΩ	≥ 10 GΩ	-40	+125	IP20 ⁵⁾						•	199	
		≤ 1 mΩ												
RX 12/2 (HNM)	(cUL), (CSA), (CQC), (DNV-GL), (BV), (EAC)	≤ 0,3 mΩ	≥ 10 GΩ	-40	+125	IP20 ⁵⁾						•	221	
CX 6/6	cUL, CSA, CQC, DNV-GL, BV, EAC	≤ 0,3 mΩ	≥ 10 GΩ	-40	+125	IP20 ⁵⁾						•	206	
		≤ 1 mΩ												
CX 4/0	UL, CSA, CQC, DNV-GL, BV, EAC	≤ 0,3 mΩ	≥ 10 GΩ	-40	+125	IP20 ⁵⁾		•					200, 202	
CX 4/2	UL, CSA, CQC, DNV-GL, BV, EAC	≤ 0,3 mΩ	≥ 10 GΩ	-40	+125	IP20 ⁵⁾						•	201, 203	
		≤ 1 mΩ												
CX 4/8	UL, CSA, CQC, DNV-GL, BV, EAC	≤ 0,3 mΩ	≥ 10 GΩ	-40	+125	IP20 ⁵⁾						•	204	
		≤ 1 mΩ												
CXL 2/4	UL, CSA, DNV-GL, BV	≤ 3 mΩ	≥ 10 GΩ	-40	+70	IP20 ⁵⁾						•	250, 251	
CLK 04	cUL, CSA, DNV-GL, BV	---	≥ 10 GΩ	-40	+70	IP20 ⁵⁾						•	239	
CX 1/2 BD	cUL, CSA, (CQC), DNV-GL, BV	≤ 1 mΩ (CC)	≥ 10 GΩ	-40	+70	IP20 ⁵⁾							•	243
		≤ 3 mΩ (CD)												
		≤ 4 mΩ (CI)												
		≤ 3 mΩ	≥ 10 GΩ											

MIXO INSERTS FEATURES

Inserts	No. of poles ¹⁾	Aux. contacts	Rated current ²⁾	EN 61984 (2009-06) pollution degree 3			EN 61984 (2009-06) pollution degree 2			UL/CSA certification
Series	Main contacts + PE			Rated voltage	Rated impulse voltage	Pollution degree	Rated voltage	Rated impulse voltage	Pollution degree	Rated voltage AC or DC
CX 01 Y	1 (without PE)	---	200A	1000V	8kV	3	920/1600V	8kV	2	600V
CX 01 YPE	PE	---	200A	---	---	3	---	---	---	600V
CX 02 G	2 (without PE)	---	100A	1000V	8kV	3	920/1600V	8kV	2	600V
CX 01 G	1 (without PE)	---	100A	830V	8kV	3	---	---	---	600V
CX 02 7	2 (without PE)	---	70A	1000V	8kV	3	1600V	12kV	2	600V
CX 02 4	2 (without PE)	---	40A	1000V	8kV	3	---	---	---	600V
CX 02 4A	2 (2,5 - 8 mm ²) (without PE)	---	40A	1000V	8kV	3	1600V	12kV	2	600V
CX 02 4B	2 (6 - 10 mm ²) (without PE)	---	40A	1000V	8kV	3	1600V	12kV	2	600V
CX 03 4	3 (without PE)	---	40A	400/690V \diamond	6kV	3	---	---	---	600V
CX 03 4B	3 (without PE)	---	40A	500V \diamond	6kV	3	---	---	---	600V
CX 3/4 XD	3 (without PE)	---	40A	830V	8kV	3	---	---	---	600V
	---	4	10A							
CX 04 X	4 (without PE)	---	40A	830V	8kV	3	1000V	8kV	2	600V
CX 05 S \blacktriangle	5 (without PE)	---	16A	400V	6kV	3	500V	6kV	2	600V
CX 05 SH	5 (without PE)	---	16A	400V	6kV	3	500V	6kV	2	600V
CX 06 C	6 (without PE)	---	16A	500V	6kV	3	400/690V	6kV	2	600V
CX 06P C	6 protected (without PE)	---	16A	830V	8kV	3	---	---	---	600V
CX 08 C	8 (without PE)	---	16A	400V	6kV	3	400/690V	6kV	2	600V
CX 20 C	20 (without PE)	---	16A	500V	6kV	3	830V	8kV	2	600V
CX 12 D	12 (without PE)	---	10A	250V	4kV	3	---	---	---	600V
CX 17 D	17 (without PE)	---	10A	160V	2,5kV	3	250V	4kV	2	250V
CX 42 D	42 (without PE)	---	10A	150V	2,5kV	3	---	---	---	250V
CX 02 H	2 (without PE)	---	16A	2900/5000V	15kV	3	---	---	---	---
CX 02 CH	2 (without PE)	---	16A	2500V	15kV	3	---	---	---	---
CX 25 I \blacktriangle \odot	25 (without PE)	---	4A	50V	0,8kV	3	160V	2,5kV	2	600V
CX 25 IB	25 (without PE)	---	4A	50V	0,8kV	3	160V	2,5kV	2	600V
CX 03 P	3	---	---	pneumatic contacts for compress air up to 8 bar						
CX 02 P	2	---	---	---	---	---	---	---	---	---
CX 02 B	2 \odot (without PE)	---	---	50V	0,8kV	3	---	---	---	50V
CX 01 B	1 (+ shield) (75 Ω coax)	---	10A	50V	0,8kV	3	---	---	---	50V
CX 01 BC	1 (+ shield) (50 Ω coax)	---	16A	50V	0,8kV	3	---	---	---	50V
CX 04 B	4 (+ shield)	---	10A	50V	0,8kV	3	---	---	---	50V
CX 08 B	8 (+ shield)	---	5A	50V	0,8kV	3	---	---	---	50V
CX 08 I6	8 (+ shield)	---	5A	50V	0,8kV	3	---	---	---	50V
CX 01 J	1 RJ45 insert Cat. 5	---	---	---	---	---	---	---	---	50V
	---	4	10A	250V	4kV	3	---	---	---	600V
CX 02 J	2 RJ45 inserts Cat. 5	---	---	---	---	---	---	---	---	50V
	---	8	10A	250V	4kV	3	---	---	---	600V
CX 01 J8	1 RJ45 insert Cat. 6	---	1A	50V	0,8kV	3	---	---	---	50V
CX 01 U	1 USB insert	---	1A	50V	0,8kV	3	---	---	---	(50V)
CX 01 9V	9 (+ shield)	---	5A	50V	0,8kV	3	---	---	---	(50V)
CX 01 9VTF	2 (+ shield) for RS-485 bus T-connections	---	5A	50V	0,8kV	3	---	---	---	(50V)
CX 04 L	4	---	---	contacts for POF or MOST [®] fibre optic contacts DIN 41626-3						
CX 04 R	4	---	1,5A	50V	0,8kV	3	crimp coaxial contacts DIN 41626-T2			---
CX 04 SC	4 (seats/poles)	---	---	contacts for glass fibre optic of 50 / 125 μ m or 62,5 / 125 μ m or for POF of 1 mm \varnothing						

 \blacktriangle Available upon request.¹⁾ Polarities shown in brackets may be achieved by using two inserts.²⁾ Please check the insert load curves to establish the actual maximum operating current according to the ambient temperature.³⁾ The certifications shown in brackets are being applied for.⁴⁾ It may be used with ambient temperatures up to 180 °C by using the insert special version made of PPS (polyphenylene sulfide).⁵⁾ IPXXB.

Inserts	Certifications ³⁾	Contact resistance	Insulation resistance	Ambient temperature limit (°C) ⁴⁾		Degree of protection without enclosures	Conductor connection technology					From page	
							Axial screw	Screw	Spring	SQUICH®	45° terminal block		Crimp
CX 01 Y	cUL, CSA, CQC, DNV-GL, BV, EAC	≤ 0,2 mΩ	≥ 10 GΩ	-40	+125	IP20 ⁵⁾						•	262
CX 01 YPE	cUL, CSA, CQC, DNV-GL, BV, EAC	≤ 0,2 mΩ	≥ 10 GΩ	-40	+125	IP20 ⁵⁾						•	263
CX 02 G	UL, CSA, CQC, DNV-GL, EAC	≤ 0,3 mΩ	≥ 10 GΩ	-40	+125	IP20 ⁵⁾						•	265
CX 01 G	(UL), (CSA), (CQC), DNV-GL, BV, EAC	≤ 0,3 mΩ	≥ 10 GΩ	-40	+125	IP20 ⁵⁾						•	264
CX 02 7	cUL, CSAc, CQC, DNV-GL, BV, EAC	≤ 0,5 mΩ	≥ 10 GΩ	-40	+125	IP20 ⁵⁾						•	266
CX 02 4	UL, (CSA), CQC, DNV-GL, BV, EAC	≤ 0,3 mΩ	≥ 10 GΩ	-40	+125	IP20 ⁵⁾						•	267, 321
CX 02 4A	UL, CSA, CQC, DNV-GL, BV, EAC	≤ 0,5 mΩ	≥ 10 GΩ	-40	+125	IP20 ⁵⁾	•						268
CX 02 4B	UL, CSA, CQC, DNV-GL, BV, EAC	≤ 0,5 mΩ	≥ 10 GΩ	-40	+125	IP20 ⁵⁾	•						268
CX 03 4	cUL, CSA, CQC, DNV-GL, BV, EAC	≤ 0,3 mΩ	≥ 10 GΩ	-40	+125	IP20 ⁵⁾						•	269, 322
CX 03 4B	cUL, CSA, CQC, DNV-GL, BV, EAC	≤ 0,3 mΩ	≥ 10 GΩ	-40	+125	IP20 ⁵⁾						•	270, 323
CX 3/4 XD	cUL, CSA, CQC, DNV-GL, BV, EAC	≤ 0,3 mΩ	≥ 10 GΩ	-40	+125	IP20 ⁵⁾						•	271, 324
		≤ 3 mΩ											
CX 04 X	cUL, CSA, CQC, DNV-GL, BV, EAC	≤ 3 mΩ	≥ 10 GΩ	-40	+125	IP20 ⁵⁾			•				272, 325
CX 05 S ▲	UL, CSA, CQC, DNV-GL, BV, EAC	≤ 3 mΩ	≥ 10 GΩ	-40	+125	IP20 ⁵⁾			•				-
CX 05 SH	(cUL), (CSA), (CQC), (DNV-GL), (BV), (EAC)	≤ 3 mΩ	≥ 10 GΩ	-40	+125	IP20 ⁵⁾				•			274
CX 06 C	UL, CSA, CQC, DNV-GL, BV, EAC	≤ 1 mΩ	≥ 10 GΩ	-40	+125	IP20 ⁵⁾						•	275, 327
CX 06P C	(UL), (CSA), (CQC), DNV-GL, BV, EAC	≤ 1 mΩ	≥ 10 GΩ	-40	+125	IP20 ⁵⁾						•	276, 326
CX 08 C	UL, CSA, CQC, DNV-GL, BV, EAC	≤ 1 mΩ	≥ 10 GΩ	-40	+125	IP20 ⁵⁾						•	277, 328
CX 20 C	cUL, CSA, CQC, DNV-GL, BV, EAC	≤ 1 mΩ	≥ 10 GΩ	-40	+125	IP20 ⁵⁾						•	278, 329
CX 12 D	UL, CSAc, CQC, DNV-GL, BV, EAC	≤ 3 mΩ	≥ 10 GΩ	-40	+125	IP20 ⁵⁾						•	281, 330
CX 17 D	cUL, CSAc, CQC, DNV-GL, BV, EAC	≤ 3 mΩ	≥ 10 GΩ	-40	+125	IP20 ⁵⁾						•	282, 331
CX 42 D	cUL, (CSA), (CQC), (DNV-GL), (BV), (EAC)	≤ 3 mΩ	≥ 10 GΩ	-40	+125	IP20 ⁵⁾						•	283, 332
CX 02 H	(cUL), (CSA), (CQC), (DNV-GL), (BV), (EAC)	≤ 1 mΩ	≥ 10 GΩ	-40	+125	IP20 ⁵⁾						•	280
CX 02 CH	(cUL), (CSA), (CQC), (DNV-GL), (BV), (EAC)	≤ 1 mΩ	≥ 10 GΩ	-40	+125	IP20 ⁵⁾						•	279
CX 25 I ▲	cUL, CSA, DNV-GL, BV	≤ 4 mΩ	≥ 10 GΩ	-40	+125	IP20 ⁵⁾						•	-
CX 25 IB	(UL), (CSA), DNV-GL, BV	≤ 4 mΩ	≥ 10 GΩ	-40	+125	IP20 ⁵⁾						•	284
CX 03 P	UL, CSA, DNV-GL, BV	---	≥ 10 GΩ	-40	+80	IP20 ⁵⁾	snap-in					312	
CX 02 P	UL, CSA, DNV-GL, BV	---	≥ 10 GΩ	-40	+80	IP20 ⁵⁾	snap-in					312	
CX 02 B	UL, CSA, CQC, DNV-GL, BV	---	≥ 10 GΩ	-40	+125	IP20 ⁵⁾	snap-in					288 - 292	
CX 01 B	UL, CSA, CQC, DNV-GL, BV	≤ 3 mΩ	≥ 10 GΩ	-40	+85	IP20 ⁵⁾						•	291
CX 01 BC	UL, CSA, CQC, DNV-GL, BV	≤ 1 mΩ	≥ 10 GΩ	-40	+85	IP20 ⁵⁾						•	289
CX 04 B	UL, CSA, CQC, DNV-GL, BV	≤ 3 mΩ	≥ 10 GΩ	-40	+85	IP20 ⁵⁾						•	291
CX 08 B	UL, CSA, (CQC), DNV-GL, BV	≤ 4 mΩ	≥ 10 GΩ	-40	+85	IP20 ⁵⁾						•	293
CX 08 16	cUL, (CSA), (CQC), (DNV-GL), (BV)	≤ 4 mΩ	≥ 10 GΩ	-40	+85	IP20 ⁵⁾						•	286
CX 01 J	cUL, CSA, CQC, DNV-GL, BV, EAC	≤ 3 mΩ	≥ 10 GΩ	-40	+120	IP20 ⁵⁾						•	304
		≤ 3 mΩ	≥ 10 GΩ	-40	+120	IP20 ⁵⁾						•	
CX 02 J	cUL, CSA, CQC, DNV-GL, BV, EAC	≤ 3 mΩ	≥ 10 GΩ	-40	+120	IP20 ⁵⁾						•	306
CX 01 J8	cUL, (CSA), DNV-GL, BV, EAC	≤ 3 mΩ	≥ 10 GΩ	-40	+70	IP20 ⁵⁾						•	302
CX 01 U	cUL, CSA, DNV-GL, BV	≤ 3 mΩ	≥ 10 GΩ	-25	+80	IP20 ⁵⁾						•	294
CX 01 9V	---	---	≥ 10 GΩ	-40	+70	IP20 ⁵⁾						•	296
CX 01 9VTF	---	---	≥ 10 GΩ	-40	+70	IP20 ⁵⁾		•					298
CX 04 L	cUL, CSA, (CQC), DNV-GL, BV, EAC	≤ 30 mΩ	≥ 1 GΩ	-40	+85	IP20 ⁵⁾							299
CX 04 R	cUL, (CSA), DNV-GL, BV		≥ 5 GΩ	-40	+125	IP20 ⁵⁾						•	300
CX 04 SC	cUL, (CSA), DNV-GL, BV	---	≥ 10 GΩ	-40	+85	IP20 ⁵⁾						•	301

◆ With cable Ø up to 5 mm (CX 03 4), with cable Ø up to 7,5 mm (CX 03 4B).

● Multi-axial shielded connectors CX 04 B (4P, 10A) or CX 08 B (8P, 5A) or coaxial connectors CX 01 B (10A) or CX 01 BC (16A).

■ Centre contact resistance ≤ 10 mΩ; outer contact resistance ≤ 3 mΩ.

○ Suitable for CI crimp contacts up to size 0.5.

☑ All inserts with built-in contacts are provided with silver plated contacts, unless otherwise specified.

RECOMMENDED TIGHTENING TORQUE

- insert terminal screws, including PE terminal and fixing screws
- axial screw insert, MIXO series CX 02 4A / CX 02 4B
- enclosures assembly screws

Insert terminal screws, including PE terminal and fixing screws

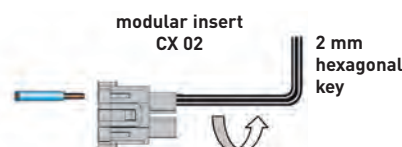
Increasing the tightening torque of terminal screws does not considerably improve the contact resistance. The screw torques are selected according to standard EN 60999-1, to provide excellent mechanical, thermal and electric behaviour. The conductor or terminal may be damaged if the recommended values are significantly exceeded.

Screw size	Connector type	Recommended tightening torque		Recommended size of screwdriver
		(Nm)	(lb.in)	
LINE TERMINALS				
M2,5	CT 40, 64	0,4	3,5	0,5 x 3
M2,6	CT 06..24	0,4	3,5	0,5 x 3
M3	CK	0,5	4,4	0,5 x 3
M3	CDA	0,5	4,4	Ph0 or 0,6 x 3,5
M3	CNE, CME	0,5	4,4	Ph0 or 0,8 x 4
M3	CX 4/2, CX 4/8 (16A)	0,5	4,4	0,6 x 3,5
M3	CX 4/8 Q (16A)	0,5	4,4	Ph0
M4	CP	1,2	10,6	Ph1 or 0,8 x 4
M6	CX 4/.. (80A)	2,5	22,1	1,0 x 5,5
PE TERMINAL				
M3	CK, CQ 05, CQ 07, CQ 12	0,5	4,4	0,5x3
M4	all series except CD 15, CD 25, CDA, CDC, CSAH, MIXO	1,2	10,6	Ph2 or 1,0 x 5,5
M3,5	series CD 15, CD 25, CDA, CDC, CSAH	0,8	7,1	Ph1 or 0,8 x 5,5
M3	small PE terminal, MIXO frames series	0,5	4,4	Ph1 or 1,0 x 4,5
M4	large PE terminal, MIXO frames series	1,2	10,6	Ph1 or 1,0 x 5,5
M4	PE terminal, MIXO ONE enclosures	1,2	10,6	Ph1 or 1,0 x 5,5
FASTENING SCREWS				
M3	CK, CKS, CKSH, CD 07, CD 08, CQ 05, CQ 07, CQ 12, CQ 21, CQ4 02 /02 H, CQ4 03, CX 1/2 BD	0,5	4,4	Ph1 or 0,8 x 5,5
M3	screw for fastening inserts to enclosures of all series except T-TYPE, CQ-MQ 08 and MIXO ONE	0,8	7,1	Ph1 or 0,8 x 4
Ø 2,9	screws for fastening "32.13" inserts CQ 04/2, CQ 08, CQ 17 to CQ-MQ 08 enclosures	0,7	6,2	Ph1
M3	screw for fastening inserts to T-TYPE enclosures	0,5	4,4	Ph1 or 0,8 x 4
Ø 2,9	series MIXO ONE enclosures, assembly of top and bottom parts	0,8	7,1	Ph1
M4	CYR 16.3, CYR 24.4 cable pass-through hoods, assembly of two halves	1,2	10,6	Ph2 or 1,0 x 5,5
M4	CYG 16 in-line joint, assembly of two halves and mounting of two bulkhead mounting housings size "77.27"	1,2	10,6	Ph2 or 1,0 x 5,5
M5	series BIG enclosures, assembly of top and bottom parts	1,0	8,8	Ph2

Axial screw insert, MIXO series CX 02 4A / CX 02 4B

The connections of the conductors to the female and male inserts are made via axial screw. Fully insert the stripped wire in the back of the contact (axial screw terminals are supplied fully opened); while holding the wire down, insert a 2 mm hexagonal key in the front of the contact and tighten to recommended torque. After assembling the complete connector periodically check that the contact is screwed tight by re-applying the proper tightening torque.

- Usable conductor cross-sections (EN 60228 Class 5):
 - from 2,5 to 8 mm² (14 AWG to 10 AWG) (CX 02 4AF/M)
 - from 6 to 10 mm² (10 AWG to 8 AWG) (CX 02 4BF/M)
 - (extra-flexible EN 60228 class 6: 2,5... 6 mm² (14 AWG to 10 AWG))
- Use only stranded flexible copper conductors
- Do not twist the strands!
- Tightening torque with 2 mm hexagonal Allen key:
 - 1,5 Nm (13,3 lb.in) max for conductors with section 2,5 ... 4 mm² (14 AWG to 12 AWG)
 - 2 Nm (17,7 lb.in) max for conductors with section 6 ... 10 mm² (10 AWG to 8 AWG)
- Stripping length: 8+1 mm



Enclosures assembly screws

In the table below, the recommended minimum and maximum tightening torque to apply to the fixing screws of ILME bulkhead mounting housings are shown, assuming the use of steel screws with 8.8 resistance class and a good fixing panel surface according to the requirements mentioned therein.

Series	Number of screws	Screw size	Recommended torque		Flange sealing element
			(Nm)	(lb.in)	
CK/MK, CKX, CKA/MKA, CQ	2	M3	0,8 – 1,0	7,1 – 8,9	Gasket
MIXO ONE	4	M3	0,5 – 0,9	4,4 – 8,0	Gasket
CZI 15 /25	4	M3	0,8 – 1,0	7,1 – 8,9	Gasket
CHI 50	4	M4	1,2 – 1,8	10,6 – 15,9	Gasket
CHI 06 /10 /16 /24	4	M4	0,8 – 1,2	7,1 – 8,9	Gasket
CHI 32	4	M4	1,2 – 1,8	10,6 – 15,9	Gasket
CHI 48	4	M6	3,0 – 3,6	26,6 – 31,9	Gasket
CGK/MGK (IP68)	2	M4	0,8 – 1,2	7,1 – 8,9	O-ring
CGI/ MGI 06/ 10/ 16/ 24 (IP68)	2	M6	3,0 – 3,6	26,6 – 31,9	O-ring
T-TYPE, T-TYPE/H, T-TYPE/C, T-TYPE/ W	4	M4	0,8 – 1,2	7,1 – 8,9	Gasket

To guarantee the declared IP degree of protection of the housings reported in this catalogue, according to EN IEC 60529 or to the relevant Type rating per ANSI/UL 50 and 50E (for those products bearing approval to those ratings), the surface of the mounting panel must meet the following requirements (definitions are provided in ISO 4287 standard):

- Waviness $Wt \leq 0,2$ mm over a distance of 200 mm (measured on the panel without load)
- Roughness $Ra \leq 16$ μ m

NOTE: The values of tightening torque indicated in the above table are just recommended values, that must be related – by the designer of the final application – to the resistance class of the screws (not included in the delivery), with the assumption that the mounting panel is sufficiently rigid (stiff). If the deflection of the panel, under the effect of tightening the screws, is greater than 0,7 mm over a distance of 100 mm, it is necessary to use the counter-flanges mentioned in our catalogue or the special flange gaskets available upon request (please contact our Sales Department). For the CGI/MGI IP68 enclosures the specific counter-flanges mentioned in our catalogue are always recommended.

Enclosures locking screws

Series	Number of screws	Screw size	Recommended tightening torque		Recommended size of screwdriver
			(Nm)	(lb.in)	
CGK/MGK	2	M4	1,2	10,6	1,0 x 5,5 or 7 mm hexagonal key
CG/IMG	2	M6	2,5	22,1	1,6 x 10 or 10 mm hexagonal key

RANGE OF CONDUCTOR CROSS-SECTIONAL AREA AND STRIPPING LENGTH

Connector inserts connection technique	Range of conductor cross-sectional area		Stripping length (mm)
	(mm ²)	AWG	
Screw			
CK	0,75 – 2,5	18 – 14	6
CX 4/2, CX 4/8 (poles 16A) ¹⁾	0,75 – 4	18 – 12	7
CNE ¹⁾	0,75 – 2,5	18 – 14	7
CNE..X	0,5 – 4	20 – 12	7
CDA ¹⁾	0,25 – 2,5	24 – 14	7
CDA..X	0,5 – 4	20 – 12	7
CT 06..24	0,25 – 2,5	24 – 14	7
CT 40 and 64	0,75 – 2,5	18 – 14	12
CME ¹⁾	0,75 – 2,5	18 – 14	12
CME..X	0,5 – 4	20 – 12	7
CP ¹⁾	0,5 – 2,5	20 – 14	7
CX 4/.. (80A poles)	0,75 – 6	18 – 10	10,5
CX 4/.. (80A poles)	4 – 16	12 – 5	14
Crimp			
MIXO (5A), CX 25 IB	0,14 – [2,5]*	26 – 14	8 – * [6 for 2,5 mm ²]
CQ 21	0,08 – 0,5	28 – 20	4
CDD, CD, MIXO (10A), CQ 12, CQ 07	0,08 – 0,5	28 – 20	4
CCE, CDC, CMCE, CQ, CQE, CQEE, MIXO (16A)	0,14 – 4	26 – 12	7,5
CX, MIXO (40A), CQ4 03	1,5 – 2,5	16 – 14	9
MIXO (70A)	4 – 6	12 – 10	9,6
MIXO (100A), CX 6/6	10 – 25	7 – 4	15
MIXO (200A)	10 – 35	7 – 2	15
MIXO (200A)	16 – 70	6 – 2/0	15
Spring			
CSE, CSH, CTSE 06..24, CMSH, MIXO [CX 05 S ²⁾ , CX 05 SH], CSS	0,14 – 2,5	26 – 14	9 - 11
CTS 40/64	0,14 – 2,5 unprepared 0,14 – 1 prepared	26 – 14 unprepared 26 – 18 prepared	9 - 11
CKS, CKSH, CDS, CDSH, CSAH	0,14 – 2,5 unprepared 0,14 – 1,5 prepared	26 – 14 unprepared 26 – 16 prepared	9 - 11

¹⁾ For CNE, CDA, CP, CME, "CX 4/8 – pole 16A" series connectors with screw terminal and conductor protection plate, the use of ferrules is not necessary (= unprepared conductor). The use of ferrules (= prepared conductor) causes a reduction in maximum useful cross-section to the lower size (e.g. 4 mm² unprepared - 2,5 mm² prepared).

²⁾ Available upon request.

CONDUCTOR CONNECTION TECHNOLOGY

SCREW

✎ For all inserts with screw terminals it is important that the right torsional torque is applied to the screws in order to prevent wrong contacts or damage to the conductor, the screw or the terminal.

✎ The **10A and 16A crimp contacts** are available either silver or gold-plated.

The **gold-plated crimp contacts** are recommended for applications with very low rated currents and rated voltages. Thanks to the conduction characteristics of gold, the deterioration of signals is prevented and an excellent resistance to the surface oxidation of the contacts is obtained. In particular, gold-plated contacts are recommended with signals with ≤ 5 mA current and ≤ 5 V voltage.

With screw terminal connections with or without wire protection



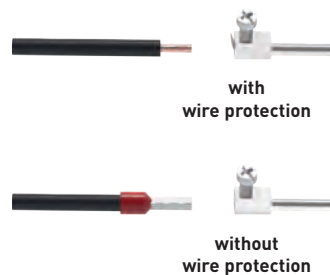
CK - CDA - CNE - CME - CP - CX

The connections of the conductors to the female and male inserts are made via screws (in accordance with standard EN 60999-1).

Two different types of clamping are possible:

- with pressure plate for unprepared conductors;
- without wire protection that requires the conductors to be prepared with bush terminals.

Clamping types

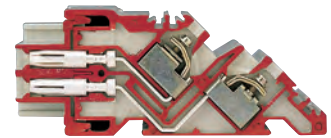


CX..A / CX..B

The connections of the conductors to the female and male inserts is made via screws in accordance with standard.

Fully insert the wire in the back of the contact; insert a 2 mm hexagonal key in the front of the contact and tighten by holding down the cable (page 20).

Screw connected in built-in terminal block



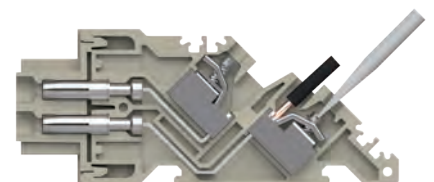
CT

In this layout the wires are connected to the socket and plug insert contacts by means of a screw for all CT inserts (in compliance with EN 60999-1).

The inserts contain:

- a terminal block at 45° for fixed installation on electrical panels or on built-in DIN EN 60715 rail, for easier wire cabling and identification operations
- screw connection with pressure plate which does not require the wires to be prepared (CT inserts).

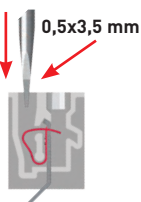
CT connection technology



INCORPORATED TERMINAL BLOCK

Connection technology

step 1
Insert the flat blade screwdriver tip in the dedicated square-shaped cavity provided outside the terminal and push it down perpendicularly to the access surface, up to the bottom. Acting as a wedge, the screwdriver tip pushes forward the spring, to open the wire clamping window.



step 2
Insert the wire previously stripped at the right length all the way down in the round terminal cavity.



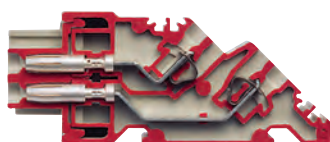
step 3
Remove the screwdriver tip. The spring clamps now the wire in the terminal.



step 4
Pull gently on the wire to ensure that it is firmly clamped in the spring terminal.



Built-in terminal block

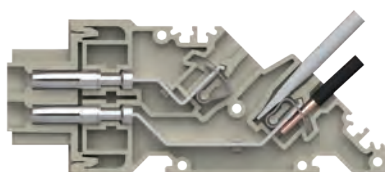


CTSE - CTS

With terminal block at 45° built-in for fixed installation on electrical panels or on built-in DIN EN 60715 rail, for easier wire cabling and identification operations.

Spring terminal connection which does not require wire preparation (CTSE inserts).

CTSE connection technology



Dual spring terminal

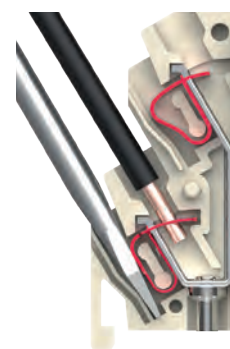


CSS

Equipped with two terminals per contact.

This type of connection allows a circuit to be branched off.

CSS connection technology



0,5 x 3,5 mm blade

SQUICH® - SPRING

Connection without tools

Q The wires are connected to the insert contacts by a spring terminal with patented actuator button.

Key advantages:

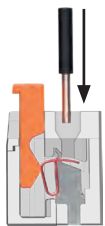
- ☑ No special wire preparation, other than stripping
- ☑ No need for wiring tools
- ☑ Excellent fastening solution and great resistance to strong vibrations
- ☑ Suitable for solid and flexible wires, both ferruled and unferruled, with a cross sectional area range of 0,14 mm² to 2,5 mm²
- ☑ Reduced wiring time, up to 50%
- ☑ Correct wiring can be checked by inserting a test probe into the perforated shape of the actuator buttons

SQUICH® - spring

Connection technology

WIRING

1



Deeply insert a stripped conductor into a round seat.

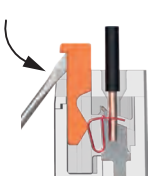
2



Push the actuator button to close the terminal.

RE-OPENING

3



Insert a 0,5 x 3,5 mm flat blade screwdriver in the actuator button side window and pull it up by levering down.

Spring connected contacts with actuator button

SQUICH®



CKSH

All the advantages of SQUICH® connection technology in size "21.21". Vertical and straight termination and dedicated coding pins.

Spring connected contacts with actuator button

SQUICH®



CSH

Parent insert of the connection technology. Quick, simple and safe wiring for a practically error-free installation.

CMSH

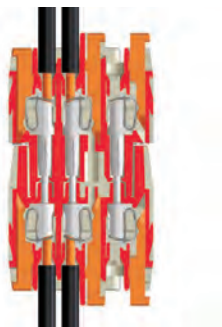
Specific version for voltages up to 830 V. The CMSH inserts can be used with all types of enclosures.



Watch our SQUICH® video

Spring connected contacts with actuator button

SQUICH®

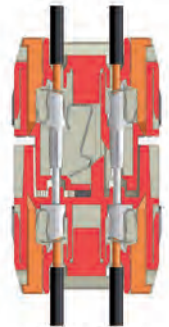


CDSH

High density without tools. The CDSH insert is the answer to the continuous demand for greater number of poles and smaller dimensions. It offers a maximum number of 84 poles in the same space of standard series. Inserts can be coded by CR CDS pin to avoid incorrect coupling.

Spring clamp contacts with actuator button, with NC shorting contacts

SQUICH®



CDSH NC

The AutoShort connector, suitable for interfacing measuring current transformers. 3 pairs of contacts with AutoShort NC (normally closed) element to protect the measuring current transformer's secondary windings. It can be used either with metal or thermoplastics enclosures, size "44.27".

Spring connected contacts with actuator button

SQUICH®



CSAH

This version implements the SQUICH® concept in a miniaturized version with a high contact density. Slim design for 400V needs. Inserts can be mated with CDA/CDC series.

CRIMP

Removable crimp contacts (with retention device)



MIXO 70A - 100A - 200A

This layout enables the wires to be connected to the insert removable contacts by crimping them with a crimp tool and its locating turret. Connection is ensured and is **extremely resistant** even to the most insidious strains, such as vibrations.



MIXO 70A/100A max contacts

Conductor section		Identification
(mm ²)	AWG	hole Ø (mm)
8 - 10	8 - 7	4,3
16	6 - 5	5,5
25	4 - 3	7,0
35	2	7,9 / 8,2

MIXO 200A max contacts

Conductor section		Identification
(mm ²)	AWG	
16	6	
25	4	
35	2	
50	1	
70	2/0	

☑ Contacts supplied in silver plated version only

Removable crimp contacts (with retention device on contacts)



MIXO - CD - CDD - CX

This layout enables the wires to be connected to the insert removable contacts by crimping them with a crimp tool and its locating turret.

The crimped connections are then inserted (with a fitting tool for sizes 1 and 2, without any tools for sizes ②, 3, 4 and 5) in the above mentioned sizes and are kept firmly in place by means of the flexible device fitted on the contacts. The wire housing entry on the contact is tapered to facilitate wire insertion and to avoid any damages occurring after the crimping operation. To remove connections, a special **extractor tool** must be used.

4A/5A/6,5A max contacts

Conductor section		Identification
(mm ²)	AWG	hole Ø (mm)
0,08 - 0,21	28 - 24	0,64 mm
0,13 - 0,33	26 - 22	0,90 mm
0,33 - 0,52	22 - 20	1,12 mm
0,52 - 0,75	20 - 18	1,12 mm

10A max contacts

Conductor section		Number Identification
(mm ²)	AWG	
0.14 - 0.37	26 - 22	
0.5	20	
0.75	18	
1	18	
1.5	16	
2.5	14	

☑ Contacts supplied in both silver/gold plated versions

Removable crimp contacts (with retention device inside insert)



MIXO - CQ - CQE - CCE - CDC - CMCE - CX

The connections of the conductors to the removable contacts of the male and female inserts are made via crimping with a crimping tool and locator. The crimped connections are then introduced in the inserts of the above mentioned series and are **firmly held in place** by means of a retainer device fitted on the insert which holds down the contact. The contact can be removed by simply using a flat head 3 mm screwdriver through the openings provided in the inserts (CMCE 16+2, CX 8/24 series) or by means of special extractor tools, to unlock the retainer device and release the contact (CQ, CCE, CMCE, CQE, CX, CDC, MIXO series). The wire housing entry on the contact is tapered to facilitate wire insertion and to avoid any damages occurring after the crimping operation.

16A max contacts

Conductor section		Throat Identification
(mm ²)	AWG	
0.14 - 0.37	26 - 22	
0.5	20	
0.75	18	
1	18	
1.5	16	
2.5	14	
3	12	
4	12	

☑ Contacts supplied in both silver /gold plated versions. Male contacts can also be supplied in the "advanced" version and iron/constantan contacts for thermocouples J type.

40A max contacts

Conductor section		Identification
(mm ²)	AWG	hole Ø (mm)
1,5	16	1,75
2,5	14	2,25
4	12	2,85
6	10	3,5

☑ MIXO above contacts are supplied in the silver plated version only

CRIMP CONTACTS OVERVIEW

The 4/6,5 A, 10 A and 16 A crimp contacts are available either **silver or gold-plated**. The gold-plated crimp contacts are recommended for applications with very low rated currents and rated voltages.

Thanks to the conduction characteristics of gold, the deterioration of signals is prevented and an excellent resistance to the surface oxidation of the contacts is achieved. In particular, gold-plated contacts are recommended with signals with less than ± 5 mA current and ± 5 V voltage.

Standard ILME **gold treatment** is carried out in accordance with MIL-G-45204C Class 00, Type II, Grade C and ASTM B428-01 Class 0.5, Type II, Grade C.

The basic or high thickness gold-plated contacts are in compliance with EN 61984: 2009, IEC 60512 and EN 60352-2:1994 (such as the standard version)

CRIMP SILVER PLATED

4-6,5 A



10 A



16 A

Normal and for advanced opening



10-40-70-100-200 A



CRIMP GOLD PLATED

10-16 A
Standard



10-16-40 A
HNM (High Number of Matings)



10-16 A
High thickness / Basic



CI 4-6,5 A
For very high density inserts



CRIMP IRON/CONSTANTAN THERMOCOUPLE

Constantan (CuNi) and Iron (Fe)
According to IEC 60584-1 type J



CRIMP POF/MOST

For POF/MOST Optic Fibres
POF 1,0 mm
and MOST 1/1,5 mm



COAXIAL TO CRIMP

50 Ω - 75 Ω
according to DIN 41626-2



LOAD CURVES

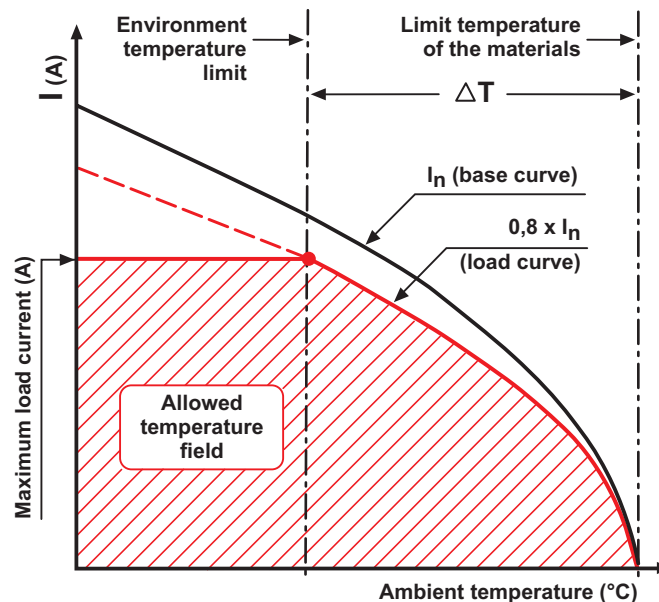
The permitted current carrying capacity for connectors is variable: it becomes lower with the increase of the number of poles and of the ambient temperature in which the connector is installed and it depends upon the thermal properties of the material used for the contacts and the insulating parts including those of the type of conductor used. The current carrying capacity is obtained from the load curves which are constructed according to standard IEC 60512-5-2 for currents circulating simultaneously in all poles.

The limit current curves express current values that determine the achievement of the upper limit temperature of the materials. The choice of the permanent load applicable on the contacts **must be made within the field of operation possible delimited by the above mentioned curves.**

Since use of connectors at the limit values of their characteristics is not recommended, the **base curve** is de-rated. The reduction of the load currents to 80% defines the correction curve where both the maximum permissible contact resistances and the inaccuracy of the temperature measurements are sufficiently taken into consideration.

The correction curve represents the final **limit current curve (load curve)** as defined by standard IEC 60512-5-2. It therefore bears in consideration the differences between the various connector inserts, as well as errors in the temperature measurements.

All the load curves presented in this catalogue include the correction. See figure below.



Legend

Maximum load current (A)

Value for which the connector reaches the upper limit temperature of the material at the corresponding ambient temperature intersected on the load curve.

Limit temperature of the materials

Value determined by the characteristics of the material used. The sum of the environmental temperature and the increase of the ΔT (temperature rise) caused by the current flow must not exceed the limit temperature of the materials.

Environment temperature limit

The environmental conditions must not exceed this value. It may be known and determines the maximum load current, or it may be directly obtained from the load curve.

Base curve

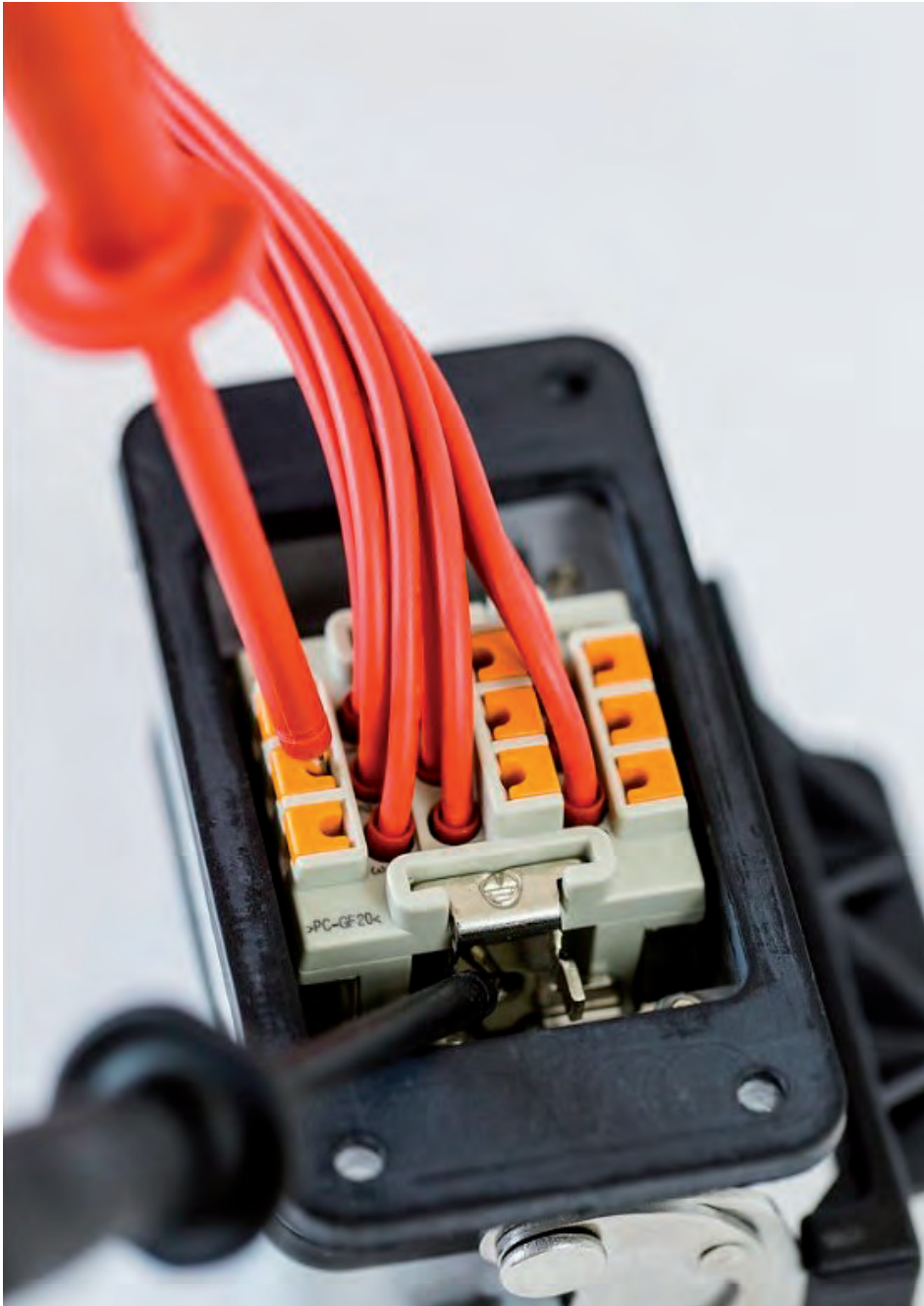
Set of current and temperature values obtained from laboratory tests and influenced by the connector's characteristics (number of poles, construction shape, thermal conductivity of the materials, etc.) and the cross-section of the conductor used.

Load curve (limit current curve)

Obtained from the base curve via the safety coefficient.

ΔT (temperature rise)

Temperature rise produced by a permanent current circulating through all the poles of a connector coupling; difference between the upper limit temperature of the material and the ambient temperature obtained on the limit current curve.



ENCLOSURE TYPES

A large number of enclosure versions is available with different combinations of component materials, each one suitable for specific environmental installation conditions: standard, high temperature, aggressive, extremely aggressive, and electromagnetic compatibility. The principal parts are made in die cast aluminium (or zinc) alloy with a thermosetting powder coating or in self-extinguishing insulating thermoplastic material. They are resistant to impacts and strong mechanical stress.

The coupling's stability and protection against accidental openings are ensured by single or double locking devices comprising levers, springs and pegs – or screws or bayonets – in stainless steel, or entirely in plastic, or in a combination of both. Sealing is ensured by special gaskets that protect the connectors inside the enclosures against dust and aggressive agents. In general, the coupled enclosures with the appropriate user-selected connections guarantee IP44, IP65, IP66 and IP69 (IEC/EN 60529) degrees of protection and some series can reach IP67 and IP68 degree of protection. This catalogue provides for each enclosure the degree of protection and the conditions upon which it applies. The IP degree of protection of the complete connector coupling is the lowest of those assigned to each of the composing parts and is valid only when any cable entry is fitted with suitably rated cable entry device (not included) and upon connectors mated and locked.

STANDARD USE



C-TYPE

The classic choice



IL-BRID

Soft closing, strong hold



T-TYPE

The high-end plastic solution



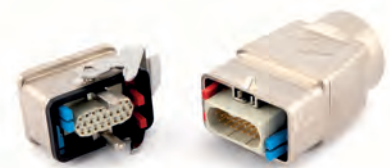
CK - MK - CKA - MKA

The most compact



CQ - MQ

Insulating



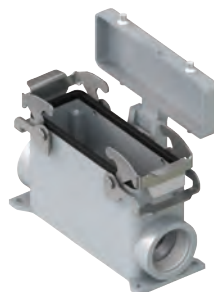
MIXO ONE

Modular by definition

WATERTIGHT IP67



V-TYPE IP66/IP67
Extra tough



C7 IP66/IP67
Vertical closing



CZ7 IP66/IP67
Rigid coupling

WATERTIGHT IP68



CGK - MGK IP68
High protection



IP68
The diving master

AGGRESSIVE ENVIRONMENTS



T-TYPE W
For aggressive environments



W-TYPE
A cornerstone against corrosion



E-Xtreme®
Protection and beyond

SPECIFIC USE



HYGIENIC

Safe for food



LS-TYPE

For Light and Sound



BIG HOODS

The space you have always needed



180 °C

The heat shield



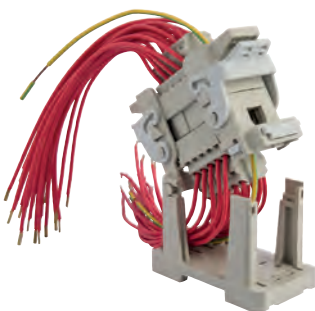
EMC

No interferences



CENTRAL LEVER

Easy access for robotics



COB

Functionality counts



HNM

High number of matings



830V*

High voltage version

* available upon request

APPLICATION SECTORS

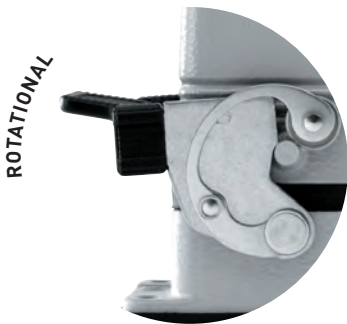
ILME products apply in many different sectors, they are engineered and tested to provide specific solutions for different environments.



LOCKING SYSTEMS

C-TYPE

Classic and flexible

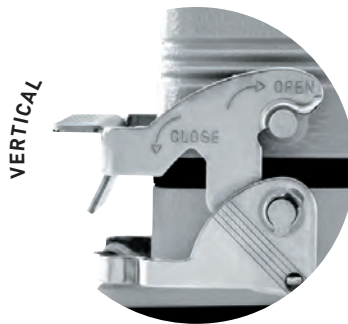


USED FOR ENCLOSURES:

- C-TYPE (IP65 or IP66)
- W-TYPE (IP65 or IP66)
for aggressive environments
- 180 °C (IP65) for high temperatures with a completely metallic lever
- EMC (IP65 or IP66) for electromagnetic compatibility
- INSULATED 830V (IP65 or IP66) for CME 830V inserts

V-TYPE

Vertical closing
up to IP67

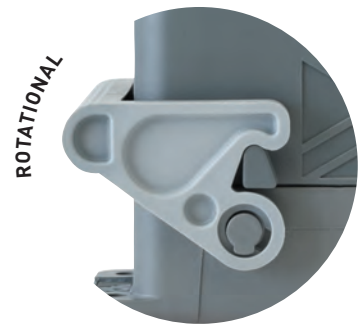


USED FOR ENCLOSURES:

- C7 (IP66/IP67) stainless steel levers
- CV (IP65 or IP66) stainless steel levers

T-TYPE

Thermoplastic lever



USED FOR ENCLOSURES:

- T-TYPE (IP65)
- T-TYPE/W (IP66/IP69)
- HYGIENIC: T-TYPE/H, T-TYPE/C (IP66/IP69)
- LS-TYPE (IP65)

IL-BRID

The coordinated effect
of two works

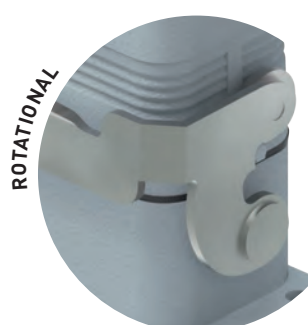


USED FOR ENCLOSURES:

- CZ - MZ IL-BRID (IP66)

CZ7 RIGID LEVER

Rigid locking lever
in stainless steel



USED FOR ENCLOSURES:

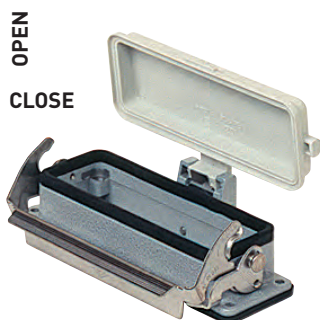
- CZ7 - MZ7 (IP67)

TYPE OF COVERS

2-POSITION OPEN/CLOSED, HINGED

WHITE THERMOPLASTIC

LP / CP

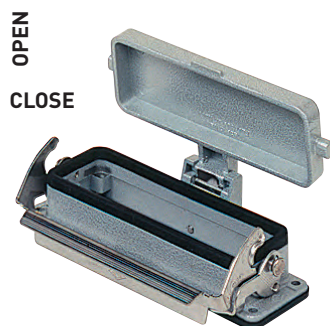


USED FOR ENCLOSURES:

- C-TYPE (housings with levers)
- CV (housings with lever)

METAL VERSION

LS / CS



USED FOR ENCLOSURES:

- C-TYPE (housings with levers)
- CV (housings with lever)

METAL VERSION

LS / CS



USED FOR ENCLOSURES:

- CZ7 housings with levers

SIMPLEX SELF-CLOSING, HINGED

BLACK THERMOPLASTIC

LSP



USED FOR ENCLOSURES:

- CV (housings with lever)

BLACK THERMOPLASTIC

LSP



USED FOR ENCLOSURES:

- CZ (housings with lever)

METAL VERSION

LS



USED FOR ENCLOSURES:

- CKA (housings with lever)

TYPE OF HOODS / HOUSINGS

C-TYPE



This series has been developed for application in electrical and electronic machinery, control units, electrical panels, control equipment, in industrial environments and in general, wherever a reliable and easily disconnectable connection is required for power and signal circuits.

Functional characteristics

- Wear of pins greatly reduced by the presence of rolls, that provide a smooth closure;
- resilience of double spring mechanism for automatic compensation of any coupling tolerance;
- the inserts of the CMCE series (except the 16+2 poles) and of the CMSH series may use standard enclosures also for uses of up to 830V.

- ✓ UL certified for USA and Canada for Type 4, 4X (outdoor use) and 12 (indoor use) degrees of protection (enclosure type rating), marked on the packaging.
IP65 or IP66/IP69 degrees of protection according to model.

Characteristics of materials for CH, CA and MH, MA, MF series

- Made of die cast aluminium alloy;
- with epoxy-polyester thermosetting powder coating;
- gaskets in anti-aging, oil-resistant, grease-resistant and fuel-resistant vinyl nitrile elastomer;
- locking device with levers, springs, rolls and pins in stainless steel;
- lever handles in self-extinguishing thermoplastic material reinforced with glass fibres, UL approved (for CH, CA and MH, MA enclosures);
- ambient temperature range: -40 °C / +125 °C.

V-TYPE IP67



This original design locking lever, due to the vertical closing movement, offers an IP66/IP67/IP69 degree of protection according to EN 60529 when fitted with a complete and coupled connector using ILME standard aluminium hoods (without adaptor) with die cast pegs.

Functional characteristics

- The friction on the pin is virtually zero as the locking lever exerts its pressure vertically, thus significantly reducing wear in case of frequent use;
- this locking lever can be used for applications with vibrations because it has no springs, hence resulting more rigid;
- this locking lever occupies a very small space during the closing phase;
- it is recommended in cases in which the weight of the cable tends to open elastic locking levers, like with vertically installed connectors and downwards cable exit;
- the absence of plastic parts provides better resistance in case of shocks and exposure to chemical contamination or risk of fire.

- ✓ UL certified for USA and Canada for Type 4, 4X (outdoor use) and 12 (indoor use) degrees of protection (enclosure type ratings), marked on the packaging.
IP66/IP67/IP69 degree of protection.

Characteristics of materials for C7, C7A and M7, M7A series

- Made of die cast aluminium alloy;
- with epoxy-polyester thermosetting powder coating;
- gaskets in anti-aging, oil-resistant, grease-resistant and fuel-resistant vinyl nitrile elastomer;
- locking device fully in stainless steel;
- ambient temperature range: -40 °C / +125 °C

T-TYPE AND T-TYPE/W



Alongside the wide range of traditional metallic enclosures for multipole connectors, ILME was a pioneer in offering a new series of enclosures in self-extinguishing thermoplastic material in the most common sizes of "44.27", "57.27", "77.27" and "104.27".

Functional characteristics

- Pre-fastened gaskets for easier installation;
- external dimensions of the bulkhead housing are similar to those of the corresponding metal enclosures and hole fixing centres are unchanged;
- ample space inside enclosures for cables, with mounted connectors, similar to the corresponding metal high construction versions;
- possibility of making completely insulated constructions (equivalent to Class II);
- absence of powder paint for environments in which these are not recommended;
- manufactured from insulating material, do not require special reinforced insulation as the metal versions do, for use with series CME 830V higher voltage connector inserts (screw-type terminals).

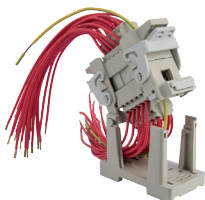
- ✓ UL Type 12 degree of protection (enclosure type rating) according to ANSI/UL 50E.
IP65 (T-TYPE standard),
IP66/IP69 (T-TYPE/W) degree of protection.

Characteristics of materials for T-TYPE and T-TYPE/W series

- Enclosures in thermoplastic material, dark grey RAL 7012 colour, with high thicknesses providing structural solidity and durability;
- **T-TYPE series: built-in polyurethane gaskets;**
- **T-TYPE/W series: built-in FKM fluoroelastomer sealing gaskets;**
- locking levers in thermoplastic material colour grey RAL 7001;
- M25, M32 and M40 threaded cable entries;
- each enclosure carries its own part number, thread/size, conformity markings and UL type rating;
- ambient temperature range: -40 °C / +90 °C.

T-TYPE/W series have been developed for industrial applications with particularly aggressive external agents (e.g. salt atmospheres or environments).

Q As the characterizing element of the T-TYPE/W series is the different sealing gasket material, hoods and covers without sealing gaskets for these series are the same of T-TYPE Standard.

COB

The COB system makes it possible to use multipole connectors within electrical panels without the traditional metallic enclosure, as environmental protection is assured by the electrical panel itself or other container.

Q Connectors must not be operated live.

Functional characteristics

- The system may be assembled on panels with window snap fastening device; on DIN EN 60715 rails, both lengthways and crossways to the support; on fixed panels using screws;
- reduction in cost and space with respect to metallic enclosures and traditional terminal boards;
- possibility of rewiring at the connector bench with connected devices;
- easy wiring inspection and tests with coupled connectors, thanks to rear access to the inserts via the turnover device;
- fast mounting in panels thanks to the snap fastening device on the DIN EN 60715 rails;
- sturdy support structure, specific to the size of each insert and does not require any preparation;
- broad passage for housing of conductor cables;
- mobile parts prearranged for the clamping of bundles of conductors of multipolar cables to prevent contact with the connector contacts

✓ IP20 degree of protection.

Characteristics of materials for COB system supports

- Self-extinguishing thermoplastic insulating materials, UL certified (COB supports, locking levers, hoods), compatible with the -40 °C / +125 °C operating temperature range of connector inserts;

IL-BRID

Through its original design, the IL-BRID locking lever combines the smoothness of the thermoplastic material with the sturdiness of the stainless steel spring; it has also a linear design which favours a quick wash without retaining external elements.

Functional characteristics

- **Soft closing:** in the first phase, the thermoplastic locking lever component comes into play: sliding the locking lever on the pin reduces friction and wear. It is suitable in all applications with frequent opening and closing.
- **Strong hold:** after the first closing phase involving the plastic component, the stainless steel hook intervenes to guarantee higher resistance to mechanical stress.

✓ IP65 degree of protection versions with hinged cover.

✓ IP66/IP69 degree of protection.

Characteristics of materials for CZ and MZ series

- Made of die cast aluminium alloy;
- with epoxy-polyester powder coating;
- gaskets in anti-aging, oil-resistant, grease-resistant and fuel-resistant vinyl nitrile elastomer;
- locking device with levers and springs in stainless steel;
- lever handles in self-extinguishing thermoplastic material reinforced with glass fibres, UL approved (for CZ and MZ enclosures)

C7/CZ7 IP67

Enclosures with rigid stainless steel lever to assure an IP66/IP67/IP69 dust and watertight seal.

Functional characteristics

- **C7 series: V-TYPE stainless steel locking lever, vertical closing**

- sizes 44.27, 57.27, 77.27, 104.27
- with and without hinged cover (except size 57.27)
- bulkhead or surface mounting
- recommended in case of vibrations or heavy weight of cables

- **CZ7 series: stainless steel locking lever, rigid**

- sizes 49.16, 66.16
- with and without hinged cover
- bulkhead or surface mounting
- recommended in case of vibrations or heavy weight of cables.

✓ IP66/IP69, IP66/IP67/IP69 degrees of protection according to model.

Characteristics of materials for C7, CZ7 series

- Made of die cast aluminium alloy;
- with epoxy-polyester thermosetting powder coating;
- gaskets in anti-aging, oil-resistant, grease-resistant and fuel-resistant vinyl nitrile elastomer;
- locking device integrally in stainless steel;
- ambient temperature range: -40 °C / +125 °C.

IP68



For applications in the railway sector and whenever the following characteristics are demanded: high pressure, impact and corrosion resistance, with degree of protection IP68. They also guarantee a good shielding for electromagnetic compatibility.

Functional characteristics

- The IP66/IP68/IP69 degree of protection is ensured if the enclosures are correctly installed and the cable entry devices have equal or higher rating.
- ✓ UL certified for USA and Canada for Type 4, 4X (outdoor use) and Type 12 (indoor use) ratings, marked on the packaging. IP69 degree of protection for tightness to pressurized water jets.

Characteristics of materials for CG and MG series

- Made of die cast aluminium alloy;
- with thermosetting epoxy powder coating;
- locking device with either screws or bayonets (types with suffix B).

180 °C



Series specifically developed for industrial applications where the ambient temperatures are particularly harsh (from -40 °C to +180 °C).

Functional characteristics

- For use with inserts in self-extinguishing thermoplastic material suitable for high temperatures (>PPS< polyphenylene sulphide);
- this version is distinguished by the red colour of the enclosures.
- ✓ UL certified for USA and Canada for Type 4, 4X (outdoor use) and Type 12 (indoor use) ratings, marked on the packaging. IP65/IP69 degree of protection.

Characteristics of materials for CK..R, CZ..R, CH..R, CA..R and MK..R, MZ..R, MH..R, MA..R series

- Made of die cast aluminium alloy;
- chromate treated die cast;
- coated with special thermosetting powder with high resistant to high temperatures;
- gaskets in anti-aging FKM fluoroelastomer;
- locking device with levers, springs and pins in stainless steel;
- single-block locking levers in stainless steel (for CZ..R, CH..R 48 and MZ..R, MH..R 48 versions);
- lever handles in die-cast aluminium with same special coating of enclosures (for CH..R 10, 16, 24 and MH..R 10, 16, 24 versions);
- supplementary insulation inside enclosures.

E-Xtreme®



ILME patented titanium plasma protection. Corrosion proof enclosures, resistant up to 3.000 hours in salt spray tests.

Functional characteristics

- Metal hoods and housings intended for extremely demanding environments, with special protective treatment under painting. Their special patented protective coating assures a high level of protection against the corrosion and erosion even in case of long-term exposure to salt mist;
- corrosion-proof aluminium with a special coating under the thermosetting powder coating colour RAL 7016 dark grey;
- FKM gasket (-40 °C...+180 °C) or silicone gasket (-60 °C...+180 °C);
- V-TYPE lever or C-TYPE lever, hoods with moulded pegs or riveted stainless steel bolts;
- durable protection against damage caused by stone chip, icing, salt mist, UV radiations and harsh gases
- ✓ IP65, IP66/IP69, IP66/IP67/IP69, IP66/IP68/IP69 (CG-MG) degrees of protection according to EN IEC 60529 (in mated and locked condition), according to model.

Characteristics of materials for E-Xtreme® series

- Material: aluminium die-cast
- Painting: thermosetting epoxy powder coating
- Colour: RAL 7016 (dark grey)
- Locking lever, springs and pegs: stainless steel
- Lever handle: C-Type polyamide; V-Type stainless steel
- Gasket: FKM
- Silicone-based compounds: free (except version for -60 °C... +180 °C)
- EN ISO 9227: 3.000 hours (V-Type lever and hood with moulded pegs); 2.000 hours (C-Type lever and hood with riveted stainless steel bolts)

BIG

The large dimensions of these innovative enclosures series have been chosen to offer customers an adequate space to store conductors.

✎ Functional characteristics

- The width of this enclosures is greater than that of previous versions: 66 mm compared to the 43 mm for standard enclosures.
- The height of BIG enclosures has also been increased to 100 mm for sizes "44.27" and "57.27" (standard versions for high models: 70 and 72 mm), and to 110 mm for sizes "77.27" and "104.27" (standard versions for high models: 76 mm).
- The cable compartment is now fully accessible during assembly (the connector insert is fully inserted in the lower half of the enclosure), offering three times the space compared to standard enclosures. This means it is possible to bend cables and pipes with greater bending radii.

✎ Due to this important feature, the BIG enclosures are particularly suitable for MIXO modular inserts, being versatile and customizable, for multiple cable entries. Each insert, differentiated according to electric power or signal, pneumatic, optical fibre or Ethernet network current, may thus have the specific branching. One single large connector can replace what previously required two connectors.

✔ IP66/IP69 degree of protection.

✎ Characteristics of materials for CB and MB series

- Made of die cast aluminium alloy;
- with epoxy-polyester thermosetting powder coating;
- die cast integral pegs.

EMC

This series has been developed for industrial applications that require electromagnetic compatibility (EMC, Electromagnetic Compatibility) in accordance with the European standards that regulate the emission and immunity of the equipment.

✎ Functional characteristics

- EMC enclosures maintain the robustness and reliability of standard types whilst possessing increased high frequency shielding characteristics.
- ✔ UL certified for USA and Canada for NEMA 4, NEMA 4X and NEMA 12 degrees of protection (enclosure type ratings) printed on the packaging. IP65/IP69 or IP66/IP69 degree of protection according to model.

✎ Characteristics of materials for CK..S and MK..S series

- Chromate coating treatment, RoHS 2 conform of die casts with high surface conductivity;
- special gaskets in highly conductive material;
- single-block locking lever in stainless steel.

for CZ..S, CH..S, CA..S and MZ..S, MH..S, MA..S series

- Made of die cast aluminium alloy;
- chromate conversion coating treatment of die cast, RoHS 2 conform, with high surface conductivity;
- special gaskets in highly conductive material;
- locking device with levers, springs and pins in stainless steel;
- lever handles in self-extinguishing thermoplastic material reinforced with glass fibres, UL approved.

W-TYPE

This series has been developed for industrial applications with particularly aggressive external agents (e.g. salt atmospheres or environments).

✎ Functional characteristics

- This version is distinguished by the black colour of the enclosures
- ✔ UL certified for USA and Canada for NEMA 4, NEMA 4X and NEMA 12 degrees of protection (enclosure type ratings) printed on the packaging. IP65/IP69 or IP66/IP69 degree of protection according to model.

✎ Characteristics of materials for CK..W and MK..W series

- Chromate treated die cast;
- with epoxy thermosetting powder coating;
- gaskets in anti-aging FKM fluoroelastomer;
- single-block locking device in stainless steel

CZ..W, CH..W, CA..W series and MZ..W, MH..W, MA..W series

- Made of die cast aluminium alloy;
- Chromate conversion coating, RoHS 2 conform treatment of die casts;
- with epoxy thermosetting powder coating;
- gaskets in anti-aging FKM fluoroelastomer;
- locking device with levers, springs and pins in stainless steel;
- pegs with stainless steel coating;
- single-block lever handles in stainless steel (for CZ...W and MZ...W enclosures);
- lever handles in self-extinguishing thermoplastic material reinforced with glass fibres, UL approved (CH..W, CA..W and MH..W, MA..W versions);
- supplementary insulation inside enclosures (for CZ...W and MZ...W enclosures)

HYGIENIC



The Hygienic multipole connector enclosures version (series T-TYPE/H and T-TYPE/C) has been designed for installation on food industry machines and systems.

Functional characteristics

- The following improvements to the T-TYPE series have been made in order to satisfy the requirements laid down by chapter 2.1 of Machinery Directive 2006/42/EC for the machines on which they are installed:
- material cleanliness and resistance to the cleaning and sanitising agents normally used in the food industry;
- materials in terms of the requirements for accidental contact with food products.

Q As the characterizing elements of the Hygienic Series are the different sealing gasket material and the different locking lever, hoods and covers without sealing gaskets and locking levers are the same of series T-TYPE Standard.

Characteristics of materials

for T-TYPE/H series

- Enclosures in thermoplastic material, dark grey RAL 7012 colour, with high thicknesses providing structural solidity and durability.
- Sealing gaskets made by HNBR rubber formulated in accordance with FDA Guideline 21 CFR §177.2600.
- Locking levers in metal detectable thermoplastic material, blue colour.
- M25, M32 and M40 threaded cable entries.
- IP66/IP69 degree of protection according to EN 60529.
- Each enclosure carries its own part number, thread/size and conformity markings.
- Ambient temperature range: -40 °C / +70 °C.

T-TYPE/C series

- The Hygienic T-TYPE/C Series enclosures have been specifically designed for food and beverage ambient temperature as low as -50 °C (range: -50 °C / +70 °C);
- enclosures in thermoplastic material, dark grey RAL 7012 colour, with high thicknesses providing structural solidity and durability;
- T-TYPE/C differs from T-TYPE/H for the sealing gaskets made by in accordance with FDA Guideline 21 CFR §177.2600;
- ILME T-TYPE/C series enclosure materials have been selected according to EU n. 10/2011 regulation requirements and each component has been tested according to EU regulation n. 10/2011 and EC regulation n. 1935/2004.
- IP66/IP69 degree of protection according to EN 60529.

LS-TYPE



Series specifically developed for applications like event and stage technology.

Functional characteristics

- These enclosures can be installed beside stages. They do not have any bright components that would distract and simple plastic levers that are easy to replace.
- ✓ UL certified for USA and Canada for NEMA 4, NEMA 4X and NEMA 12 degrees of protection (enclosure type ratings) printed on the packaging. IP65/IP69 degree of protection.

Characteristics of materials

for CH..N -MA..N and MH..N - MF..N LS-TYPE series

- Made of die cast aluminium alloy;
- powder-coated with RAL 9005;
- gaskets in anti-aging, oil resistant, grease resistant and fuel resistant vinyl nitrile elastomer;
- locking device with levers in black made of plastic;
- ambient temperature range -40 °C / +125 °C.

HNM



Connector enclosures designed to endure high number of matings, to be used in combination with HNM connector inserts and relevant HNM removable crimp contacts, extending the guaranteed number of matings up to 10 000.

Functional characteristics

- HNM Housing (bulkhead or surface mounting) equipped with ILME proprietary design V-Type locking lever, further improved with special treatment to reduce the wear due to friction at minimum.
- HNM Hoods equipped with riveted rolling pegs and special anti-friction lubrication treatment.
- Ensuring long life span in those applications where frequent connections and disconnections are expected exceeding the standard 500 mating cycles.

Characteristics of materials

for RV, RH, RF, RAC HNM series

- Made of die cast aluminium alloy;
- coated with thermosetting powder coating, epoxy-polyester;
- gaskets in anti-aging, oil resistant, grease resistant and fuel resistant vinyl nitrile elastomer;
- V-Type single locking lever, stainless steel;
- ambient temperature range -40 °C / +125 °C

CENTRAL LEVER



Series specifically designed for industrial applications with limited installation space.

Functional characteristics

- These enclosures can be installed, placed side-by-side and handled in a single operation. Furthermore, the lever's shape reduces the effort required to uncouple the inner fittings.

✓ IP65 degree of protection.

Characteristics of materials

for CH..YC, CA..YC and MA..YC, CA..YX and MF..YX series

- Made of die cast aluminium alloy;
- with epoxy-polyester thermosetting powder coating;
- gaskets in anti-aging, oil-resistant, grease-resistant and fuel-resistant NBR vinyl nitrile elastomer;
- locking device with single stainless steel lever;
- stainless steel locking pegs with rollers, to reduce wear.

MIXO ONE



MIXO ONE is the aluminium housings system designed by ILME to accept the wide range of MIXO series single-sized modules.

Functional characteristics

- These robust connector enclosures (3 hood variants and 1 bulkhead mounting housing) transform each single MIXO module into a completely independent connector;
- the enclosures allow mounting of single MIXO module only in one guided way, to avoid incorrect match with the mating connector;
- the enclosures incorporate a pre-leading (first-make, last-break) PE connection terminal and contact, for the safest connector operation;
- the pins protruding from the bulkhead mounting housing act also as key guide, in cooperation with the corresponding keyway sockets in the hoods, to avoid incorrect 180° reversed mating with corresponding connector;
- the rigid locking lever is releasably mounted on moulded pegs that include stopping teeth;
- the hoods are split in two parts (front, rear), to allow MIXO module mounting and simplify the enclosure's PE connection. Supplied with four self-threading screws and self-retaining sealing gasket;
- the bulkhead mounting housing is supplied with the module locking frame and self-retaining flange gasket;
- four optional coding pins available;
- protection covers for hoods and housings available.

✓ cURus Type 4/4X/12 pending
IP65 degree of protection

Characteristics of materials

for CXA 01..., MXA 01... series

- Die cast aluminium alloy, nickel plated;
- gaskets in anti-aging, oil resistant, grease resistant and fuel resistant NBR vinyl nitrile elastomer;
- locking device with stainless steel single lever;
- module locking frame in stainless steel;
- self-threading assembly screws in stainless steel;
- optional coding pins CR CX... in self-extinguishing thermoplastic insulating material (UL 94V-0).

For CXP 01... covers

- Shock-proof self-extinguishing thermoplastic material (UL 94 V-0) suitable for outdoor exposure, either with pegs (for enclosures with locking lever and sealing gasket) or with locking lever and sealing gasket (for enclosures with pegs) both with eyelet-terminated string (for fastening to housings) or with loop-terminated cord (for fastening to hoods, around the incoming cable);
- locking device – if any – made by the same material of the cover.

CK - MK - CKA - MKA CQ - MQ



Thermoplastic and metallic enclosures size "21.21" for standard or aggressive environments and insulated version size "32.13"

Functional characteristics

- For use with all size "21.21" connector inserts;
- Thanks to the inner coding key differently shaped between metallic enclosures (trapezoidal cross-section) and insulating enclosures (rectangular cross-section inscribed in the trapeze), connector inserts size "21.21" having a floating PE contact (e.g. CDF/M 07) while for use at voltages higher than SELV (safety extra-low voltage) are prevented to fit into metallic enclosures CKA-MKA, CGK-MGK, as they would not provide the required PE connection to the enclosure. The corresponding outer coding keyway of all "21.21" inserts having the PE contact able to guarantee bonding to earth to the metallic enclosure or of those inserts deemed to be used only at SELV is similarly trapezoidal, thus these inserts fit into all enclosures. Insulating "21.21" enclosures accept all "21.21" inserts.
- CGK-MGK IP68 enclosures (currently IP66/IP68/IP69) available both with 2-screw locking or by 2-bayonet locking (types with suffix B).

✓ UL certified for USA and Canada for Type 4, 4X and 12 degrees of protection (enclosure type ratings, equivalent to NEMA rating), printed on the packaging.
IP44 degree of protection, IP66/IP67/IP69 by using the special fixing screw + gasket kit CKR 65(D) separately available, and suitable cable outlet device.
IP66/IP68/IP69 degree of protection for CGK-MGK enclosures equipped with **CKR 65(D)** kit.

Characteristics of materials

for CK, MK and CQ series

- In self-extinguishing light grey RAL 7035 or jet black RAL 9005 thermoplastic material for insulating (CQ series only available black) or metallic enclosures;
- metal enclosures in die cast zinc or aluminium alloy, according to model;
- metal enclosures with epoxy-polyester thermosetting powder coating;
- gaskets in anti-aging, oil-resistant, grease-resistant and fuel-resistant NBR vinyl nitrile elastomer;
- metallic enclosures with single-block locking lever in stainless or galvanized steel;
- insulating enclosures with single-block locking lever in self-extinguishing thermoplastic material.

ENCLOSURES FEATURES


Series	Version	Material	Size	Size ID	Cable entry		Locking device
CK / MK	Standard	Insulating	21.21	03	M20 - M25	Pg 11	single
CKX							
CKA / MKA	Standard W (Aggressive environments) S (EMC) E (E-Xtreme®)	Metallic	21.21	03	M20 - M25	Pg 11	single
CKAX / MKAX							
CKAXX / MKAXX							
CKG / MKG	Standard	Insulating	21.21	03	M20 - M25	Pg 11	single
CKAG / MKAG		Metallic					
IP68 (CGK / MGK)	IP68	Metallic	21.21	03	M20 - M25	Pg 13,5	dual screw / bayonet
CQ / MQ	Standard	Insulating	32.13	08	M25x2	Pg 16 - Pg 21	single
	S (EMC)	Insulating metallized					
MIXO ONE (CXA, MXA)	EMC as standard	Metallic	—	—	M25 - M32	—	single
IL-BRID (CZ / MZ)	Standard	Metallic	49.16	15	M20 - M25	Pg 13,5 - Pg 21	single
			66.16	25			
			49.16	15			
CZ7 / MZ7	Standard W (Aggressive environments) S (EMC) R (High temperatures) E (E-Xtreme®)	Metallic	66.16	25	M20 - M25	Pg 16 - Pg 21	single
			49.16	15			
			66.16	25			
C-TYPE (CH / CA / MH / MA)	Standard C-TYPE W (Aggressive environments) S (EMC) R (High temperatures) 830V (Insulated) E (E-Xtreme®)	Metallic	66.40	50	M25 - M40	Pg 21 - Pg 29	dual
			44.27	06	M20 - M40	Pg 13,5 - Pg 29	single
			57.27	10		Pg 16 - Pg 29	dual
			77.27	16	M25 - M50	Pg 21 - Pg 36	
			104.27	24			
			77.62	32	M32 - M50	Pg 29 - Pg 42	single / dual
			104.62	48			single

**CM/MM enclosures for 830V screw type connector inserts CME series available only upon request
(as well as the CME series inserts)**


- Enclosures ensure IP degree of protection when coupled and locked with the locking lever. The cover (CS, CP) only provides mechanical protection without ensuring the IP degree of protection.
- .. LP versions with plastic cover have not the UL approval.
- Approved by CQC in combination with relevant CQC certified connector inserts as accessories that provide the declared IP degree of protection, their part. Nos. not showing up in the CQC Certificates.

Series	IP (EN 60529) ¹⁾	UL 50 Type (NEMA 250 type)	Certifications	Notes	Ambient temperature limit (°C)		From page	
CK / MK	IP44 IP66/IP67/IP69 *	12 4 *, 4X *	cUR _{US} , CQC ³⁾ DNV-GL, BV, ESTD	* with CKR 65 (D)	-40	+125	339	
CKX							cUR _{US} , CQC ³⁾	344
CKA / MKA	IP44 IP66/IP67/IP69 *	12 4 *, 4X *	cUR _{US} , CQC ³⁾ DNV-GL, BV, ESTD	* with CKR 65 (D)	-40	+125	349	
CKAX / MKAX							cUR _{US} , CQC ³⁾ , DNV-GL, BV	350
CKAXX / MKAXX							cUR _{US} , CQC ³⁾	
CKG / MKG	IP66/IP67/IP69	12, 4, 4X	cUR _{US} , CQC ³⁾ DNV-GL, BV, ESTD	for DESINA® compliant connectors	-40	+125	347	
CKAG / MKAG							353	
IP68 (CGK / MGK)	IP66/IP68/IP69	12, 4, 4X	cUR _{US} , CQC ³⁾ DNV-GL, ESTD		-40	+125	628	
CQ / MQ	IP66/IP67/IP69	12, 4, 4X	cUR _{US} , CQC ³⁾ DNV-GL, BV, ESTD	with conductive gasket CR 08 EMC	-40	+125	366, 573	
MIXO ONE (CXA, MXA)	IP65	12, 4, 4X	cUR _{US} , CQC ³⁾	for single size MIXO modules	-40	+125	369	
IL-BRID (CZ / MZ)	IP66/IP69	12, 4, 4X	cUR _{US} , CQC ³⁾ DNV-GL, BV, ESTD	with hinged cover when not mated and locked with lever when mated and locked with the closing lever	-40 R = -40	+125 R = +180	374	
	IP65						374, 378	
	IP44 (SIMPLEX) IP65 (SIMPLEX)						375, 379	
CZ7 / MZ7	IP66/IP67/IP69		cUR _{US} , CQC ³⁾ DNV-GL, BV, ESTD	enclosures ensure IP67 degree of protection when coupled with hoods or covers with moulded pegs			384, 385 519, 520 576, 577 586 540, 541	
C-TYPE (CH / CA / MH / MA)	IP44 IP66/IP69 IP65	12 12, 4, 4X ²⁾ 12, 4, 4X ²⁾	cUR _{US} , CQC ³⁾ DNV-GL, BV, ESTD		-40 R = -40	+125 R = +180	387	

ENCLOSURES FEATURES

Series	Version	Material	Size	Size ID	Cable entry		Locking device	
T-TYPE (TCH / TH / TMA / TA)	Standard (RAL 7012 grey) W (Aggressive environments) HYGIENIC (H) HYGIENIC (C)	Insulating	44.27	06	M25 - 32	—	single	
			57.27	10			dual	
			77.27	16	M32 - 40			
			104.27	24				
V-TYPE IP67 (C7I, C7P / M7P, ...)	IP67 stainless steel levers E (E-Xtreme®)	Metallic	44.27	06	M20 - 40	Pg 16 - 29	single	
			57.27	10			dual	
			77.27	16	M25 - 40			
			104.27	24				
V-TYPE (CVI L, CVP / MVP L, ...)	IP65/IP66 stainless steel levers	Metallic	44.27	06	M20 - 40	Pg 16 - 29	single	
			57.27	10				
			77.27	16	M25 - 40			Pg 21 - 29
			104.27	24				
BIG (CB / MB)	Standard W (Aggressive environments) E (E-Xtreme®)	Metallic	44.27	06	M20 - 50	—	single	
			57.27	10			dual	
			77.27	16				
			104.27	24				
IP68 (CG / MG)	Standard (inherently EMC) E (E-Xtreme®)	Metallic	44.27	06	M25 - 32	Pg 16 - 29	screw / bayonet	
			57.27	10				
			77.27	16	M32 - 50			Pg 21 - 29
			104.27	24				
Central lever (...YX / ...YC)	Standard	Metallic	44.27	06	M25 - 32	Pg 16 - 29	single central lever	
			57.27	10				
			77.27	16	M32 - 40			Pg 21 - 29
			104.27	24				
COB	Standard	Insulating	44.27	06	—	—	dual	
			57.27	10				
			77.27	16 				
			104.27	24				
LS-TYPE (CHIN, CHPN / MHPN, ...)	Light and sound applications (Black colour)	Metallic Thermoplastic lever	44.27	06	M20 - 40	Pg 16 - 29	single	
			57.27	10			dual	
			77.27	16	M25 - 40		Pg 21 - 29	
			104.27	24				

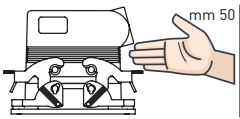

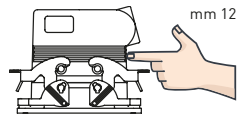
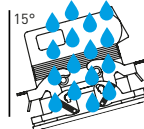
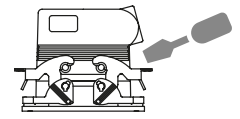
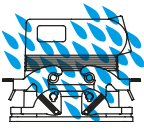
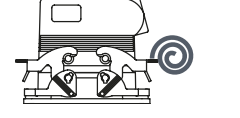
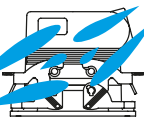
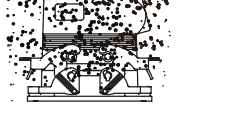
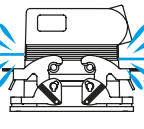
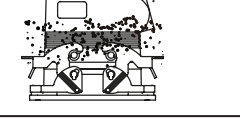
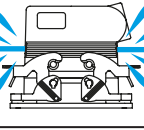
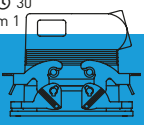
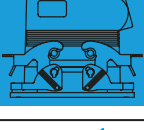
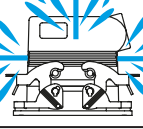
CM/MM enclosures for 830V screw type connector inserts CME series available only upon request (as well as the CME series inserts)

- 1) Enclosures ensure IP degree of protection when coupled and locked with the locking lever. The cover (CS, CP) only provides mechanical protection without ensuring the IP degree of protection.
 - 2) .. LP versions with plastic cover have not the UL approval.
 - 3) Approved by CQC in combination with relevant CQC certified connector inserts as accessories that provide the declared IP degree of protection, their part. Nos. not showing up in the CQC Certificates.
-  49.16 (15) and 66.15 (25) with adapter CR xx/16.

Series	IP (EN 60529) ¹⁾	UL 50 Type (NEMA 250 type)	Certifications	Notes	Ambient temperature limit (°C)		From page
T-TYPE (TCH / TH / TMA / TA)	STD - IP65 W - IP66/IP69 T-TYPE/H - IP66/IP69 T-TYPE/C - IP66/IP69	12	cUR _{US} , CQC ³⁾ DNV-GL, BV, ESTD		STD -40 W -40 T-TYPE/H -40 T-TYPE/C -50	STD +90 W +90 T-TYPE/H +70 T-TYPE/C +70	480
V-TYPE IP67 (C7I, C7P / M7P, ...)	IP66/IP67/IP69	12, 4, 4X ²⁾	cUR _{US} , CQC ³⁾ DNV-GL, BV, ESTD		-40	+125	436
V-TYPE (CVI L, CVP / MVP L, ...)	IP65 IP66/IP69	12, 4, 4X ²⁾	cUR _{US} , CQC ³⁾ DNV-GL, BV, ESTD	SIMPLEX with self-closing cover	-40	+125	444
BIG (CB / MB)	IP66/IP69	12, 4, 4X	cUR _{US} , CQC ³⁾ DNV-GL, BV, ESTD		-40	+125	466
IP68 (CG / MG)	IP66/IP68/IP69	12, 4, 4X	cUR _{US} , CQC ³⁾ DNV-GL, BV, ESTD		-40	+125	632
Central lever (...YX / ...YC)	IP65	12, 4, 4X	cUR _{US} , CQC ³⁾ DNV-GL, BV, ESTD		-40	+125	603
COB	IP20		cUR _{US} , CQC ³⁾ DNV-GL, BV, ESTD		-40	+125	652
LS-TYPE (CHIN, CHPN / MHPN, ...)	IP65	12, 4, 4X ²⁾	cUR _{US} , CQC ³⁾ DNV-GL, BV, ESTD		-40	+125	618

THE DEGREE OF PROTECTION

The connector's housing, sealing and locking mechanism protect the connection from external influences such as mechanical shocks, foreign bodies, humidity, dust, water or other fluids such as cleansing and cooling agents, oils, etc. The degree of protection the housing offers is explained in the IEC 60529, DIN EN 60529, standards that categorize enclosures according to foreign body and water protection. The following table shows the **IP (Ingress Protection) Ratings Guide**.

FIRST Index figure	Degree of protection SOLIDS		SECOND Index figure	Degree of protection WATER	
0		No protection	0		No protection
1		Protected against access to hazardous parts with the back of a hand and protected against solid foreign objects of Ø 50 mm and greater	1		Protected against vertically falling water drops
2		Protected against access to hazardous parts with a finger - protected against solid foreign objects of Ø 12,5 mm and greater	2		Protected against vertically falling water drops when enclosure tilted up to 15° (on either side of the vertical)
3		Protected against access to hazardous parts with a tool - protected against solid foreign objects of Ø 2,5 mm and greater	3		Protected against spraying water (at an angle up to 60° on either side of the vertical)
4		Protected against access to hazardous parts with a wire - protected against solid foreign objects of Ø 1,0 mm and greater	4		Protected against splashing water from any direction
5		Protected against access to hazardous parts with a wire dust-protected (no harmful dust deposit)	5		Protected against water jets from any direction
6		Protected against access to hazardous parts with a wire dust-tight (total protection against dust)	6		Protected against powerful water jets from any direction (similar to sea waves)
			7		Protected against the effects of temporary immersion in water at a maximum depth of 1 metre for 30 min
			8		Protected against the effects of continuous immersion in water at depth and/or duration upon agreement, more severe than for numeral 7
			9		Protected against high pressure and temperature water jets from any direction

RATING EXAMPLE

IP 6 5

Description according to IEC 60529

CHANGEOVER FROM PG THREADS TO METRIC

After 31st December 1999, the German safety standard DIN VDE 0619 (1987-09) and the standards it refers to - DIN 46319 for dimensions with metric threads and DIN 46320 (T1-T4), DIN 46255 and DIN 46259 for dimensions with Pg threads (Pg = Panzerrohr-Gewinde: literally "threads for armoured pipes") - were withdrawn and European standard EN 50262 "Metric cable glands for electrical installations" has been in force since 1st January 2000.

This standard defines the new sizes with metric threads for cable glands according to EN 60423 and establishes the safety prescriptions.

Conversely, it does not specify the dimensions, such as the size of the tightening wrench, the diagonal dimension, or the dimensions of the tightness seals, as was the case in the withdrawn DIN for Pg cable glands.

The standard came definitively into force on 1st April 2001, when the contrasting national standards were withdrawn.

It is valid in all member countries of CENELEC (European Electrical Standardisation Committee) and its publication has led to a broadening of the supply of enclosures for multi-pole connectors for industrial use, to include new enclosure versions with cable entry suitable for metric cable glands.

NOTE – In 2016 the new EN 62444:2013 standard "Cable glands for electrical installations" replaced the former to cover only cable gland with metric thread whose range is now M6 through M110 (previously up to M75).

Cable gland producers have introduced the new metric series to add to the Pg size series, to gradually replace the latter type. The transitional period indicated in the new standard should have ended on 1st March 2001, after which date the use of cable entry devices with Pg thread and, as a result, enclosures with Pg thread, should have ended in new installations. Nevertheless, both the cable entry devices and the relevant enclosures with Pg thread, may continue to be used as spare parts. For the mandatory **CE** marking of these items, observance of the safety conditions specified by the Low Voltage Directive is sufficient, however adherence to the safety requirements of EN 62444 provides presumption of conformity.

To distinguish hoods and surface-mounting housings with metric entries from the relevant Pg versions (identified with a C pre-code), the ILME metric types are identified with an M pre-code. The transposition table below indicates the correspondence rule adopted in most cases by ILME for creating the new metric versions.

Pg → metric transposition table

Pg	Metric
Pg 11	M20
Pg 13.5	M20
Pg 16	M20
Pg 21	M25
Pg 29	M32
Pg 36	M40
Pg 42	M50

Cable diameter for use with ILME cable glands

Ø in mm	Metric thread				
	20	25	32	40	50
AS M..P	6 - 12,5	10 - 18	14 - 24	15 - 24	23 - 30
AS M..E	8 - 12,5	13,5 - 18	17 - 24	—	—
AG M..T	6 - 8 -10	11 - 14 - 17	19 - 21 -24	26 - 29 - 32	35 - 38 - 41
AG M..I	5 - 12,5	9 - 18	14 - 25	18 - 32	24 - 38,5
AG M..R	6 - 8 -10	11 - 14 - 17	19 - 21 - 24	—	—

For more information, please refer to the technical catalogue on www.ilme.com

COMBINATIONS BETWEEN ENCLOSURES AND INSERTS

Identification of enclosures

Connector inserts and their enclosures are numerous and therefore the search for the correct pairing of one with another may be complex.


To facilitate this operation (in addition to the normal part number) the definition of “**size**” has been introduced in this catalogue.

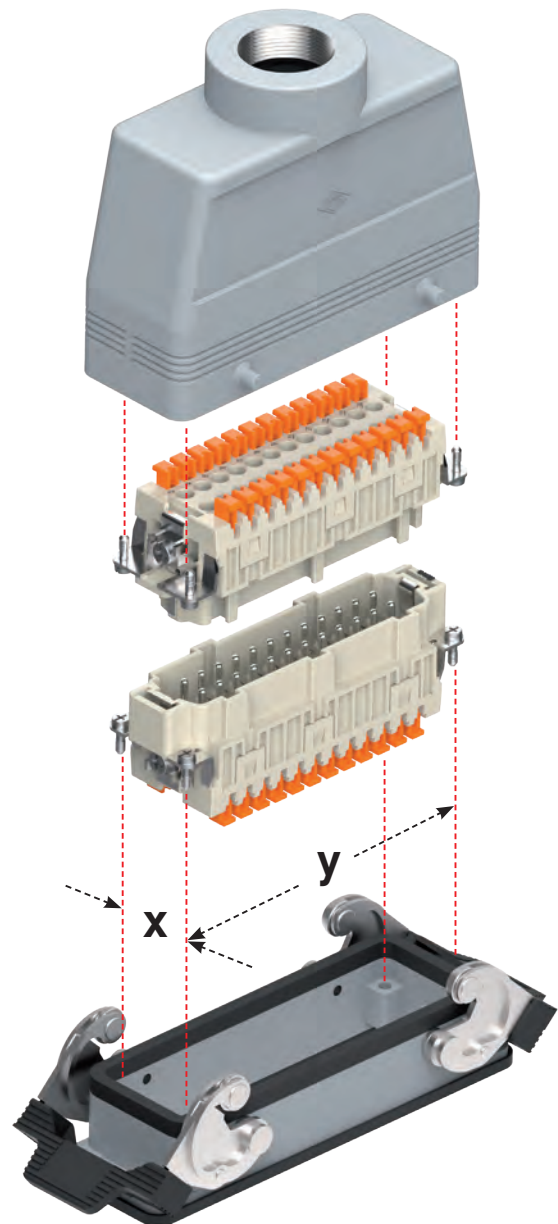
As indicated in the illustration on the left and in the table below, the size value refers to the “**x - y**” **fixing screw centre distance** which constitute a unique and shared element, since they are common to both the inserts and the enclosures.

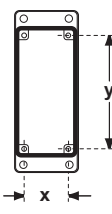
The following table shows all the sizes of the enclosures and the dimensions of the housings where the inserts will be fastened.

Enclosures size	Insert housing with x - y fixing screw centre distance
21.21	(21 x 21 mm) **
32.13	32 x 13 mm
49.16	49,5 x 16 mm
66.16	66 x 16 mm
66.40	66 x 16 mm (2 inserts)
44.27	44 x 27 mm
57.27	57 x 27 mm
77.27	77,5 x 27 mm
104.27	104 x 27 mm
77.62	77,5 x 27 mm (2 inserts)
104.62	104 x 27 mm (2 inserts)

** Dimensions relating to the insert cross-section size, not being able to identify a fixing screw centre distance, since all “21.21” sized inserts are provided with a single fixing screw.

 All pages that illustrate combinable articles (inserts and enclosures) carry references as per the examples illustrated on the opposite page.



Enclosures size x • y 	Rated current																		
	6A	10A	10A	10A	10A	10A	16A	16A	16A	16A	16A	16A	16A	35A	40A 16A 10A 6,5A	16A 10A	100A 40A 10A	80A 16A	200A 100A 70A 40A 16A 10A 5A 4A
	Inserts Series																		
	CDSH NC	CK - CKS ▲ CKSH	CD - RD (HNM)	CT - CTS	CDD - RDD (HNM)	CDS ▲ CDSH	CDA - CDC - CSAH	CCE - RCE (HNM)	CNE	CSE ▲ CSS - CSH	CT - CTS - CTSE	CME ▲	CMSE ▲ CMSH - CMCE	CP	CQ - COE - COEE RQEE (HNM)	CX	CX	CX	CX
Inserts polarity + ⊕																			
21.21		3 4	7 8 ⌘												2 3 5 7 12 21				
32.13															4/2 8 17				
49.16			15			10													1*
66.16			25		38	16													
66.40			50		76	32													
44.27	6				24 (HNM)	9		6 (HNM)	6	6	6 ■				10				2*
55.27					42 (HNM)	18		10 (HNM)	10	10	10 ■	3 ⁺²	3 ⁺²		18	8/24			3*
77.27			40 (HNM)	40 ■	72 (HNM)	27		16 (HNM)	16	16	16 ■	6 ⁺²	6 ⁺²	6	32 40 (HNM)		6/12 6/36 12/2	4/0 4/2	4*
104.27			64 (HNM)	64 ■	108 (HNM)	42		24 (HNM)	24	24	24 ■	10 ⁺² 16 ⁺² •	10 ⁺²		46 64 (HNM)		6/6	4/8	6*
77.62			80		144	54		32	32	32	32 ■	12 ⁺⁴	12 ⁺⁴	12	64				8*
104.62			128		216	84		48	48	48	48 ■	20 ⁺⁴ 32 ⁺⁴ •	20 ⁺⁴ 32 ⁺⁴		92				12*

Legend

- ⌘ Polarity without earth ⊕ contact.
- Can only be mounted in bulkhead housings (6/10/16/24 polarity, also usable with BIG series hoods).
- Polarity not available in CMSH version.
- * Number of modular inserts that may be inserted in the enclosures.

Polarity values in **LIGHT GREY background** are obtained using double inserts.

Polarity values in **LIGHT BLUE background** must be mounted exclusively in insulated enclosures (CM - CMA and MM - MMA versions) or T-TYPE series.

Polarity values indicated as exponentials in the CME, CMSH - CMCE inserts identify the pilot contacts for advanced opening.

▲ Available upon request

ACCESSORIES AND TOOLS FOR INSERTS AND ENCLOSURES

SUPPORTS AND ADAPTORS

Provide the solution to the most various installation needs. The extensive range of articles comprises: panel supports for inserts, special enclosures (housing with double outlet, wide housings, housings without outlets, to be punched out, housings for round cables, hoods), insert combination blocks, accessories for CT inserts, interface for printed circuits, kits for control equipment, plates for mounting D-Sub inserts onto enclosures, reducing plates and closure plates, protection lid for transportation, coding pins.

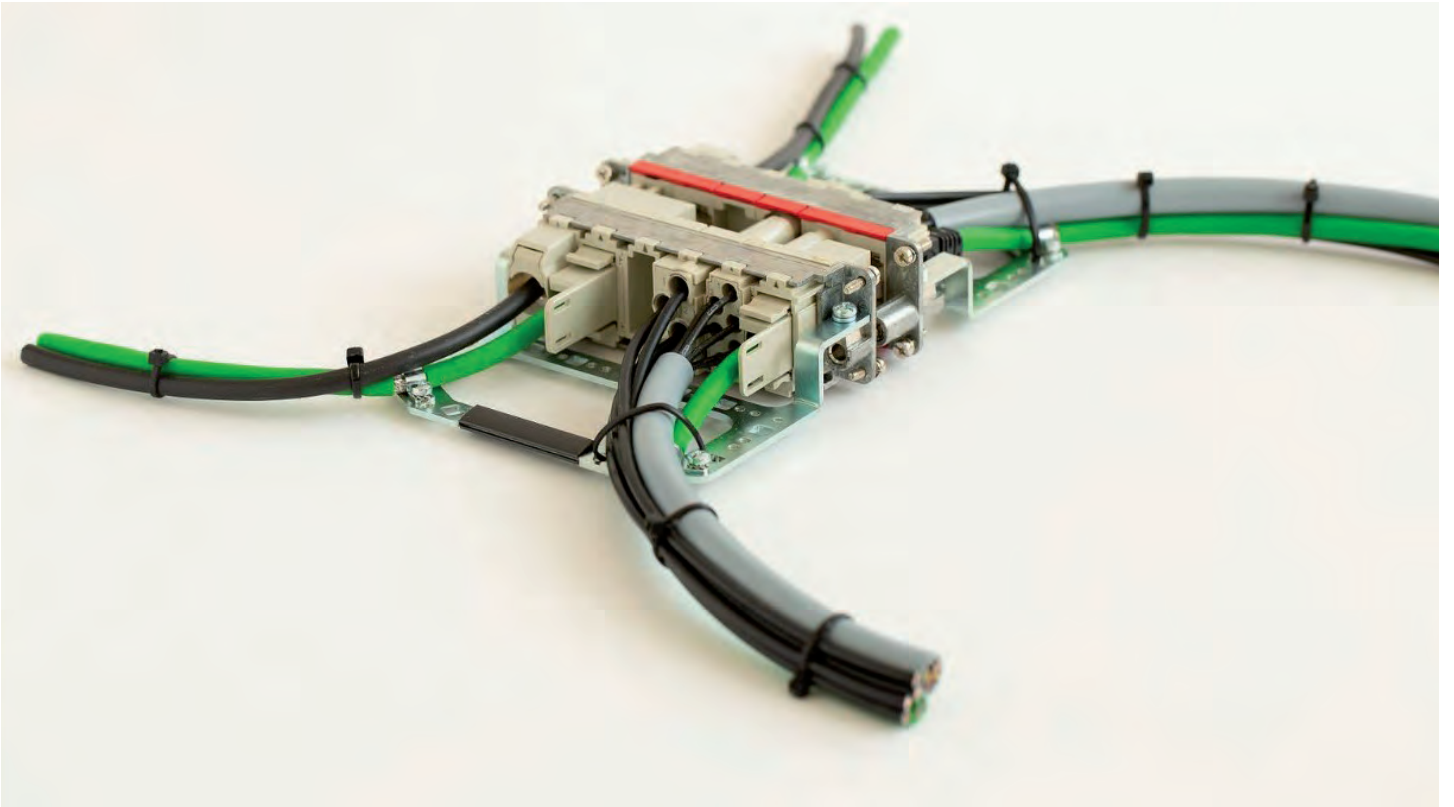


TOOLS

To guarantee the efficiency and safety of the connections a complete series of specific tools are available for contact crimping that assure the maximum quality required by the standards.

Manual or pneumatic or electric (battery operated) semi-automatic tools for light production or automatic electro-pneumatic tools for large-scale production are available, together with a complete series of complimentary tools for mounting and dismounting of the crimped contacts.





INSERTS



CK - CKD - CK...RY - CKSH-SQUICH®

- Screw terminal
10A - 230/400V
- Without tools (SQUICH®)
10A - 400V

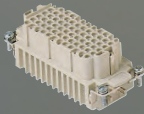
From page..... 58



CD

- Crimp
10A - 250V
- Crimp (CD 8 poles)
10A - 50V ac/120V dc

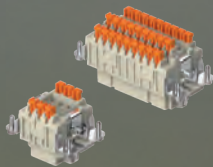
From page..... 66



CDD

- Crimp
10A - 250V

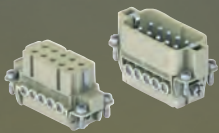
From page..... 76



CDSH-SQUICH® - CDSH NC-SQUICH®

- Without tools
10A - 400V
6A - 250V

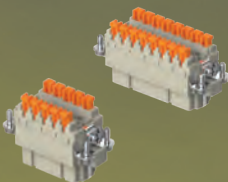
From page..... 86



CDA

- Screw terminal
16A - 250V

From page..... 98



CSAH-SQUICH®

- Without tools
16A - 250V

From page..... 99

**CDC**

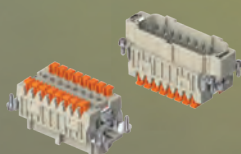
- Crimp
16A - 250V

From page..... 104

**CNE - CNE...RY**

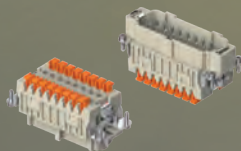
- Screw terminal
16A - 500V

From page..... 110, 116

**CSH-SQUICH®**

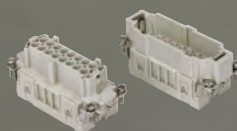
- Without tools
16A - 500V

From page..... 110

**CSH S-SQUICH®**

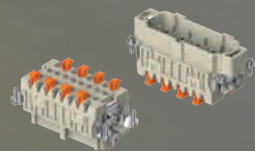
- Without tools
16A - 500V

From page..... 122

**CCE**

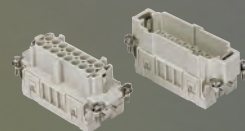
- Crimp
16A - 500V

From page..... 130

**CMSH-SQUICH®**

- Without tools (SQUICH®)
16A - 830V

From page..... 136

**CMCE**

- Crimp
16A - 830V

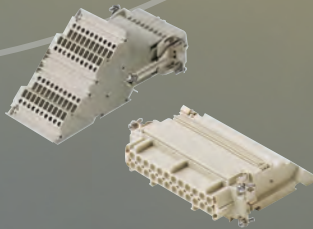
From page..... 137



CSS

- Dual spring
16A - 500V

From page..... 148



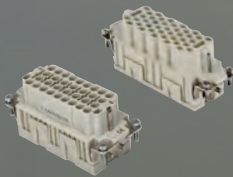
CT - CTS - CTSE

- Screw terminal
10A - 250V
16A - 400V

From page..... 156, 160

- Spring
10A - 250V
16A - 500V

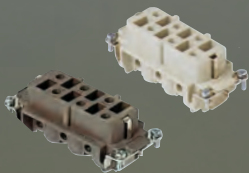
From page..... 156, 160



CQE - CQEE

- Crimp
16A - 500V

From page..... 168, 176



CP - CP...RY

- Screw terminal
35A - 400/690V

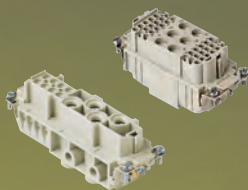
From page..... 178



CQ4 - CQ

- Crimp
6,5A/10A/16A/40A

From page..... 180



CX COMBINED INSERTS

- Crimp
10A/16A/40A/100A

From page..... 194

- Screw terminal
16A/80A

From page..... 200



HNM

- RD - RDD
Crimp
10A - 250V

From page..... 208



- RCE - RQEE
Crimp
16A - 500V

From page..... 214



- RX
Crimp
12 poles (40A-690V) + 2 poles (10A-250V + PE)

From page..... 221



DATA CONNECTORS

From page..... 222



DESINA®

From page..... 244



CK series with optional coding pins: avoid incorrect connections

The renewed CK series of inserts addresses the need for connector coding with the addition of coding pins CR K03, CR K04R and CR K04G.

Each connector is made to make coupling of inserts from different series impossible, by suitable key and key way. Inserts are also polarized against inadvertent 180° mating. When a number of identical connectors with different functions are mounted close together, the coupling of a free part onto a non-corresponding fixed part must be prevented in order to avoid possible damage and breakdown.

The coding pins added to the renewed CK series **allow the user to safely configure the male and female inserts** to prevent the incorrect connection of identical connectors.

With various combinations of coding pins available, it is possible to safely install up to 4 connectors of the same type but with different functions side-by-side.



SUM UP

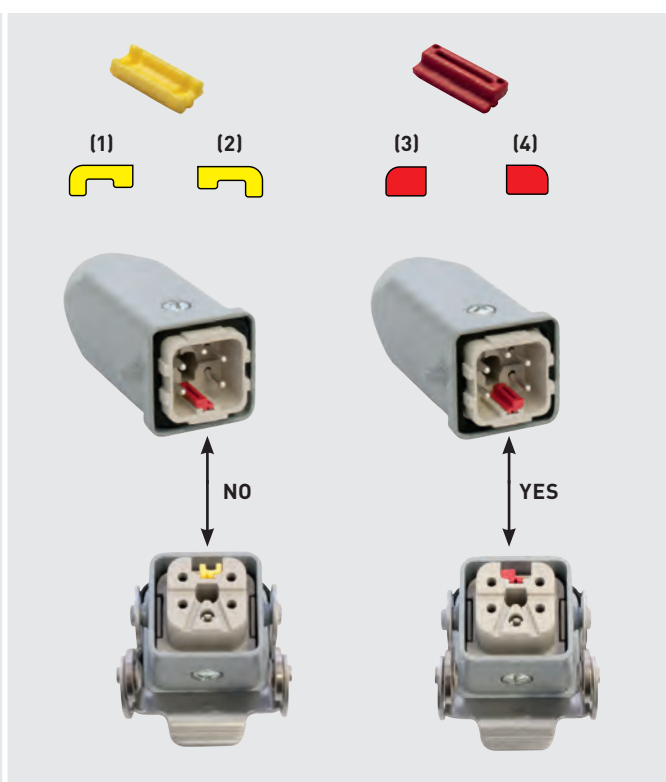
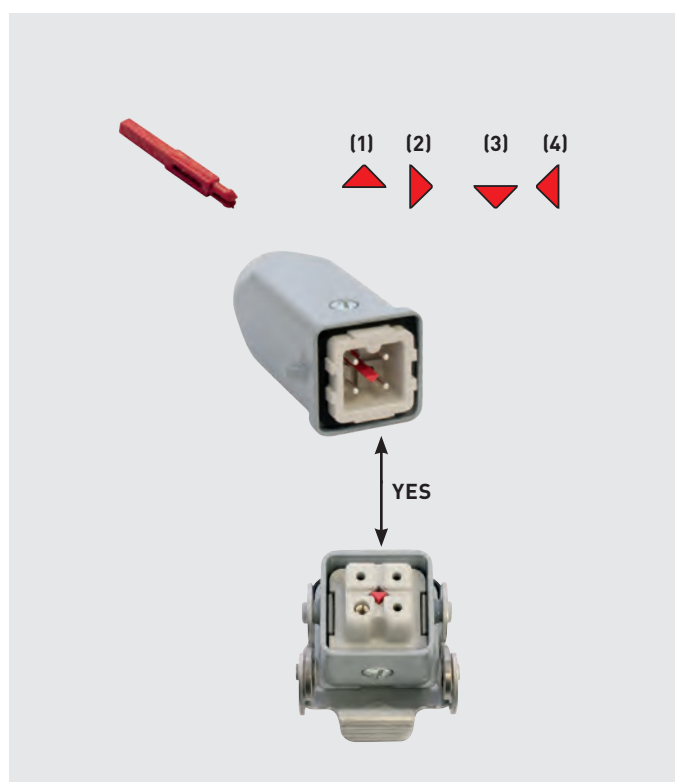
- ☑ Connection up to 2,5 mm²
- ☑ New RAL 7032 colour
- ☑ Bult-in silver or gold plated contacts

CR K03 version, for connectors 3P + ⊕

Inserting the pin in the 4 possible positions by rotating through 90° allows 4 different insert codings to be obtained.

CR K04 version, for connectors 4P + ⊕

2 pin versions available: yellow - red
Each pin has 2 possible specular insertion positions. Alternate use of the pins allows 4 coding combinations to be achieved.



CK 3 and 4 poles + ⊕ 10A - 230/400V

enclosures:
size "21.21"

page:

Insulating type	339 - 348
Metallic type	349 - 363
W-TYPE for aggressive environments	512 - 518
E-Xtreme® corrosion proof	538 - 539
EMC	564 - 572
IP68	628 - 631

- can be mated with CKSH inserts

inserts, 3 poles + ⊕ screw terminal connections



Q SILVER PLATED CONTACTS

inserts, 4 poles + ⊕ screw terminal connections



Q SILVER PLATED CONTACTS

description	part No.	part No.	part No.	part No.
distinctive colour	white	black	white	black
female inserts with female contacts ¹⁾	CKF 03	CKF 03 N	CKF 04	CKF 04 N
male inserts with male contacts	CKM 03	CKM 03 N	CKM 04	CKM 04 N
distinctive colour				
female inserts with female contacts ¹⁾				
male inserts with male contacts				

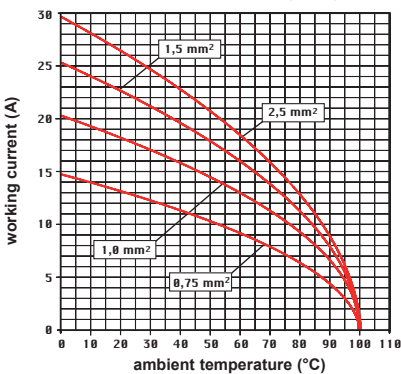
1) the female inserts can be mounted into the straight bulkhead housings CK I from the rear

- characteristics according to EN 61984:

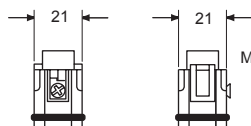
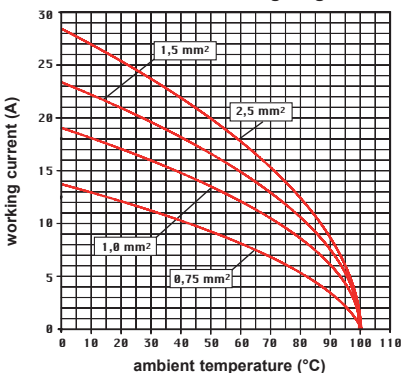
10A 230/400V 4kV 3
10A 400/690V 4kV 2

- certified
- rated voltage according to UL/CSA: 600V
- insulation resistance: ≥ 10 GΩ
- ambient temperature limit: -40 °C ... +100 °C
- made of self-extinguishing thermoplastic resin UL 94V-1
- mechanical life: ≥ 500 cycles
- contact resistance: ≤ 2 mΩ
- for max. current load see the connector inserts derating diagrams below; for more information see page 28

CK 03 poles connector inserts
Maximum current load derating diagram



CK 04 poles connector inserts
Maximum current load derating diagram

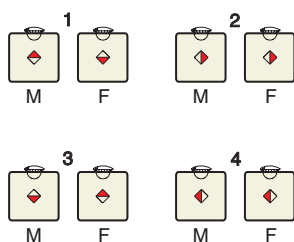


contacts side (front view)

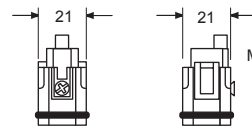


- inserts for wires with the following cross-sectional areas:
0,75 - 2,5 mm² - AWG 18 - 14
- conductor stripping length: 6 mm
- terminal screw torque: 0,5 Nm (4.4 lb.in), for more information see page 20 and 21

CR K03
coding pins
(page 688)



M = male insert
F = female insert

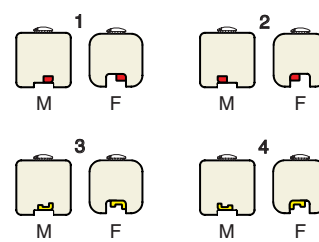


contacts side (front view)



- inserts for wires with the following cross-sectional areas:
0,75 - 2,5 mm² - AWG 18 - 14
- conductor stripping length: 6 mm
- terminal screw torque: 0,5 Nm (4.4 lb.in), for more information see page 20 and 21

CR K04R
and **CR K04G** coding
pins (page 688)



M = male insert
F = female insert

CKD 3 and 4 poles + ⊕ 10A - 230/400V

enclosures: size "21.21"	page:
Insulating type	339 - 348
Metallic type	349 - 363
W-TYPE for aggressive environments	512 - 518
E-Xtreme® corrosion proof	538 - 539
EMC	564 - 572
IP68	628 - 631

inserts, 3 poles + ⊕ screw terminal connections



Q GOLD PLATED CONTACTS

inserts, 4 poles + ⊕ screw terminal connections



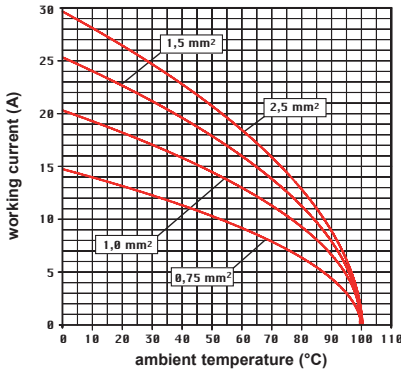
Q GOLD PLATED CONTACTS

description	part No.	part No.
female inserts with female contacts ¹⁾ male inserts with male contacts	CKFD 03 CKMD 03	CKFD 04 CKMD 04
female inserts with female contacts ¹⁾ male inserts with male contacts		

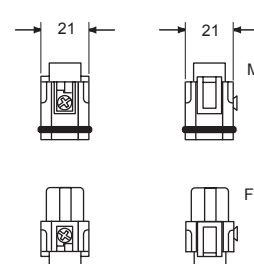
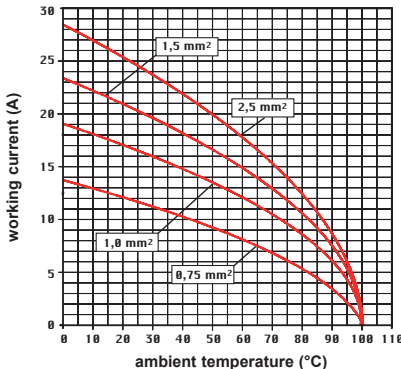
1) the female inserts can be mounted into the straight bulkhead housings CK I from the rear

- characteristics according to EN 61984:
10A 230/400V 4kV 3
10A 400/690V 4kV 2
- certified
- rated voltage according to UL/CSA: 600V
- insulation resistance: ≥ 10 GΩ
- ambient temperature limit: -40 °C ... +100 °C
- made of self-extinguishing thermoplastic resin UL 94V-1
- mechanical life: ≥ 500 cycles
- contact resistance: ≤ 2 mΩ
- for max. current load see the connector inserts derating diagrams below; for more information see page 28

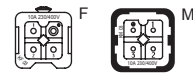
CKD 03 poles connector inserts
Maximum current load derating diagram



CKD 04 poles connector inserts
Maximum current load derating diagram

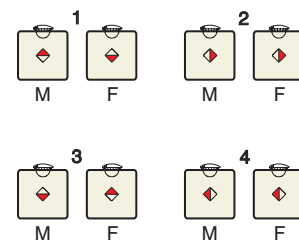


contacts side (front view)

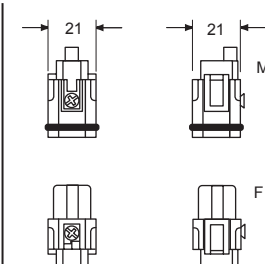


- inserts for wires with the following cross-sectional areas:
0,75 - 2,5 mm² - AWG 18 - 14
- conductor stripping length: 6 mm
- terminal screw torque: 0,5 Nm (4.4 lb.in), for more information see page 20 and 21

CR K03
coding pins
(page 688)



M = male insert
F = female insert

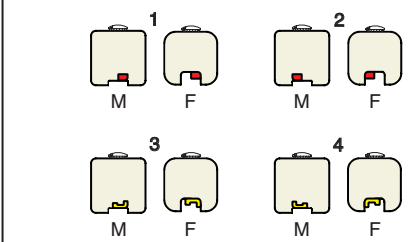


contacts side (front view)



- inserts for wires with the following cross-sectional areas:
0,75 - 2,5 mm² - AWG 18 - 14
- conductor stripping length: 6 mm
- terminal screw torque: 0,5 Nm (4.4 lb.in), for more information see page 20 and 21

CR K04R
and **CR K04G** coding pins
(page 688)



M = male insert
F = female insert

CK...RY 3 and 4 poles + ⊕ 10A - 230/400V

enclosures:
size "21.21"

page:

For 180 °C

583 - 586

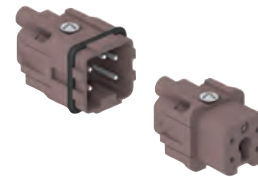
inserts, 3 poles + ⊕
screw terminal connections



🌡️ 180 °C

🔍 SILVER PLATED CONTACTS

inserts, 4 poles + ⊕
screw terminal connections



🌡️ 180 °C

🔍 SILVER PLATED CONTACTS

description

part No.

part No.

use at temperatures up to 180 °C
female inserts with female contacts ¹⁾, brown
male inserts with male contacts, brown

CKF 03 RY
CKM 03 RY

use at temperatures up to 180 °C
female inserts with female contacts ¹⁾, brown
male inserts with male contacts, brown

CKF 04 RY
CKM 04 RY

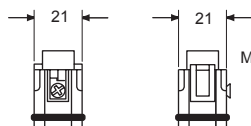
1) the female inserts can be mounted into the straight
bulkhead housings CK I from the rear

- characteristics according to EN 61984:

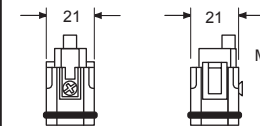
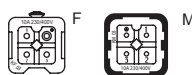
10A 230/400V 4kV 3
10A 400/690V 4kV 2

- certified

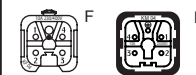
- rated voltage according to UL/CSA: 600V
- insulation resistance: ≥ 10 GΩ
- ambient temperature limit: -40 °C ... +180 °C
- made of self-extinguishing thermoplastic resin UL 94V-0
- mechanical life: ≥ 500 cycles
- contact resistance: ≤ 2 mΩ
- for max. current load see the connector inserts derating diagrams below; for more information see page 28



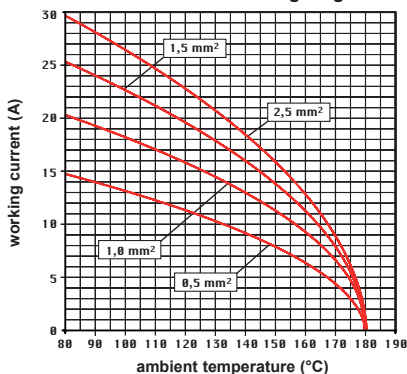
contacts side (front view)



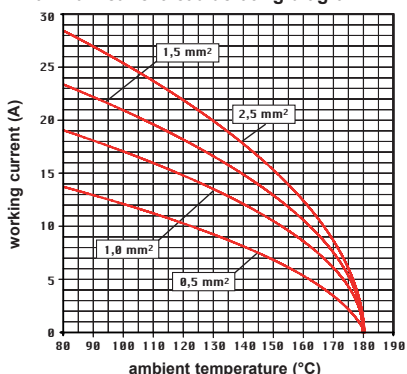
contacts side (front view)



CK...RY 03 poles connector inserts
Maximum current load derating diagram



CK...RY 04 poles connector inserts
Maximum current load derating diagram



- inserts for wires with the following cross-sectional areas:
0,75 - 2,5 mm² - AWG 18 - 14
- conductor stripping length: 6 mm
- terminal screw torque: 0,5 Nm (4.4 lb.in), for more information see page 20 and 21

- inserts for wires with the following cross-sectional areas:
0,75 - 2,5 mm² - AWG 18 - 14
- conductor stripping length: 6 mm
- terminal screw torque: 0,5 Nm (4.4 lb.in), for more information see page 20 and 21

CK...RY

CKSH-SQUICH® series

Easy wiring in a compact space

These small but very capable connector inserts sized “21.21” are the evolution of former patented CKS series, still available upon request: thanks to a further step ahead in ILME proprietary solutions, they implement the fast, tool-less and skill-independent SQUICH® technology even in such a narrow space.

Reliable spring clamp contacts are now faster to wire thanks to the presence – also on the protective earth terminal – of the actuator pushbuttons, whose colour coding provides further visual help in identifying their function. Each pushbutton safely allows the insertion of a measuring probe even upon connector wired and under load, and is featured with a side slot for the possible spring terminal re-opening, by using a simple 0,5x3 mm flat blade screwdriver.

The conductor entries are on the top rear of the connector insert, as in former CKS inserts, providing **vertical straight terminations**, whereas screw-type CK inserts have lateral conductor entries and terminal screws on the top rear. CKSH connector inserts are available in the traditional two polarities: 3P+ ⊕ and 4P+ ⊕, for applications with rated voltage up to 400V AC or DC and continuous rated current per pole up to 10A.

These connector inserts inherit the proprietary optional coding system introduced in the recently renewed series CK and CKS, to prevent mismatching in case of multiple connectors installed close to each other. This coding system does not alter the mating face, so connectors not making use of it are fully backwards mating compatible with former products. They are fully interchangeable, with even improved performances, to the legacy much appreciated screw-type series CK (230/400V) and CKS (spring terminals), which they replace.



SUM UP

- ☑ Easy wiring in compact size
- ☑ All the advantages of ILME SQUICH® connection in size 21.21
- ☑ Vertical and straight termination
- ☑ Full 400V voltage rating compared to 230/400V of series CK
- ☑ Built-in silver plated contacts

Requiring no wiring tool and no special wire preparation, they provide **excellent conductor fastening** with great resistance to strong vibrations.

Connecting capacity of terminals is from 0,14 mm² to 2,5 mm² (26 to 14 AWG) for unprepared conductors. Use of prepared conductors (terminated with crimped ferrule) is up to 1,5 mm² /16 AWG, suitable to rated current up to 10A per pole, due to the relatively limited number of poles.



no need of wiring tools



already open terminals



reduced wiring time



quick identification of wired terminals

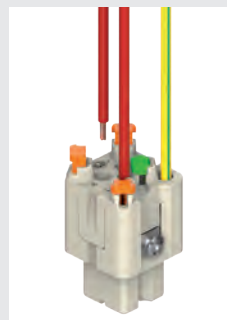


☑ Easy wiring in compact size



☑ With coding pins

☑ Rear top entry for an easier wiring



☑ For solid or flexible wires and for crimped ferrules



CKSH-SQUICH® series

TECHNICAL FEATURES

Insert series		CKSH-SQUICH®
No. of poles	Main contacts + ⊕	3, 4
	auxiliary contacts	—
Rated current ¹⁾		10A
EN IEC 61984	rated voltage	400V
	rated impulse withstand voltage	4kV
	pollution degree	3
EN IEC 61984	rated voltage	690V
	rated impulse withstand voltage	4kV
	pollution degree	2
UL / CSA certification	rated voltage (a.c./d.c.)	600V
Contact resistance		≤ 3 mΩ
Insulation resistance		≥ 10 GΩ
Ambient temperature limit (°C)	min	-40
	max	125
Degree of protection	with enclosures (according to type)	IP44 , IP66/ IP67 /IP69, IP66/ IP68 /IP69, (according to type and model)
	without enclosures (in mated condition) - termination side on male and female inserts - mating side on female inserts	IP20 (IPXXB)
Conductor connections		spring type with actuator button
Conductor cross-sectional area	mm ²	0,14 - 2,5 unprepared
		0,14 - 1,5 prepared with crimped ferrule
	AWG	26 - 14 unprepared
		26 - 16 prepared with crimped ferrule
Mechanical endurance (mating cycles)		≥ 500

1) Please check the inserts derating diagrams to establish the actual maximum operating current according to the ambient temperature, the conductor cross-sectional area, the polarity of the connector, and any external constraint may derive e.g. by the continuous operating temperature sustained by the chosen conductor sheathing or by end-product safety standards fixing max allowed temperature rise on terminals (e.g. 30 K, 45 K or 50 K)

CKSH-SQUICH® 3 and 4 poles + ⊕ 10A - 400V

enclosures: size "21.21"	page:
Insulating type	339 - 348
Metallic type	349 - 363
W-TYPE for aggressive environments	512 - 518
E-Xtreme® corrosion proof	538 - 539
EMC	564 - 572
IP68	628 - 631

- can be mated with CK inserts

inserts, 3 poles + ⊕ spring terminal connection without tools



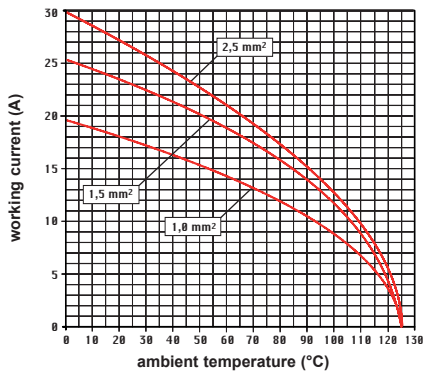
inserts, 4 poles + ⊕ spring terminal connection without tools



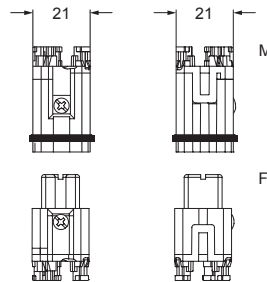
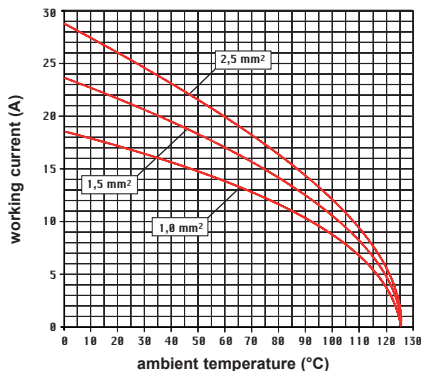
description	part No.	part No.
female inserts with female contacts	CKSHF 03	CKSHF 04
male inserts with male contacts	CKSHM 03	CKSHM 04
female inserts with female contacts		
male inserts with male contacts		

- characteristics according to EN 61984:
10A 400V 4kV 3
10A 690V 4kV 2
- cULus (UL for USA and Canada), DNV-GL, BUREAU VERITAS, ERI certified
- rated voltage according to UL/CSA: 600V
- insulation resistance: $\geq 10 \text{ G}\Omega$
- ambient temperature limits: $-40 \text{ }^\circ\text{C} \dots +125 \text{ }^\circ\text{C}$
- made of self-extinguishing thermoplastic resin UL 94V-0
- mechanical life: ≥ 500 cycles
- contact resistance: $\leq 3 \text{ m}\Omega$
- for max. current load see the connector inserts derating diagrams below; for more information see page 28

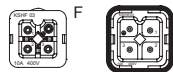
CKSH 03 poles connector inserts
Maximum current load derating diagram



CKSH 04 poles connector inserts
Maximum current load derating diagram



contacts side (front view)

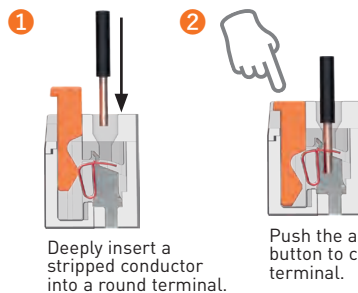


- inserts for wires with the following cross-sectional areas: 0,14 - 2,5 mm² - AWG 26 - 14 for prepared wires useable section: up to 1,5 mm² (AWG 16)
- conductor stripping length: 9...11 mm

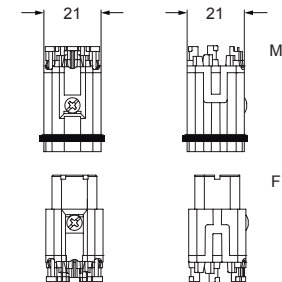
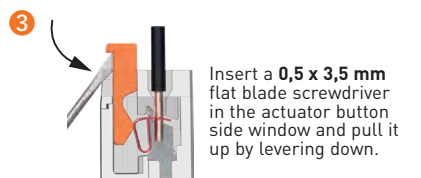
CR K03
coding pins
(page 688)



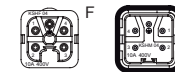
SQUICH®-spring connection technology WIRING



RE-OPENING



contacts side (front view)

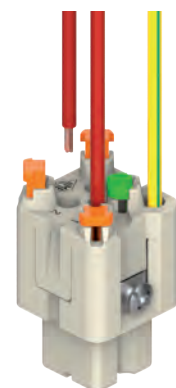


- inserts for wires with the following cross-sectional areas: 0,14 - 2,5 mm² - AWG 26 - 14 for prepared wires useable section: up to 1,5 mm² (AWG 16)
- conductor stripping length: 9...11 mm

CR K04R
and **CR K04G** coding pins
(page 688)



Rear top entry of wires for an easier wiring



CD - CDD series

CD series

It is a multipole connector series for crimped connections made with removable crimp contacts **CD** series.

There are 5 different sizes available (6 polarities):

- "21.21" with two inserts, respectively **CD 07** (7 P + ⊕) and **CD 08** (8 P) for SELV applications;

NOTE – These two polarities are coded to avoid their incorrect cross-mating. **CD 07**, being equipped with a pass-through PE connection that does not serve as equipotential bonding of a metal enclosure, is suitably safety-coded to avoid mismatch with a metal enclosure of this size.

- "49.16" with **CD 15** (15 P + ⊕) provided by 3 rows of 5 contact seats each;
- "66.16" with **CD 25** (25 P + ⊕) provided by 2 outer rows of 9 contact seats each and 1 inner row with 7 contact seats;
- "77.27" with **CD 40** (40 P + ⊕) provided by 4 rows of 10 contact seats each;
- "104.27" with **CD 64** (64 P + ⊕) provided by 4 rows of 16 contact seats each.

It is also possible to mount **two inserts side-by-side in a connector enclosure** is also given:

- for inserts size "66.16" (**CD 25 + CD 25 Z**) to get a **50 P + ⊕** connector with connector enclosures size "66.40";
- for inserts size "77.27" (**CD 40 + CD 40**) to get an **80 P + ⊕** connector with connector enclosures size "77.62";
- for inserts size "104.27" (**CD 64 + CD 64**) to get a **128 P + ⊕** connector with connector enclosures size "104.62".

The last four sizes of the first list are described in **EN 175 301-801:2006** European standard, which derives from the old German standard **DIN 43 652**, whose first edition dates back to the Seventies of last century. This standard provides dimensional standardization for these four sizes of connector inserts as well as for **CD series crimp contacts**, solid, machined, used by these connectors, and of the main types (and sizes) of relevant **connector enclosures**, including interface dimensions between the connector inserts and the relevant connector hood or housing, overall dimensions of locking levers and pegs, etc. This standard provides ground for the dimensional standardization of the other connector sizes (e.g. "44.27", "57.27") for all series of connector inserts with the same size and for all connector enclosure series with these sizes.

As for any series of connector inserts for crimped connections, the polarity is to be intended as "up to", being always possible to fit a connector insert with a reduced number of crimped connections, suiting the specific application. In this regard, see e.g. next page for use of **CD** series connector inserts at special (higher) voltages.

These connectors cover applications for rated voltage up to **250V AC/DC in pollution degree 3** (industrial environment) when connectors are fully equipped with contacts, and for rated currents up to **10A** per pole (derating diagram show actual current carrying capacity as a function of number of poles, conductor size and ambient temperature).

The PE connection for size "21.21" **CD 07** is a pass-through (crimp) connection that does not provide equipotential bonding to earth to a possible metal connector enclosure, hence the safety coding implemented in inserts **CDM 07** and **CDF 07** to avoid mismatch with metal enclosures.

The PE connection for the other sizes is provided by a screw terminal on the side of pole #1, and by lateral mating contacts. The PE terminal of the inserts provide earthing to the metal enclosures.

CDD series

It is the high density evolution of **CD** series. It provides choice of **5 different sizes** (5 polarities) of multipole connector inserts for crimped connections made with removable crimp contacts **CD** series:

- "44.27" with **CDD 24** (24 P + ⊕) provided by 6 rows of 4 contact seats each;
- "66.16" with **CDD 38** (38 P + ⊕) provided by 2 outer rows of 10 contact seats each and 2 inner rows with 9 contact seats each;
- "57.27" with **CDD 42** (42 P + ⊕) provided by 6 rows of 7 contact seats each;
- "77.27" with **CDD 72** (72 P + ⊕) provided by 6 rows of 12 contact seats each;
- "104.27" with **CDD 108** (108 P + ⊕) provided by 6 rows of 18 contact seats each.

It is also possible to mount two inserts side-by-side in a connector enclosure is also provided:

- for inserts size "66.16" (**CDD 38 + CDD 38**) to get a **76 P + ⊕** connector with connector enclosures size "66.40";
- for inserts size "77.27" (**CDD 72 + CDD 72**) to get a **144 P + ⊕** connector with connector enclosures size "77.62";
- for inserts size "104.27" (**CDD 108 + CDD 108**) to get a **216 P + ⊕** connector with connector enclosures size "104.62".

These connectors cover applications for rated voltage up to **250 VAC/DC in pollution degree 2** (suitable for industrial environment once used inside enclosures >IP54) when connectors are fully equipped with contacts, and for rated currents up to 10A per pole (derating diagram show actual current carrying capacity as a function of number of poles, conductor size and ambient temperature).

The PE connection for all sizes is provided by a screw terminal on the side of pole #1, and lateral mating contacts. The PE terminal of the inserts provide earthing to the metal enclosures.

Even when the coding function is not required, **it is highly recommended to use CRM and CRF coding pins** (see pages 685, 686 in this catalogue) **with CD and CDD connector inserts**, to reduce movements when mating and unmating the connectors, to avoid contact damage. To this aim, standard EN 175 301-801:2006 specifies a max allowed angular longitudinal fluctuation of $\pm 5^\circ$.

Special voltages for CD series

If all the contacts are used, CD connector inserts may be used with voltage up to 250V (first column) pollution degree 3 in accordance with standard EN 61984.

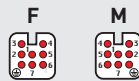
If the number of contacts is reduced and the contacts assigned accordingly, these connectors may be used at higher voltages. This is possible because the decrease in the number of contacts leads

to an increase in clearances (insulating distances in air) and creepage distances (insulating distances along the surface).

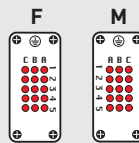
When the contacts are arranged as shown below, the inserts may be used at rated voltage of 500V (second column) pollution degree 3 in accordance with standard EN 61984.

**For use up to 250V
pollution degree 3**
diagrams
contacts side (front view)

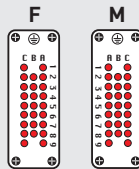
CD 07 - 7 + ⊕



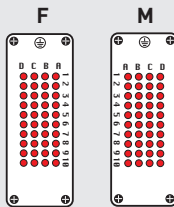
CD 15 - 15 + ⊕



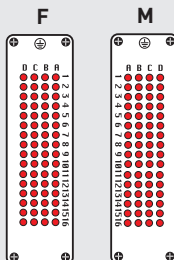
CD 25 - 25 + ⊕



CD 40 - 40 + ⊕

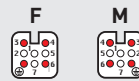


CD 64 - 64 + ⊕

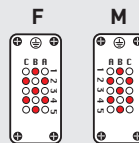


**For use up to 500V
pollution degree 3**
diagrams
contacts side (front view)

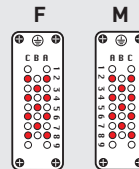
CD 07 - 3 + ⊕



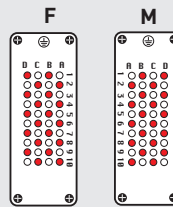
CD 15 - 7 + ⊕



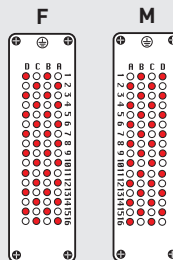
CD 25 - 11 + ⊕



CD 40 - 20 + ⊕



CD 64 - 32 + ⊕



Legend:

- working contact
- without contact
- M = male insert
- F = female insert

CD 7 poles + ⊕ 10A - 250V

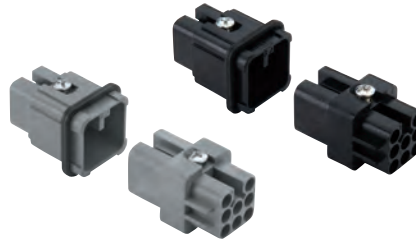
enclosures:
size "21.21"

page:

Insulating type

339 - 348

inserts, crimp connections



10A crimp contacts silver and gold plated



description	part No.	part No.	part No.	part No.
without contacts (to be ordered separately)	grey	black		
female inserts for female contacts, grey and black ¹⁾	CDF 07	CDM 07 N		
male inserts for male contacts, grey and black	CDM 07	CDM 07 N		
10A female contacts				
0,14-0,37 mm ² AWG 26-22 identification No. 1			CDFA 0.3	CDFD 0.3
0,5 mm ² AWG 20 identification No. 2			CDFA 0.5	CDFD 0.5
0,75 mm ² AWG 18 identification No. ②			CDFA 0.7	CDFD 0.7
1 mm ² AWG 18 identification No. 3			CDFA 1.0	CDFD 1.0
1,5 mm ² AWG 16 identification No. 4			CDFA 1.5	CDFD 1.5
2,5 mm ² AWG 14 identification No. 5			CDFA 2.5	CDFD 2.5
10A male contacts				
0,14-0,37 mm ² AWG 26-22 identification No. 1			CDMA 0.3	CDMD 0.3
0,5 mm ² AWG 20 identification No. 2			CDMA 0.5	CDMD 0.5
0,75 mm ² AWG 18 identification No. ②			CDMA 0.7	CDMD 0.7
1 mm ² AWG 18 identification No. 3			CDMA 1.0	CDMD 1.0
1,5 mm ² AWG 16 identification No. 4			CDMA 1.5	CDMD 1.5
2,5 mm ² AWG 14 identification No. 5			CDMA 2.5	CDMD 2.5

silver plated

gold plated+

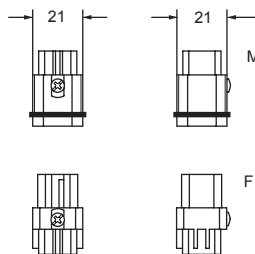
1) the female inserts can be mounted into the straight bulkhead housings CK I from the rear

- characteristics according to EN 61984:

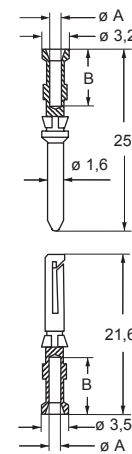
10A 250V 4kV 3
10A 230/400V 4kV 2

- certified

- rated voltage according to UL/CSA: 600V
- insulation resistance: ≥ 10 GΩ
- ambient temperature limit: -40 °C ... +125 °C
- made of self-extinguishing thermoplastic resin UL 94V-0
- mechanical life: ≥ 500 cycles
- contact resistance: ≤ 3 mΩ
- for applications requiring higher voltages, please see the special voltage application section on page 65
- **it is recommended to crimp the contacts with crimping tools homologated by ILME** (please see the crimping tool section 10A contacts, CDF and CDM series on pages 708 - 741)
- for max. current load see the connector inserts derating diagram below; for more information see page 28



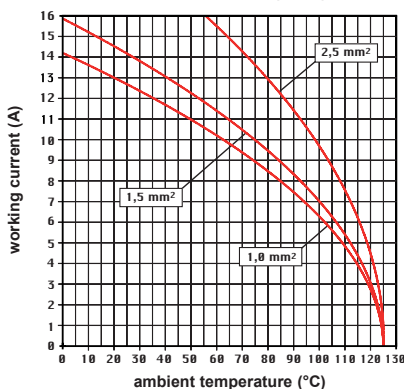
contacts side (front view)



CDF and CDM contacts

conductor section mm ²	conductor slot ø A (mm)	conductors stripping length B (mm)
0,14-0,37	0,9	8
0,5	1,1	8
0,75	1,3	8
1,0	1,45	8
1,5	1,8	8
2,5	2,2	6

CD 07 poles connector inserts
Maximum current load derating diagram



CR CP coding pin with loss of one contact (page 689)



+ for basic or high thickness gold plating, please refer to page 674

CD 8 poles 10A - 50V ac / 120V dc

enclosures: size "21.21"	page:
Insulating type	339 - 348
Metallic type	349 - 363
W-TYPE for aggressive environments	512 - 518
E-Extreme® corrosion proof	538 - 539
EMC	564 - 572
IP68	628 - 631

inserts, crimp connections



10A crimp contacts silver and gold plated

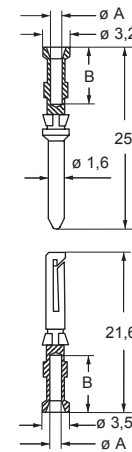
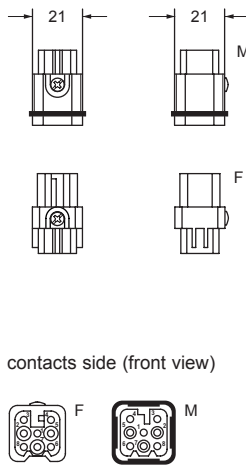


description	part No.	part No.	part No.
without contacts (to be ordered separately)			
female inserts for female contacts ¹⁾	CDF 08		
male inserts for male contacts	CDM 08		
10A female contacts			
0,14-0,37 mm ² AWG 26-22 identification No. 1		CDFA 0.3	CDFD 0.3
0,5 mm ² AWG 20 identification No. 2		CDFA 0.5	CDFD 0.5
0,75 mm ² AWG 18 identification No. ②		CDFA 0.7	CDFD 0.7
1 mm ² AWG 18 identification No. 3		CDFA 1.0	CDFD 1.0
1,5 mm ² AWG 16 identification No. 4		CDFA 1.5	CDFD 1.5
2,5 mm ² AWG 14 identification No. 5		CDFA 2.5	CDFD 2.5
10A male contacts			
0,14-0,37 mm ² AWG 26-22 identification No. 1		CDMA 0.3	CDMD 0.3
0,5 mm ² AWG 20 identification No. 2		CDMA 0.5	CDMD 0.5
0,75 mm ² AWG 18 identification No. ②		CDMA 0.7	CDMD 0.7
1 mm ² AWG 18 identification No. 3		CDMA 1.0	CDMD 1.0
1,5 mm ² AWG 16 identification No. 4		CDMA 1.5	CDMD 1.5
2,5 mm ² AWG 14 identification No. 5		CDMA 2.5	CDMD 2.5

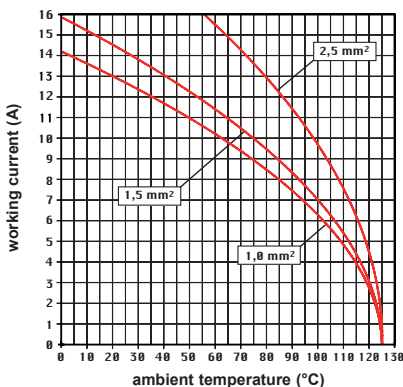
1) the female inserts can be mounted into the straight bulkhead housings CK I from the rear

- characteristics according to EN 61984:
10A 50V ac / 120V dc 0,8kV 3
- certified

- rated voltage according to UL/CSA: 50V ac / 120V dc
- insulation resistance: $\geq 10 \text{ G}\Omega$
- ambient temperature limit: -40 °C ... +125 °C
- made of self-extinguishing thermoplastic resin UL 94V-0
- mechanical life: ≥ 500 cycles
- contact resistance: $\leq 3 \text{ m}\Omega$
- for applications requiring higher voltages, please see the special voltage application section on page 65
- **it is recommended to crimp the contacts with crimping tools homologated by ILME** (please see the crimping tool section 10A contacts, CDF and CDM series on pages 708 - 741)
- for max. current load see the connector inserts derating diagram below; for more information see page 28



CD 08 poles connector inserts
Maximum current load derating diagram



CR CP coding pin with loss of one contact (page 689)



CDF and CDM contacts

conductor section mm ²	conductor slot ø A (mm)	conductors stripping length B (mm)
0,14-0,37	0,9	8
0,5	1,1	8
0,75	1,3	8
1,0	1,45	8
1,5	1,8	8
2,5	2,2	6

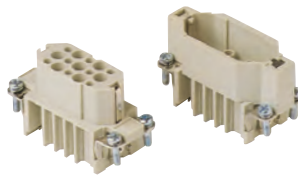
⁺ for basic or high thickness gold plating, please refer to page 674

CD 15 poles + ⊕ 10A - 250V

enclosures: size "49.16"	page:
IL-BRID	374 - 377, 382
CZ7 IP67, single lever	384
W-TYPE for aggressive environments	519
E-Xtreme® corrosion proof	540
EMC	576

panel supports: COB + adaptor	page: 652 - 654
----------------------------------	--------------------

inserts, crimp connections



10A crimp contacts silver and gold plated



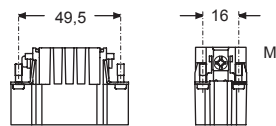
description	part No.	part No.	part No.
without contacts (to be ordered separately)			
female inserts for female contacts	CD F 15		
male inserts for male contacts	CD M 15		
10A female contacts			
0,14-0,37 mm ² AWG 26-22 identification No. 1		CDFA 0.3	CDFD 0.3
0,5 mm ² AWG 20 identification No. 2		CDFA 0.5	CDFD 0.5
0,75 mm ² AWG 18 identification No. ②		CDFA 0.7	CDFD 0.7
1 mm ² AWG 18 identification No. 3		CDFA 1.0	CDFD 1.0
1,5 mm ² AWG 16 identification No. 4		CDFA 1.5	CDFD 1.5
2,5 mm ² AWG 14 identification No. 5		CDFA 2.5	CDFD 2.5
10A male contacts			
0,14-0,37 mm ² AWG 26-22 identification No. 1		CDMA 0.3	CDMD 0.3
0,5 mm ² AWG 20 identification No. 2		CDMA 0.5	CDMD 0.5
0,75 mm ² AWG 18 identification No. ②		CDMA 0.7	CDMD 0.7
1 mm ² AWG 18 identification No. 3		CDMA 1.0	CDMD 1.0
1,5 mm ² AWG 16 identification No. 4		CDMA 1.5	CDMD 1.5
2,5 mm ² AWG 14 identification No. 5		CDMA 2.5	CDMD 2.5

- characteristics according to EN 61984:

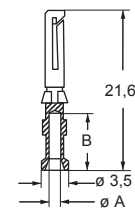
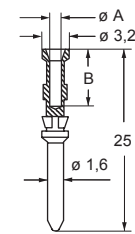
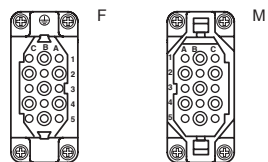
10A 250V 4kV 3
10A 230/400V 4kV 2

- cULus (UL for USA and Canada),
BUREAU VERITAS EAC certified

- rated voltage according to UL/CSA: 600V
- insulation resistance: ≥ 10 GΩ
- ambient temperature limit: -40 °C ... +125 °C
- made of self-extinguishing thermoplastic resin UL 94V-0
- mechanical life: ≥ 500 cycles
- contact resistance: ≤ 3 mΩ
- for applications requiring higher voltages, please see the special voltage application section on page 65
- **it is recommended to crimp the contacts with crimping tools homologated by ILME** (please see the crimping tool section 10A contacts, CDF and CDM series on pages 708 - 741)
- for max. current load see the connector inserts derating diagram below; for more information see page 28



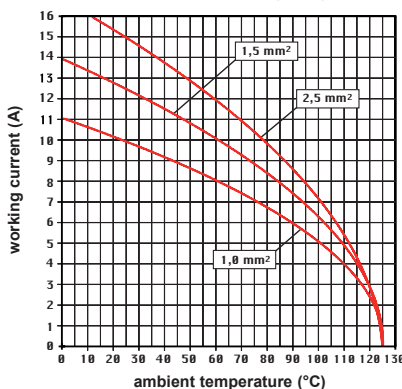
contacts side (front view)



CDF and CDM contacts

conductor section mm ²	conductor slot ø A (mm)	conductors stripping length B (mm)
0,14-0,37	0,9	8
0,5	1,1	8
0,75	1,3	8
1,0	1,45	8
1,5	1,8	8
2,5	2,2	6

CD 15 poles connector inserts
Maximum current load derating diagram



CR CP coding pin with loss of one contact (page 689)



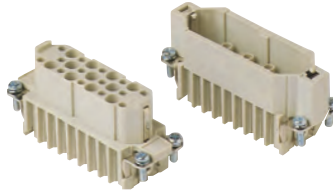
† for basic or high thickness gold plating, please refer to page 674

CD 25 poles + ⊕ 10A - 250V

enclosures: size "66.16"	page:
IL-BRID	378 - 382
CZ7 IP67, single lever	385
W-TYPE for aggressive environments	520
E-Xtreme® corrosion proof	541
EMC	577

panel supports: COB + adaptor	page: 652 - 654
----------------------------------	--------------------

inserts, crimp connections



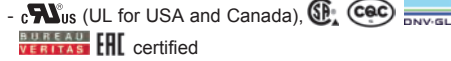
10A crimp contacts silver and gold plated



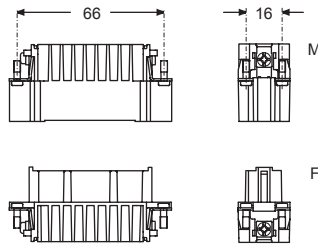
description	part No.	part No.	part No.
without contacts (to be ordered separately)			
female inserts for female contacts	CDF 25		
male inserts for male contacts	CDM 25		
10A female contacts			
0,14-0,37 mm ² AWG 26-22 identification No. 1		CDFA 0.3	CDFD 0.3
0,5 mm ² AWG 20 identification No. 2		CDFA 0.5	CDFD 0.5
0,75 mm ² AWG 18 identification No. ②		CDFA 0.7	CDFD 0.7
1 mm ² AWG 18 identification No. 3		CDFA 1.0	CDFD 1.0
1,5 mm ² AWG 16 identification No. 4		CDFA 1.5	CDFD 1.5
2,5 mm ² AWG 14 identification No. 5		CDFA 2.5	CDFD 2.5
10A male contacts			
0,14-0,37 mm ² AWG 26-22 identification No. 1		CDMA 0.3	CDMD 0.3
0,5 mm ² AWG 20 identification No. 2		CDMA 0.5	CDMD 0.5
0,75 mm ² AWG 18 identification No. ②		CDMA 0.7	CDMD 0.7
1 mm ² AWG 18 identification No. 3		CDMA 1.0	CDMD 1.0
1,5 mm ² AWG 16 identification No. 4		CDMA 1.5	CDMD 1.5
2,5 mm ² AWG 14 identification No. 5		CDMA 2.5	CDMD 2.5

- characteristics according to EN 61984:

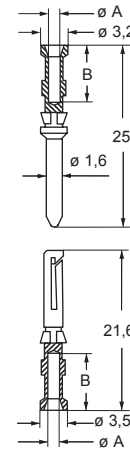
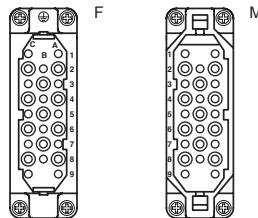
10A 250V 4kV 3
10A 230/400V 4kV 2



- rated voltage according to UL/CSA: 600V
- insulation resistance: ≥ 10 GΩ
- ambient temperature limit: -40 °C ... +125 °C
- made of self-extinguishing thermoplastic resin UL 94V-0
- mechanical life: ≥ 500 cycles
- contact resistance: ≤ 3 mΩ
- for applications requiring higher voltages, please see the special voltage application section on page 65
- **it is recommended to crimp the contacts with crimping tools homologated by ILME** (please see the crimping tool section 10A contacts, CDF and CDM series on pages 708 - 741)
- for max. current load see the connector inserts derating diagram below; for more information see page 28



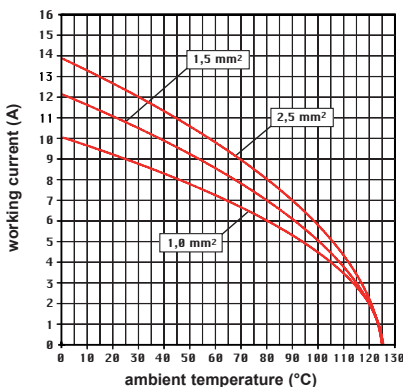
contacts side (front view)



CDF and CDM contacts

conductor section mm ²	conductor slot ø A (mm)	conductors stripping length B (mm)
0,14-0,37	0,9	8
0,5	1,1	8
0,75	1,3	8
1,0	1,45	8
1,5	1,8	8
2,5	2,2	6

CD 25 poles connector inserts
Maximum current load derating diagram



CR CP coding pin with loss of one contact (page 689)

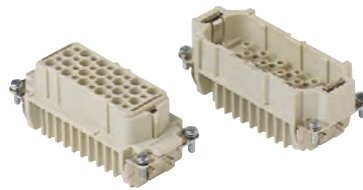


+ for basic or high thickness gold plating, please refer to page 674

CD 40 poles + ⊕ 10A - 250V

enclosures: size "77.27"	page:
C-TYPE IP65 or IP66/IP69	402 - 411
C7 IP67, two levers	439 - 440
V-TYPE IP65 or IP66/IP69, single lever	454 - 458
BIG hoods	470 - 471
T-TYPE IP65 insulating	484 - 485
T-TYPE / W IP66/IP69 insulating	491
HYGIENIC T-TYPE / H IP66/IP69	503
HYGIENIC T-TYPE / C IP66/IP69, -50 °C	508
W-TYPE for aggressive environments	523
E-Xtreme® corrosion proof	534 - 535, 544, 554 - 555
EMC	580
Central lever	609 - 611
LS-TYPE	622 - 623
IP68	640 - 643
panel supports: COB	page: 652 - 653

inserts, crimp connections



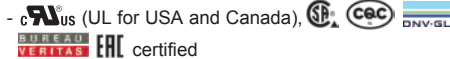
10A crimp contacts silver and gold plated



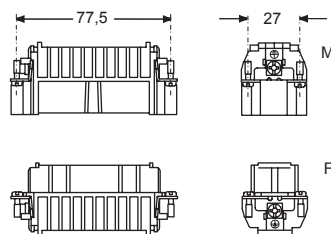
description	part No.	part No.	part No.
without contacts (to be ordered separately)			
female inserts for female contacts	CDF 40		
male inserts for male contacts	CDM 40		
10A female contacts			
0,14-0,37 mm ² AWG 26-22 identification No. 1		CDFA 0.3	CDFD 0.3
0,5 mm ² AWG 20 identification No. 2		CDFA 0.5	CDFD 0.5
0,75 mm ² AWG 18 identification No. ②		CDFA 0.7	CDFD 0.7
1 mm ² AWG 18 identification No. 3		CDFA 1.0	CDFD 1.0
1,5 mm ² AWG 16 identification No. 4		CDFA 1.5	CDFD 1.5
2,5 mm ² AWG 14 identification No. 5		CDFA 2.5	CDFD 2.5
10A male contacts			
0,14-0,37 mm ² AWG 26-22 identification No. 1		CDMA 0.3	CDMD 0.3
0,5 mm ² AWG 20 identification No. 2		CDMA 0.5	CDMD 0.5
0,75 mm ² AWG 18 identification No. ②		CDMA 0.7	CDMD 0.7
1 mm ² AWG 18 identification No. 3		CDMA 1.0	CDMD 1.0
1,5 mm ² AWG 16 identification No. 4		CDMA 1.5	CDMD 1.5
2,5 mm ² AWG 14 identification No. 5		CDMA 2.5	CDMD 2.5

- characteristics according to EN 61984:

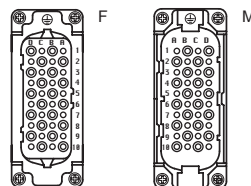
10A 250V 4kV 3
10A 230/400V 4kV 2



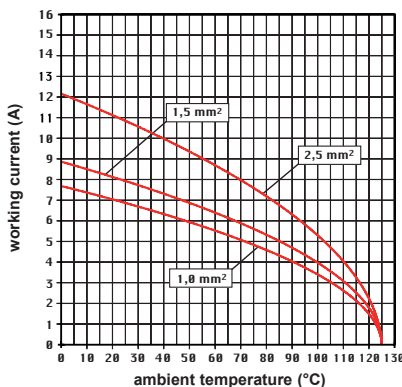
- rated voltage according to UL/CSA: 600V
- insulation resistance: ≥ 10 GΩ
- ambient temperature limit: -40 °C ... +125 °C
- made of self-extinguishing thermoplastic resin UL 94V-0
- mechanical life: ≥ 500 cycles
- contact resistance: ≤ 3 mΩ
- for applications requiring higher voltages, please see the special voltage application section on page 65
- **it is recommended to crimp the contacts with crimping tools homologated by ILME** (please see the crimping tool section 10A contacts, CDF and CDM series on pages 708 - 741)
- for max. current load see the connector inserts derating diagram below; for more information see page 28



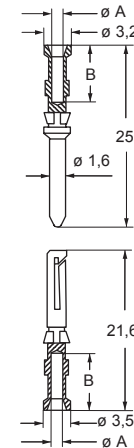
contacts side (front view)



CD 40 poles connector inserts
Maximum current load derating diagram



CR CP coding pin
with loss of one contact
(page 689)



CDF and CDM contacts

conductor section mm ²	conductor slot ø A (mm)	conductors stripping length B (mm)
0,14-0,37	0,9	8
0,5	1,1	8
0,75	1,3	8
1,0	1,45	8
1,5	1,8	8
2,5	2,2	6

† for basic or high thickness gold plating, please refer to page 674

CD 50 poles + ⊕ 10A - 250V

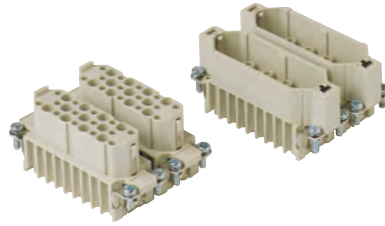
enclosures:
size "66.40"

page:

C-TYPE IP65 or IP66/IP69
W-TYPE for aggressive environments
E-Xtreme® corrosion proof

431 - 434
527
548

inserts, crimp connections



10A crimp contacts silver and gold plated



description	part No.	part No.	part No.	part No.
without contacts (to be ordered separately)				
female inserts, No. (A1÷C9) and (ZA1÷ZC9) *	CDF 25	CDF 25 Z		
male inserts, No. (A1÷C9) and (ZA1÷ZC9) *	CDM 25	CDM 25 Z		
10A female contacts				
0,14-0,37 mm ² AWG 26-22 identification No. 1			CDFA 0.3	CDFD 0.3
0,5 mm ² AWG 20 identification No. 2			CDFA 0.5	CDFD 0.5
0,75 mm ² AWG 18 identification No. ②			CDFA 0.7	CDFD 0.7
1 mm ² AWG 18 identification No. 3			CDFA 1.0	CDFD 1.0
1,5 mm ² AWG 16 identification No. 4			CDFA 1.5	CDFD 1.5
2,5 mm ² AWG 14 identification No. 5			CDFA 2.5	CDFD 2.5
10A male contacts				
0,14-0,37 mm ² AWG 26-22 identification No. 1			CDMA 0.3	CDMD 0.3
0,5 mm ² AWG 20 identification No. 2			CDMA 0.5	CDMD 0.5
0,75 mm ² AWG 18 identification No. ②			CDMA 0.7	CDMD 0.7
1 mm ² AWG 18 identification No. 3			CDMA 1.0	CDMD 1.0
1,5 mm ² AWG 16 identification No. 4			CDMA 1.5	CDMD 1.5
2,5 mm ² AWG 14 identification No. 5			CDMA 2.5	CDMD 2.5

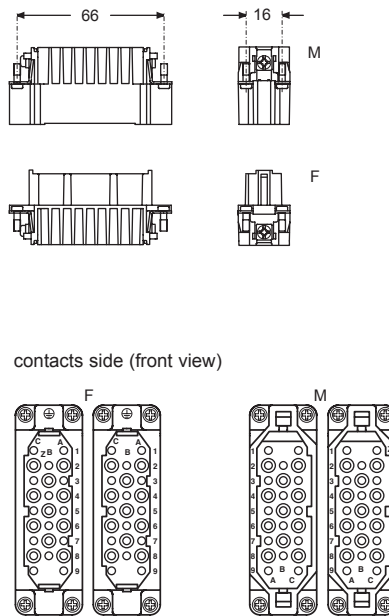
* coding compliant with EUROMAP recommendations

- characteristics according to EN 61984:

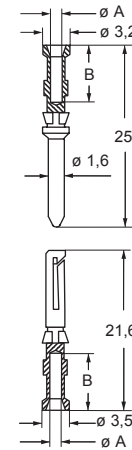
10A 250V 4kV 3
10A 230/400V 4kV 2

- cULus (UL for USA and Canada),
BUREAU VERITAS ERI certified

- rated voltage according to UL/CSA: 600V
- insulation resistance: ≥ 10 GΩ
- ambient temperature limit: -40 °C ... +125 °C
- made of self-extinguishing thermoplastic resin UL 94V-0
- mechanical life: ≥ 500 cycles
- contact resistance: ≤ 3 mΩ
- for applications requiring higher voltages, please see the special voltage application section on page 65
- **it is recommended to crimp the contacts with crimping tools homologated by ILME** (please see the crimping tool section 10A contacts, CDF and CDM series on pages 708 - 741)
- for max. current load see the connector inserts derating diagram below; for more information see page 28



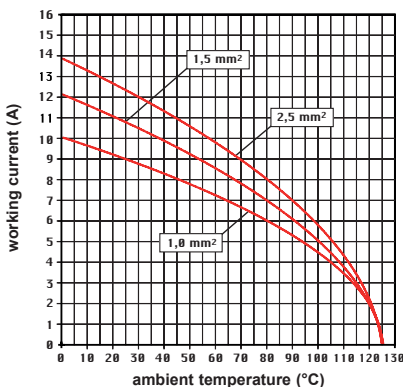
contacts side (front view)



CDF and CDM contacts

conductor section mm ²	conductor slot ϕA (mm)	conductors stripping length B (mm)
0,14-0,37	0,9	8
0,5	1,1	8
0,75	1,3	8
1,0	1,45	8
1,5	1,8	8
2,5	2,2	6

CD 50 poles connector inserts
Maximum current load derating diagram



CR CP coding pin
with loss of one contact
(page 689)

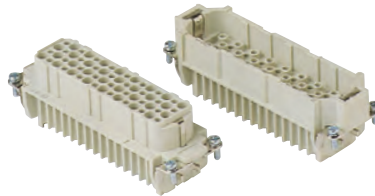


+ for basic or high thickness gold plating, please refer to page 674

CD 64 poles + ⊕ 10A - 250V

enclosures: size "104.27"	page:
C-TYPE IP65 or IP66/IP69	412 - 423
C7 IP67, two levers	441 - 442
V-TYPE IP65 or IP66/IP69, single lever	459 - 463
BIG hoods	472 - 473
T-TYPE IP65 insulating	486 - 487
T-TYPE / W IP66/IP69 insulating	492
HYGIENIC T-TYPE / H IP66/IP69	504
HYGIENIC T-TYPE / C IP66/IP69, -50 °C	509
W-TYPE for aggressive environments	524
E-Xtreme® corrosion proof	536 - 537, 545, 556 - 557
EMC	581
Central lever	612 - 614
LS-TYPE	624 - 625
IP68	644 - 647
panel supports: COB	page: 652 - 653

inserts, crimp connections



10A crimp contacts silver and gold plated



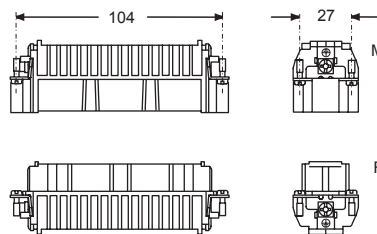
description	part No.	part No.	part No.
without contacts (to be ordered separately)			
female inserts for female contacts	CDF 64		
male inserts for male contacts	CDM 64		
10A female contacts			
0,14-0,37 mm ² AWG 26-22 identification No. 1		CDFA 0.3	CDFD 0.3
0,5 mm ² AWG 20 identification No. 2		CDFA 0.5	CDFD 0.5
0,75 mm ² AWG 18 identification No. ②		CDFA 0.7	CDFD 0.7
1 mm ² AWG 18 identification No. 3		CDFA 1.0	CDFD 1.0
1,5 mm ² AWG 16 identification No. 4		CDFA 1.5	CDFD 1.5
2,5 mm ² AWG 14 identification No. 5		CDFA 2.5	CDFD 2.5
10A male contacts			
0,14-0,37 mm ² AWG 26-22 identification No. 1		CDMA 0.3	CDMD 0.3
0,5 mm ² AWG 20 identification No. 2		CDMA 0.5	CDMD 0.5
0,75 mm ² AWG 18 identification No. ②		CDMA 0.7	CDMD 0.7
1 mm ² AWG 18 identification No. 3		CDMA 1.0	CDMD 1.0
1,5 mm ² AWG 16 identification No. 4		CDMA 1.5	CDMD 1.5
2,5 mm ² AWG 14 identification No. 5		CDMA 2.5	CDMD 2.5

- characteristics according to EN 61984:

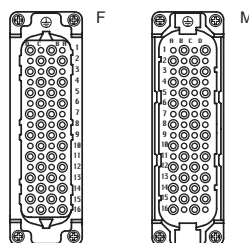
10A 250V 4kV 3
10A 230/400V 4kV 2

- cULus (UL for USA and Canada),
BUREAU VERITAS EAC certified

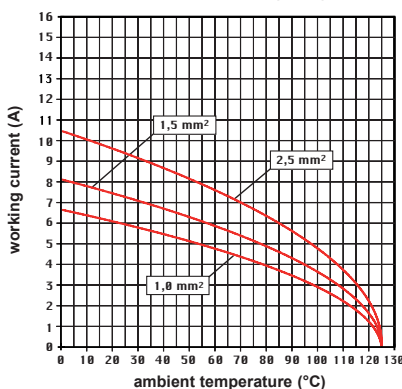
- rated voltage according to UL/CSA: 600V
- insulation resistance: ≥ 10 GΩ
- ambient temperature limit: -40 °C ... +125 °C
- made of self-extinguishing thermoplastic resin UL 94V-0
- mechanical life: ≥ 500 cycles
- contact resistance: ≤ 3 mΩ
- for applications requiring higher voltages, please see the special voltage application section on page 65
- **it is recommended to crimp the contacts with crimping tools homologated by ILME** (please see the crimping tool section 10A contacts, CDF and CDM series on pages 708 - 741)
- for max. current load see the connector inserts derating diagram below; for more information see page 28



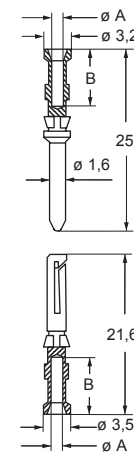
contacts side (front view)



CD 64 poles connector inserts
Maximum current load derating diagram



CR CP coding pin with loss of one contact (page 689)



CDF and CDM contacts

conductor section mm ²	conductor slot Ø A (mm)	conductors stripping length B (mm)
0,14-0,37	0,9	8
0,5	1,1	8
0,75	1,3	8
1,0	1,45	8
1,5	1,8	8
2,5	2,2	6

† for basic or high thickness gold plating, please refer to page 674

CD 80 poles + ⊕ 10A - 250V

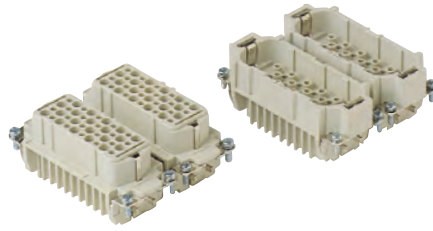
enclosures:
size "77.62"

page:

C-TYPE IP65 or IP66/IP69
W-TYPE for aggressive environments
E-Xtreme® corrosion proof

424 - 429
525
546

inserts, crimp connections



10A crimp contacts silver and gold plated



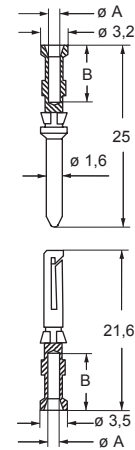
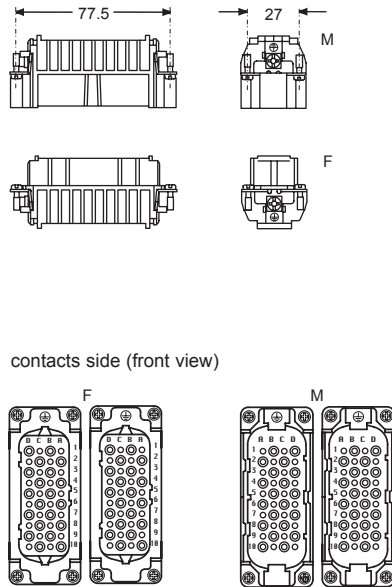
description	part No.	part No.	part No.	part No.
without contacts (to be ordered separately)				
female inserts	CDF 40	CDF 40		
male inserts	CDM 40	CDM 40		
10A female contacts				
0,14-0,37 mm ² AWG 26-22 identification No. 1			CDFA 0.3	CDFD 0.3
0,5 mm ² AWG 20 identification No. 2			CDFA 0.5	CDFD 0.5
0,75 mm ² AWG 18 identification No. ②			CDFA 0.7	CDFD 0.7
1 mm ² AWG 18 identification No. 3			CDFA 1.0	CDFD 1.0
1,5 mm ² AWG 16 identification No. 4			CDFA 1.5	CDFD 1.5
2,5 mm ² AWG 14 identification No. 5			CDFA 2.5	CDFD 2.5
10A male contacts				
0,14-0,37 mm ² AWG 26-22 identification No. 1			CDMA 0.3	CDMD 0.3
0,5 mm ² AWG 20 identification No. 2			CDMA 0.5	CDMD 0.5
0,75 mm ² AWG 18 identification No. ②			CDMA 0.7	CDMD 0.7
1 mm ² AWG 18 identification No. 3			CDMA 1.0	CDMD 1.0
1,5 mm ² AWG 16 identification No. 4			CDMA 1.5	CDMD 1.5
2,5 mm ² AWG 14 identification No. 5			CDMA 2.5	CDMD 2.5

- characteristics according to EN 61984:

10A 250V 4kV 3
10A 230/400V 4kV 2

- cULus (UL for USA and Canada),
BUREAU VERITAS EAC certified

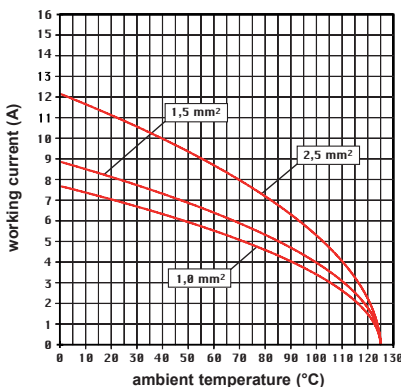
- rated voltage according to UL/CSA: 600V
- insulation resistance: ≥ 10 GΩ
- ambient temperature limit: -40 °C ... +125 °C
- made of self-extinguishing thermoplastic resin UL 94V-0
- mechanical life: ≥ 500 cycles
- contact resistance: ≤ 3 mΩ
- for applications requiring higher voltages, please see the special voltage application section on page 65
- it is recommended to crimp the contacts with crimping tools homologated by ILME (please see the crimping tool section 10A contacts, CDF and CDM series on pages 708 - 741)
- for max. current load see the connector inserts derating diagram below; for more information see page 28



CDF and CDM contacts

conductor section mm ²	conductor slot ø A (mm)	conductors stripping length B (mm)
0,14-0,37	0,9	8
0,5	1,1	8
0,75	1,3	8
1,0	1,45	8
1,5	1,8	8
2,5	2,2	6

CD 80 poles connector inserts
Maximum current load derating diagram



CR CP coding pin
with loss of one contact
(page 689)



+ for basic or high thickness gold plating, please refer to page 674

CD 128 poles + ⊕ 10A - 250V

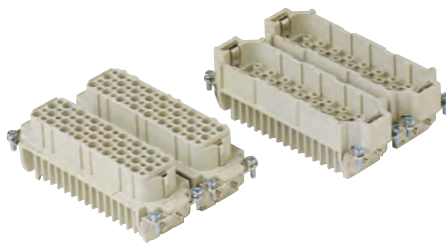
enclosures:
size "104.62"

page:

C-TYPE IP65 or IP66/IP69
W-TYPE for aggressive environments
E-Xtreme® corrosion proof

430
526
547

inserts, crimp connections



10A crimp contacts silver and gold plated



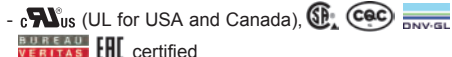
description	part No.	part No.	part No.	part No.
without contacts (to be ordered separately)				
female inserts	CDF 64	CDF 64		
male inserts	CDM 64	CDM 64		
10A female contacts				
0,14-0,37 mm ² AWG 26-22 identification No. 1			C DFA 0.3	C DFD 0.3
0,5 mm ² AWG 20 identification No. 2			C DFA 0.5	C DFD 0.5
0,75 mm ² AWG 18 identification No. ②			C DFA 0.7	C DFD 0.7
1 mm ² AWG 18 identification No. 3			C DFA 1.0	C DFD 1.0
1,5 mm ² AWG 16 identification No. 4			C DFA 1.5	C DFD 1.5
2,5 mm ² AWG 14 identification No. 5			C DFA 2.5	C DFD 2.5
10A male contacts				
0,14-0,37 mm ² AWG 26-22 identification No. 1			C DMA 0.3	C DMD 0.3
0,5 mm ² AWG 20 identification No. 2			C DMA 0.5	C DMD 0.5
0,75 mm ² AWG 18 identification No. ②			C DMA 0.7	C DMD 0.7
1 mm ² AWG 18 identification No. 3			C DMA 1.0	C DMD 1.0
1,5 mm ² AWG 16 identification No. 4			C DMA 1.5	C DMD 1.5
2,5 mm ² AWG 14 identification No. 5			C DMA 2.5	C DMD 2.5

silver plated

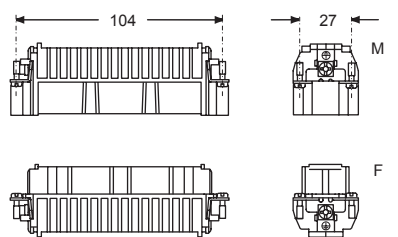
gold plated+

- characteristics according to EN 61984:

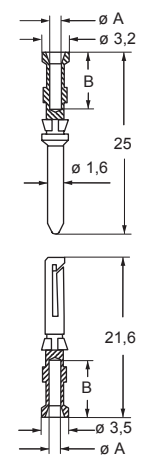
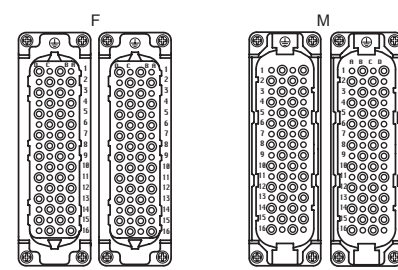
10A 250V 4kV 3
10A 230/400V 4kV 2



- rated voltage according to UL/CSA: 600V
- insulation resistance: ≥ 10 GΩ
- ambient temperature limit: -40 °C ... +125 °C
- made of self-extinguishing thermoplastic resin UL 94V-0
- mechanical life: ≥ 500 cycles
- contact resistance: ≤ 3 mΩ
- for applications requiring higher voltages, please see the special voltage application section on page 65
- **it is recommended to crimp the contacts with crimping tools homologated by ILME** (please see the crimping tool section 10A contacts, CDF and CDM series on pages 708 - 741)
- for max. current load see the connector inserts derating diagram below; for more information see page 28



contacts side (front view)

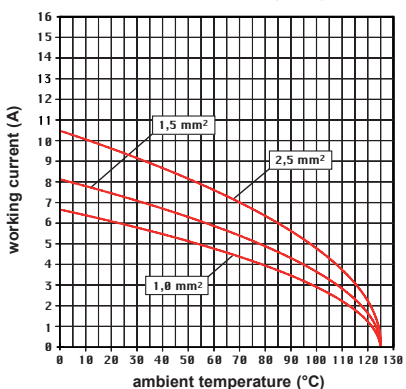


CDF and CDM contacts

conductor section mm ²	conductor slot ø A (mm)	conductors stripping length B (mm)
0,14-0,37	0,9	8
0,5	1,1	8
0,75	1,3	8
1,0	1,45	8
1,5	1,8	8
2,5	2,2	6

+ for basic or high thickness gold plating, please refer to page 674

CD 128 poles connector inserts
Maximum current load derating diagram



CR CP coding pin with loss of one contact (page 689)



Special voltages for CDD series

When all the contacts are used, CDD series connector inserts may be used with voltage up to 250V (first column); pollution degree 2, in accordance with the standard EN 61984.

If the number of contacts is reduced and the contacts assigned accordingly, these connectors may be used with higher voltages. This is possible because the decrease in the number of contacts

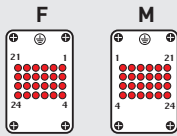
leads to an increase in clearances (insulating distance in air) and creepage distances (insulating distances along the surface).

When the contacts are arranged as shown below, the inserts may be used at rated voltages of 400V (second column) and 500V (third column); pollution degree 2, in accordance with the standard EN 61984.

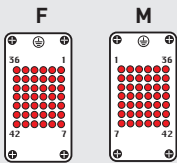
**for use up to 250V
pollution degree 2**

diagrams
contacts side (front view)

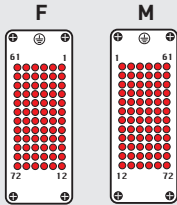
CDD 24 - 24 + ⊕



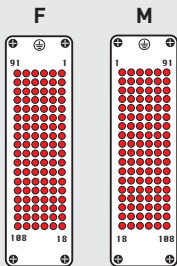
CDD 42 - 42 + ⊕



CDD 72 - 72 + ⊕



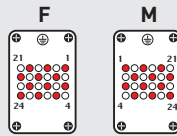
CDD 108 - 108 + ⊕



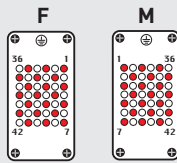
**for use up to 400V
pollution degree 2**

diagrams
contacts side (front view)

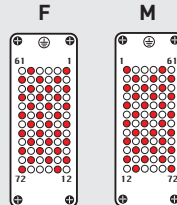
CDD 24 - 12 + ⊕



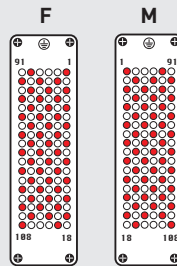
CDD 42 - 21 + ⊕



CDD 72 - 34 + ⊕



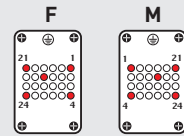
CDD 108 - 52 + ⊕



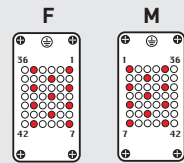
**for use up to 500V
pollution degree 2**

diagrams
contacts side (front view)

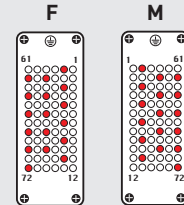
CDD 24 - 5 + ⊕



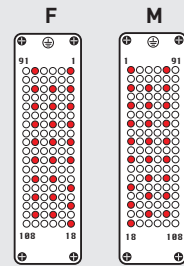
CDD 42 - 11 + ⊕



CDD 72 - 17 + ⊕



CDD 108 - 26 + ⊕



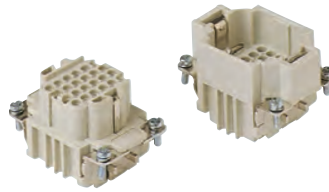
Legend:

- working contact
- without contact
- M = male insert
- F = female insert

CDD 24 poles + ⊕ 10A - 250V

enclosures: size "44.27"	page:
C-TYPE IP65 or IP66/IP69	387 - 392
C7 IP67, single lever	436 - 437
V-TYPE IP65 or IP66/IP69, single lever	444 - 447
BIG hoods	466 - 467
T-TYPE IP65 insulating	480 - 481
T-TYPE / W IP66/IP69 insulating	489
HYGIENIC T-TYPE / H IP66/IP69	501
HYGIENIC T-TYPE / C IP66/IP69, -50 °C	506
W-TYPE for aggressive environments	521
E-Xtreme® corrosion proof	530 - 531, 542, 550 - 551
EMC	578
Central lever	603 - 605
LS-TYPE	618 - 619
IP68	632 - 635
panel supports: COB	page: 652 - 653

inserts, crimp connections



10A crimp contacts silver and gold plated



PCBs interface, see article CIF 2.4 on page 670

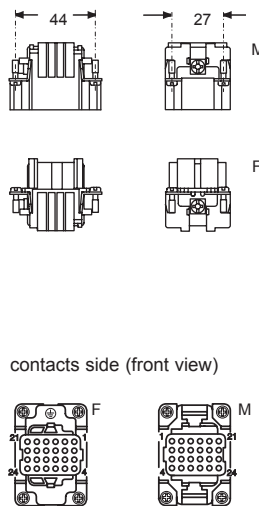
description	part No.	part No.	part No.
without contacts (to be ordered separately)			
female inserts for female contacts	CDDF 24		
male inserts for male contacts	CDDM 24		
10A female contacts			
0,14-0,37 mm ² AWG 26-22 identification No. 1		CDFA 0.3	CDFD 0.3
0,5 mm ² AWG 20 identification No. 2		CDFA 0.5	CDFD 0.5
0,75 mm ² AWG 18 identification No. ②		CDFA 0.7	CDFD 0.7
1 mm ² AWG 18 identification No. 3		CDFA 1.0	CDFD 1.0
1,5 mm ² AWG 16 identification No. 4		CDFA 1.5	CDFD 1.5
2,5 mm ² AWG 14 identification No. 5		CDFA 2.5	CDFD 2.5
10A male contacts			
0,14-0,37 mm ² AWG 26-22 identification No. 1		CDMA 0.3	CDMD 0.3
0,5 mm ² AWG 20 identification No. 2		CDMA 0.5	CDMD 0.5
0,75 mm ² AWG 18 identification No. ②		CDMA 0.7	CDMD 0.7
1 mm ² AWG 18 identification No. 3		CDMA 1.0	CDMD 1.0
1,5 mm ² AWG 16 identification No. 4		CDMA 1.5	CDMD 1.5
2,5 mm ² AWG 14 identification No. 5		CDMA 2.5	CDMD 2.5

- characteristics according to EN 61984:

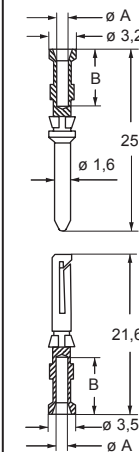
10A 250V 4kV 2

- certified

- rated voltage according to UL/CSA: 600V
- insulation resistance: ≥ 10 GΩ
- ambient temperature limit: -40 °C ... +125 °C
- made of self-extinguishing thermoplastic resin UL 94V-0
- mechanical life: ≥ 500 cycles
- contact resistance: ≤ 3 mΩ
- for applications requiring higher voltages, please see the special voltage application section on page 75
- **it is recommended to crimp the contacts with crimping tools homologated by ILME** (please see the crimping tool section 10A contacts, CDF and CDM series on pages 708 - 741)
- for max. current load see the connector inserts derating diagram below; for more information see page 28



contacts side (front view)

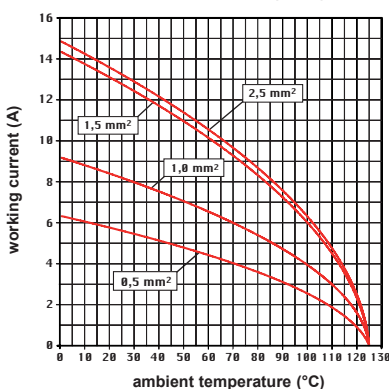


CDF and CDM contacts

conductor section mm ²	conductor slot ø A (mm)	conductors stripping length B (mm)
0,14-0,37	0,9	8
0,5	1,1	8
0,75	1,3	8
1,0	1,45	8
1,5	1,8	8
2,5	2,2	6

† for basic or high thickness gold plating, please refer to page 674

CDD 24 poles connector inserts
Maximum current load derating diagram



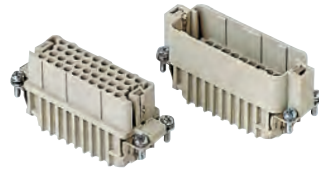
CR CP coding pin with loss of one contact (page 689)



CDD 38 poles + ⊕ 10A - 250V

enclosures: size "66.16"	page:
IL-BRID	378 - 382
CZ7 IP67, single lever	385
W-TYPE for aggressive environments	520
E-Xtreme® corrosion proof	541
EMC	577
panel supports: COB	page: 652 - 653

inserts, crimp connections



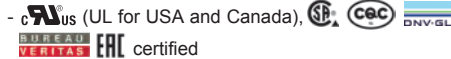
10A crimp contacts silver and gold plated



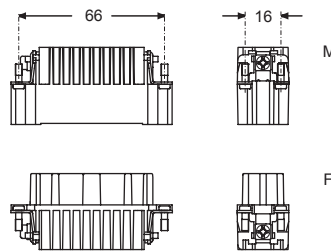
description	part No.	part No.	part No.
without contacts (to be ordered separately)			
female inserts for female contacts	CDDF 38		
male inserts for male contacts	CDDM 38		
10A female contacts			
0,14-0,37 mm ² AWG 26-22 identification No. 1		CDFA 0.3	CDFD 0.3
0,5 mm ² AWG 20 identification No. 2		CDFA 0.5	CDFD 0.5
0,75 mm ² AWG 18 identification No. ②		CDFA 0.7	CDFD 0.7
1 mm ² AWG 18 identification No. 3		CDFA 1.0	CDFD 1.0
1,5 mm ² AWG 16 identification No. 4		CDFA 1.5	CDFD 1.5
2,5 mm ² AWG 14 identification No. 5		CDFA 2.5	CDFD 2.5
10A male contacts			
0,14-0,37 mm ² AWG 26-22 identification No. 1		CDMA 0.3	CDMD 0.3
0,5 mm ² AWG 20 identification No. 2		CDMA 0.5	CDMD 0.5
0,75 mm ² AWG 18 identification No. ②		CDMA 0.7	CDMD 0.7
1 mm ² AWG 18 identification No. 3		CDMA 1.0	CDMD 1.0
1,5 mm ² AWG 16 identification No. 4		CDMA 1.5	CDMD 1.5
2,5 mm ² AWG 14 identification No. 5		CDMA 2.5	CDMD 2.5

- characteristics according to EN 61984:

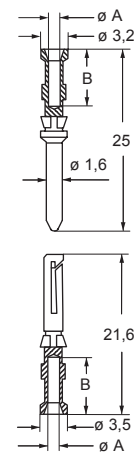
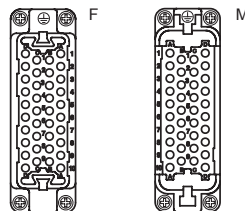
10A 250V 4kV 2



- rated voltage according to UL/CSA: 600V
- insulation resistance: ≥ 10 GΩ
- ambient temperature limit: -40 °C ... +125 °C
- made of self-extinguishing thermoplastic resin UL 94V-0
- mechanical life: ≥ 500 cycles
- contact resistance: ≤ 3 mΩ
- for applications requiring higher voltages, please see the special voltage application section on page 75
- **it is recommended to crimp the contacts with crimping tools homologated by ILME** (please see the crimping tool section 10A contacts, CDF and CDM series on pages 708 - 741)
- for max. current load see the connector inserts derating diagram below; for more information see page 28



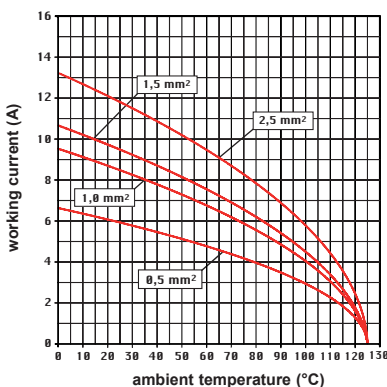
contacts side (front view)



CDF and CDM contacts

conductor section mm ²	conductor slot ø A (mm)	conductors stripping length B (mm)
0,14-0,37	0,9	8
0,5	1,1	8
0,75	1,3	8
1,0	1,45	8
1,5	1,8	8
2,5	2,2	6

CDD 38 poles connector inserts
Maximum current load derating diagram



CR CP coding pin with loss of one contact (page 689)

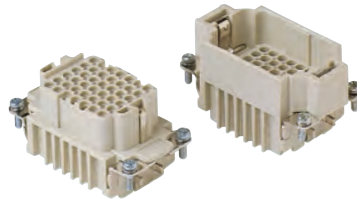


+ for basic or high thickness gold plating, please refer to page 674

CDD 42 poles + ⊕ 10A - 250V

enclosures: size "57.27"	page:
C-TYPE IP65 or IP66/IP69	393 - 401
C7 IP67, two levers	438
V-TYPE IP65 or IP66/IP69, single lever	448 - 453
BIG hoods	468 - 469
T-TYPE IP65 insulating	482 - 483
T-TYPE / W IP66/IP69 insulating	490
HYGIENIC T-TYPE / H IP66/IP69	502
HYGIENIC T-TYPE / C IP66/IP69, -50 °C	507
W-TYPE for aggressive environments	522
E-Xtreme® corrosion proof	532 - 533, 543, 552 - 553
EMC	579
Central lever	606 - 608
LS-TYPE	620 - 621
IP68	636 - 639
panel supports:	page:
COB	652 - 653

inserts, crimp connections



10A crimp contacts
silver and gold plated



PCBs interface, see article CIF 2.4 on page 670

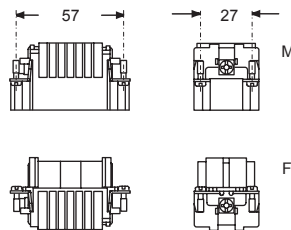
description	part No.	part No.	part No.
without contacts (to be ordered separately)			
female inserts for female contacts	CDDF 42		
male inserts for male contacts	CDDM 42		
10A female contacts			
0,14-0,37 mm ² AWG 26-22 identification No. 1		CDFA 0.3	CDFD 0.3
0,5 mm ² AWG 20 identification No. 2		CDFA 0.5	CDFD 0.5
0,75 mm ² AWG 18 identification No. ②		CDFA 0.7	CDFD 0.7
1 mm ² AWG 18 identification No. 3		CDFA 1.0	CDFD 1.0
1,5 mm ² AWG 16 identification No. 4		CDFA 1.5	CDFD 1.5
2,5 mm ² AWG 14 identification No. 5		CDFA 2.5	CDFD 2.5
10A male contacts			
0,14-0,37 mm ² AWG 26-22 identification No. 1		CDMA 0.3	CDMD 0.3
0,5 mm ² AWG 20 identification No. 2		CDMA 0.5	CDMD 0.5
0,75 mm ² AWG 18 identification No. ②		CDMA 0.7	CDMD 0.7
1 mm ² AWG 18 identification No. 3		CDMA 1.0	CDMD 1.0
1,5 mm ² AWG 16 identification No. 4		CDMA 1.5	CDMD 1.5
2,5 mm ² AWG 14 identification No. 5		CDMA 2.5	CDMD 2.5

- characteristics according to EN 61984:

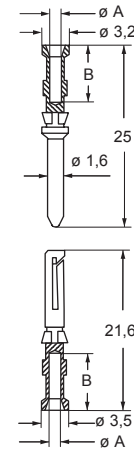
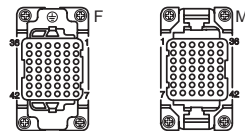
10A 250V 4kV 2

- certified

- rated voltage according to UL/CSA: 600V
- insulation resistance: ≥ 10 GΩ
- ambient temperature limit: -40 °C ... +125 °C
- made of self-extinguishing thermoplastic resin UL 94V-0
- mechanical life: ≥ 500 cycles
- contact resistance: ≤ 3 mΩ
- for applications requiring higher voltages, please see the special voltage application section on page 75
- **it is recommended to crimp the contacts with crimping tools homologated by ILME** (please see the crimping tool section 10A contacts, CDF and CDM series on pages 708 - 741)
- for max. current load see the connector inserts derating diagram below; for more information see page 28



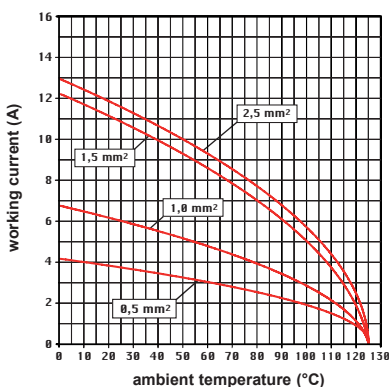
contacts side (front view)



CDF and CDM contacts

conductor section mm ²	conductor slot Ø A (mm)	conductors stripping length B (mm)
0,14-0,37	0,9	8
0,5	1,1	8
0,75	1,3	8
1,0	1,45	8
1,5	1,8	8
2,5	2,2	6

CDD 42 poles connector inserts
Maximum current load derating diagram



CR CP coding pin with loss of one contact (page 689)

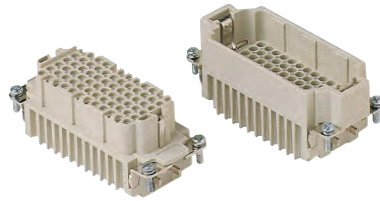


† for basic or high thickness gold plating, please refer to page 674

CDD 72 poles + ⊕ 10A - 250V

enclosures: size "77.27"	page:
C-TYPE IP65 or IP66/IP69	402 - 411
C7 IP67, two levers	439 - 440
V-TYPE IP65 or IP66/IP69, single lever	454 - 458
BIG hoods	470 - 471
T-TYPE IP65 insulating	484 - 485
T-TYPE / W IP66/IP69 insulating	491
HYGIENIC T-TYPE / H IP66/IP69	503
HYGIENIC T-TYPE / C IP66/IP69, -50 °C	508
W-TYPE for aggressive environments	523
E-Xtreme® corrosion proof	534 - 535, 544, 554 - 555
EMC	580
Central lever	609 - 611
LS-TYPE	622 - 623
IP68	640 - 643
panel supports: COB	page: 652 - 653

inserts, crimp connections



10A crimp contacts silver and gold plated

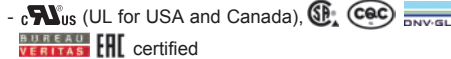


PCBs interface, see article CIF 2.4 on page 670

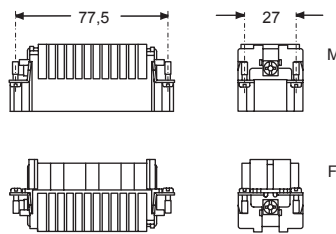
description	part No.	part No.	part No.
without contacts (to be ordered separately)			
female inserts for female contacts	CDDF 72		
male inserts for male contacts	CDDM 72		
10A female contacts			
0,14-0,37 mm ² AWG 26-22 identification No. 1		CDFA 0.3	CDFD 0.3
0,5 mm ² AWG 20 identification No. 2		CDFA 0.5	CDFD 0.5
0,75 mm ² AWG 18 identification No. ②		CDFA 0.7	CDFD 0.7
1 mm ² AWG 18 identification No. 3		CDFA 1.0	CDFD 1.0
1,5 mm ² AWG 16 identification No. 4		CDFA 1.5	CDFD 1.5
2,5 mm ² AWG 14 identification No. 5		CDFA 2.5	CDFD 2.5
10A male contacts			
0,14-0,37 mm ² AWG 26-22 identification No. 1		CDMA 0.3	CDMD 0.3
0,5 mm ² AWG 20 identification No. 2		CDMA 0.5	CDMD 0.5
0,75 mm ² AWG 18 identification No. ②		CDMA 0.7	CDMD 0.7
1 mm ² AWG 18 identification No. 3		CDMA 1.0	CDMD 1.0
1,5 mm ² AWG 16 identification No. 4		CDMA 1.5	CDMD 1.5
2,5 mm ² AWG 14 identification No. 5		CDMA 2.5	CDMD 2.5

- characteristics according to EN 61984:

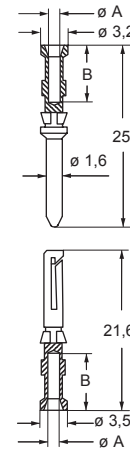
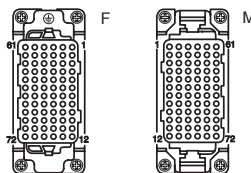
10A 250V 4kV 2



- rated voltage according to UL/CSA: 600V
- insulation resistance: ≥ 10 GΩ
- ambient temperature limit: -40 °C ... +125 °C
- made of self-extinguishing thermoplastic resin UL 94V-0
- mechanical life: ≥ 500 cycles
- contact resistance: ≤ 3 mΩ
- for applications requiring higher voltages, please see the special voltage application section on page 75
- **it is recommended to crimp the contacts with crimping tools homologated by ILME** (please see the crimping tool section 10A contacts, CDF and CDM series on pages 708 - 741)
- for max. current load see the connector inserts derating diagram below; for more information see page 28



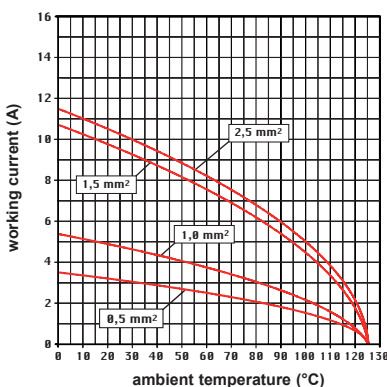
contacts side (front view)



CDF and CDM contacts

conductor section mm ²	conductor slot ø A (mm)	conductors stripping length B (mm)
0,14-0,37	0,9	8
0,5	1,1	8
0,75	1,3	8
1,0	1,45	8
1,5	1,8	8
2,5	2,2	6

CDD 72 poles connector inserts
Maximum current load derating diagram



CR CP coding pin with loss of one contact (page 689)



+ for basic or high thickness gold plating, please refer to page 674

CDD 76 poles + ⊕ 10A - 250V

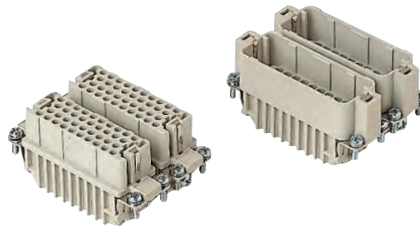
enclosures:
size "66.40"

page:

C-TYPE IP65 or IP66/IP69
W-TYPE for aggressive environments

431 - 434
527

inserts, crimp connections



10A crimp contacts silver and gold plated



description	part No.	part No.	part No.	part No.
without contacts (to be ordered separately)				
female inserts	CDDF 38	CDDF 38		
male inserts	CDDM 38	CDDM 38		
10A female contacts				
0,14-0,37 mm ² AWG 26-22 identification No. 1			CDFA 0.3	CDFD 0.3
0,5 mm ² AWG 20 identification No. 2			CDFA 0.5	CDFD 0.5
0,75 mm ² AWG 18 identification No. ②			CDFA 0.7	CDFD 0.7
1 mm ² AWG 18 identification No. 3			CDFA 1.0	CDFD 1.0
1,5 mm ² AWG 16 identification No. 4			CDFA 1.5	CDFD 1.5
2,5 mm ² AWG 14 identification No. 5			CDFA 2.5	CDFD 2.5
10A male contacts				
0,14-0,37 mm ² AWG 26-22 identification No. 1			CDMA 0.3	CDMD 0.3
0,5 mm ² AWG 20 identification No. 2			CDMA 0.5	CDMD 0.5
0,75 mm ² AWG 18 identification No. ②			CDMA 0.7	CDMD 0.7
1 mm ² AWG 18 identification No. 3			CDMA 1.0	CDMD 1.0
1,5 mm ² AWG 16 identification No. 4			CDMA 1.5	CDMD 1.5
2,5 mm ² AWG 14 identification No. 5			CDMA 2.5	CDMD 2.5

silver plated

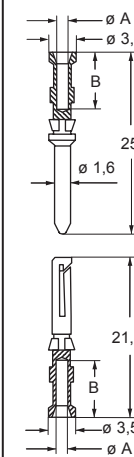
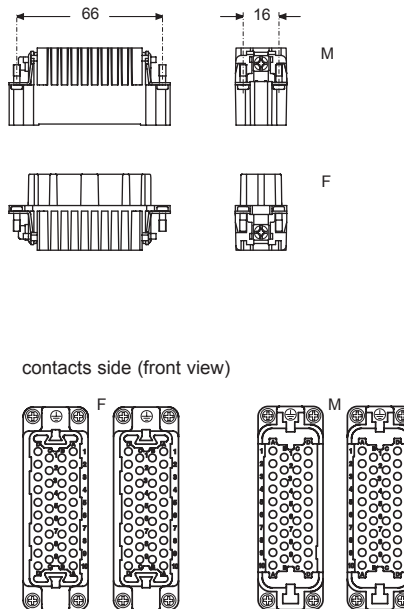
gold plated+

- characteristics according to EN 61984:

10A 250V 4kV 2

- certified

- rated voltage according to UL/CSA: 600V
- insulation resistance: ≥ 10 GΩ
- ambient temperature limit: -40 °C ... +125 °C
- made of self-extinguishing thermoplastic resin UL 94V-0
- mechanical life: ≥ 500 cycles
- contact resistance: ≤ 3 mΩ
- for applications requiring higher voltages, please see the special voltage application section on page 75
- **it is recommended to crimp the contacts with crimping tools homologated by ILME** (please see the crimping tool section 10A contacts, CDF and CDM series on pages 708 - 741)
- for max. current load see the connector inserts derating diagram below; for more information see page 28

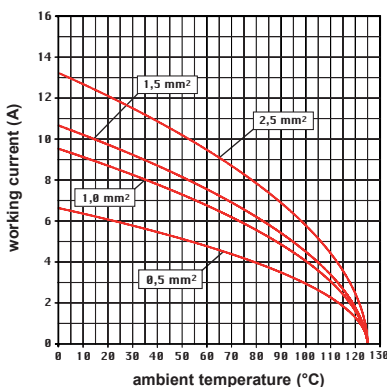


CDF and CDM contacts

conductor section mm ²	conductor slot ø A (mm)	conductors stripping length B (mm)
0,14-0,37	0,9	8
0,5	1,1	8
0,75	1,3	8
1,0	1,45	8
1,5	1,8	8
2,5	2,2	6

+ for basic or high thickness gold plating, please refer to page 674

CDD 76 poles connector inserts
Maximum current load derating diagram



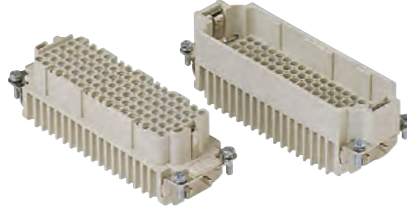
CR CP coding pin with loss of one contact (page 689)



CDD 108 poles + ⊕ 10A - 250V

enclosures: size "104.27"	page:
C-TYPE IP65 or IP66/IP69	412 - 423
C7 IP67, two levers	441 - 442
V-TYPE IP65 or IP66/IP69, single lever	459 - 463
BIG hoods	472 - 473
T-TYPE IP65 insulating	486 - 487
T-TYPE / W IP66/IP69 insulating	492
HYGIENIC T-TYPE / H IP66/IP69	504
HYGIENIC T-TYPE / C IP66/IP69, -50 °C	509
W-TYPE for aggressive environments	524
E-Xtreme® corrosion proof	536 - 537, 545, 556 - 557
EMC	581
Central lever	612 - 614
LS-TYPE	624 - 625
IP68	644 - 647
panel supports: COB	page: 652 - 653

inserts, crimp connections



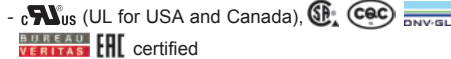
10A crimp contacts
silver and gold plated



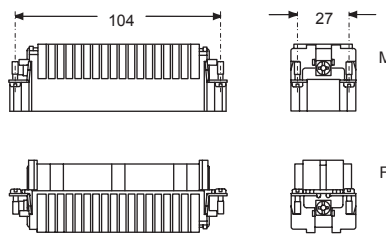
description	part No.	part No.	part No.
without contacts (to be ordered separately)			
female inserts for female contacts	CDDF 108		
male inserts for male contacts	CDDM 108		
10A female contacts			
0,14-0,37 mm ² AWG 26-22 identification No. 1		CDFA 0.3	CDFD 0.3
0,5 mm ² AWG 20 identification No. 2		CDFA 0.5	CDFD 0.5
0,75 mm ² AWG 18 identification No. ②		CDFA 0.7	CDFD 0.7
1 mm ² AWG 18 identification No. 3		CDFA 1.0	CDFD 1.0
1,5 mm ² AWG 16 identification No. 4		CDFA 1.5	CDFD 1.5
2,5 mm ² AWG 14 identification No. 5		CDFA 2.5	CDFD 2.5
10A male contacts			
0,14-0,37 mm ² AWG 26-22 identification No. 1		CDMA 0.3	CDMD 0.3
0,5 mm ² AWG 20 identification No. 2		CDMA 0.5	CDMD 0.5
0,75 mm ² AWG 18 identification No. ②		CDMA 0.7	CDMD 0.7
1 mm ² AWG 18 identification No. 3		CDMA 1.0	CDMD 1.0
1,5 mm ² AWG 16 identification No. 4		CDMA 1.5	CDMD 1.5
2,5 mm ² AWG 14 identification No. 5		CDMA 2.5	CDMD 2.5

- characteristics according to EN 61984:

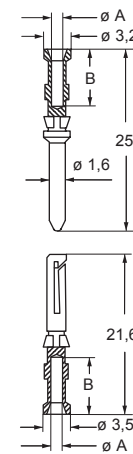
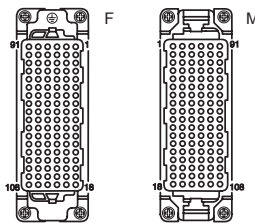
10A 250V 4kV 2



- rated voltage according to UL/CSA: 600V
- insulation resistance: ≥ 10 GΩ
- ambient temperature limit: -40 °C ... +125 °C
- made of self-extinguishing thermoplastic resin UL 94V-0
- mechanical life: ≥ 500 cycles
- contact resistance: ≤ 3 mΩ
- for applications requiring higher voltages, please see the special voltage application section on page 75
- **it is recommended to crimp the contacts with crimping tools homologated by ILME** (please see the crimping tool section 10A contacts, CDF and CDM series on pages 708 - 741)
- for max. current load see the connector inserts derating diagram below; for more information see page 28



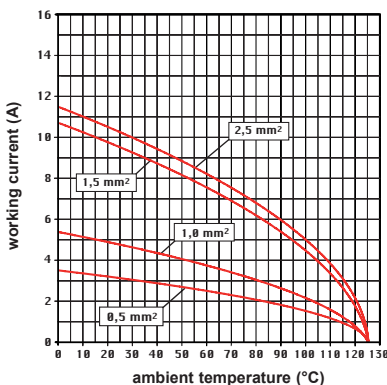
contacts side (front view)



CDF and CDM contacts

conductor section mm ²	conductor slot ø A (mm)	conductors stripping length B (mm)
0,14-0,37	0,9	8
0,5	1,1	8
0,75	1,3	8
1,0	1,45	8
1,5	1,8	8
2,5	2,2	6

CDD 108 poles connector inserts
Maximum current load derating diagram



CR CP coding pin with loss of one contact (page 689)



+ for basic or high thickness gold plating, please refer to page 674

CDD 144 poles + ⊕ 10A - 250V

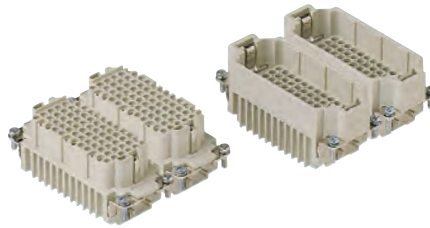
enclosures:
size "77.62"

page:

C-TYPE IP65 or IP66/IP69
W-TYPE for aggressive environments
E-Xtreme® corrosion proof

424 - 429
525
546

inserts, crimp connections



10A crimp contacts silver and gold plated



PCBs interface, see article CIF 2.4 on page 670

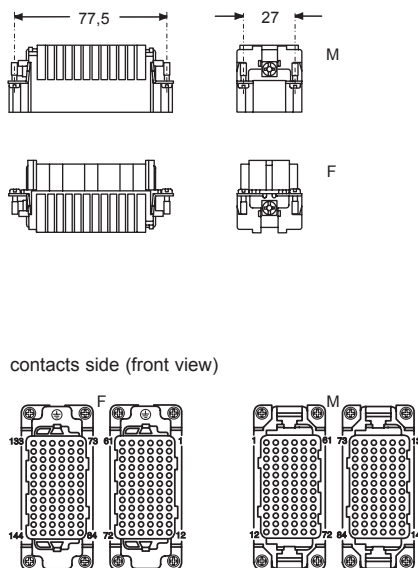
description	part No.	part No.	part No.	part No.
without contacts (to be ordered separately)				
female inserts, No. (1-72) and (73-144)	CDDF 72	CDDF 72 N		
male inserts, No. (1-72) and (73-144)	CDDM 72	CDDM 72 N		
10A female contacts				
0,14-0,37 mm ² AWG 26-22 identification No. 1			CDFA 0.3	CDFD 0.3
0,5 mm ² AWG 20 identification No. 2			CDFA 0.5	CDFD 0.5
0,75 mm ² AWG 18 identification No. ②			CDFA 0.7	CDFD 0.7
1 mm ² AWG 18 identification No. 3			CDFA 1.0	CDFD 1.0
1,5 mm ² AWG 16 identification No. 4			CDFA 1.5	CDFD 1.5
2,5 mm ² AWG 14 identification No. 5			CDFA 2.5	CDFD 2.5
10A male contacts				
0,14-0,37 mm ² AWG 26-22 identification No. 1			CDMA 0.3	CDMD 0.3
0,5 mm ² AWG 20 identification No. 2			CDMA 0.5	CDMD 0.5
0,75 mm ² AWG 18 identification No. ②			CDMA 0.7	CDMD 0.7
1 mm ² AWG 18 identification No. 3			CDMA 1.0	CDMD 1.0
1,5 mm ² AWG 16 identification No. 4			CDMA 1.5	CDMD 1.5
2,5 mm ² AWG 14 identification No. 5			CDMA 2.5	CDMD 2.5

- characteristics according to EN 61984:

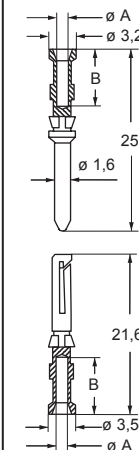
10A 250V 4kV 2

- certified

- rated voltage according to UL/CSA: 600V
- insulation resistance: ≥ 10 GΩ
- ambient temperature limit: -40 °C ... +125 °C
- made of self-extinguishing thermoplastic resin UL 94V-0
- mechanical life: ≥ 500 cycles
- contact resistance: ≤ 3 mΩ
- for applications requiring higher voltages, please see the special voltage application section on page 75
- **it is recommended to crimp the contacts with crimping tools homologated by ILME** (please see the crimping tool section 10A contacts, CDF and CDM series on pages 708 - 741)
- for max. current load see the connector inserts derating diagram below; for more information see page 28



contacts side (front view)

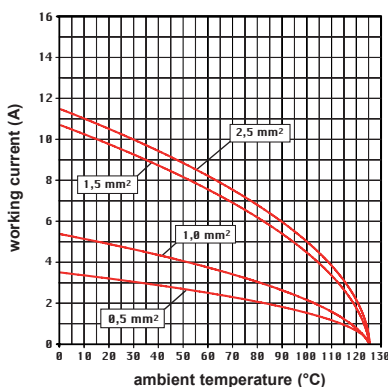


CDF and CDM contacts

conductor section mm ²	conductor slot $\varnothing A$ (mm)	conductors stripping length B (mm)
0,14-0,37	0,9	8
0,5	1,1	8
0,75	1,3	8
1,0	1,45	8
1,5	1,8	8
2,5	2,2	6

† for basic or high thickness gold plating, please refer to page 674

CDD 144 poles connector inserts Maximum current load derating diagram



CR CP coding pin with loss of one contact (page 689)



CDD 216 poles + ⊕ 10A - 250V

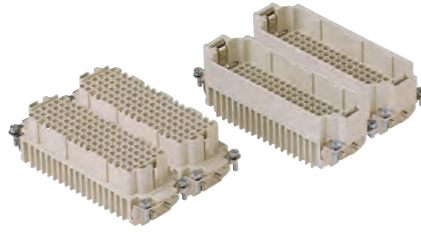
enclosures:
size "104.62"

page:

C-TYPE IP65 or IP66/IP69
W-TYPE for aggressive environments
E-Xtreme® corrosion proof

430
526
547

inserts, crimp connections



10A crimp contacts silver and gold plated



PCBs interface, see article CIF 2.4 on page 670

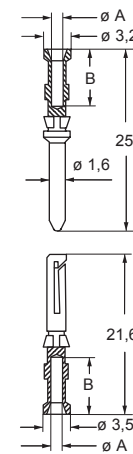
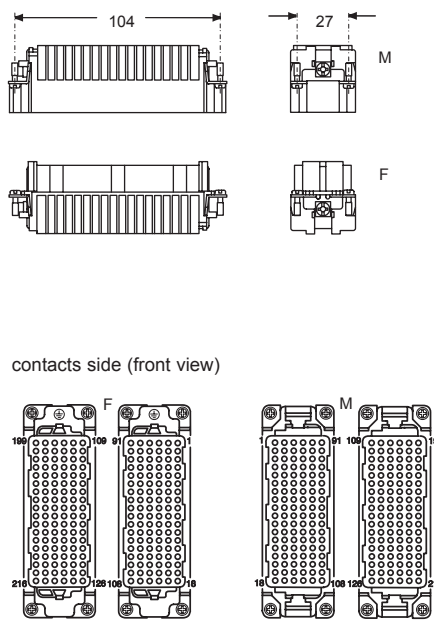
description	part No.	part No.	part No.	part No.
without contacts (to be ordered separately)				
female inserts, No. (1-108) and (109-216)	CDDF 108	CDDF 108 N		
male inserts, No. (1-108) and (109-216)	CDDM 108	CDDM 108 N		
10A female contacts				
0,14-0,37 mm ² AWG 26-22 identification No. 1			CDFA 0.3	CDFD 0.3
0,5 mm ² AWG 20 identification No. 2			CDFA 0.5	CDFD 0.5
0,75 mm ² AWG 18 identification No. ②			CDFA 0.7	CDFD 0.7
1 mm ² AWG 18 identification No. 3			CDFA 1.0	CDFD 1.0
1,5 mm ² AWG 16 identification No. 4			CDFA 1.5	CDFD 1.5
2,5 mm ² AWG 14 identification No. 5			CDFA 2.5	CDFD 2.5
10A male contacts				
0,14-0,37 mm ² AWG 26-22 identification No. 1			CDMA 0.3	CDMD 0.3
0,5 mm ² AWG 20 identification No. 2			CDMA 0.5	CDMD 0.5
0,75 mm ² AWG 18 identification No. ②			CDMA 0.7	CDMD 0.7
1 mm ² AWG 18 identification No. 3			CDMA 1.0	CDMD 1.0
1,5 mm ² AWG 16 identification No. 4			CDMA 1.5	CDMD 1.5
2,5 mm ² AWG 14 identification No. 5			CDMA 2.5	CDMD 2.5

- characteristics according to EN 61984:

10A 250V 4kV 2

- (UL for USA and Canada), certified

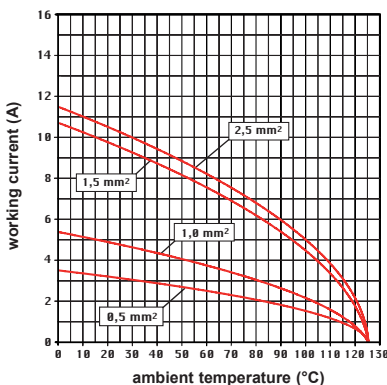
- rated voltage according to UL/CSA: 600V
- insulation resistance: ≥ 10 GΩ
- ambient temperature limit: -40 °C ... +125 °C
- made of self-extinguishing thermoplastic resin UL 94V-0
- mechanical life: ≥ 500 cycles
- contact resistance: ≤ 3 mΩ
- for applications requiring higher voltages, please see the special voltage application section on page 75
- **it is recommended to crimp the contacts with crimping tools homologated by ILME** (please see the crimping tool section 10A contacts, CDF and CDM series on pages 708 - 741)
- for max. current load see the connector inserts derating diagram below; for more information see page 28



CDF and CDM contacts

conductor section mm ²	conductor slot ϕA (mm)	conductors stripping length B (mm)
0,14-0,37	0,9	8
0,5	1,1	8
0,75	1,3	8
1,0	1,45	8
1,5	1,8	8
2,5	2,2	6

**CDD 216 poles connector inserts
Maximum current load derating diagram**



CR CP coding pin with loss of one contact (page 689)



+ for basic or high thickness gold plating, please refer to page 674

CDSH-SQUICH® series

High density without tools (spring connection contacts)

The CDSH-SQUICH® series (with spring and actuator button) are the logical **evolution of the CDS series**.

The continuous demand for a greater number of poles and smaller dimensions has led to the design and manufacture of the new CDSH series, which offers single connectors with a **maximum number of 84 poles** that occupy the **same space of standard connectors** with screw/spring connection.

Each of the spring terminals has an actuator button, suitably shaped and incorporated in the cavity. When this button is pushed, it triggers the closure of the spring device of the corresponding terminal, safely and reliably connecting the conductor to its respective electric contact in the connector.

The actuator buttons are supplied raised, in the "open terminal" position and are **easily distinguishable by the orange colour** which makes them stand out from the insulating body of the connector.

The advantage of this exclusive solution is that **the actuators disappear completely within the body of the connector**, making it easy to identify terminals not yet closed and **eliminating possible obstacles** to the movement of the conductors during installation and maintenance.

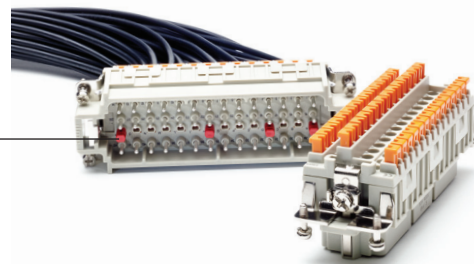
SQUICH® technology requires no tools **to activate the terminal and a simple operation is all you need to make the connection**. Refer to SQUICH® Connection operating principles on page 24.

It is possible to insert in the mating area the **CR CDS plastic coding pin** that enables the polarisation of inserts in a wide range of combinations. This means that it is possible to install side by side identical connectors with different functions.



The CR CDS coding pins **can also be used in combination with CR 20 / CRM / CRF / CR 72 metal pins** instead of insert fixing screws in order to increase the number of possible combinations. Each position of the coding pin used on the female insert must correspond to an unused position on the male insert.

The required number of coding pins, depending on the size of connectors, and the maximum number of possible codings is shown in the table 1.



SUM UP

- ☑ **Greater pole density as compared to existing connector with screw terminals.**
SAVE SPACE +70%
- ☑ **Reduced wiring time.**
SAVE TIME -50%

STANDARD	CDSH - HIGH DENSITY	
16A	10A	
06 poles	09 poles	+50%
10 poles	18 poles	+80%
16 poles	27 poles	+70%
24 poles	42 poles	+75%
32 poles	54 poles	+70%
48 poles	84 poles	+75%

- ☑ **Wiring tool is not necessary**
- ☑ **Quick identification of wired and non-wired terminals**
- ☑ **Terminals already open and ready for conductor clamping**
- ☑ **Option to use wires up to 2,5 mm²**
- ☑ **Built-in silver plated contacts**
- ☑ **Excellent fastening solution**
- ☑ **Great resistance to strong vibration**

Q CDSH series can be used with the whole range of ILME enclosures

Table 1. CDSH series - Coding with CR CDS pins

Size of connectors	Slots for coding pins (M) = male insert (F) = female insert	Required coding pins for each coupling	Possible codings
9P + ⊕	3 (M) + 3 (F)	3 2 (M) + 1 (F)	3
18P + ⊕	6 (M) + 6 (F)	6 3 (M) + 3 (F)	20
27P + ⊕	9 (M) + 9 (F)	9 5 (M) + 4 (F)	126
42P + ⊕	14 (M) + 14 (F)	14 7 (M) + 7 (F)	3.432

CDSH-SQUICH® series

TECHNICAL FEATURES

Insert series		CDSH-SQUICH®
No. of poles ¹⁾	Main contacts + ⊕	9, 18, 27, 42, (54), (84)
	auxiliary contacts	—
Rated current ²⁾		10A
EN IEC 61984	rated voltage	400V
	rated impulse voltage	6kV
	pollution degree	3
EN IEC 61984	rated voltage	400V / 690V
	rated impulse voltage	6kV
	pollution degree	2
Contact resistance		≤ 3 mΩ
Insulation resistance		≥ 10 GΩ
Ambient temperature limit (°C)	min	-40
	max	+125
Degree of protection	with enclosures (according to type)	IP65, IP66/IP69, IP66/IP67/IP69, IP66/IP68/IP69
	without enclosures (in mated condition)	IP20 (IPXXB)
Conductor connections		spring type with actuator button
Conductor cross-sectional area	mm ²	0,14 - 2,5 (for wires with crimped ferrule, usable section: up to 1,5 mm ²)
	AWG	26 - 14 (AWG 16 with crimped ferrule) 26 - 16 prepared with crimped ferrule
Mechanical endurance (mating cycles)		≥ 500







1) Polarities shown in brackets may be achieved by using two inserts in their own double sized housings.

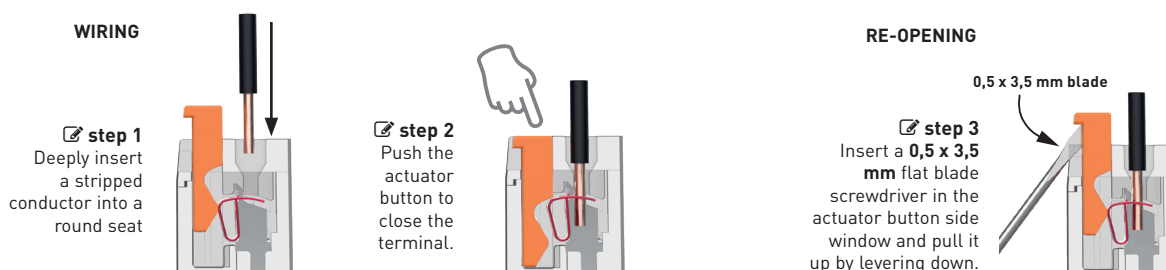
2) Please check the insert load curves to establish the actual maximum operating current according to the ambient temperature.

SQUICH® Connection technology

In the layout below the wires are connected to the socket and plug insert contacts by means of a spring terminal with actuator button.

This type of connection offers the following advantages:

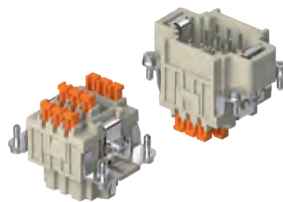
-  no special wire preparation (other than stripping);
-  it offers an excellent fastening solution and a great resistance to strong vibrations;
-  it allows the use of solid and flexible wires with cross-sections between 0,14 and 2,5 mm² (AWG 26 - 14);
-  for wires with crimped ferrule, usable section: to 1,5 mm² (AWG 16);
-  a screwdriver with a 0,5 x 3,5 mm blade is the only tool required to remove the wire from the contact;
-  the profile of the actuator button allows the section of a test probe.



CDSH-SQUICH® 9 poles + ⊕ 10A - 400V

enclosures: size "44.27"	page:
C-TYPE IP65 or IP66/IP69	387 - 392
C7 IP67, single lever	436 - 437
V-TYPE IP65 or IP66/IP69, single lever	444 - 447
BIG hoods	466 - 467
T-TYPE IP65 insulating	480 - 481
T-TYPE / W IP66/IP69 insulating	489
HYGIENIC T-TYPE / H IP66/IP69	501
HYGIENIC T-TYPE / C IP66/IP69, -50 °C	506
W-TYPE for aggressive environments	521
E-Xtreme® corrosion proof	530 - 531, 542, 550 - 551
EMC	578
Central lever	603 - 605
LS-TYPE	618 - 619
IP68	632 - 635
panel supports: COB	page: 652 - 653

inserts, spring terminal connections without tools



coding pins



description	part No.	part No.
-------------	----------	----------

spring terminals with actuator button
female inserts with female contacts
male inserts with male contacts

CDSHF 09
CDSHM 09

plastic coding pins

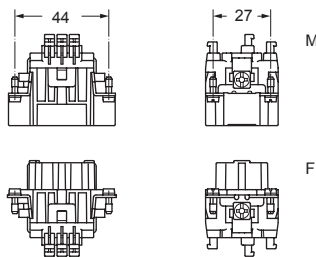
CR CDS

- characteristics according to EN 61984:

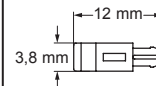
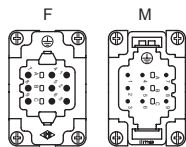
10A 400V 6kV 3
10A 400V/690V 6kV 2

- certified

- rated voltage according to UL/CSA: 600V
- insulation resistance: ≥ 10 GΩ
- ambient temperature limit: -40 °C ... +125 °C
- made of self-extinguishing thermoplastic resin UL 94V-0
- mechanical life: ≥ 500 cycles
- contact resistance: ≤ 3 mΩ
- for max. current load see the connector inserts derating diagram below; for more information see page 28



contacts side (front view)

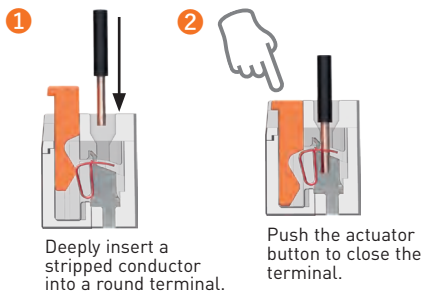


CDSH series - Coding with CR CDS pins

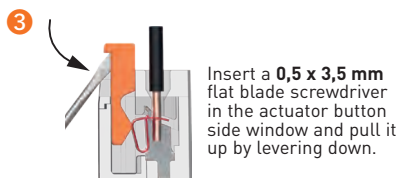
Size of connectors	Slots for coding pins (M) = male insert (F) = female insert	Required coding pins for each coupling	Possible codings
9P + ⊕	3 (M) + 3 (F)	3 2 (M) + 1 (F)	3

- inserts for conductors cross-sectional areas: 0,14 - 2,5 mm² - AWG 26 - 14
- for wires with crimped ferrule, usable section: up to 1,5 mm² (AWG 16)
- conductors stripping length: 9...11 mm

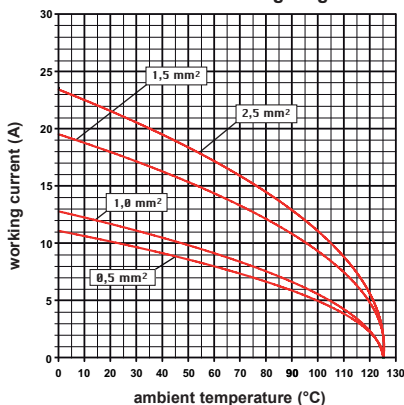
SQUICH®-spring connection technology WIRING



RE-OPENING



CDSH 09 poles connector inserts
Maximum current load derating diagram

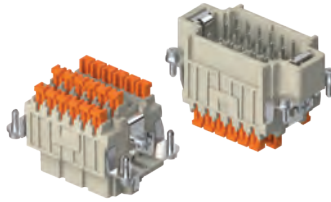


CDSH-SQUICH®

CDSH-SQUICH® 18 poles + ⊕ 10A - 400V

enclosures: size "57.27"	page:
C-TYPE IP65 or IP66/IP69	393 - 401
C7 IP67, two levers	438
V-TYPE IP65 or IP66/IP69, single lever	448 - 453
BIG hoods	468 - 469
T-TYPE IP65 insulating	482 - 483
T-TYPE / W IP66/IP69 insulating	490
HYGIENIC T-TYPE / H IP66/IP69	502
HYGIENIC T-TYPE / C IP66/IP69, -50 °C	507
W-TYPE for aggressive environments	522
E-Xtreme® corrosion proof	532 - 533, 543, 552 - 553
EMC	579
Central lever	606 - 608
LS-TYPE	620 - 621
IP68	636 - 639
panel supports: COB	page: 652 - 653

inserts, spring terminal connections without tools



coding pins



description	part No.	part No.
-------------	----------	----------

spring terminals with actuator button
female inserts with female contacts
male inserts with male contacts

CDSHF 18
CDSHM 18

plastic coding pins

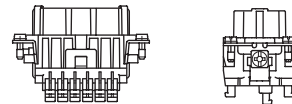
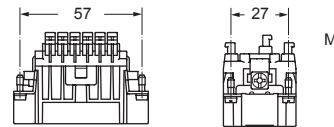
CR CDS

- characteristics according to EN 61984:

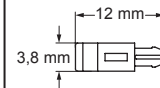
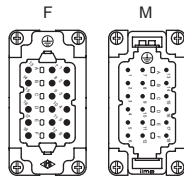
10A 400V 6kV 3
10A 400V/690V 6kV 2

- certified

- rated voltage according to UL/CSA: 600V
- insulation resistance: $\geq 10 \text{ G}\Omega$
- ambient temperature limit: $-40 \text{ }^\circ\text{C} \dots +125 \text{ }^\circ\text{C}$
- made of self-extinguishing thermoplastic resin UL 94V-0
- mechanical life: ≥ 500 cycles
- contact resistance: $\leq 3 \text{ m}\Omega$
- for max. current load see the connector inserts derating diagram below; for more information see page 28



contacts side (front view)

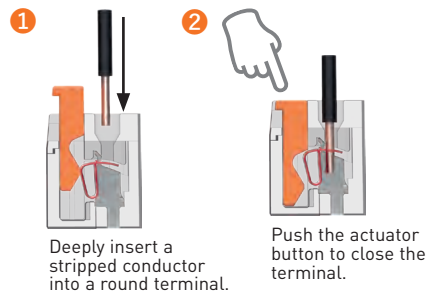


CDSH series - Coding with CR CDS pins

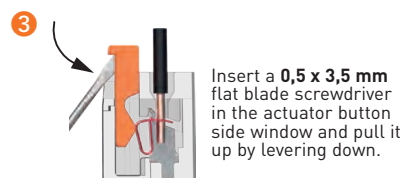
Size of connectors	Slots for coding pins (M) = male insert (F) = female insert	Required coding pins for each coupling	Possible codings
18P + ⊕	6 (M) + 6 (F)	6 3 (M) + 3 (F)	20

- inserts for conductors cross-sectional areas: 0,14 - 2,5 mm² - AWG 26 - 14
- for wires with crimped ferrule, usable section: up to 1,5 mm² (AWG 16)
- conductors stripping length: 9...11 mm

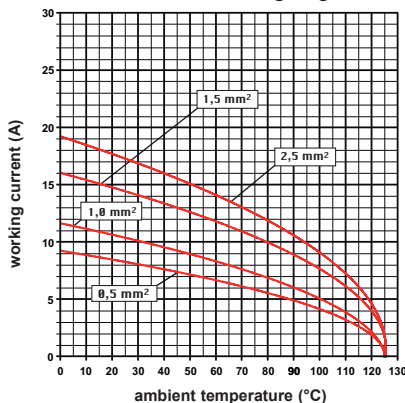
SQUICH®-spring connection technology WIRING



RE-OPENING



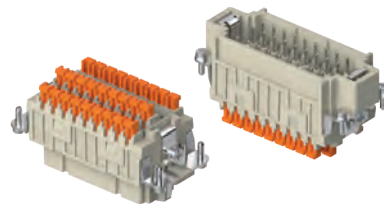
CDSH 18 poles connector inserts
Maximum current load derating diagram



CDSH-SQUICH® 27 poles + ⊕ 10A - 400V

enclosures: size "77.27"	page:
C-TYPE IP65 or IP66/IP69	402 - 411
C7 IP67, two levers	439 - 440
V-TYPE IP65 or IP66/IP69, single lever	454 - 458
BIG hoods	470 - 471
T-TYPE IP65 insulating	484 - 485
T-TYPE / W IP66/IP69 insulating	491
HYGIENIC T-TYPE / H IP66/IP69	503
HYGIENIC T-TYPE / C IP66/IP69, -50 °C	508
W-TYPE for aggressive environments	523
E-Xtreme® corrosion proof	534 - 535, 544, 554 - 555
EMC	580
Central lever	609 - 611
LS-TYPE	622 - 623
IP68	640 - 643
panel supports: COB	page: 652 - 653

inserts, spring terminal connections without tools



coding pins



description	part No.	part No.
-------------	----------	----------

spring terminals with actuator button
female inserts with female contacts
male inserts with male contacts

CDSHF 27
CDSHM 27

plastic coding pins

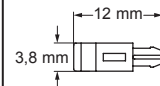
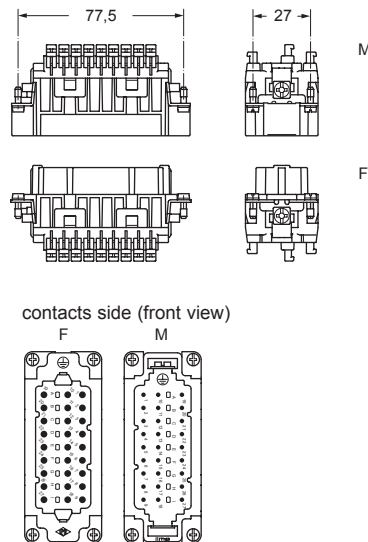
CR CDS

- characteristics according to EN 61984:

10A 400V 6kV 3
10A 400V/690V 6kV 2

- certified

- rated voltage according to UL/CSA: 600V
- insulation resistance: $\geq 10 \text{ G}\Omega$
- ambient temperature limit: $-40 \text{ }^\circ\text{C} \dots +125 \text{ }^\circ\text{C}$
- made of self-extinguishing thermoplastic resin UL 94V-0
- mechanical life: ≥ 500 cycles
- contact resistance: $\leq 3 \text{ m}\Omega$
- for max. current load see the connector inserts derating diagram below; for more information see page 28

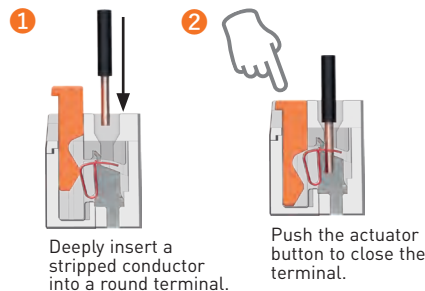


CDSH series - Coding with CR CDS pins

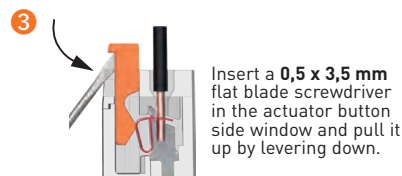
Size of connectors	Slots for coding pins (M) = male insert (F) = female insert	Required coding pins for each coupling	Possible codings
27P + ⊕	9 (M) + 9 (F)	9 5 (M) + 4 (F)	126

- inserts for conductors cross-sectional areas: 0,14 - 2,5 mm² - AWG 26 - 14
- for wires with crimped ferrule, usable section: up to 1,5 mm² (AWG 16)
- conductors stripping length: 9...11 mm

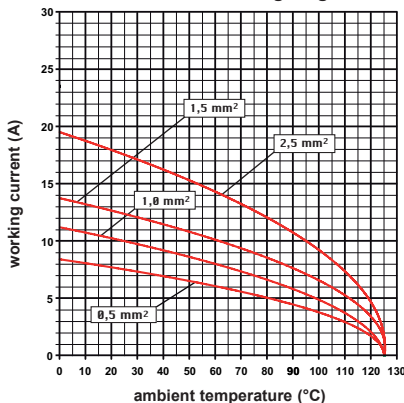
SQUICH®-spring connection technology WIRING



RE-OPENING



CDSH 27 poles connector inserts
Maximum current load derating diagram

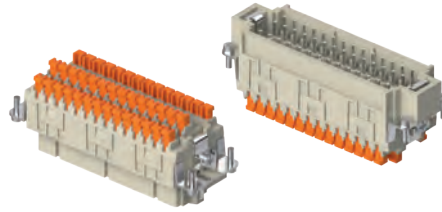


CDSH-SQUICH®

CDSH-SQUICH® 42 poles + ⊕ 10A - 400V

enclosures: size "104.27"	page:
C-TYPE IP65 or IP66/IP69	412 - 423
C7 IP67, two levers	441 - 442
V-TYPE IP65 or IP66/IP69, single lever	459 - 463
BIG hoods	472 - 473
T-TYPE IP65 insulating	486 - 487
T-TYPE / W IP66/IP69 insulating	492
HYGIENIC T-TYPE / H IP66/IP69	504
HYGIENIC T-TYPE / C IP66/IP69, -50 °C	509
W-TYPE for aggressive environments	524
E-Xtreme® corrosion proof	536 - 537, 545, 556 - 557
EMC	581
Central lever	612 - 614
LS-TYPE	624 - 625
IP68	644 - 647
panel supports: COB	page: 652 - 653

inserts, spring terminal connections without tools

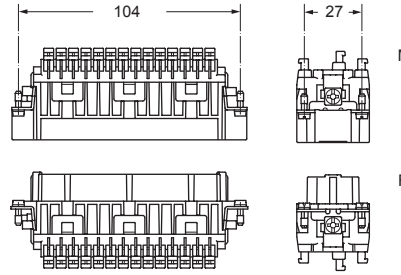


coding pins

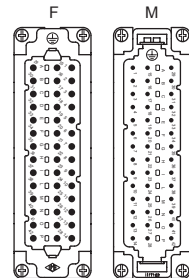


description	part No.	part No.
spring terminals with actuator button	CDSHF 42	CR CDS
female inserts with female contacts	CDSHM 42	
male inserts with male contacts		
plastic coding pins		

- characteristics according to EN 61984:
10A 400V 6kV 3
10A 400V/690V 6kV 2
- certified
- rated voltage according to UL/CSA: 600V
- insulation resistance: ≥ 10 GΩ
- ambient temperature limit: -40 °C ... +125 °C
- made of self-extinguishing thermoplastic resin UL 94V-0
- mechanical life: ≥ 500 cycles
- contact resistance: ≤ 3 mΩ
- for max. current load see the connector inserts derating diagram below; for more information see page 28

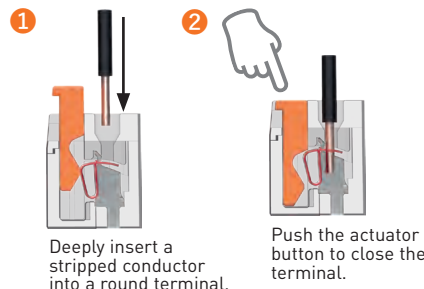


contacts side (front view)

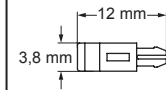
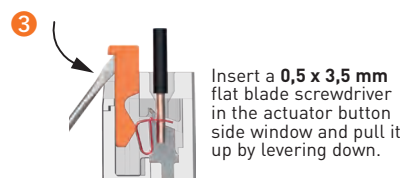


- inserts for conductors cross-sectional areas: 0,14 - 2,5 mm² - AWG 26 - 14
- for wires with crimped ferrule, usable section: up to 1,5 mm² (AWG 16)
- conductors stripping length: 9...11 mm

SQUICH®-spring connection technology WIRING



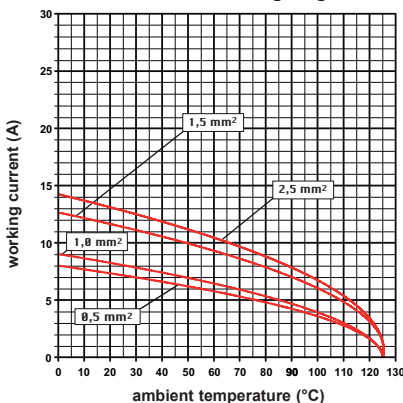
RE-OPENING



CDSH series - Coding with CR CDS pins

Size of connectors	Slots for coding pins (M) = male insert (F) = female insert	Required coding pins for each coupling	Possible codings
42P + ⊕	14 (M) + 14 (F)	14 7 (M) + 7 (F)	3.432

CDSH 42 poles connector inserts
Maximum current load derating diagram



CDSH-SQUICH® 54 poles + ⊕ 10A - 400V

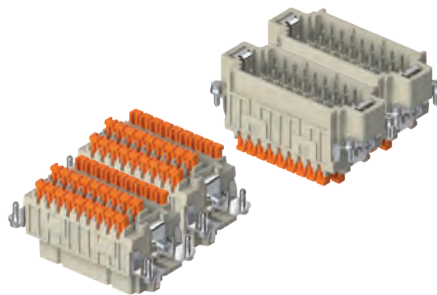
enclosures:
size "77.62"

page:

C-TYPE IP65 or IP66/IP69
W-TYPE for aggressive environments
E-Xtreme® corrosion proof

424 - 429
525
546

inserts,
spring terminal connections without tools



coding pins



description

part No.

part No.

part No.

spring terminals with actuator button
female inserts with female contacts, No. (1-27) and (28-54)
male inserts with male contacts, No. (1-27) and (28-54)

CDSHF 27
CDSHM 27

CDSHF 27 N
CDSHM 27 N

plastic coding pins

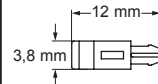
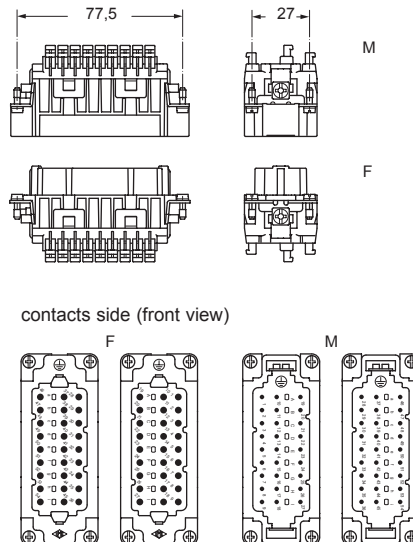
CR CDS

- characteristics according to EN 61984:

10A 400V 6kV 3
10A 400V/690V 6kV 2

- certified

- rated voltage according to UL/CSA: 600V
- insulation resistance: $\geq 10 \text{ G}\Omega$
- ambient temperature limit: $-40 \text{ }^\circ\text{C} \dots +125 \text{ }^\circ\text{C}$
- made of self-extinguishing thermoplastic resin UL 94V-0
- mechanical life: ≥ 500 cycles
- contact resistance: $\leq 1 \text{ m}\Omega$
- for max. current load see the connector inserts derating diagram below; for more information see page 28



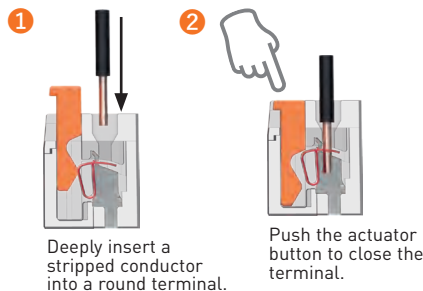
CDSH series - Coding with CR CDS pins

Size of connectors	Slots for coding pins (M) = male insert (F) = female insert	Required coding pins for each coupling	Possible codings
54P + ⊕			
27P + ⊕	9 (M) + 9 (F)	9 5 (M) + 4 (F)	126 x
27P + ⊕	9 (M) + 9 (F)	9 5 (M) + 4 (F)	126

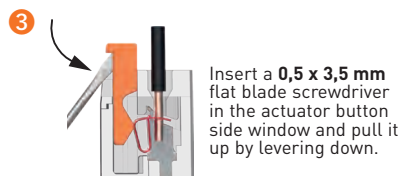
- inserts for conductors cross-sectional areas: 0,14 - 2,5 mm² - AWG 26 - 14
- for wires with crimped ferrule, usable section: up to 1,5 mm² (AWG 16)
- conductors stripping length: 9...11 mm

SQUICH®-spring connection technology

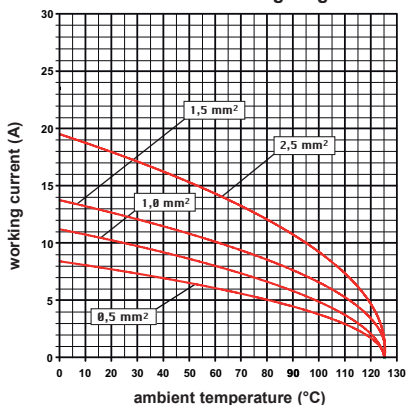
WIRING



RE-OPENING



CDSH 54 poles connector inserts
Maximum current load derating diagram



CDSH-SQUICH®

CDSH-SQUICH® 84 poles + ⊕ 10A - 400V

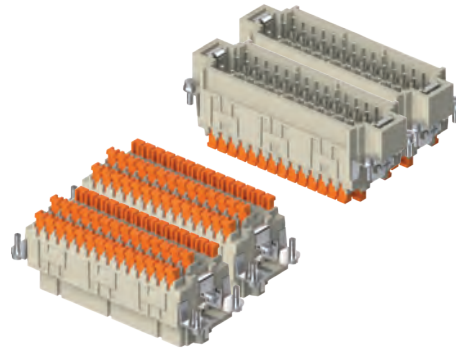
enclosures:
size "104.62"

page:

C-TYPE IP65 or IP66/IP69
W-TYPE for aggressive environments
E-Extreme® corrosion proof

430
526
547

inserts, spring terminal connections without tools



coding pins



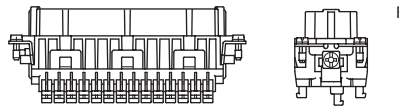
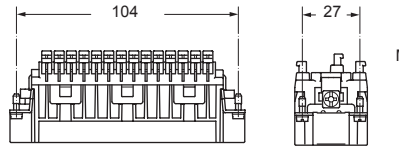
description	part No.	part No.	part No.
spring terminals with actuator button			
female inserts with female contacts, No. (1-42) and (43-84)	CDSHF 42	CDSHF 42 N	
male inserts with male contacts, No. (1-42) and (43-84)	CDSHM 42	CDSHM 42 N	
plastic coding pins			CR CDS

- characteristics according to EN 61984:

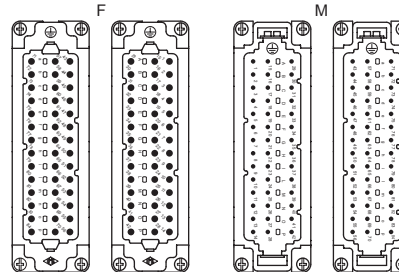
10A 400V 6kV 3
10A 400V/690V 6kV 2

- certified

- rated voltage according to UL/CSA: 600V
- insulation resistance: $\geq 10 \text{ G}\Omega$
- ambient temperature limit: $-40 \text{ }^\circ\text{C} \dots +125 \text{ }^\circ\text{C}$
- made of self-extinguishing thermoplastic resin UL 94V-0
- mechanical life: ≥ 500 cycles
- contact resistance: $\leq 1 \text{ m}\Omega$
- for max. current load see the connector inserts derating diagram below; for more information see page 28

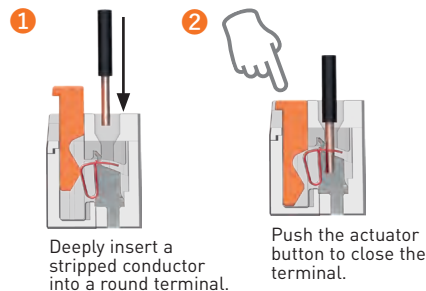


contacts side (front view)

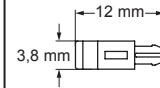
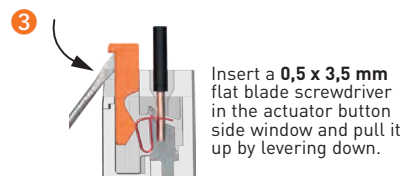


- inserts for conductors cross-sectional areas: 0,14 - 2,5 mm² - AWG 26 - 14
- for wires with crimped ferrule, usable section: up to 1,5 mm² (AWG 16)
- conductors stripping length: 9...11 mm

SQUICH®-spring connection technology WIRING



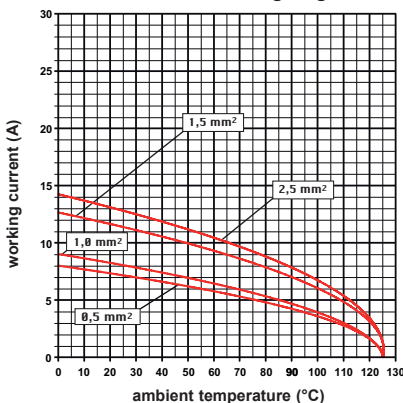
RE-OPENING



CDSH series - Coding with CR CDS pins

Size of connectors	Slots for coding pins (M) = male insert (F) = female insert	Required coding pins for each coupling	Possible codings
84P + ⊕			
42P + ⊕	14 (M) + 14 (F)	14 7 (M) + 7 (F)	3.432 x
42P + ⊕	14 (M) + 14 (F)	14 7 (M) + 7 (F)	3.432

CDSH 84 poles connector inserts
Maximum current load derating diagram



CDSH NC-SQUICH® series

3 contact pairs with an AutoShort NC contact element

ILME developed an **innovative connector suitable for interfacing measuring current transformers (CTs)** with the dedicated electronic measurement processing equipment. Use of such systems is increasing in transformer substations with the diffusion of smart grid concepts due to the growth of self-standing power generation plants (photovoltaic, wind).

The CDSH...NC connector has the **same dimensions of a 6 poles size "44.27" CSH connector**, and it is **easy to wire** thanks to ILME proprietary SQUICH® tool-less quick connection technology.

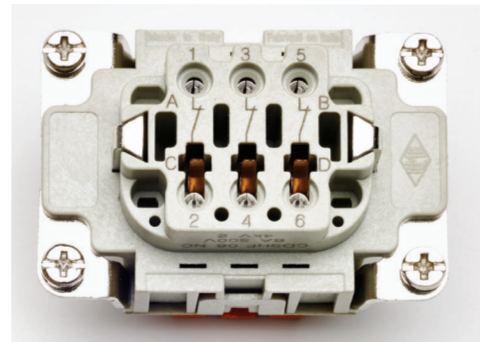
Inside the female insert, for each of the three contact pairs 1-2, 3-4 and 5-6, a **suitable spring element is foreseen**, providing a NC (normally closed) contact between the female contact pair. The said short-circuit element automatically establishes a short-circuit between the female contact pair while the connector is being unmated, before the complete withdrawal of the corresponding male connector.

This protects the measuring current transformer's secondary windings to which this connector is deemed to be wired, against the high voltage that would arise if the ends of each winding were left open while the primary winding (the power line busbars) are still under load.

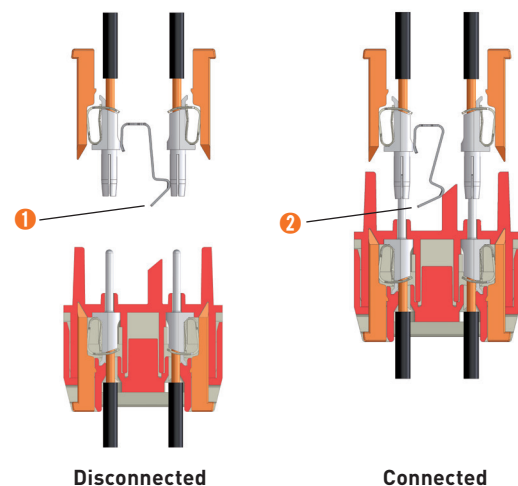
AUTOSHORT NC Operating principles

CDSH...NC connector can be used only for connecting up to three secondary (output) windings of measuring current transformers to specific measuring circuits; on the female side each contact pair is provided with said AutoShort NC contact element ❶ to keep the secondary winding ends shorted while the female connector is not engaged with the male connector, thus avoiding damages to the insulation of the current transformer and consequent hazardous condition for the personnel operating the unmating of the connector while the power busbars are energized. When the female and male connectors are being mated ❷, the short-circuit is released after proper electrical engagement of the two connector halves, thus allowing again current measurement by the dedicated electronic measurement processing equipment wired on the male connector side.

This connector inserts can be used in size "44.27" connector enclosures, either metal (conductive) or thermoplastics (insulating), with up to IP68 degree of protection (IP66/IP68 with series CG/MG), within enclosures for aggressive environments (series "W") or with up to IP66/IP69 within series T-TYPE HYGIENIC enclosures for hygienic applications.



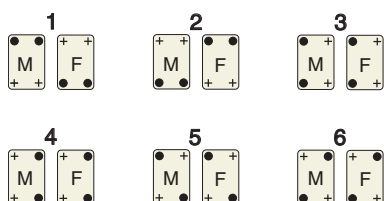
During the mating of these specially designed connector inserts, three corresponding actuator buttons realized on the mating face of the male connector, once the male contacts are already engaged with the corresponding female contacts, push aside the facing end of the AutoShort NC contact element, in order to release the short-circuit previously provided. In mated condition the proper termination of the secondary windings of the CT must be provided by the customer's downstream circuit, e.g. by suitable resistors.



AUTOSHORT NC Coding pins

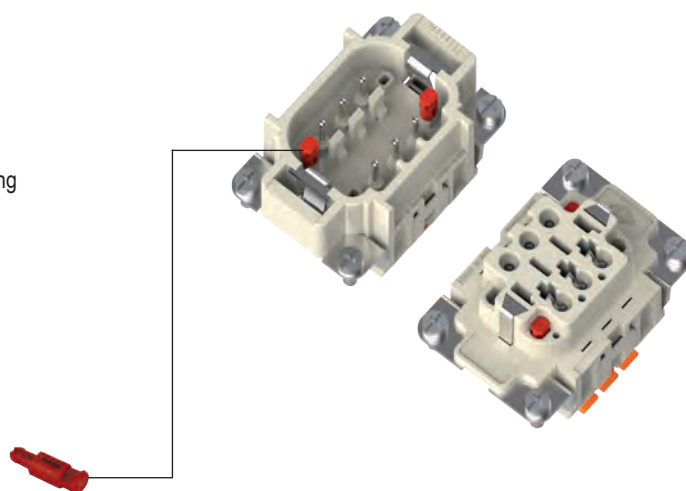
Optionally, it is possible to add **four special coding pins CR CDS** that allow up to 6 different codings, by installing 2 coding pins on the male connector half and correspondingly 2 on the female connector half, according to the coding scheme provided in the following:

CODING SCHEME



Legend

- = coding pin installed
- + = no coding pin



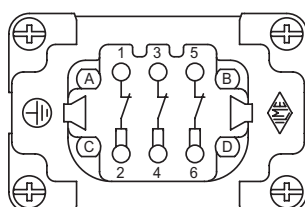
The CR CDS coding pins can also be used in combination with other CR 20 / CRM / CRF / CR 72 metal pins instead of insert fixing screws in order to increase the number of possible combinations.

AUTOSHORT NC PIN Assignment

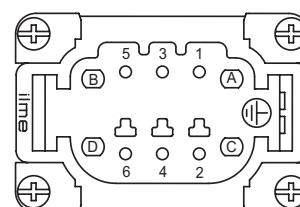
Female inserts with NC shorting contacts between contacts of pairs 1-2, 3-4, 5-6, opening upon with male inserts.
Pin assignment of contacts for the connector is the following:

Pin	Assignment
1	Winding 1 start
2	Winding 1 end
3	Winding 2 start
4	Winding 2 end
5	Winding 3 start
6	Winding 3 end
PE	⊕ Protective Earth

View from the contact side



Female



Male

CDSH NC-SQUICH® series

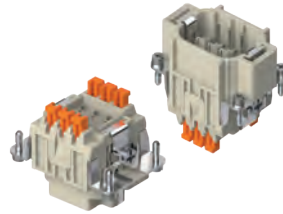
TECHNICAL FEATURES

Insert series	CDSH NC-SQUICH®
Electrical contacts	6 spring clamp type built-in contacts with actuator (SQUICH®) made by copper alloy, silver plated
Rated current	6A 250V 4kV 3; 6A 500V 4kV 2 according to EN 61984 Fault condition (rated short time thermal current): 50A for 1 s
Contact resistance (connector mated)	≤ 3 mΩ
Insulation resistance	≥ 10 GΩ
Ambient temperature limit (°C)	min. -40 max. +125
Degree of protection	IP20 (IPXXB) (connector without housing, in mated condition), IP65 or IP66 (connectors in T-TYPE housings), IP66 or more (connectors in ILME metal housings)
Conductor connections	3 pairs of contacts (with autoshunt on each pair of female connector), plus protective earth, size 44.27 housings
Conductor cross-sectional area	0,14 - 2,5 mm ² (AWG 26 - 14) for solid or unprepared stranded copperwires 0,14 - 1,5 mm ² (AWG 26 - 16) for stranded copper wires prepared with ferrules
Flammability	94V-0 according to UL 94
Mechanical endurance (mating cycles)	≥ 50

CDSH NC-SQUICH® 6 poles + ⊕ 6A - 250V

enclosures: size "44.27"	page:
C-TYPE IP65 or IP66/IP69	387 - 392
C7 IP67, single lever	436 - 437
V-TYPE IP65 or IP66/IP69, single lever	444 - 447
BIG hoods	466 - 467
T-TYPE IP65 insulating	480 - 481
T-TYPE / W IP66/IP69 insulating	489
HYGIENIC T-TYPE / H IP66/IP69	501
HYGIENIC T-TYPE / C IP66/IP69, -50 °C	506
W-TYPE for aggressive environments	521
E-Xtreme® corrosion proof	530 - 531, 542, 550 - 551
EMC	578
Central lever	603 - 605
LS-TYPE	618 - 619
IP68	632 - 635
panel supports:	page:
COB	652 - 653

inserts,
spring clamp connections with actuator
button, female inserts with NC shorting
contacts



coding pins



Q SILVER PLATED CONTACTS

description	part No.	part No
-------------	----------	---------

spring terminals with actuator button
female inserts with female contacts
male inserts with male contacts

CDSHF 06 NC
CDSHM 06 NC

plastic coding pins

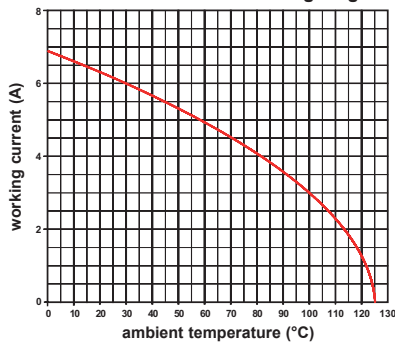
CR CDS

- characteristics according to EN 61984:

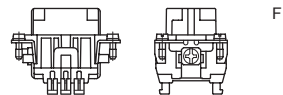
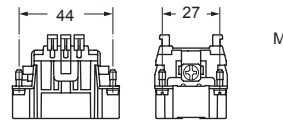
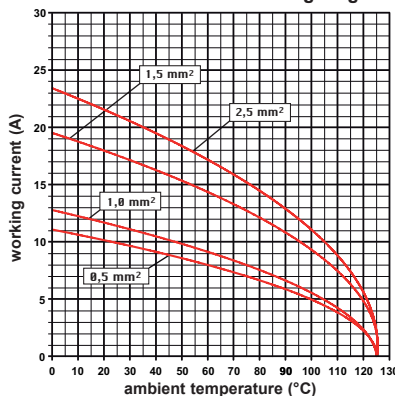
6A 250V 4kV 3
6A 500V 4kV 2
10A with connector mated

- certified
- rated voltage according to UL/CSA: 600V
- insulation resistance: $\geq 10 \text{ G}\Omega$
- ambient temperature limit: $-40 \text{ }^\circ\text{C} \dots +125 \text{ }^\circ\text{C}$
- made of self-extinguishing thermoplastic resin 94V-0 according to UL 94
- mechanical life: ≥ 50 cycles
- contact resistance: $\leq 3 \text{ m}\Omega$
- NC = Normally Closed
- the diagrams (1) and (2) below show respectively the maximum current-carrying capacity:
- (1) of the AutoShort female connector uncoupled, with the three NC contacts that short circuit the individual circuits upstream wired in series on each contact pair. In this condition the AutoShort connector can be loaded up to 6 A. For this maximum current it can be wired from $0,75 \text{ mm}^2 / 18 \text{ AWG}$ through $2,5 \text{ mm}^2 / 14 \text{ AWG}$ with no significant performance differences;
- (2) of the AutoShort female connector coupled to the corresponding male AutoShort connector (NC contacts open) (for further information see page 28).

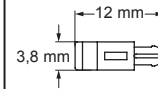
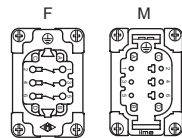
(1) CDSHF NC 06 poles connector inserts
Maximum current load derating diagram



(2) CDSHF NC 06 poles connector inserts
Maximum current load derating diagram

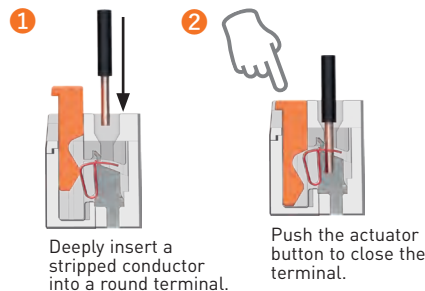


contacts side (front view)

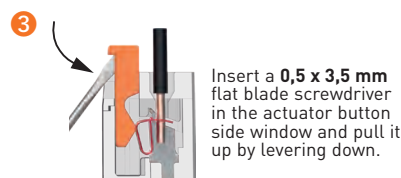


- inserts for conductors section:
 $0,14 - 2,5 \text{ mm}^2 - \text{AWG } 26 - 14$
- for wires with crimped ferrule, useful cross-section:
up to $1,5 \text{ mm}^2$ (AWG 16)
- conductors stripping length: 9...11 mm

SQUICH®-spring connection technology WIRING



RE-OPENING



CDA-CDC series

The compact inserts

CDA inserts with screw-type termination

The screw-type connector inserts CDA series with 10 and 16 poles + ⊕ are now made using screw-type terminals (CNE series) with a built-in wire protection pressure plate of proven reliability and practicality.

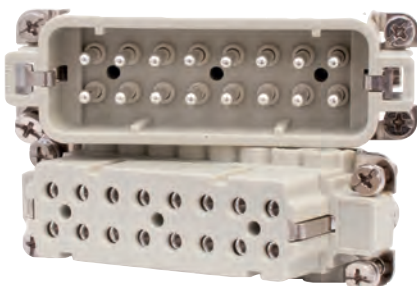
The wire protection pressure plate preserves the conductors in case of wiring with **unprepared conductors** (i.e. without wire end ferrules) up to a maximum wire cross-section of **4 mm²** (12 AWG).

The variant without a wire protection pressure plate (code with suffix X) is also available, for use with **prepared conductors** featuring a wire end ferrule with a maximum usable wire cross-section of **2,5 mm²** (14 AWG).



CDC inserts with crimp termination

The crimp termination CDC series of inserts with 10 and 16 poles + ⊕ now adopt the tried and tested contact retention technique of connector series CCE and CQE for removable crimp contacts (series CC, max 16A).



CDA-CDC INSERTS SUM-UP

- ☑ According to standard EN 61984:
16A 250V 4kV 3
16A 230/400V 4kV 2
- ☑ Insulation resistance: $\geq 10 \text{ G}\Omega$
- ☑ Ambient temperature limit: $-40 \text{ }^\circ\text{C} \dots +125 \text{ }^\circ\text{C}$
- ☑ Construction material: UL 94 V-0 self-extinguishing thermoplastic resin
- ☑ Mechanical life: ≥ 500 cycles
- ☑ Built-in silver plated contacts (only CDA series)

The applications

Like those of the previous series, CDA and CDC inserts and their enclosures are used in accordance with the recommendations EUROMAP 12, EUROMAP 13, EUROMAP 14-1, EUROMAP 16 and EUROMAP 62 (European industry consortium for moulding machines and plastic processing).

The CDC inserts can also be used with CC series crimp contacts made of iron/constantan (Fe-CuNi) for the cabling of J type thermocouples in accordance with IEC/EN 60584-1 (EUROMAP 14-1 recommendation).

The CDA/CDC series inserts can also be coupled with previous insert versions.



CSAH-SQUICH® series

Connection without tools, slim version

CSAH-SQUICH® inserts

To improve high performance industrial connections, ILME has developed and evolved its own spring clamp connectors to meet the market needs and make installation simpler.

The SQUICH® inserts are adaptable to any type of solid or flexible conductor, including unprepared conductors

Each of the spring terminals has an actuator button, suitably shaped and incorporated in the cavity. When this button is pressed, it triggers the closure of the spring device of the corresponding terminal, safely and reliably connecting the conductor to its respective electric contact in the connector.

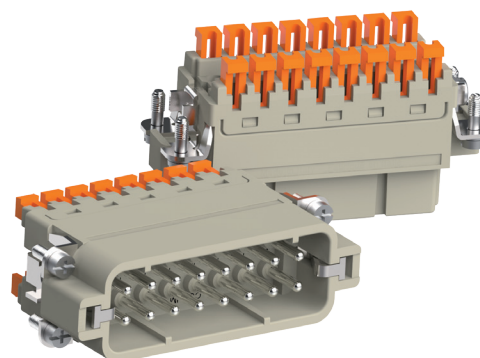
The actuator buttons are supplied raised, in the "open terminal" position and are easily distinguishable by the **orange colour which makes them stand out from the insulating body of the connector.**

The advantage of such an **exclusive solution** is that the **actuators disappear completely within the body of the connector**, making it easy to identify terminals not yet closed and eliminating possible obstacles to the movement of the conductors during installation and maintenance. In this manner during the cabling phase the **need for a tool to activate the terminal is completely eliminated and a simple operation is all you need to make the connection.**

Shaped button for measuring instruments

The profile of the button used in the **SQUICH®** series inserts **allow a measuring probe to be inserted.**

This allows checks to be carried out to ensure that the wiring is correct.



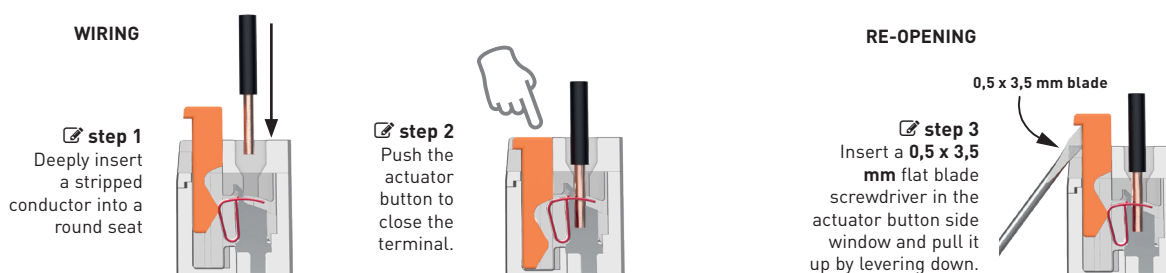
CSAH-SQUICH® INSERTS SUM-UP

- ☑ **Reduced space**
- ☑ **Reduced wiring time**
- ☑ **No need for tools**
- ☑ **Quick identification of wired and non-wired terminals**
- ☑ **Terminals already open and ready for conductor clamping**
- ☑ **Built-in silver plated contacts**
- ☑ **Excellent fastening solution**
- ☑ **Great resistance to strong vibration**

Simple terminal reopening

To reopen the terminals, simply introduce the tip of a common 0,5 x 3,5 mm flat blade screwdriver in the shaped pocket on the head of the actuator, and slightly rotate the screwdriver downwards: this will lift the actuator into its open terminal position.

☑ SQUICH® Connection technology



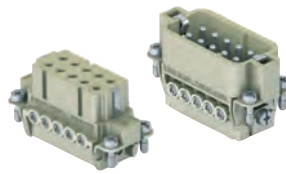
CDA 10 poles + ⊕ 16A - 250V

enclosures:
size "49.16" page:

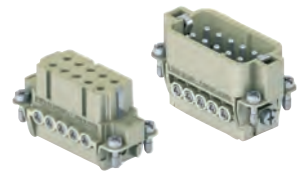
IL-BRID 374 - 377, 382
 CZ7 IP67, single lever 384
 W-TYPE for aggressive environments 519
 E-Xtreme® corrosion proof 540
 EMC 576

panel supports: page:
 COB + adaptor 652 - 654

inserts, screw terminal connection



inserts, screw terminal connection



description

part No.

part No.

indirect, with pressure plate ¹⁾
 female inserts with female contacts
 male inserts with male contacts

CDAF 10
CDAM 10

direct, without pressure plate ²⁾
 female inserts with female contacts
 male inserts with male contacts

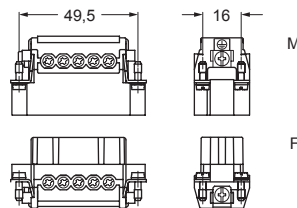
CDAF 10 X
CDAM 10 X

- characteristics according to EN 61984:

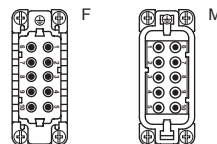
16A 250V 4kV 3
16A 230/400V 4kV 2

- (UL for USA and Canada),
ERC certified

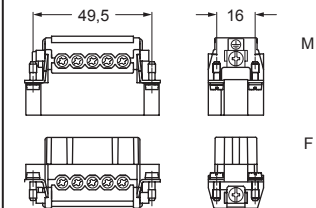
- rated voltage according to UL/CSA: 600V
- insulation resistance: ≥ 10 GΩ
- ambient temperature limit: -40 °C ... +125 °C
- made of self-extinguishing thermoplastic resin UL 94V-0
- mechanical life: ≥ 500 cycles
- contact resistance: ≤ 1 mΩ
- according to recommendations EUROMAP N° 16
- for max. current load see the connector inserts derating diagram below; for more information see page 28



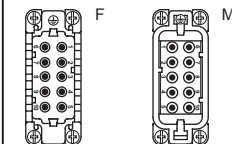
contacts side (front view)



- inserts with pressure plate for conductors cross-sections:
0,5 - 4 mm² - AWG 20 - 12
- conductors stripping length: 7 mm
- terminal screw torque: 0,5 Nm (4.4 lb.in), for more information see page 20 and 21

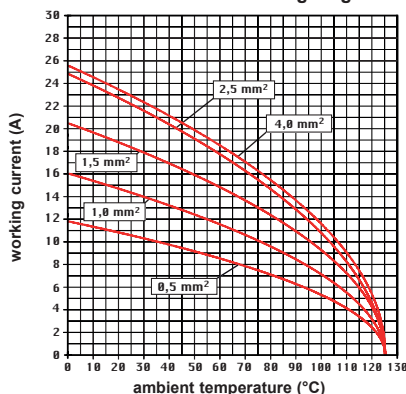


contacts side (front view)



- inserts without pressure plate for prepared conductors with cross-sections:
0,25 - 2,5 mm² - AWG 24 - 14
- terminal screw torque: 0,5 Nm (4.4 lb.in), for more information see page 20 and 21

CDA 10 poles connector inserts
Maximum current load derating diagram



¹⁾ for unprepared conductors



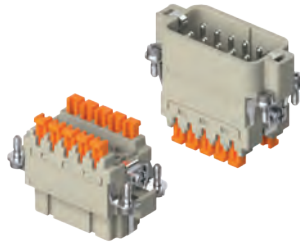
²⁾ for conductors with end sleeve ferrule



CSAH-SQUICH® 10 poles + ⊕ 16A - 250V

enclosures: size "49.16"	page:
IL-BRID	374 - 377, 382
CZ7 IP67, single lever	384
W-TYPE for aggressive environments	519
E-Xtreme® corrosion proof	540
EMC	576
panel supports: COB + adaptor	page: 652 - 654

inserts, spring terminal connections without tools

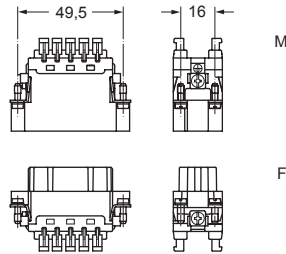


description	part No.
-------------	----------

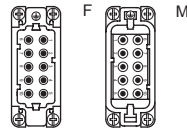
spring terminals with actuator button
female inserts with female contacts
male inserts with male contacts

CSAHF 10
CSAHM 10

- characteristics according to EN 61984:
16A 250V 4kV 3
16A 400V 4kV 2
- certified
- rated voltage according to UL/CSA: 600V
- insulation resistance: $\geq 10 \text{ G}\Omega$
- ambient temperature limit: $-40 \text{ }^\circ\text{C} \dots +125 \text{ }^\circ\text{C}$
- made of self-extinguishing thermoplastic resin UL 94V-0
- mechanical life: ≥ 500 cycles
- contact resistance: $\leq 3 \text{ m}\Omega$
- for max. current load see the connector inserts derating diagram below; for more information see page 28

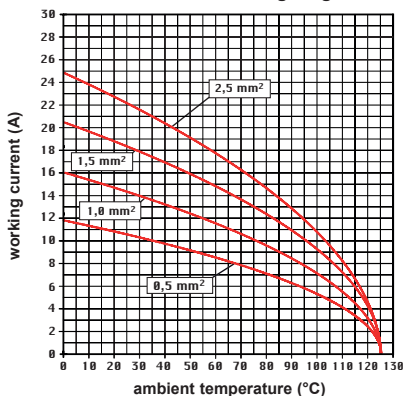


contacts side (front view)



- inserts for conductors with the following sections:
0,14 - 2,5 mm² - AWG 26 - 14
- for wires with crimped ferrule, usable section:
up to 1,5 mm² (AWG 16)
- conductors stripping length: 9...11 mm

CSAH 10 poles connector inserts
Maximum current load derating diagram



SQUICH®-spring connection technology

WIRING

- Deeply insert a stripped conductor into a round terminal.
- Push the actuator button to close the terminal.

RE-OPENING

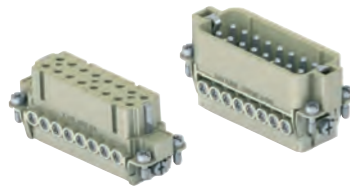
- Insert a **0,5 x 3,5 mm** flat blade screwdriver in the actuator button side window and pull it up by levering down.

CDA 16 poles + ⊕ 16A - 250V

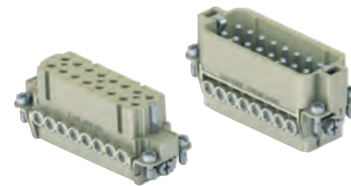
enclosures: size "66.16"	page:
IL-BRID	378 - 382
CZ7 IP67, single lever	385
W-TYPE for aggressive environments	520
E-Xtreme® corrosion proof	541
EMC	577

panel supports: COB + adaptor	page: 652 - 654
----------------------------------	--------------------

inserts, screw terminal connection



inserts, screw terminal connection



description

part No.

part No.

indirect, with pressure plate ¹⁾
female inserts with female contacts
male inserts with male contacts

CDAF 16
CDAM 16

direct, without pressure plate ²⁾
female inserts with female contacts
male inserts with male contacts

CDAF 16 X
CDAM 16 X

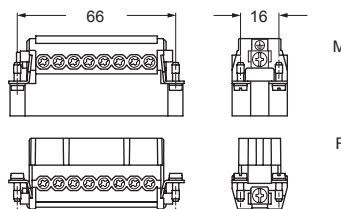
- characteristics according to EN 61984:

16A 250V 4kV 3
16A 230/400V 4kV 2

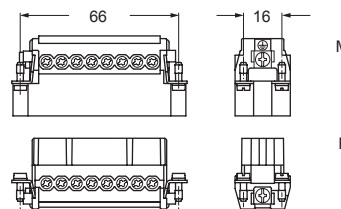
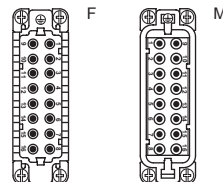
- cULus (UL for USA and Canada),

certified

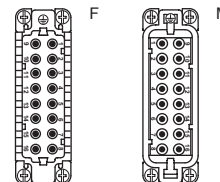
- rated voltage according to UL/CSA: 600V
- insulation resistance: $\geq 10 \text{ G}\Omega$
- ambient temperature limit: $-40 \text{ }^\circ\text{C} \dots +125 \text{ }^\circ\text{C}$
- made of self-extinguishing thermoplastic resin UL 94V-0
- mechanical life: ≥ 500 cycles
- contact resistance: $\leq 1 \text{ m}\Omega$
- according to recommendations EUROMAP N° 13 / N° 14.1
- for max. current load see the connector inserts derating diagram below; for more information see page 28



contacts side (front view)



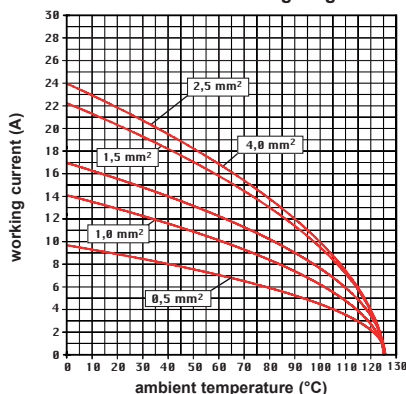
contacts side (front view)



- inserts with pressure plate for conductors cross-sections:
0,5 - 4 mm² - AWG 20 - 12
- conductors stripping length: 7 mm
- terminal screw torque: 0,5 Nm (4.4 lb.in), for more information see page 20 and 21

- inserts without pressure plate for prepared conductors with cross-sections:
0,25 - 2,5 mm² - AWG 24 - 14
- terminal screw torque: 0,5 Nm (4.4 lb.in), for more information see page 20 and 21

CDA 16 poles connector inserts
Maximum current load derating diagram



¹⁾ for unprepared conductors



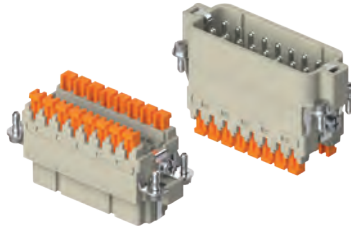
²⁾ for conductors with end sleeve ferrule



CSAH-SQUICH® 16 poles + ⊕ 16A - 250V

enclosures: size "66.16"	page:
IL-BRID	378 - 382
CZ7 IP67, single lever	385
W-TYPE for aggressive environments	520
E-Xtreme® corrosion proof	541
EMC	577
panel supports: COB + adaptor	page: 652 - 654

inserts, spring terminal connections without tools

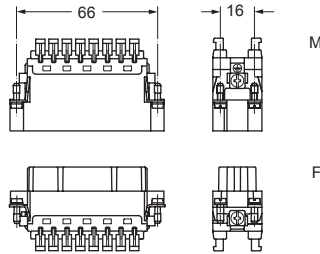


description	part No.
-------------	----------

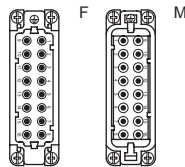
spring terminals with actuator button
female inserts with female contacts
male inserts with male contacts

CSAHF 16
CSAHM 16

- characteristics according to EN 61984:
16A 250V 4kV 3
16A 400V 4kV 2
- (UL for USA and Canada), certified
- rated voltage according to UL/CSA: 600V
- insulation resistance: $\geq 10 \text{ G}\Omega$
- ambient temperature limit: $-40 \text{ }^\circ\text{C} \dots +125 \text{ }^\circ\text{C}$
- made of self-extinguishing thermoplastic resin UL 94V-0
- mechanical life: ≥ 500 cycles
- contact resistance: $\leq 3 \text{ m}\Omega$
- for max. current load see the connector inserts derating diagram below; for more information see page 28

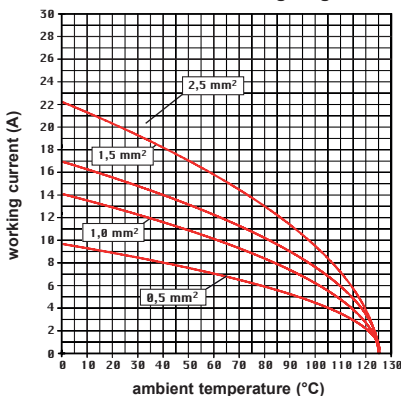


contacts side (front view)



- inserts for conductors with the following sections:
0,14 - 2,5 mm² - AWG 26 - 14
- for wires with crimped ferrule, usable section:
up to 1,5 mm² (AWG 16)
- conductors stripping length: 9...11 mm

CSAH 16 poles connector inserts
Maximum current load derating diagram



SQUICH®-spring connection technology

WIRING

- Deeply insert a stripped conductor into a round terminal.
- Push the actuator button to close the terminal.

RE-OPENING

- Insert a **0,5 x 3,5 mm** flat blade screwdriver in the actuator button side window and pull it up by levering down.

CDA 32 poles + ⊕ 16A - 250V

enclosures:
size "66.40"

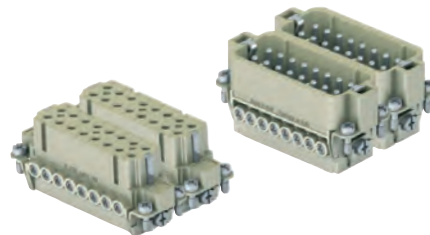
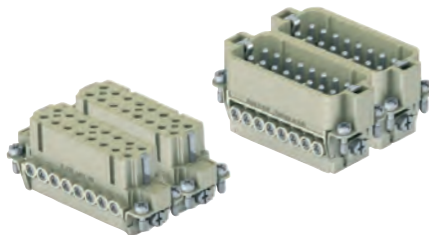
page:

C-TYPE IP65 or IP66/IP69
W-TYPE for aggressive environments
E-Extreme® corrosion proof

431 - 434
527
548

inserts,
screw terminal connection

inserts,
screw terminal connection



description

part No.

part No.

part No.

part No.

indirect, with pressure plate ¹⁾
female inserts, No. (1-16) and (17-32)
male inserts, No. (1-16) and (17-32)

CDAF 16
CDAM 16

CDAF 16 N
CDAM 16 N

direct, without pressure plate ²⁾
female inserts, No. (1-16) and (17-32)
male inserts, No. (1-16) and (17-32)

CDAF 16 X
CDAM 16 X

CDAF 16 XN
CDAM 16 XN

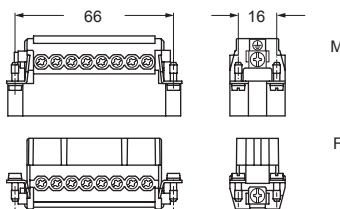
- characteristics according to EN 61984:

16A 250V 4kV 3
16A 230/400V 4kV 2

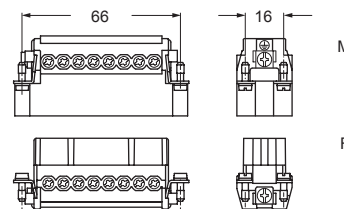
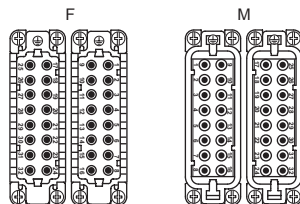
- cULus (UL for USA and Canada),

certified

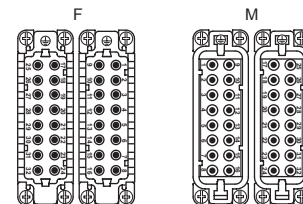
- rated voltage according to UL/CSA: 600V
- insulation resistance: $\geq 10 \text{ G}\Omega$
- ambient temperature limit: $-40 \text{ }^\circ\text{C} \dots +125 \text{ }^\circ\text{C}$
- made of self-extinguishing thermoplastic resin UL 94V-0
- mechanical life: ≥ 500 cycles
- contact resistance: $\leq 1 \text{ m}\Omega$
- according to recommendations EUROMAP N° 12 / N° 62
- for max. current load see the connector inserts derating diagram below; for more information see page 28



contacts side (front view)



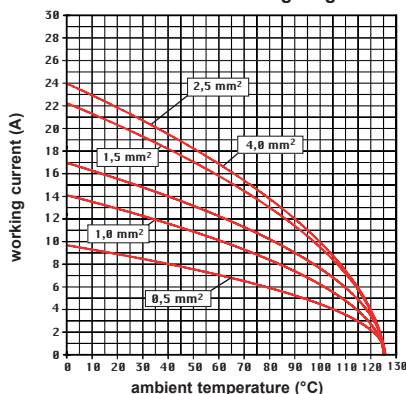
contacts side (front view)



- inserts with pressure plate for conductors cross-sections: 0,5 - 4 mm² - AWG 20 - 12
- conductors stripping length: 7 mm
- terminal screw torque: 0,5 Nm (4.4 lb.in), for more information see page 20 and 21

- inserts without pressure plate for prepared conductors with cross-sections: 0,25 - 2,5 mm² - AWG 24 - 14
- terminal screw torque: 0,5 Nm (4.4 lb.in), for more information see page 20 and 21

CDA 32 poles connector inserts
Maximum current load derating diagram



¹⁾ for unprepared conductors



²⁾ for conductors with end sleeve ferrule



CSAH-SQUICH® 32 poles + ⊕ 16A - 250V

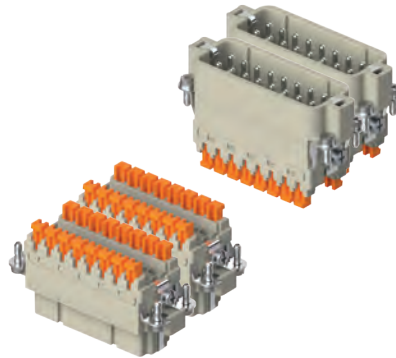
enclosures:
size "66.40"

page:

C-TYPE IP65 or IP66/IP69
W-TYPE for aggressive environments
E-Xtreme® corrosion proof

431 - 434
527
548

inserts, spring terminal connections without tools



description	part No.	part No.
-------------	----------	----------

spring terminals with actuator button
female inserts, No. (1-16) and (17-32)
male inserts, No. (1-16) and (17-32)

CSAHF 16
CSAHM 16

CSAHF 16 N
CSAHM 16 N

- characteristics according to EN 61984:

16A 250V 4kV 3

16A 400V 4kV 2

- (UL for USA and Canada),

ERC certified

- rated voltage according to UL/CSA: 600V

- insulation resistance: $\geq 10 \text{ G}\Omega$

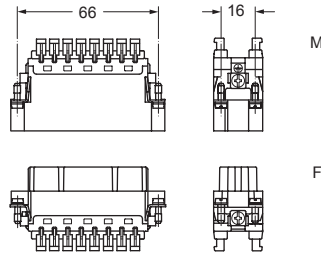
- ambient temperature limit: $-40 \text{ }^\circ\text{C} \dots +125 \text{ }^\circ\text{C}$

- made of self-extinguishing thermoplastic resin UL 94V-0

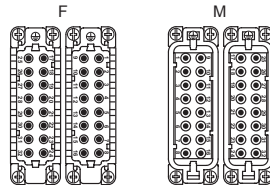
- mechanical life: ≥ 500 cycles

- contact resistance: $\leq 3 \text{ m}\Omega$

- for max. current load see the connector inserts derating diagram below; for more information see page 28



contacts side (front view)



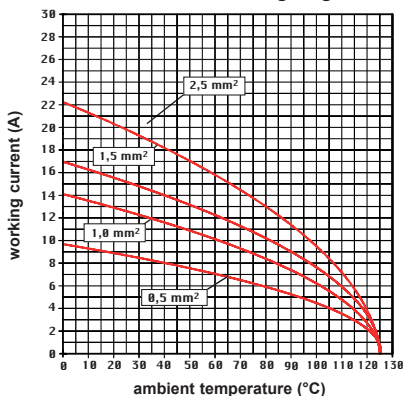
- inserts for conductors with the following sections:

0,14 - 2,5 mm² - AWG 26 - 14

- for wires with crimped ferrule, usable section:
up to 1,5 mm² (AWG 16)

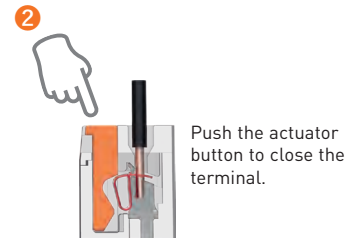
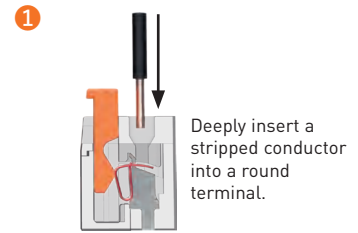
- conductors stripping length: 9...11 mm

CSAH 32 poles connector inserts
Maximum current load derating diagram

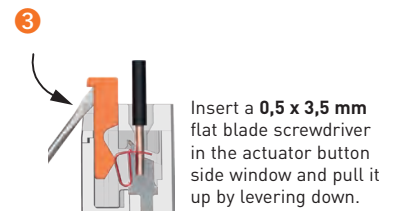


SQUICH®-spring connection technology

WIRING



RE-OPENING



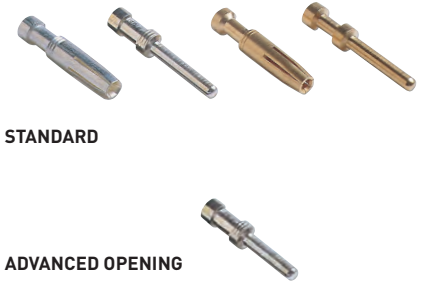
CDC 10 poles + ⊕ 16A - 250V

enclosures: size "49.16"	page:
IL-BRID	374 - 377, 382
CZ7 IP67, single lever	384
W-TYPE for aggressive environments	519
E-Xtreme® corrosion proof	540
EMC	576
panel supports: COB + adaptor	page: 652 - 654

inserts, crimp connections



16A crimp contacts
standard or for advanced opening
silver and gold plated

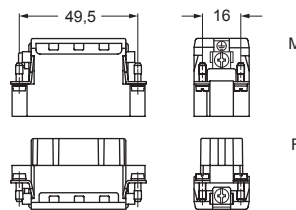


STANDARD

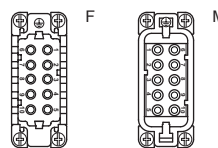
ADVANCED OPENING

description	part No.	part No.	part No.
without contacts (to be ordered separately)			
female inserts for female contacts	CDCF 10		
male inserts for male contacts	CDCM 10		
16A female contacts			
0,14-0,37 mm ² AWG 26-22 one groove		CCFA 0.3	CCFD 0.3
0,5 mm ² AWG 20 with no grooves		CCFA 0.5	CCFD 0.5
0,75 mm ² AWG 18 one groove (back side)		CCFA 0.7	CCFD 0.7
1 mm ² AWG 18 one groove		CCFA 1.0	CCFD 1.0
1,5 mm ² AWG 16 two grooves		CCFA 1.5	CCFD 1.5
2,5 mm ² AWG 14 three grooves		CCFA 2.5	CCFD 2.5
3 mm ² AWG 12 one wide groove		CCFA 3.0	CCFD 3.0
4 mm ² AWG 12 with no grooves		CCFA 4.0	CCFD 4.0
16A male contacts			
0,14-0,37 mm ² AWG 26-22 one groove		CCMA 0.3	CCMD 0.3
0,5 mm ² AWG 20 with no grooves		CCMA 0.5	CCMD 0.5
0,75 mm ² AWG 18 one groove (back side)		CCMA 0.7	CCMD 0.7
1 mm ² AWG 18 one groove		CCMA 1.0	CCMD 1.0
1,5 mm ² AWG 16 two grooves		CCMA 1.5	CCMD 1.5
2,5 mm ² AWG 14 three grooves		CCMA 2.5	CCMD 2.5
3 mm ² AWG 12 one wide groove		CCMA 3.0	CCMD 3.0
4 mm ² AWG 12 with no grooves		CCMA 4.0	CCMD 4.0
16A male crimp contacts for advanced opening			
0,5 mm ² AWG 20 with no grooves		CC 0.5 AN	* for basic or high thickness gold plating, please refer to page 675
0,75 mm ² AWG 18 one groove (back side)		CC 0.7 AN	
1 mm ² AWG 18 one groove		CC 1.0 AN	
1,5 mm ² AWG 16 two grooves		CC 1.5 AN	
2,5 mm ² AWG 14 three grooves		CC 2.5 AN	

- characteristics according to EN 61984:
16A 250V 4kV 3
16A 230/400V 4kV 2
- cULus (UL for USA and Canada),
- certified
- rated voltage according to UL/CSA: 600V
- insulation resistance: ≥ 10 GΩ
- ambient temperature limit: -40 °C ... +125 °C
- made of self-extinguishing thermoplastic resin UL 94V-0
- mechanical life: ≥ 500 cycles
- contact resistance: ≤ 1 mΩ
- according to recommendations EUROMAP N° 16
- for max. current load see the connector inserts derating diagram below; for more information see page 28

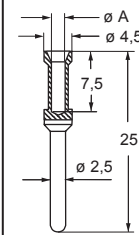


contacts side (front view)

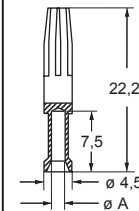
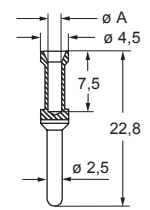


- it is recommended to crimp the contacts with crimping tools homologated by ILME (please see the crimping tool section 16A contacts, CCF, CCM and CC...AN series on pages 708 - 741)

CCF and CCM

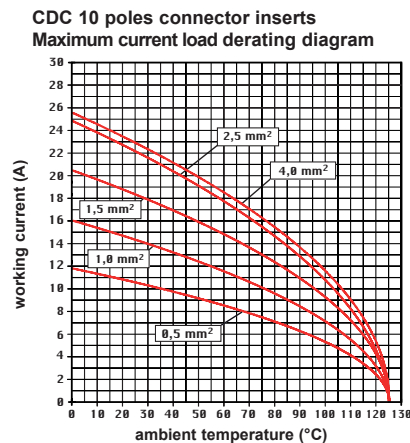


CC...AN



CCF, CCM and CC...AN contacts

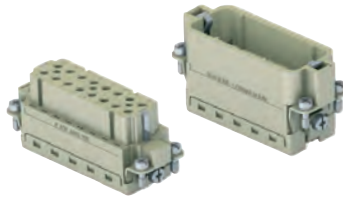
conductor section mm ²	conductor slot $\varnothing A$ (mm)	conductors stripping length (mm)
0,14-0,37	0,9	7,5
0,5	1,1	7,5
0,75	1,3	7,5
1,0	1,45	7,5
1,5	1,8	7,5
2,5	2,2	7,5
3	2,55	7,5
4	2,85	7,5



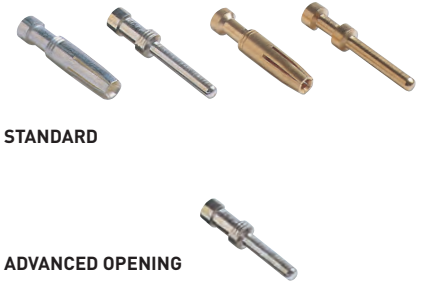
CDC 16 poles + ⊕ 16A - 250V

enclosures: size "66.16"	page:
IL-BRID	378 - 382
CZ7 IP67, single lever	385
W-TYPE for aggressive environments	520
E-Xtreme® corrosion proof	541
EMC	577
panel supports: COB + adaptor	page: 652 - 654

inserts, crimp connections



16A crimp contacts
standard or for advanced opening
silver and gold plated



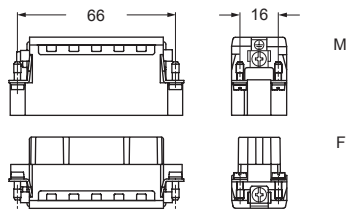
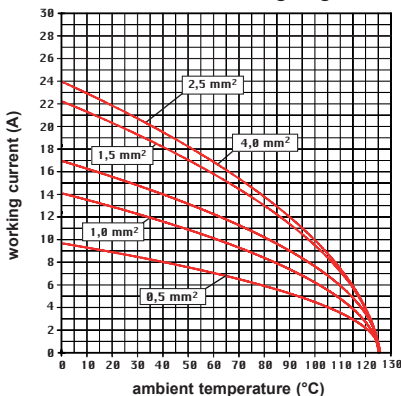
STANDARD

ADVANCED OPENING

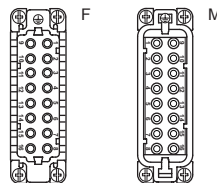
description	part No.	part No.	part No.
without contacts (to be ordered separately)			
female inserts for female contacts	CDCF 16		
male inserts for male contacts	CDCM 16		
16A female contacts			
0,14-0,37 mm ² AWG 26-22 one groove		CCFA 0.3	CCFD 0.3
0,5 mm ² AWG 20 with no grooves		CCFA 0.5	CCFD 0.5
0,75 mm ² AWG 18 one groove (back side)		CCFA 0.7	CCFD 0.7
1 mm ² AWG 18 one groove		CCFA 1.0	CCFD 1.0
1,5 mm ² AWG 16 two grooves		CCFA 1.5	CCFD 1.5
2,5 mm ² AWG 14 three grooves		CCFA 2.5	CCFD 2.5
3 mm ² AWG 12 one wide groove		CCFA 3.0	CCFD 3.0
4 mm ² AWG 12 with no grooves		CCFA 4.0	CCFD 4.0
16A male contacts			
0,14-0,37 mm ² AWG 26-22 one groove		CCMA 0.3	CCMD 0.3
0,5 mm ² AWG 20 with no grooves		CCMA 0.5	CCMD 0.5
0,75 mm ² AWG 18 one groove (back side)		CCMA 0.7	CCMD 0.7
1 mm ² AWG 18 one groove		CCMA 1.0	CCMD 1.0
1,5 mm ² AWG 16 two grooves		CCMA 1.5	CCMD 1.5
2,5 mm ² AWG 14 three grooves		CCMA 2.5	CCMD 2.5
3 mm ² AWG 12 one wide groove		CCMA 3.0	CCMD 3.0
4 mm ² AWG 12 with no grooves		CCMA 4.0	CCMD 4.0
16A male crimp contacts for advanced opening			
0,5 mm ² AWG 20 with no grooves		CC 0.5 AN	* for basic or high thickness gold plating, please refer to page 675
0,75 mm ² AWG 18 one groove (back side)		CC 0.7 AN	
1 mm ² AWG 18 one groove		CC 1.0 AN	
1,5 mm ² AWG 16 two grooves		CC 1.5 AN	
2,5 mm ² AWG 14 three grooves		CC 2.5 AN	

- characteristics according to EN 61984:
16A 250V 4kV 3
16A 230/400V 4kV 2
- (UL for USA and Canada),
-
- rated voltage according to UL/CSA: 600V
- insulation resistance: ≥ 10 GΩ
- ambient temperature limit: -40 °C ... +125 °C
- made of self-extinguishing thermoplastic resin UL 94V-0
- mechanical life: ≥ 500 cycles
- contact resistance: ≤ 1 mΩ
- according to recommendations EUROMAP N° 13 / N° 14.1
- for max. current load see the connector inserts derating diagram below; for more information see page 28

CDC 16 poles connector inserts
Maximum current load derating diagram

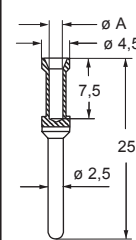


contacts side (front view)

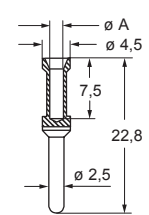


- it is recommended to crimp the contacts with crimping tools homologated by ILME (please see the crimping tool section 16A contacts, CCF, CCM and CC...AN series on pages 708 - 741)

CCF and CCM



CC...AN



CCF, CCM and CC...AN contacts

conductor section mm ²	conductor slot $\varnothing A$ (mm)	conductors stripping length (mm)
0,14-0,37	0,9	7,5
0,5	1,1	7,5
0,75	1,3	7,5
1,0	1,45	7,5
1,5	1,8	7,5
2,5	2,2	7,5
3	2,55	7,5
4	2,85	7,5

CDC 32 poles + ⊕ 16A - 250V

enclosures:
size "66.40"

page:

C-TYPE IP65 or IP66/IP69
W-TYPE for aggressive environments
E-Xtreme® corrosion proof

431 - 434
527
548

inserts, crimp connections



16A crimp contacts standard or for advanced opening silver and gold plated



STANDARD

ADVANCED OPENING

description	part No.	part No.	part No.	part No.
without contacts (to be ordered separately)				
female inserts, No. (1-16) and (17-32)	CDCF 16	CDCF 16 N		
male inserts, No. (1-16) and (17-32)	CDCM 16	CDCM 16 N		
16A female contacts				
0,14-0,37 mm ² AWG 26-22 one groove			CCFA 0.3	CCFD 0.3
0,5 mm ² AWG 20 with no grooves			CCFA 0.5	CCFD 0.5
0,75 mm ² AWG 18 one groove (back side)			CCFA 0.7	CCFD 0.7
1 mm ² AWG 18 one groove			CCFA 1.0	CCFD 1.0
1,5 mm ² AWG 16 two grooves			CCFA 1.5	CCFD 1.5
2,5 mm ² AWG 14 three grooves			CCFA 2.5	CCFD 2.5
3 mm ² AWG 12 one wide groove			CCFA 3.0	CCFD 3.0
4 mm ² AWG 12 with no grooves			CCFA 4.0	CCFD 4.0
16A male contacts				
0,14-0,37 mm ² AWG 26-22 one groove			CCMA 0.3	CCMD 0.3
0,5 mm ² AWG 20 with no grooves			CCMA 0.5	CCMD 0.5
0,75 mm ² AWG 18 one groove (back side)			CCMA 0.7	CCMD 0.7
1 mm ² AWG 18 one groove			CCMA 1.0	CCMD 1.0
1,5 mm ² AWG 16 two grooves			CCMA 1.5	CCMD 1.5
2,5 mm ² AWG 14 three grooves			CCMA 2.5	CCMD 2.5
3 mm ² AWG 12 one wide groove			CCMA 3.0	CCMD 3.0
4 mm ² AWG 12 with no grooves			CCMA 4.0	CCMD 4.0
16A male crimp contacts for advanced opening				
0,5 mm ² AWG 20 with no grooves			CC 0.5 AN	* for basic or high thickness gold plating, please refer to page 675
0,75 mm ² AWG 18 one groove (back side)			CC 0.7 AN	
1 mm ² AWG 18 one groove			CC 1.0 AN	
1,5 mm ² AWG 16 two grooves			CC 1.5 AN	
2,5 mm ² AWG 14 three grooves			CC 2.5 AN	

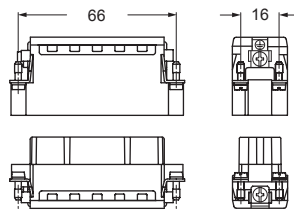
- characteristics according to EN 61984:

16A 250V 4kV 3
16A 230/400V 4kV 2

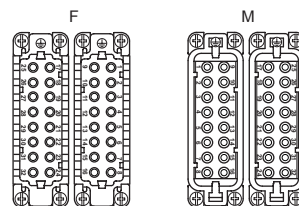
- cULus (UL for USA and Canada),

certified

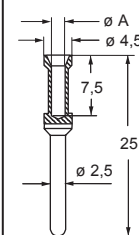
- rated voltage according to UL/CSA: 600V
- insulation resistance: ≥ 10 G Ω
- ambient temperature limit: -40 °C ... +125 °C
- made of self-extinguishing thermoplastic resin UL 94V-0
- mechanical life: ≥ 500 cycles
- contact resistance: ≤ 1 m Ω
- according to recommendations EUROMAP N° 12 / N° 62
- for max. current load see the connector inserts derating diagram below; for more information see page 28



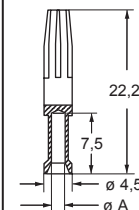
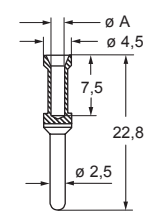
contacts side (front view)



CCF and CCM



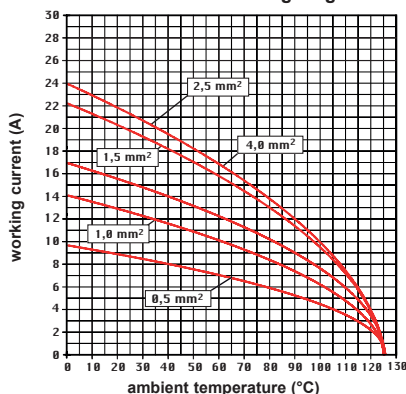
CC...AN



CCF, CCM and CC...AN contacts

conductor section mm ²	conductor slot Ø A (mm)	conductors stripping length (mm)
0,14-0,37	0,9	7,5
0,5	1,1	7,5
0,75	1,3	7,5
1,0	1,45	7,5
1,5	1,8	7,5
2,5	2,2	7,5
3	2,55	7,5
4	2,85	7,5

CDC 32 poles connector inserts
Maximum current load derating diagram



- it is recommended to crimp the contacts with crimping tools homologated by ILME (please see the crimping tool section 16A contacts, CCF, CCM and CC...AN series on pages 708 - 741)

CNE - CNE...RY series

CNE series

CNE Series are the evolution of former series CN, one of the oldest and most successful heavy-duty multipole connection products of ILME. The evolution consisted in the complete overhauling of the connector bodies, the introduction of a **captive stainless steel protection plate for unprepared conductor strands** in the screw terminals, the adoption of galvanized steel terminal screws and the **increase of the rated voltage from former 400V to 500V**.

The ancestor series CN was intermateable with the German industry standard design with screw-type terminals, for **16A** rated current per pole and solid pins Ø 2,5 mm. The two larger sizes of this series – ILME designation “77.27” for **16 P + PE** and “104.27” for **24 P + PE** – share the dimensions of a similarly old and very popular series (series **CD** in this catalogue) dimensionally standardized by the historic standards of series **DIN 43652**, later replaced by **EN 175 301-801**. The lower sizes “44.27” for **6 P + PE** and “57.27” for **10 P + PE** were proportionally scaled down from the above mentioned larger sizes.

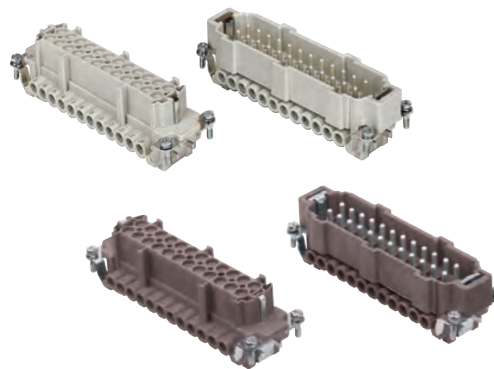
CNE connectors series come in two main variants:

- with pressure (protection) plate, **for unprepared conductors**, to preserve conductor strands from being cut from the screw head, or
- without pressure (protection) plate **[suffix X]**, for **prepared conductors** (crimped with insulated or non-insulated wire ferrule of suitable size).

Q NOTE – Prepared conductors in principle do not need any pressure (protection) plate. Use of prepared conductors is possible – although with no added value – also for CNE with pressure plate, but the highest conductor cross-sectional area 4 mm² / 12 AWG can be used only unprepared.

CNE series connection technology is **screw-type**, requiring very simple and popular tools, like a 0,8x4 mm flat blade screwdriver or a Ph0 cross-headed screwdriver (torque to apply 0,5 Nm). All connectors series CNE have their contact holder (wiring side) duly cone shaped around each terminal cavity to securely guide all stranded wires inside the terminal seat. Terminal screw are unlosably retained in their seats.

All terminals are presented completely open (unscrewed), ready to be wired, to allow spare of assembly time. The PE terminal is also screw-type (M4 screw with pressure plate, torque to apply 1,2 Nm) and is located on the mounting bracket on the pole #1 side. It covers the same conductor cross-sectional area range of the line terminals. Due to its design, the PE terminal allows two conductors per terminal (one on each side of the M4 screw); in such case it is recommended that these conductors are of the same size. Series CNE connectors are **polarized against 180° incorrect mating** by a system of keys and keyways along the contour of their mating faces.



CNE...RY variant

By partial or total replacement of the four M3 fixing screws, CNE connectors series may also use three different series of **coding and guide pins** to implement, e.g. in case of multiple identical connectors installed side by side, an “idiot-proof” system to avoid mating mismatches with counterpart.

Q NOTE – Coding may be obtained respectively by using: **CR 20 or CR 20 D single coding pins**, for up to 6 different codings, **CRF / CRM or CRF D / CRM D double coding and guide pins**, for up to 16 different codings, and the previous **double coding and guide pins plus a third element CR 72 or CR 72 D**, to allow up to 72 different coding combinations.

Connectors series CNE come in four sizes:

- size “44.27” 6 P + ⊕
- size “57.27” 10 P + ⊕
- size “77.27” 16 P + ⊕
- size “104.27” 24 P + ⊕

Two inserts – one with suffix **N** to denote special numbering, respectively CNEF/M 16 TN (or TXN) with pole numbering 17 to 32, CNEF/M 24 TN (or TXN) with numbering 25 to 48 – can be used with connector enclosures sized “77.62” or “104.62” to provide:

- size “77.62” 32 P + ⊕
- size “104.62” 48 P + ⊕

CNE...RY series for high temperatures

CNE series are available also in the **CNE...RY variant for use at high ambient temperatures up to 180 °C**.

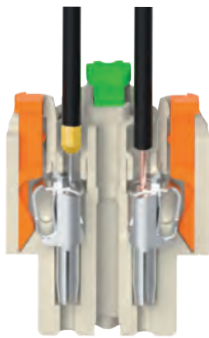
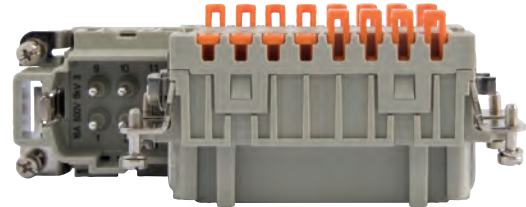
Thanks to a specific thermoplastic insulating material (whose natural colour is brown) and in combination with the dedicated connector enclosures “R-Type” for 180 °C temperature withstand, these multipole connectors are particularly suitable for installation in places in proximity of heat sources such as near ovens, moulds for thermoplastic or rubber moulding, moulds in foundries, paint booths, etc.

CSH-SQUICH® series

CSH-SQUICH® series

Spring connection with actuator button

In this view the wires are connected to the insert contacts by means of a spring terminal with actuator button.



CSH-SQUICH® INSERTS SUM-UP

- ☑ No special wire preparation (other than stripping)
- ☑ No wiring tool is necessary
- ☑ It offers an excellent fastening solution and a great resistance to strong vibrations;
- ☑ It allows solid and flexible wires with sections between 0,14 and 2,5 mm² (26-14 AWG) to be used (both with non-prepared conductors and those prepared with ferrule)
- ☑ It greatly reduces insert preparation and cabling times
- ☑ Built-in silver plated contacts

Shaped button for measuring instruments

The profile of the button used in the **SQUICH®** series inserts **allow a measuring probe to be inserted.**

This allows checks to be carried out to ensure that the wiring is correct.

Simple terminal reopening

To reopen the terminals, simply introduce the tip of a common 0,5 x 3,5 mm flat blade screwdriver in the shaped pocket on the head of the actuator, and slightly rotate the screwdriver downwards: this will lift the actuator into its open terminal position.



“Just push”
discover all the advantages
of the SQUICH® technology

CNE and CSH-SQUICH® series

TECHNICAL FEATURES

Insert series		CNE (with pressure plate) CNE...X (w/o pressure plate) CNE...RY (for high temperature)	CSH-SQUICH®
No. of poles ¹⁾	Main contacts + ⊕	6, 10, 16, 24, (32 = 2x16) (48 = 2x24)	
	auxiliary contacts	—	
Rated current ²⁾		16A	
EN IEC 61984 Pollution degree 3	rated voltage	500V	
	rated impulse voltage	6kV	
	pollution degree	3	
EN IEC 61984 Pollution degree 2	rated voltage	400/690V	
	rated impulse voltage	6kV	
	pollution degree	2	
UL / CSA certification	rated voltage (a.c./d.c.)	600V	
Contact resistance		≤ 1 mΩ	≤ 3 mΩ
Insulation resistance		≥ 10 GΩ	
Ambient temperature limit (°C)	min	-40 °C	-40 °C
	max	+125 °C / +180 °C (CNE...RY)	+125 °C
Degree of protection	with enclosures (according to type)	IP65, IP66/IP69, IP66/IP67/IP69, IP66/IP68/IP69	
	without enclosures (in mated condition) - termination side on male and female inserts - mating side on female inserts	IP20 (IPXXB)	
Conductor connections		screw type	spring and clamp with actuator button
Conductor cross-sectional area	mm ²	0,5 - 4 (CNE)	0,14 - 2,5
		0,25 - 2,5 (CNE...X)	
	AWG	20 - 12 (CNE) 24 - 14 (CNE...X)	26 - 14
Mechanical endurance (mating cycles)		≥ 500	

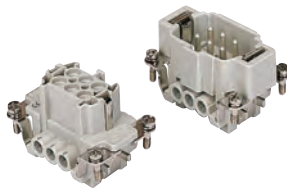
1) Polarities shown in brackets may be obtained by using two inserts in their own double-sized housings

2) Please check the inserts derating diagrams to establish the actual maximum operating current according to the ambient temperature, the conductor cross-sectional area, the polarity of the connector, and any external constraint may derive e.g. by the continuous operating temperature sustained by the chosen conductor sheathing or by end-product safety standards fixing max allowed temperature rise on terminals (e.g. 30 K, 45 K or 50 K)

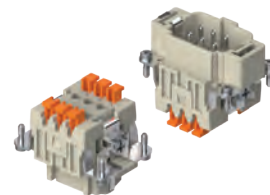
CNE CSH-SQUICH® 6 poles + ⊕ 16A - 500V

enclosures: size "44.27"	page:
C-TYPE IP65 or IP66/IP69	387 - 392
C7 IP67, single lever	436 - 437
V-TYPE IP65 or IP66/IP69, single lever	444 - 447
BIG hoods	466 - 467
T-TYPE IP65 insulating	480 - 481
T-TYPE / W IP66/IP69 insulating	489
HYGIENIC T-TYPE / H IP66/IP69	501
HYGIENIC T-TYPE / C IP66/IP69, -50 °C	506
W-TYPE for aggressive environments	521
E-Xtreme® corrosion proof	530 - 531, 542, 550 - 551
EMC	578
Central lever	603 - 605
LS-TYPE	618 - 619
IP68	632 - 635
panel supports: COB	page: 652 - 653

inserts, screw terminal connections

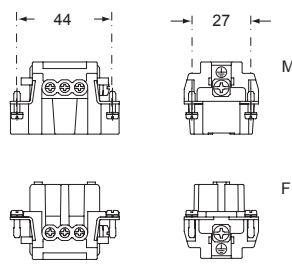
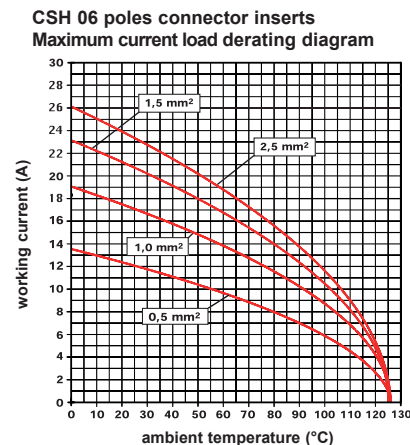
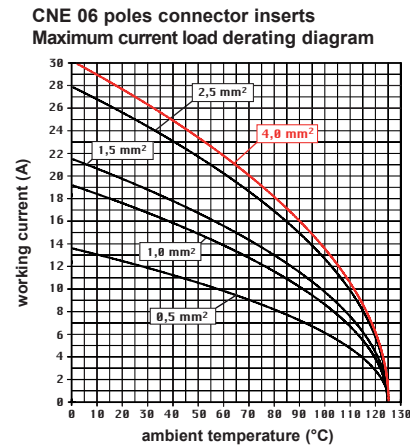


inserts, spring terminal connections without tools

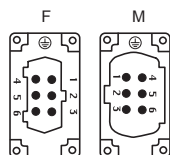


description	part No.	part No.
indirect, with plate ¹⁾ female inserts with female contacts male inserts with male contacts	CNEF 06 T CNEM 06 T	
direct, without plate ²⁾ female inserts with female contacts male inserts with male contacts	CNEF 06 TX CNEM 06 TX	
spring terminals with actuator button female inserts with female contacts male inserts with male contacts		CSHF 06 CSHM 06

- characteristics according to EN 61984:
16A 500V 6kV 3
16A 400/690V 6kV 2
- (UL for USA and Canada),
- certified
- rated voltage according to UL/CSA: 600V
- insulation resistance: ≥ 10 GΩ
- ambient temperature limit: -40 °C ... +125 °C
- made of self-extinguishing thermoplastic resin UL 94V-0
- mechanical life: ≥ 500 cycles
- contact resistance: ≤ 1 mΩ (CNE) - ≤ 3 mΩ (CSH)
- for max. current load see the connector inserts derating diagrams below; for more information see page 28



contacts side (front view)

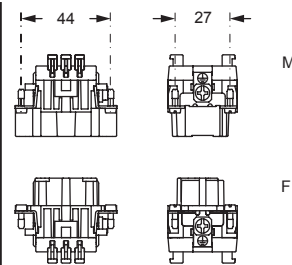


- inserts with plate for section conductors:
0,5 - 4 mm² - AWG 20 - 12
- inserts without plate for section conductors:
0,25 - 2,5 mm² - AWG 24 - 14
- conductors stripping length: 7 mm
- terminal screw torque: 0,5 Nm (4.4 lb.in), for more information see page 20 and 21

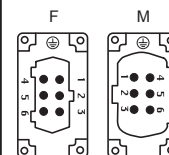
¹⁾ for unprepared conductors



²⁾ for conductors with end sleeve ferrule

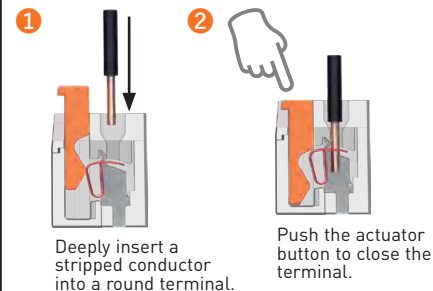


contacts side (front view)



- inserts for conductors with the following sections:
0,14 - 2,5 mm² - AWG 26 - 14
- conductors stripping length: 9...11 mm

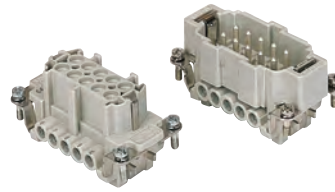
SQUICH®-spring connection technology WIRING



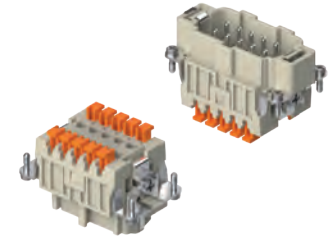
CNE CSH-SQUICH® 10 poles + ⊕ 16A - 500V

enclosures: size "57.27"	page:
C-TYPE IP65 or IP66/IP69	393 - 401
C7 IP67, two levers	438
V-TYPE IP65 or IP66/IP69, single lever	448 - 453
BIG hoods	468 - 469
T-TYPE IP65 insulating	482 - 483
T-TYPE / W IP66/IP69 insulating	490
HYGIENIC T-TYPE / H IP66/IP69	502
HYGIENIC T-TYPE / C IP66/IP69, -50 °C	507
W-TYPE for aggressive environments	522
E-Xtreme® corrosion proof	532 - 533, 543, 552 - 553
EMC	579
Central lever	606 - 608
LS-TYPE	620 - 621
IP68	636 - 639
panel supports: COB	page: 652 - 653

inserts, screw terminal connections

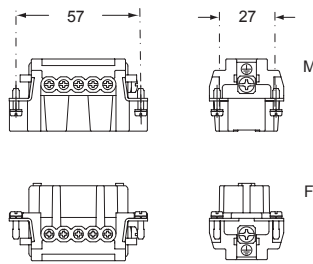


inserts, spring terminal connections without tools

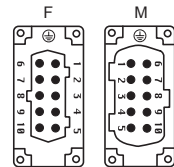


description	part No.	part No.
indirect, with plate ¹⁾ female inserts with female contacts male inserts with male contacts	CNEF 10 T CNEM 10 T	
direct, without plate ²⁾ female inserts with female contacts male inserts with male contacts	CNEF 10 TX CNEM 10 TX	
spring terminals with actuator button female inserts with female contacts male inserts with male contacts		CSHF 10 CSHM 10

- characteristics according to EN 61984:
16A 500V 6kV 3
16A 400/690V 6kV 2
- (UL for USA and Canada), certified
- rated voltage according to UL/CSA: 600V
- insulation resistance: ≥ 10 GΩ
- ambient temperature limit: -40 °C ... +125 °C
- made of self-extinguishing thermoplastic resin UL 94V-0
- mechanical life: ≥ 500 cycles
- contact resistance: ≤ 1 mΩ (CNE) - ≤ 3 mΩ (CSH)
- for max. current load see the connector inserts derating diagrams below; for more information see page 28



contacts side (front view)

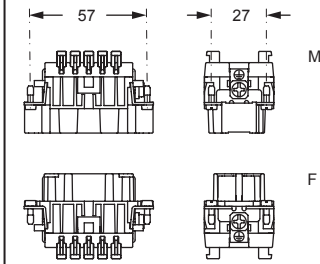


- inserts with plate for section conductors: 0,5 - 4 mm² - AWG 20 - 12
- inserts without plate for section conductors: 0,25 - 2,5 mm² - AWG 24 - 14
- conductors stripping length: 7 mm
- terminal screw torque: 0,5 Nm (4.4 lb.in), for more information see page 20 and 21

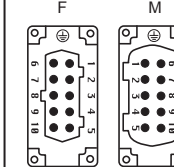
¹⁾ for unprepared conductors



²⁾ for conductors with end sleeve ferrule

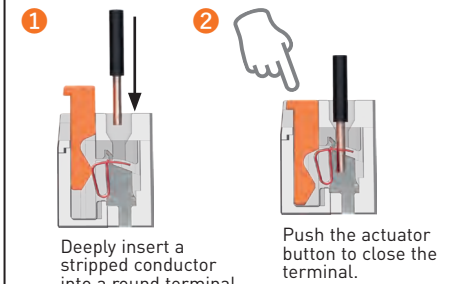


contacts side (front view)

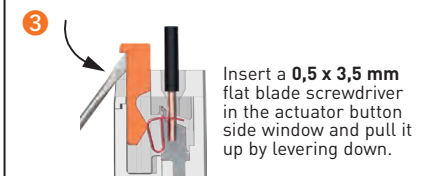


- inserts for conductors with the following sections: 0,14 - 2,5 mm² - AWG 26 - 14
- conductors stripping length: 9...11 mm

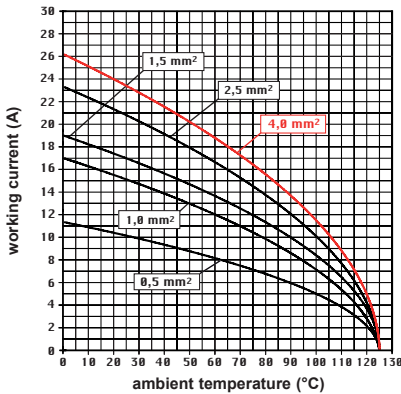
SQUICH®-spring connection technology WIRING



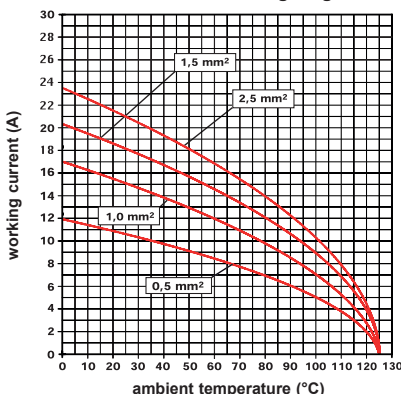
RE-OPENING



CNE 10 poles connector inserts Maximum current load derating diagram



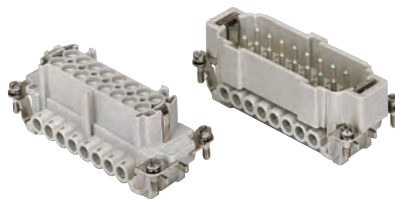
CSH 10 poles connector inserts Maximum current load derating diagram



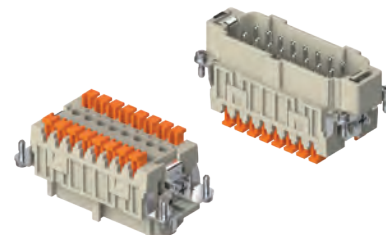
CNE CSH-SQUICH® 16 poles + ⊕ 16A - 500V

enclosures: size "77.27"	page:
C-TYPE IP65 or IP66/IP69	402 - 411
C7 IP67, two levers	439 - 440
V-TYPE IP65 or IP66/IP69, single lever	454 - 458
BIG hoods	470 - 471
T-TYPE IP65 insulating	484 - 485
T-TYPE / W IP66/IP69 insulating	491
HYGIENIC T-TYPE / H IP66/IP69	503
HYGIENIC T-TYPE / C IP66/IP69, -50 °C	508
W-TYPE for aggressive environments	523
E-Xtreme® corrosion proof	534 - 535, 544, 554 - 555
EMC	580
Central lever	609 - 611
LS-TYPE	622 - 623
IP68	640 - 643
panel supports: COB	page: 652 - 653

inserts, screw terminal connections

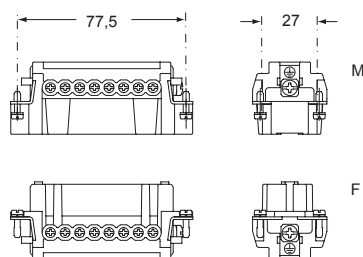


inserts, spring terminal connections without tools

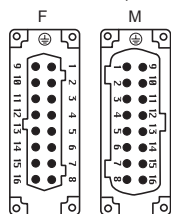


description	part No.	part No.
indirect, with plate ¹⁾ female inserts with female contacts male inserts with male contacts	CNEF 16 T CNEM 16 T	
direct, without plate ²⁾ female inserts with female contacts male inserts with male contacts	CNEF 16 TX CNEM 16 TX	
spring terminals with actuator button female inserts with female contacts male inserts with male contacts		CSHF 16 CSHM 16

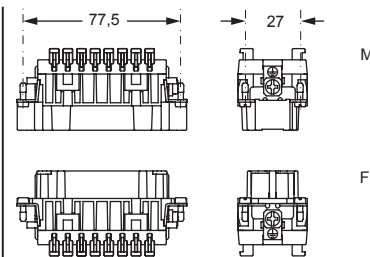
- characteristics according to EN 61984:
16A 500V 6kV 3
16A 400/690V 6kV 2
- (UL for USA and Canada), certified
- rated voltage according to UL/CSA: 600V
- insulation resistance: ≥ 10 GΩ
- ambient temperature limit: -40 °C ... +125 °C
- made of self-extinguishing thermoplastic resin UL 94V-0
- mechanical life: ≥ 500 cycles
- contact resistance: ≤ 1 mΩ (CNE) - ≤ 3 mΩ (CSH)
- for max. current load see the connector inserts derating diagrams below; for more information see page 28



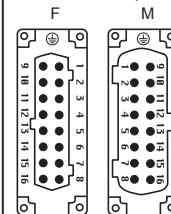
contacts side (front view)



- inserts with plate for section conductors:
0,5 - 4 mm² - AWG 20 - 12
- inserts without plate for section conductors:
0,25 - 2,5 mm² - AWG 24 - 14
- conductors stripping length: 7 mm
- terminal screw torque: 0,5 Nm (4.4 lb.in), for more information see page 20 and 21

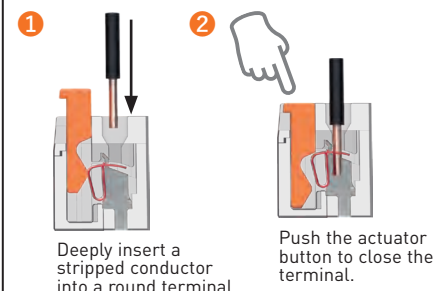


contacts side (front view)

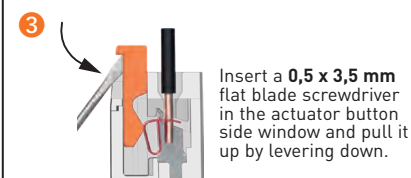


- inserts for conductors with the following sections:
0,14 - 2,5 mm² - AWG 26 - 14
- conductors stripping length: 9...11 mm

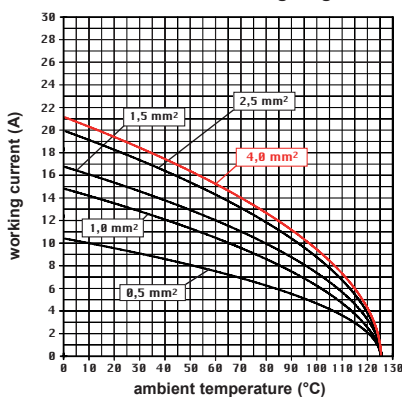
SQUICH®-spring connection technology WIRING



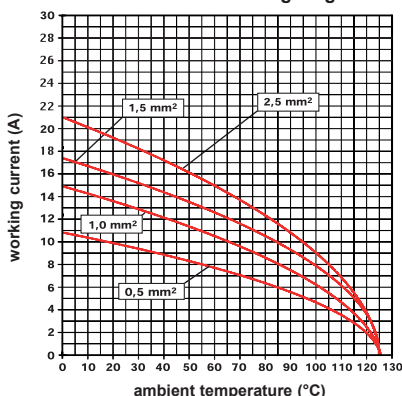
RE-OPENING



CNE 16 poles connector inserts
Maximum current load derating diagram



CSH 16 poles connector inserts
Maximum current load derating diagram



¹⁾ for unprepared conductors



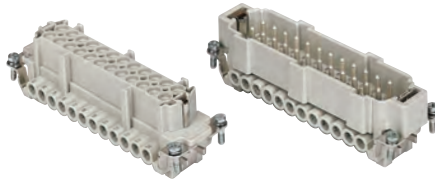
²⁾ for conductors with end sleeve ferrule



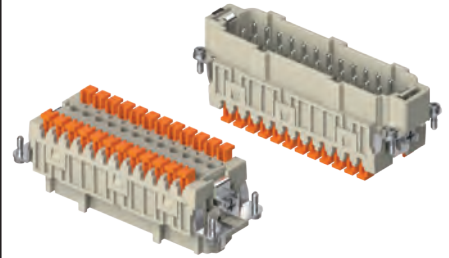
CNE CSH-SQUICH® 24 poles + ⊕ 16A - 500V

enclosures: size "104.27"	page:
C-TYPE IP65 or IP66/IP69	412 - 423
C7 IP67, two levers	441 - 442
V-TYPE IP65 or IP66/IP69, single lever	459 - 463
BIG hoods	472 - 473
T-TYPE IP65 insulating	486 - 487
T-TYPE / W IP66/IP69 insulating	492
HYGIENIC T-TYPE / H IP66/IP69	504
HYGIENIC T-TYPE / C IP66/IP69, -50 °C	509
W-TYPE for aggressive environments	524
E-Xtreme® corrosion proof	536 - 537, 545, 556 - 557
EMC	581
Central lever	612 - 614
LS-TYPE	624 - 625
IP68	644 - 647
panel supports: COB	page: 652 - 653

inserts, screw terminal connections

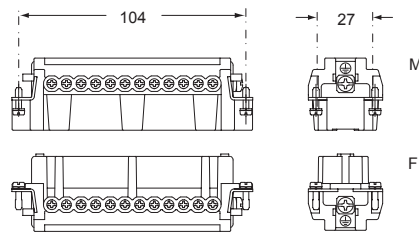


inserts, spring terminal connections without tools

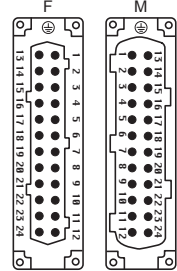


description	part No.	part No.
indirect, with plate ¹⁾ female inserts with female contacts male inserts with male contacts	CNEF 24 T CNEM 24 T	
direct, without plate ²⁾ female inserts with female contacts male inserts with male contacts	CNEF 24 TX CNEM 24 TX	
spring terminals with actuator button female inserts with female contacts male inserts with male contacts		CSHF 24 CSHM 24

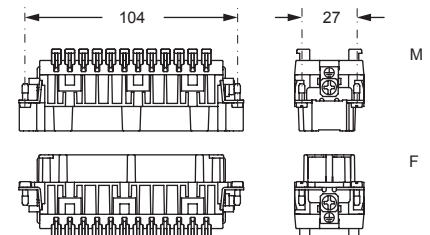
- characteristics according to EN 61984:
16A 500V 6kV 3
16A 400/690V 6kV 2
- certified
- rated voltage according to UL/CSA: 600V
- insulation resistance: ≥ 10 GΩ
- ambient temperature limit: -40 °C ... +125 °C
- made of self-extinguishing thermoplastic resin UL 94V-0
- mechanical life: ≥ 500 cycles
- contact resistance: ≤ 1 mΩ (CNE) - ≤ 3 mΩ (CSH)
- for max. current load see the connector inserts derating diagrams below; for more information see page 28



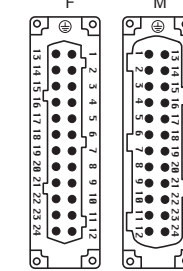
contacts side (front view)



- inserts with plate for section conductors:
0,5 - 4 mm² - AWG 20 - 12
- inserts without plate for section conductors:
0,25 - 2,5 mm² - AWG 24 - 14
- conductors stripping length: 7 mm
- terminal screw torque: 0,5 Nm (4.4 lb.in), for more information see page 20 and 21



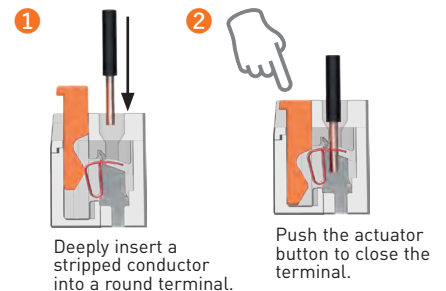
contacts side (front view)



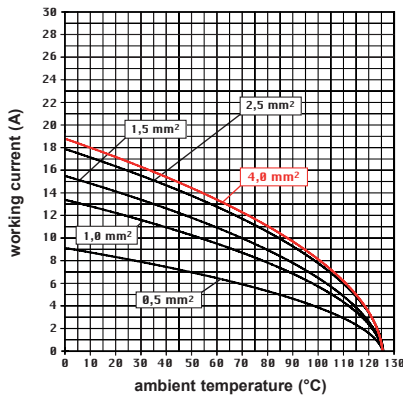
- inserts for conductors with the following sections:
0,14 - 2,5 mm² - AWG 26 - 14
- conductors stripping length: 9...11 mm

SQUICH®-spring connection technology

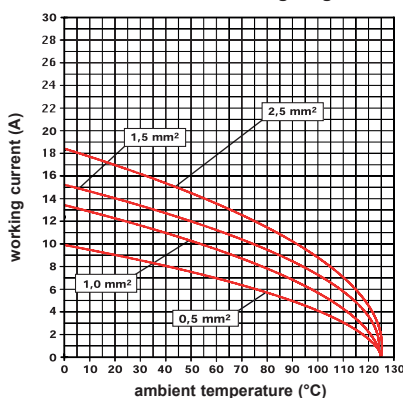
WIRING



CNE 24 poles connector inserts Maximum current load derating diagram



CSH 24 poles connector inserts Maximum current load derating diagram



CNE CSH-SQUICH® 32 poles + ⊕ 16A - 500V

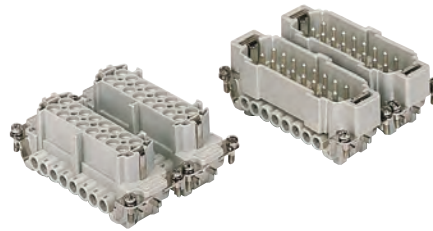
enclosures:
size "77.62"

page:

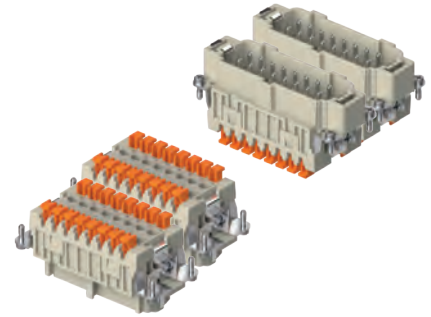
C-TYPE IP65 or IP66/IP69
W-TYPE for aggressive environments
E-Xtreme® corrosion proof

424 - 429
525
546

inserts,
screw terminal connections

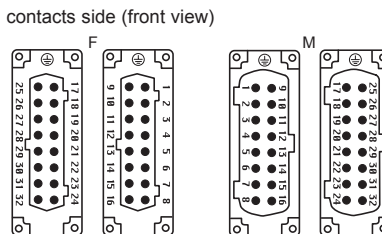
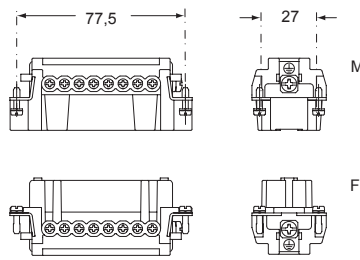


inserts,
spring terminal connections without tools

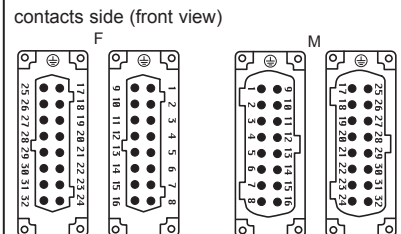
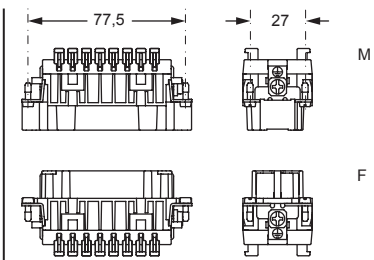


description	part No.	part No.	part No.	part No.
indirect, with plate ¹⁾ female inserts, No. (1-16) and (17-32) male inserts, No. (1-16) and (17-32)	CNEF 16 T CNEM 16 T	CNEF 16 TN CNEM 16 TN		
direct, without plate ²⁾ female inserts, No. (1-16) and (17-32) male inserts, No. (1-16) and (17-32)	CNEF 16 TX CNEM 16 TX	CNEF 16 TXN CNEM 16 TXN		
spring terminals with actuator button female inserts with female contacts, No. (1-16) and (17-32) male inserts with male contacts, No. (1-16) and (17-32)			CSHF 16 CSHM 16	CSHF 16 N CSHM 16 N

- characteristics according to EN 61984:
16A 500V 6kV 3
16A 400/690V 6kV 2
- (UL for USA and Canada),
- certified
- rated voltage according to UL/CSA: 600V
- insulation resistance: $\geq 10 \text{ G}\Omega$
- ambient temperature limit: $-40 \text{ }^\circ\text{C} \dots +125 \text{ }^\circ\text{C}$
- made of self-extinguishing thermoplastic resin UL 94V-0
- mechanical life: ≥ 500 cycles
- contact resistance: $\leq 1 \text{ m}\Omega$ (CNE) - $\leq 3 \text{ m}\Omega$ (CSH)
- for max. current load see the connector inserts derating diagrams below; for more information see page 28

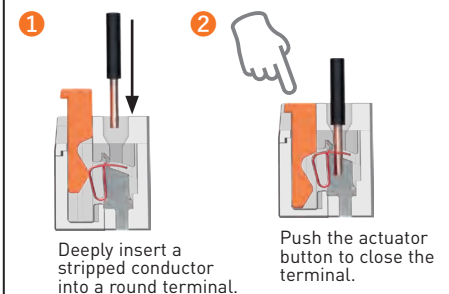


- inserts with plate for section conductors:
0,5 - 4 mm² - AWG 20 - 12
- inserts without plate for section conductors:
0,25 - 2,5 mm² - AWG 24 - 14
- conductors stripping length: 7 mm
- terminal screw torque: 0,5 Nm (4.4 lb.in), for more information see page 20 and 21

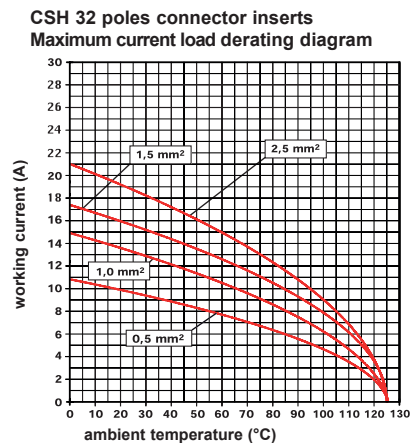
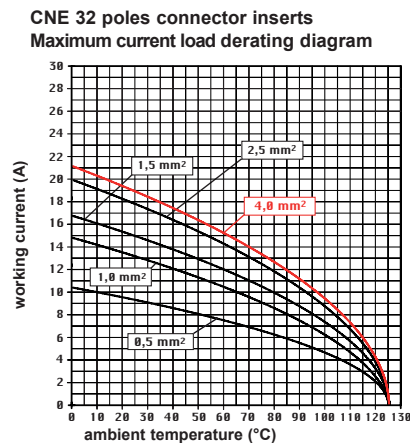
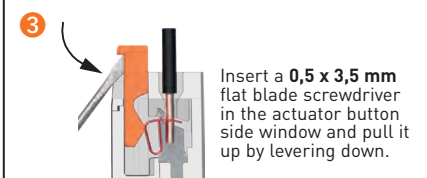


- inserts for conductors with the following sections:
0,14 - 2,5 mm² - AWG 26 - 14
- conductors stripping length: 9...11 mm

SQUICH®-spring connection technology
WIRING



RE-OPENING



¹⁾ for unprepared conductors



²⁾ for conductors with end sleeve ferrule



CNE CSH-SQUICH® 48 poles + ⊕ 16A - 500V

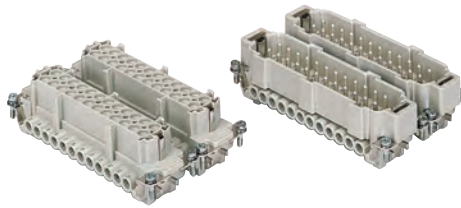
enclosures:
size "104.62"

page:

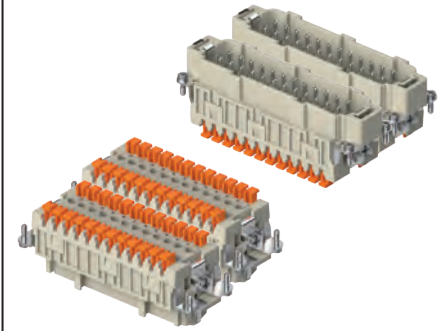
C-TYPE IP65 or IP66/IP69
W-TYPE for aggressive environments
E-Xtreme® corrosion proof

430
526
547

inserts,
screw terminal connections

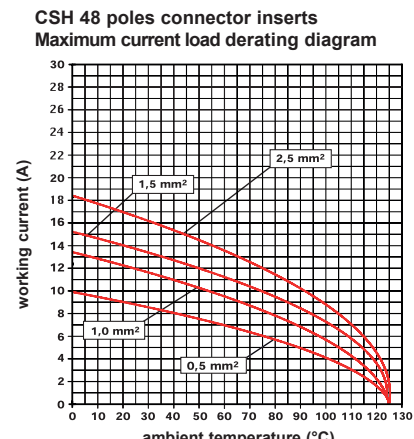
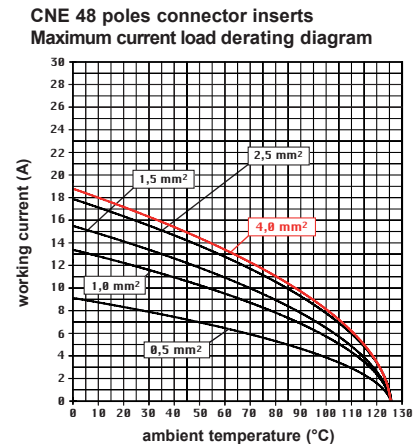
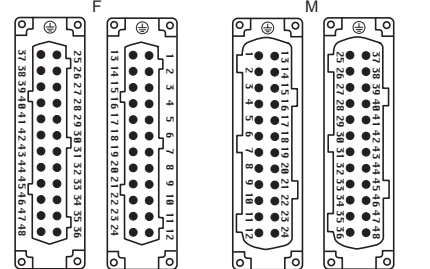
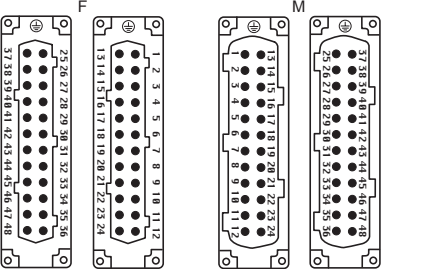
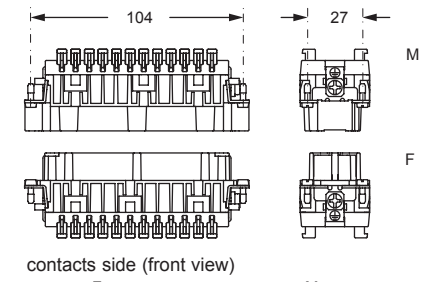
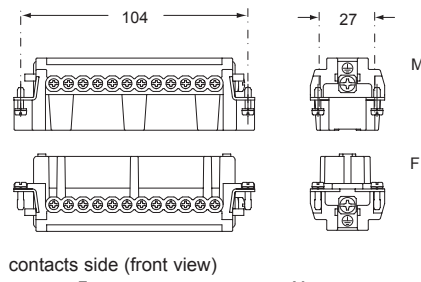


inserts,
spring terminal connections without tools



description	part No.	part No.	part No.	part No.
indirect, with plate ¹⁾ female inserts, No. (1-24) and (25-48) male inserts, No. (1-24) and (25-48)	CNEF 24 T CNEM 24 T	CNEF 24 TN CNEM 24 TN		
direct, without plate ²⁾ female inserts, No. (1-24) and (25-48) male inserts, No. (1-24) and (25-48)	CNEF 24 TX CNEM 24 TX	CNEF 24 TXN CNEM 24 TXN		
spring terminals with actuator button female inserts with female contacts, No. (1-24) and (25-48) male inserts with male contacts, No. (1-24) and (25-48)			CSHF 24 CSHM 24	CSHF 24 N CSHM 24 N

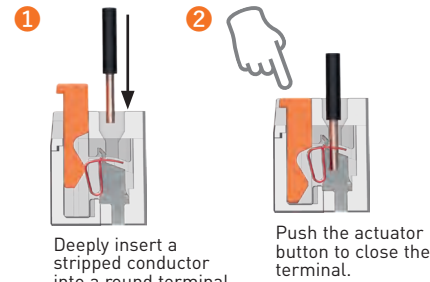
- characteristics according to EN 61984:
16A 500V 6kV 3
16A 400/690V 6kV 2
- cULus (UL for USA and Canada),
- certified
- rated voltage according to UL/CSA: 600V
- insulation resistance: ≥ 10 GΩ
- ambient temperature limit: -40 °C ... +125 °C
- made of self-extinguishing thermoplastic resin UL 94V-0
- mechanical life: ≥ 500 cycles
- contact resistance: ≤ 1 mΩ (CNE) - ≤ 3 mΩ (CSH)
- for max. current load see the connector inserts derating diagrams below; for more information see page 28



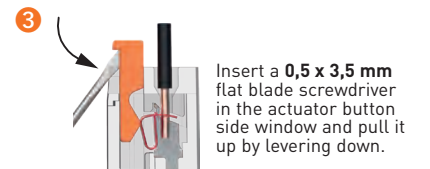
- inserts with plate for section conductors:
0,5 - 4 mm² - AWG 20 - 12
- inserts without plate for section conductors:
0,25 - 2,5 mm² - AWG 24 - 14
- conductors stripping length: 7 mm
- terminal screw torque: 0,5 Nm (4.4 lb.in), for more information see page 20 and 21

- inserts for conductors with the following sections:
0,14 - 2,5 mm² - AWG 26 - 14
- conductors stripping length: 9...11 mm

SQUICH®-spring connection technology
WIRING



RE-OPENING



¹⁾ for unprepared conductors



²⁾ for conductors with end sleeve ferrule



CNE...RY 6 poles + ⊕ 16A - 500V

enclosures:
size "44.27"

page:

for 180 °C

586

inserts,
screw terminal connections



180 °C

description

part No.

indirect, with plate ¹⁾, use in up to 180 °C
female inserts with female contacts, brown
male inserts with male contacts, brown

CNEF 06 RY
CNEM 06 RY

- characteristics according to EN 61984:

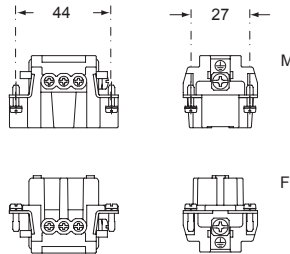
16A 500V 6kV 3

16A 400/690V 6kV 2

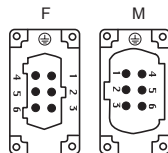
- cULus (UL for USA and Canada),

ERIC certified

- rated voltage according to UL/CSA: 600V
- insulation resistance: $\geq 10 \text{ G}\Omega$
- ambient temperature limit: -40 °C ... +180 °C
- made of self-extinguishing thermoplastic resin UL 94V-0
- mechanical life: ≥ 500 cycles
- contact resistance: $\leq 1 \text{ m}\Omega$
- for max. current load see the connector inserts derating diagram below; for more information see page 28

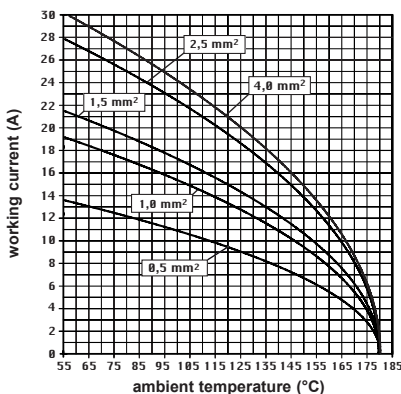


contacts side (front view)



- inserts with plate for section conductors:
0,5 - 4 mm² - AWG 20 - 12
- conductors stripping length: 7 mm
- terminal screw torque: 0,5 Nm (4,4 lb.in), for more information see page 20 and 21

CNE...RY 06 poles connector inserts
Maximum current load derating diagram



¹⁾ for unprepared conductors



CNE...RY 10 poles + ⊕ 16A - 500V

enclosures:
size "57.27"
for 180 °C

page:
587

inserts,
screw terminal connections



180 °C

description

part No.

indirect, with plate ¹⁾, use in up to 180 °C
female inserts with female contacts, brown
male inserts with male contacts, brown

CNEF 10 RY
CNEM 10 RY

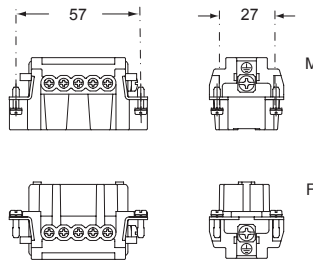
- characteristics according to EN 61984:

16A 500V 6kV 3
16A 400/690V 6kV 2

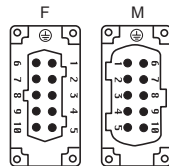
- cULus (UL for USA and Canada), SB, CEC, DNV-GL

BUREAU VERITAS EAC certified

- rated voltage according to UL/CSA: 600V
- insulation resistance: ≥ 10 GΩ
- ambient temperature limit: -40 °C ... +180 °C
- made of self-extinguishing thermoplastic resin UL 94V-0
- mechanical life: ≥ 500 cycles
- contact resistance: ≤ 1 mΩ
- for max. current load see the connector inserts derating diagram below; for more information see page 28

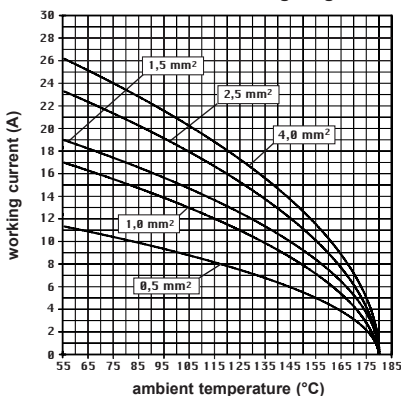


contacts side (front view)



- inserts with plate for section conductors:
0,5 - 4 mm² - AWG 20 - 12
- conductors stripping length: 7 mm
- terminal screw torque: 0,5 Nm (4,4 lb.in), for more information see page 20 and 21

CNE...RY 10 poles connector inserts
Maximum current load derating diagram



¹⁾ for unprepared conductors

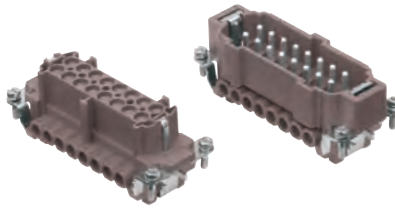


CNE...RY 16 poles + ⊕ 16A - 500V

enclosures:
size "77.27"
for 180 °C

page:
588

inserts,
screw terminal connections



180 °C

description

part No.

indirect, with plate ¹⁾, use in up to 180 °C
female inserts with female contacts, brown
male inserts with male contacts, brown

CNEF 16 RY
CNEM 16 RY

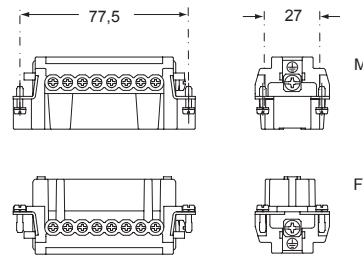
- characteristics according to EN 61984:

16A 500V 6kV 3
16A 400/690V 6kV 2

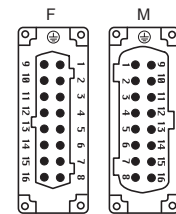
- cULus (UL for USA and Canada),

certified

- rated voltage according to UL/CSA: 600V
- insulation resistance: ≥ 10 GΩ
- ambient temperature limit: -40 °C ... +180 °C
- made of self-extinguishing thermoplastic resin UL 94V-0
- mechanical life: ≥ 500 cycles
- contact resistance: ≤ 1 mΩ
- for max. current load see the connector inserts derating diagram below; for more information see page 28



contacts side (front view)

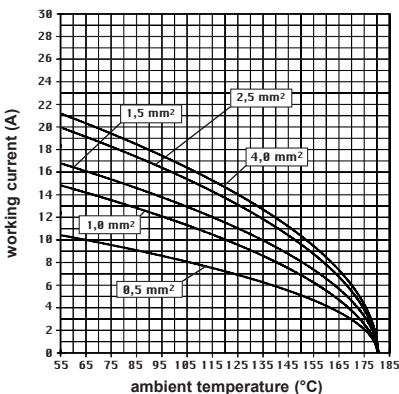


- inserts with plate for section conductors:
0,5 - 4 mm² - AWG 20 - 12
- conductors stripping length: 7 mm
- terminal screw torque: 0,5 Nm (4,4 lb.in), for more information see page 20 and 21

¹⁾ for unprepared conductors



CNE...RY 16 poles connector inserts
Maximum current load derating diagram

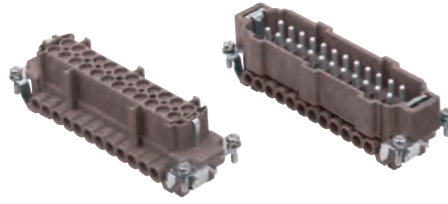


CNE...RY 24 poles + ⊕ 16A - 500V

enclosures:
size "104.27"
for 180 °C

page:
589

inserts,
screw terminal connections



180 °C

description

part No.

indirect, with plate ¹⁾, use in up to 180 °C
female inserts with female contacts, brown
male inserts with male contacts, brown

CNEF 24 RY
CNEM 24 RY

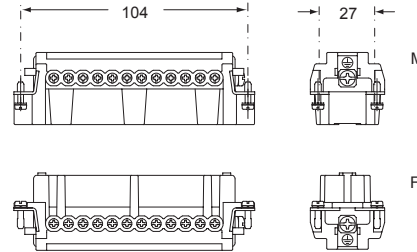
- characteristics according to EN 61984:

16A 500V 6kV 3
16A 400/690V 6kV 2

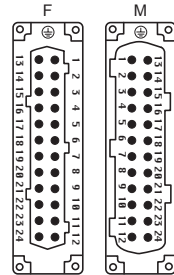
- cULus (UL for USA and Canada),

certified

- rated voltage according to UL/CSA: 600V
- insulation resistance: $\geq 10 \text{ G}\Omega$
- ambient temperature limit: -40 °C ... +180 °C
- made of self-extinguishing thermoplastic resin UL 94V-0
- mechanical life: ≥ 500 cycles
- contact resistance: $\leq 1 \text{ m}\Omega$
- for max. current load see the connector inserts derating diagram below; for more information see page 28



contacts side (front view)

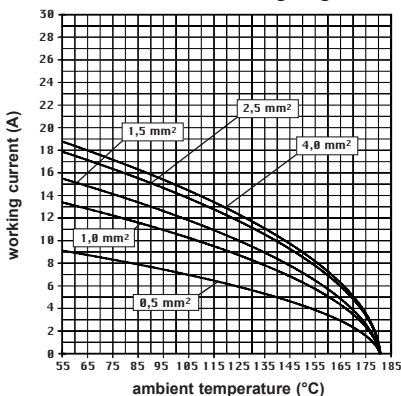


- inserts with plate for section conductors:
0,5 - 4 mm² - AWG 20 - 12
- conductors stripping length: 7 mm
- terminal screw torque: 0,5 Nm (4,4 lb.in), for more information see page 20 and 21

¹⁾ for unprepared conductors



CNE...RY 24 poles connector inserts
Maximum current load derating diagram



CNE...RY 48 poles + ⊕ 16A - 500V

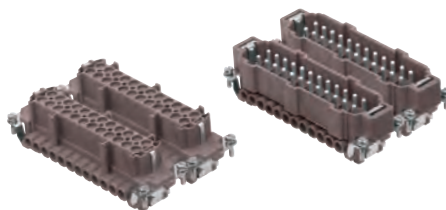
enclosures:
size "104.62"

for 180 °C

page:

590

inserts,
screw terminal connections



180 °C

description

part No.

part No.

indirect, with plate ¹⁾, use in up to 180 °C
female inserts, No. (1-24) and (25-48), brown
male inserts, No. (1-24) and (25-48), brown

CNEF 24 RY
CNEM 24 RY

CNEF 24 RYN
CNEM 24 RYN

- characteristics according to EN 61984:

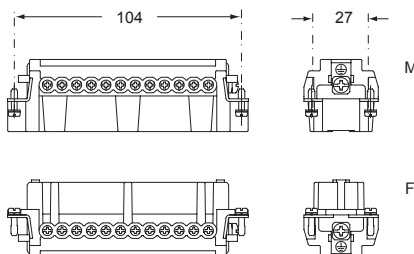
16A 500V 6kV 3

16A 400/690V 6kV 2

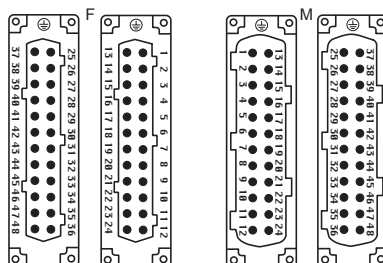
- cULus (UL for USA and Canada),

ERC certified

- rated voltage according to UL/CSA: 600V
- insulation resistance: ≥ 10 GΩ
- ambient temperature limit: -40 °C ... +180 °C
- made of self-extinguishing thermoplastic resin UL 94V-0
- mechanical life: ≥ 500 cycles
- contact resistance: ≤ 1 mΩ
- for max. current load see the connector inserts derating diagram below; for more information see page 28

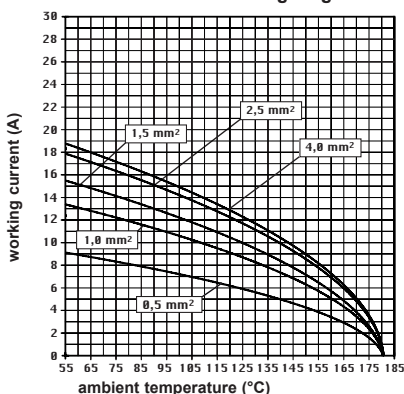


contacts side (front view)



- inserts with plate for section conductors: 0,5 - 4 mm² - AWG 20 - 12
- conductors stripping length: 7 mm
- terminal screw torque: 0,5 Nm (4,4 lb.in), for more information see page 20 and 21

CNE...RY 48 poles connector inserts
Maximum current load derating diagram



¹⁾ for unprepared conductors



CSH S-SQUICH® series

TECHNICAL FEATURES

Demand for cost-effective solutions for large serial production is constantly growing and stamped contacts meet the basic needs for such applications.

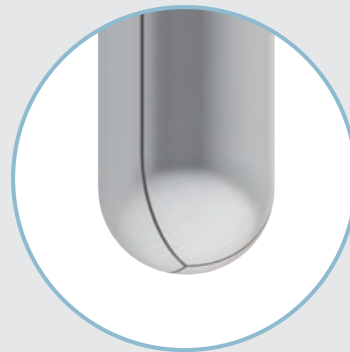
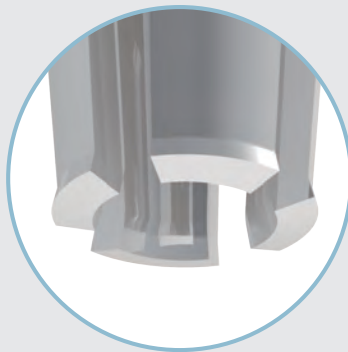
- ILME stamped contacts, thanks to their **silver-plated** treatment are suitable for up to **500 mating cycles**, consistently with the turned ones.



Q In order to easily recognize them, each insert is marked with an “S” at the end of the product code, meaning “stamped”.

- Stamped contacts applied to the SQUICH® connection feature all the well-known advantages of the ILME proprietary technology:
 - **reduced wiring time** (spring-clamp terminals are presented “open”, with the actuator button lifted up); up to **50% saving time** compared to screw connection;
 - **operator skill independence** (no need to open the spring-clamp terminals by direct operation of a possibly unsuitable tool on the spring);
 - **no special wire preparation** (only stripping at the correct length);
 - no wiring tool needed;
 - **resistance to strong vibrations** typical of the self-compensating spring-clamp technology;
 - possibility **to use solid and flexible** stranded copper conductors with range of cross sectional area between 0,14 mm² and 2,5 mm² (26 – 14 AWG);
 - possibility to insert the **test probe** of a measurement instrument in the cavity of the actuator button (proprietary design);
 - simple re-opening of a terminal (if needed) using a flat blade screwdriver on the actuator button dedicated side window.

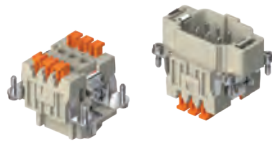
stamped
silver-plated
contacts



CSHF/M 06 S 6 poles + ⊕ 16A - 500V SQUICH®

enclosures: size "44.27"	page:
C-TYPE IP65 or IP66/IP69	387 - 392
C7 IP67, single lever	436 - 437
V-TYPE IP65 or IP66/IP69, single lever	444 - 447
BIG hoods	466 - 467
T-TYPE IP65 insulating	480 - 481
T-TYPE / W IP66/IP69 insulating	489
HYGIENIC T-TYPE / H IP66/IP69	501
HYGIENIC T-TYPE / C IP66/IP69, -50 °C	506
W-TYPE for aggressive environments	521
E-Xtreme® corrosion proof	530 - 531, 542, 550 - 551
EMC	578
Central lever	603 - 605
LS-TYPE	618 - 619
IP68	632 - 635
panel supports:	page:
COB	652 - 653

inserts, spring terminal connections



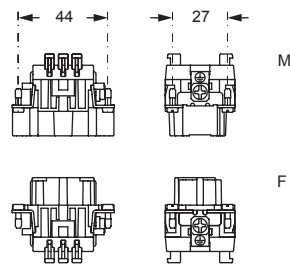
Q STAMPED CONTACTS, SILVER PLATED

description	part No.
-------------	----------

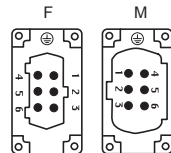
spring terminals with actuator button
female inserts with female contacts
male inserts with male contacts

CSHF 06 S
CSHM 06 S

- characteristics according to EN 61984:
16A 500V 6kV 3
16A 400/690V 6kV 2
- cULus (UL for USA and Canada) certified
CSA, CQC, DNV-GL, BV, EAC pending
- rated voltage according to UL/CSA: 600V
- insulation resistance: $\geq 10 \text{ G}\Omega$
- ambient temperature limit: $-40 \text{ }^\circ\text{C} \dots +125 \text{ }^\circ\text{C}$
- made of self-extinguishing thermoplastic resin
UL 94V-0
- mechanical life: ≥ 500 cycles
- contact resistance: $\leq 3 \text{ m}\Omega$
- for max. current load see the connector inserts derating diagram below; for more information see page 28

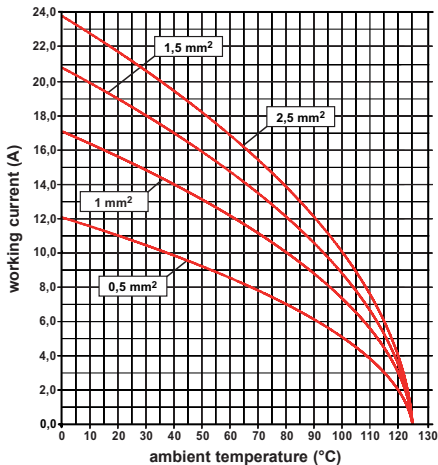


contacts side (front view)



- inserts for connectors with the following conductor cross-sectional areas: 0,14 - 2,5 mm² - AWG 26 - 14
- conductors stripping length: 9...11 mm

CSH S 06 poles connector inserts
Maximum current load derating diagram



SQUICH®-spring connection technology

WIRING

- 1** Deeply insert a stripped conductor into a round terminal.
- 2** Push the actuator button to close the terminal.

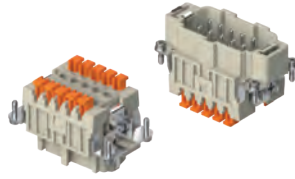
RE-OPENING

- 3** Insert a **0,5 x 3,5 mm** flat blade screwdriver in the actuator button side window and pull it up by levering down.

CSHF/M 10 S 10 poles + ⊕ 16A - 500V SQUICH®

enclosures: size "57.27"	page:
C-TYPE IP65 or IP66/IP69	393 - 401
C7 IP67, two levers	438
V-TYPE IP65 or IP66/IP69, single lever	448 - 453
BIG hoods	468 - 469
T-TYPE IP65 insulating	482 - 483
T-TYPE / W IP66/IP69 insulating	490
HYGIENIC T-TYPE / H IP66/IP69	502
HYGIENIC T-TYPE / C IP66/IP69, -50 °C	507
W-TYPE for aggressive environments	522
E-Xtreme® corrosion proof	532 - 533, 543, 552 - 553
EMC	579
Central lever	606 - 608
LS-TYPE	620 - 621
IP68	636 - 639
panel supports:	page:
COB	652 - 653

inserts, spring terminal connections



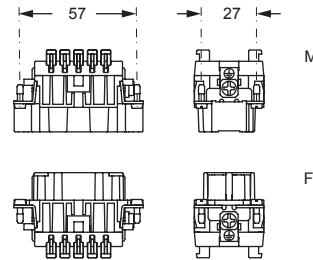
Q STAMPED CONTACTS, SILVER PLATED

description	part No.
-------------	----------

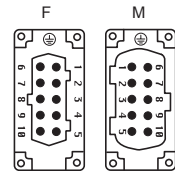
spring terminals with actuator button
female inserts with female contacts
male inserts with male contacts

CSHF 10 S
CSHM 10 S

- characteristics according to EN 61984:
16A 500V 6kV 3
16A 400/690V 6kV 2
- (UL for USA and Canada) certified
CSA, CQC, DNV-GL, BV, EAC pending
- rated voltage according to UL/CSA: 600V
- insulation resistance: $\geq 10 \text{ G}\Omega$
- ambient temperature limit: $-40 \text{ }^\circ\text{C} \dots +125 \text{ }^\circ\text{C}$
- made of self-extinguishing thermoplastic resin
UL 94V-0
- mechanical life: ≥ 500 cycles
- contact resistance: $\leq 3 \text{ m}\Omega$
- for max. current load see the connector inserts derating
diagram below; for more information see page 28

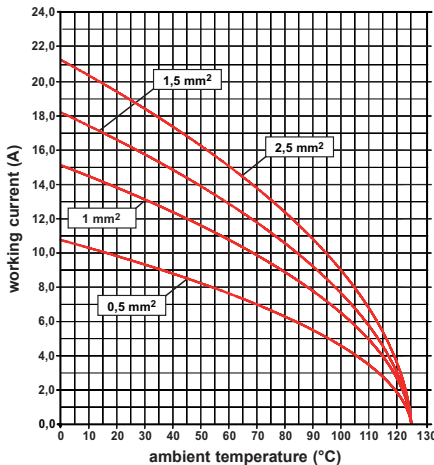


contacts side (front view)



- inserts for connectors with the following conductor
cross-sectional areas: 0,14 - 2,5 mm² - AWG 26 - 14
- conductors stripping length: 9...11 mm

CSH S 10 poles connector inserts
Maximum current load derating diagram



SQUICH®-spring connection technology

WIRING

- Deeply insert a stripped conductor into a round terminal.
- Push the actuator button to close the terminal.

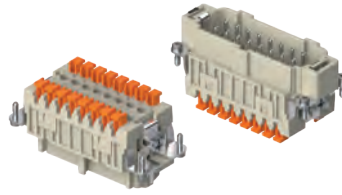
RE-OPENING

- Insert a **0,5 x 3,5 mm** flat blade screwdriver in the actuator button side window and pull it up by levering down.

CSHF/M 16 S 16 poles + ⊕ 16A - 500V SQUICH®

enclosures: size "77.27"	page:
C-TYPE IP65 or IP66/IP69	402 - 411
C7 IP67, two levers	439 - 440
V-TYPE IP65 or IP66/IP69, single lever	454 - 458
BIG hoods	470 - 471
T-TYPE IP65 insulating	484 - 485
T-TYPE / W IP66/IP69 insulating	491
HYGIENIC T-TYPE / H IP66/IP69	503
HYGIENIC T-TYPE / C IP66/IP69, -50 °C	508
W-TYPE for aggressive environments	523
E-Xtreme® corrosion proof	534 - 535, 544, 554 - 555
EMC	580
Central lever	609 - 611
LS-TYPE	622 - 623
IP68	640 - 643
panel supports:	page:
COB	652 - 653

inserts, spring terminal connections



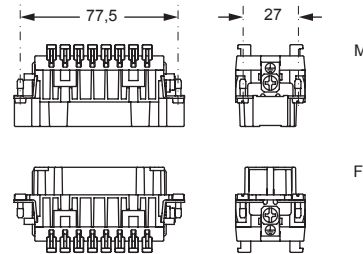
Q STAMPED CONTACTS, SILVER PLATED

description	part No.
-------------	----------

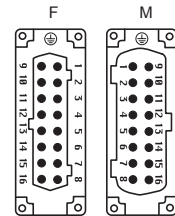
spring terminals with actuator button
female inserts with female contacts
male inserts with male contacts

CSHF 16 S
CSHM 16 S

- characteristics according to EN 61984:
16A 500V 6kV 3
16A 400/690V 6kV 2
- cULus (UL for USA and Canada) certified
CSA, CQC, DNV-GL, BV, EAC pending
- rated voltage according to UL/CSA: 600V
- insulation resistance: $\geq 10 \text{ G}\Omega$
- ambient temperature limit: $-40 \text{ }^\circ\text{C} \dots +125 \text{ }^\circ\text{C}$
- made of self-extinguishing thermoplastic resin
UL 94V-0
- mechanical life: ≥ 500 cycles
- contact resistance: $\leq 3 \text{ m}\Omega$
- for max. current load see the connector inserts derating
diagram below; for more information see page 28

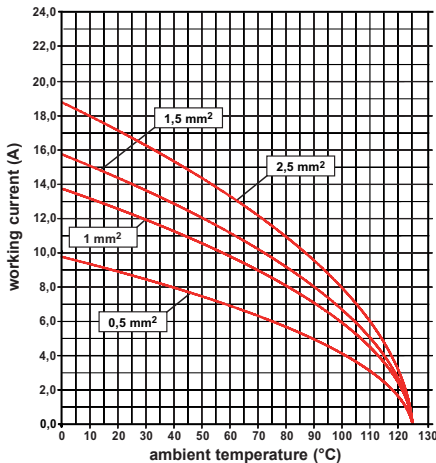


contacts side (front view)



- inserts for connectors with the following conductor
cross-sectional areas: 0,14 - 2,5 mm² - AWG 26 - 14
- conductors stripping length: 9...11 mm

CSH S 16 poles connector inserts
Maximum current load derating diagram



SQUICH®-spring connection technology

WIRING

- 1** Deeply insert a stripped conductor into a round terminal.
- 2** Push the actuator button to close the terminal.

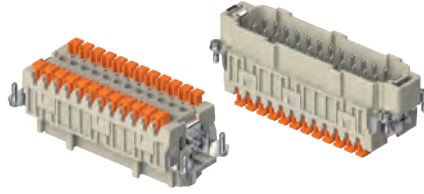
RE-OPENING

- 3** Insert a **0,5 x 3,5 mm** flat blade screwdriver in the actuator button side window and pull it up by levering down.

CSHF/M 24 S 24 poles + ⊕ 16A - 500V SQUICH®

enclosures: size "104.27"	page:
C-TYPE IP65 or IP66/IP69	412 - 423
C7 IP67, two levers	441 - 442
V-TYPE IP65 or IP66/IP69, single lever	459 - 463
BIG hoods	472 - 473
T-TYPE IP65 insulating	486 - 487
T-TYPE / W IP66/IP69 insulating	492
HYGIENIC T-TYPE / H IP66/IP69	504
HYGIENIC T-TYPE / C IP66/IP69, -50 °C	509
W-TYPE for aggressive environments	524
E-Xtreme® corrosion proof	536 - 537, 545, 556 - 557
EMC	581
Central lever	612 - 614
LS-TYPE	624 - 625
IP68	644 - 647
panel supports:	page:
COB	652 - 653

inserts, spring terminal connections



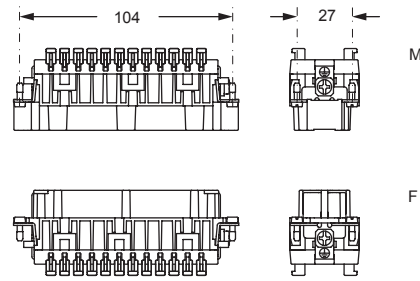
Q STAMPED CONTACTS, SILVER PLATED

description	part No.
-------------	----------

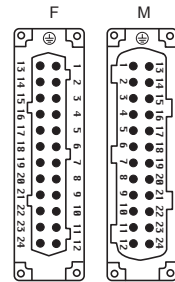
spring terminals with actuator button
female inserts with female contacts
male inserts with male contacts

CSHF 24 S
CSHM 24 S

- characteristics according to EN 61984:
16A 500V 6kV 3
16A 400/690V 6kV 2
- (UL for USA and Canada) certified
CSA, CQC, DNV-GL, BV, EAC pending
- rated voltage according to UL/CSA: 600V
- insulation resistance: $\geq 10 \text{ G}\Omega$
- ambient temperature limit: $-40 \text{ }^\circ\text{C} \dots +125 \text{ }^\circ\text{C}$
- made of self-extinguishing thermoplastic resin
UL 94V-0
- mechanical life: ≥ 500 cycles
- contact resistance: $\leq 3 \text{ m}\Omega$
- for max. current load see the connector inserts derating diagram below; for more information see page 28

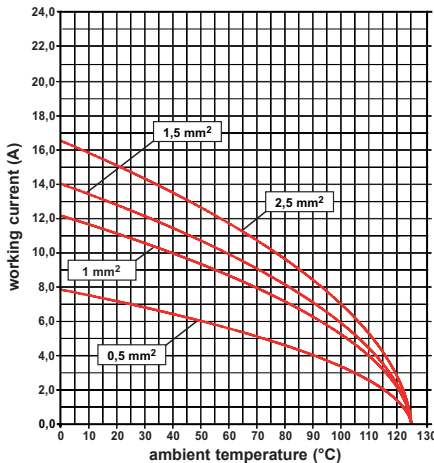


contacts side (front view)



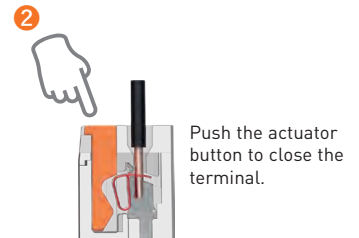
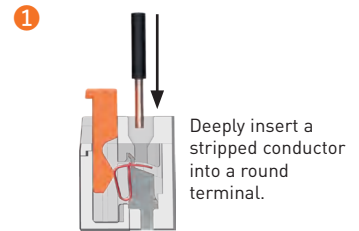
- inserts for connectors with the following conductor cross-sectional areas: $0,14 - 2,5 \text{ mm}^2$ - AWG 26 - 14
- conductors stripping length: 9...11 mm

CSH S 24 poles connector inserts
Maximum current load derating diagram

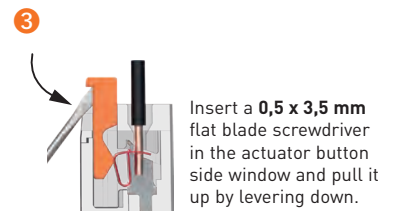


SQUICH®-spring connection technology

WIRING



RE-OPENING



CSHF/M SN 32 poles + ⊕ 16A - 500V SQUICH®

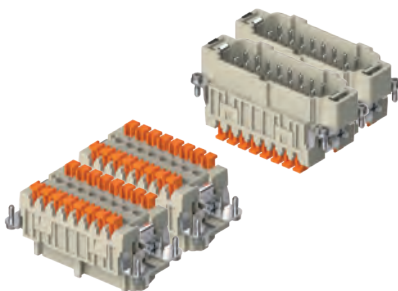
enclosures:
size "77.62"

page:

C-TYPE IP65 or IP66/IP69
W-TYPE for aggressive environments
E-Xtreme® corrosion proof

424 - 429
525
546

inserts,
spring terminal connections



Q STAMPED CONTACTS, SILVER PLATED

description

part No.

part No.

spring terminals with actuator button
female inserts with female contacts, No. (1-16) & (17-32)
male inserts with male contacts, No. (1-16) & (17-32)

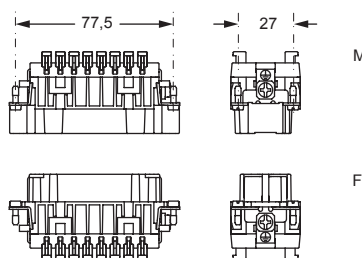
CSHF 16 S
CSHM 16 S

CSHF 16 SN
CSHM 16 SN

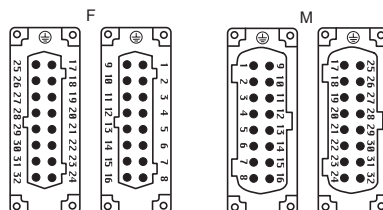
- characteristics according to EN 61984:

16A 500V 6kV 3
16A 400/690V 6kV 2

- cULus (UL for USA and Canada) certified
CSA, CQC, DNV-GL, BV, EAC pending
- rated voltage according to UL/CSA: 600V
- insulation resistance: $\geq 10 \text{ G}\Omega$
- ambient temperature limit: $-40 \text{ }^\circ\text{C} \dots +125 \text{ }^\circ\text{C}$
- made of self-extinguishing thermoplastic resin
UL 94V-0
- mechanical life: ≥ 500 cycles
- contact resistance: $\leq 3 \text{ m}\Omega$
- for max. current load see the connector inserts derating
diagram below; for more information see page 28

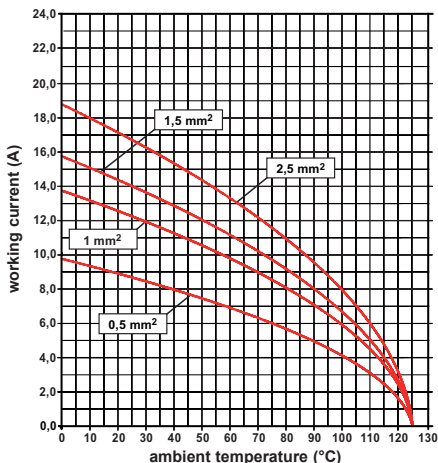


contacts side (front view)



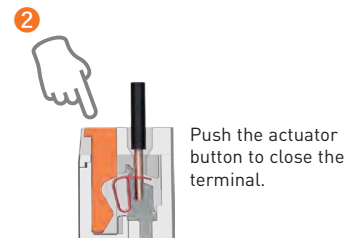
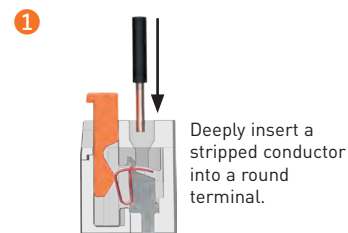
- inserts for connectors with the following conductor
cross-sectional areas: 0,14 - 2,5 mm² - AWG 26 - 14
- conductors stripping length: 9...11 mm

CSH S 32 poles connector inserts
Maximum current load derating diagram

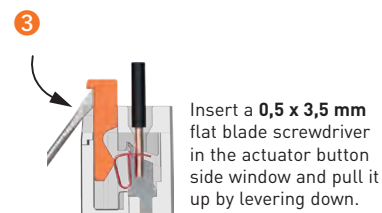


SQUICH®-spring connection technology

WIRING



RE-OPENING



CSHF/M SN 48 poles + ⊕ 16A - 500V SQUICH®

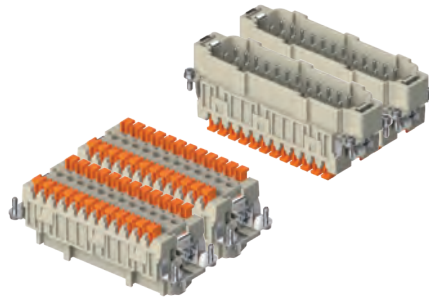
enclosures:
size "104.62"

page:

C-TYPE IP65 or IP66/IP69
W-TYPE for aggressive environments
E-Xtreme® corrosion proof

430
526
547

inserts,
spring terminal connections



Q STAMPED CONTACTS, SILVER PLATED

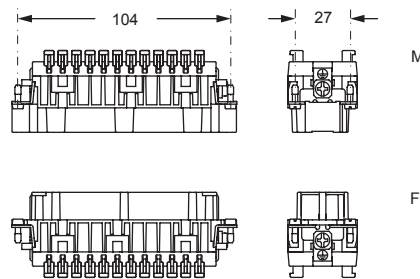
description	part No.	part No.
-------------	----------	----------

spring terminals with actuator button
female inserts with female contacts, No. (1-24) & (25-48)
male inserts with male contacts, No. (1-24) & (25-48)

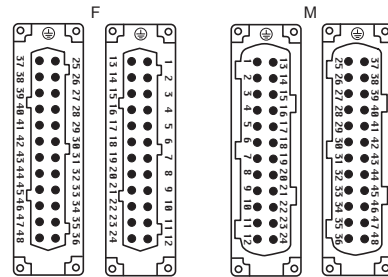
CSHF 24 S
CSHM 24 S

CSHF 24 SN
CSHM 24 SN

- characteristics according to EN 61984:
16A 500V 6kV 3
16A 400/690V 6kV 2
- cULus (UL for USA and Canada) certified
CSA, CQC, DNV-GL, BV, EAC pending
- rated voltage according to UL/CSA: 600V
- insulation resistance: $\geq 10 \text{ G}\Omega$
- ambient temperature limit: $-40 \text{ }^\circ\text{C} \dots +125 \text{ }^\circ\text{C}$
- made of self-extinguishing thermoplastic resin
UL 94V-0
- mechanical life: ≥ 500 cycles
- contact resistance: $\leq 3 \text{ m}\Omega$
- for max. current load see the connector inserts derating
diagram below; for more information see page 28

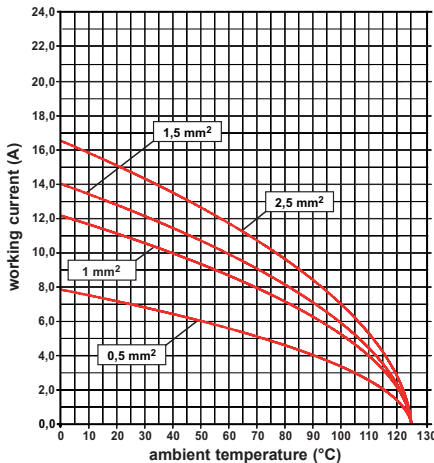


contacts side (front view)



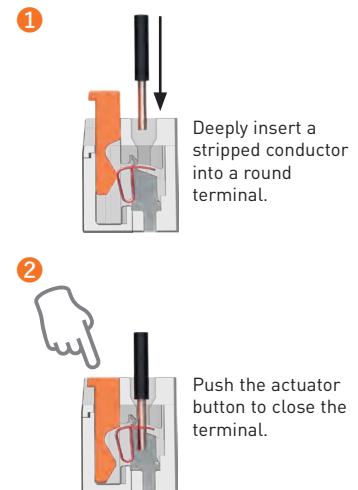
- inserts for connectors with the following conductor
cross-sectional areas: 0,14 - 2,5 mm² - AWG 26 - 14
- conductors stripping length: 9...11 mm

CSH S 48 poles connector inserts
Maximum current load derating diagram

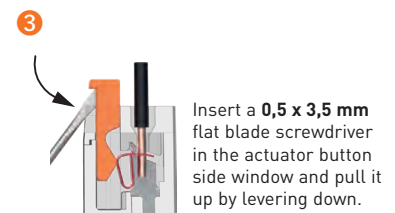


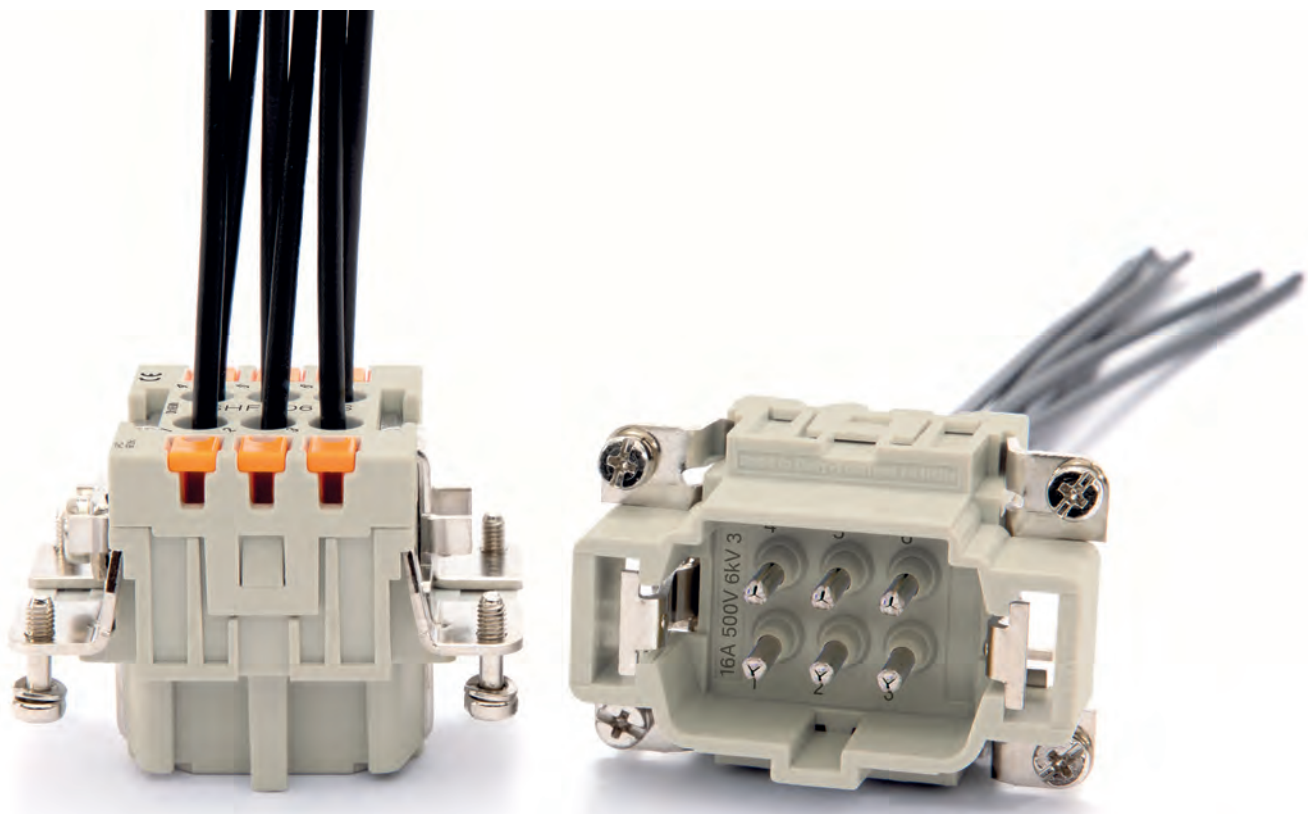
SQUICH®-spring connection technology

WIRING



RE-OPENING





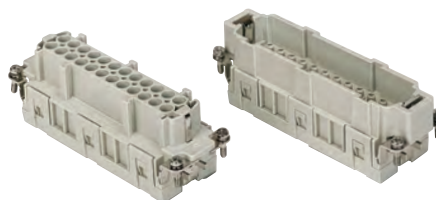
CCE series

TECHNICAL FEATURES

CCE series are the evolution of former CC series for removable crimp contacts CC series, with rated current up to 16A per pole.

It shares the four (six with double inserts) mating interfaces with series: **CNE** (screw-type), **CSH** (spring-type with actuator button, SQUICH® technology), **CSS** (double spring-type), CT (screw-type with 45° terminal block), **CTSE** (spring-type with 45° terminal block).

As for CNE series with former CN series, also CCE series are the result of a complete overhaul of the preceding CC series. Whereas CC series relied upon additional stainless steel spring element to perform contact retention, CCE series applies the modern and equally reliable concept of retention in the insulating body by a resilient element directly obtained in the contact holder. This enhances insulation, simplifies manufacturing and improves reliability.



CCE series, through increase of creepage distances, attains as well the **rated voltage increase to 500V from previous 400V value.**

Solid machined crimp contacts and the relevant connector inserts are the preferred option in fields of application subject to high vibration levels, such as railway rolling stock and everywhere transportation and moving parts are foreseen with e.g. motors as potential source of vibration.

Insert series		CCE
No. of poles ¹⁾	Main contacts + ⊕	6, 10, 16, 24, (32 = 2x16), (48 = 2x24)
	auxiliary contacts	—
Rated current ²⁾		16A
EN IEC 61984 Pollution degree 3	rated voltage	500V
	rated impulse voltage	6kV
	pollution degree	3
EN IEC 61984 Pollution degree 2	rated voltage	400/690V
	rated impulse voltage	6kV
	pollution degree	2
UL / CSA certification	rated voltage (a.c./d.c.)	600V
Contact resistance		≤ 1 mΩ
Insulation resistance		≥ 10 GΩ
Ambient temperature limit (°C)	min	-40 °C
	max	70 °C
Degree of protection	with enclosures	IP65, IP66/IP69, IP66/IP67/IP69, IP66/IP68/IP69 (according to type and model)
	without enclosures (in mated condition) - termination side on male and female inserts - mating side on female inserts	IP20 (IPXXB)
Conductor connections		crimp
Conductor cross-sectional area	mm ²	0,14 - 4
	AWG	26 - 12
Mechanical endurance (mating cycles)		≥ 500

1) Polarities shown in brackets may be obtained by using two inserts in their own double-sized housings

2) Please check the inserts derating diagrams to establish the actual maximum operating current according to the ambient temperature, the conductor cross-sectional area, the polarity of the connector, and any external constraint may derive e.g. by the continuous operating temperature sustained by the chosen conductor sheathing or by end-product safety standards fixing max allowed temperature rise on terminals (e.g. 30 K, 45 K or 50 K)

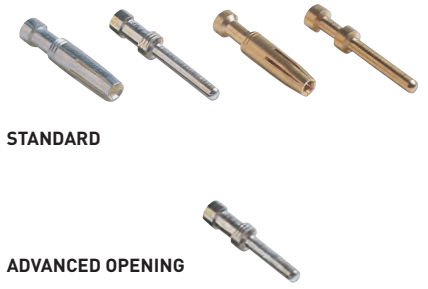
CCE 6 poles + ⊕ 16A - 500V

enclosures: size "44.27"	page:
C-TYPE IP65 or IP66/IP69	387 - 392
C7 IP67, single lever	436 - 437
V-TYPE IP65 or IP66/IP69, single lever	444 - 447
BIG hoods	466 - 467
T-TYPE IP65 insulating	480 - 481
T-TYPE / W IP66/IP69 insulating	489
HYGIENIC T-TYPE / H IP66/IP69	501
HYGIENIC T-TYPE / C IP66/IP69, -50 °C	506
W-TYPE for aggressive environments	521
E-Xtreme® corrosion proof	530 - 531, 542, 550 - 551
EMC	578
Central lever	603 - 605
LS-TYPE	618 - 619
IP68	632 - 635
panel supports: COB	page: 652 - 653

inserts, crimp connections

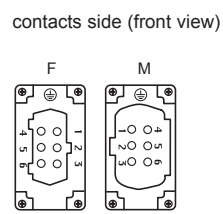
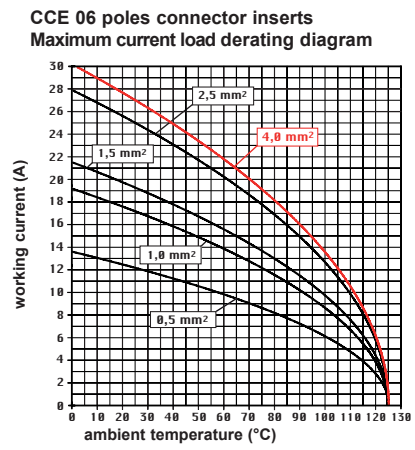
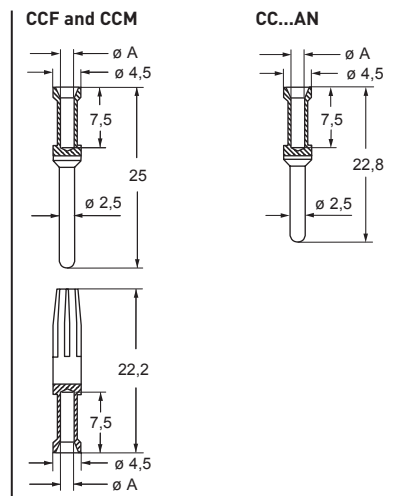
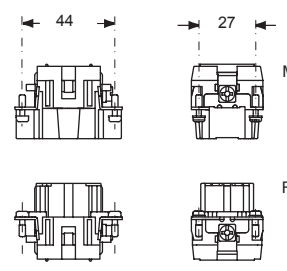


16A crimp contacts
standard or for advanced opening
silver and gold plated



description	part No.	part No.	part No.
without contacts (to be ordered separately)			
female inserts for female contacts	CCEF 06		
male inserts for male contacts	CCEM 06		
16A female contacts			
0,14-0,37 mm ² AWG 26-22 one groove		CCFA 0.3	CCFD 0.3
0,5 mm ² AWG 20 with no grooves		CCFA 0.5	CCFD 0.5
0,75 mm ² AWG 18 one groove (back side)		CCFA 0.7	CCFD 0.7
1 mm ² AWG 18 one groove		CCFA 1.0	CCFD 1.0
1,5 mm ² AWG 16 two grooves		CCFA 1.5	CCFD 1.5
2,5 mm ² AWG 14 three grooves		CCFA 2.5	CCFD 2.5
3 mm ² AWG 12 one wide groove		CCFA 3.0	CCFD 3.0
4 mm ² AWG 12 with no grooves		CCFA 4.0	CCFD 4.0
16A male contacts			
0,14-0,37 mm ² AWG 26-22 one groove		CCMA 0.3	CCMD 0.3
0,5 mm ² AWG 20 with no grooves		CCMA 0.5	CCMD 0.5
0,75 mm ² AWG 18 one groove (back side)		CCMA 0.7	CCMD 0.7
1 mm ² AWG 18 one groove		CCMA 1.0	CCMD 1.0
1,5 mm ² AWG 16 two grooves		CCMA 1.5	CCMD 1.5
2,5 mm ² AWG 14 three grooves		CCMA 2.5	CCMD 2.5
3 mm ² AWG 12 one wide groove		CCMA 3.0	CCMD 3.0
4 mm ² AWG 12 with no grooves		CCMA 4.0	CCMD 4.0
16A male crimp contacts for advanced opening			
0,5 mm ² AWG 20 with no grooves		CC 0.5 AN	* for basic or high thickness gold plating, please refer to page 675
0,75 mm ² AWG 18 one groove (back side)		CC 0.7 AN	
1 mm ² AWG 18 one groove		CC 1.0 AN	
1,5 mm ² AWG 16 two grooves		CC 1.5 AN	
2,5 mm ² AWG 14 three grooves		CC 2.5 AN	

- characteristics according to EN 61984:
16A 500V 6kV 3
16A 400/690V 6kV 2
- certified
- rated voltage according to UL/CSA: 600V
- insulation resistance: ≥ 10 GΩ
- ambient temperature limit: -40 °C ... +125 °C
- made of self-extinguishing thermoplastic resin UL 94V-0
- mechanical life: ≥ 500 cycles
- contact resistance: ≤ 1 mΩ
- for max. current load see the connector inserts derating diagram below; for more information see page 28



- it is recommended to crimp the contacts with crimping tools homologated by ILME (please see the crimping tool section 16A contacts, CCF, CCM and CC...AN series on pages 708 - 741)

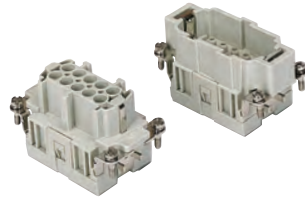
CCF, CCM and CC...AN contacts

conductor section mm ²	conductor slot ø A (mm)	conductors stripping length (mm)
0,14-0,37	0,9	7,5
0,5	1,1	7,5
0,75	1,3	7,5
1,0	1,45	7,5
1,5	1,8	7,5
2,5	2,2	7,5
3	2,55	7,5
4	2,85	7,5

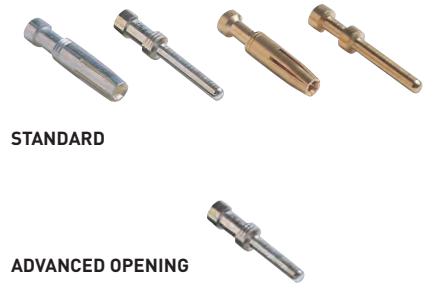
CCE 10 poles + ⊕ 16A - 500V

enclosures: size "57.27"	page:
C-TYPE IP65 or IP66/IP69	393 - 401
C7 IP67, two levers	438
V-TYPE IP65 or IP66/IP69, single lever	448 - 453
BIG hoods	468 - 469
T-TYPE IP65 insulating	482 - 483
T-TYPE / W IP66/IP69 insulating	490
HYGIENIC T-TYPE / H IP66/IP69	502
HYGIENIC T-TYPE / C IP66/IP69, -50 °C	507
W-TYPE for aggressive environments	522
E-Xtreme® corrosion proof	532 - 533, 543, 552 - 553
EMC	579
Central lever	606 - 608
LS-TYPE	620 - 621
IP68	636 - 639
panel supports:	page:
COB	652 - 653

inserts, crimp connections



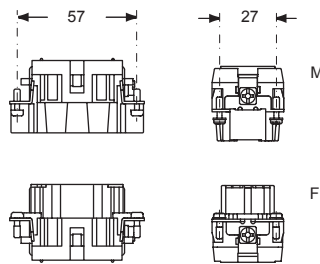
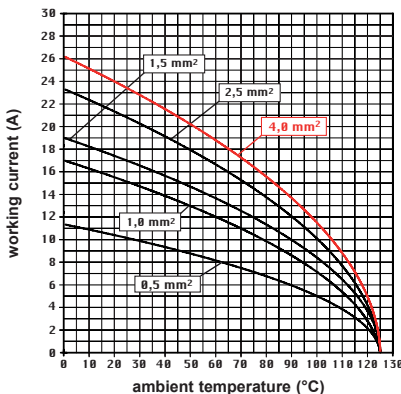
16A crimp contacts
standard or for advanced opening
silver and gold plated



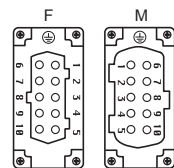
description	part No.	part No.	part No.
without contacts (to be ordered separately)			
female inserts for female contacts	CCEF 10		
male inserts for male contacts	CCEM 10		
16A female contacts			
0,14-0,37 mm ² AWG 26-22 one groove		CCFA 0.3	CCFD 0.3
0,5 mm ² AWG 20 with no grooves		CCFA 0.5	CCFD 0.5
0,75 mm ² AWG 18 one groove (back side)		CCFA 0.7	CCFD 0.7
1 mm ² AWG 18 one groove		CCFA 1.0	CCFD 1.0
1,5 mm ² AWG 16 two grooves		CCFA 1.5	CCFD 1.5
2,5 mm ² AWG 14 three grooves		CCFA 2.5	CCFD 2.5
3 mm ² AWG 12 one wide groove		CCFA 3.0	CCFD 3.0
4 mm ² AWG 12 with no grooves		CCFA 4.0	CCFD 4.0
16A male contacts			
0,14-0,37 mm ² AWG 26-22 one groove		CCMA 0.3	CCMD 0.3
0,5 mm ² AWG 20 with no grooves		CCMA 0.5	CCMD 0.5
0,75 mm ² AWG 18 one groove (back side)		CCMA 0.7	CCMD 0.7
1 mm ² AWG 18 one groove		CCMA 1.0	CCMD 1.0
1,5 mm ² AWG 16 two grooves		CCMA 1.5	CCMD 1.5
2,5 mm ² AWG 14 three grooves		CCMA 2.5	CCMD 2.5
3 mm ² AWG 12 one wide groove		CCMA 3.0	CCMD 3.0
4 mm ² AWG 12 with no grooves		CCMA 4.0	CCMD 4.0
16A male crimp contacts for advanced opening			
0,5 mm ² AWG 20 with no grooves		CC 0.5 AN	* for basic or high thickness gold plating, please refer to page 675
0,75 mm ² AWG 18 one groove (back side)		CC 0.7 AN	
1 mm ² AWG 18 one groove		CC 1.0 AN	
1,5 mm ² AWG 16 two grooves		CC 1.5 AN	
2,5 mm ² AWG 14 three grooves		CC 2.5 AN	

- characteristics according to EN 61984:
16A 500V 6kV 3
16A 400/690V 6kV 2
- certified
- rated voltage according to UL/CSA: 600V
- insulation resistance: ≥ 10 GΩ
- ambient temperature limit: -40 °C ... +125 °C
- made of self-extinguishing thermoplastic resin UL 94V-0
- mechanical life: ≥ 500 cycles
- contact resistance: ≤ 1 mΩ
- for max. current load see the connector inserts derating diagram below; for more information see page 28

CCE 10 poles connector inserts
Maximum current load derating diagram

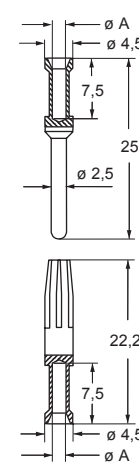


contacts side (front view)

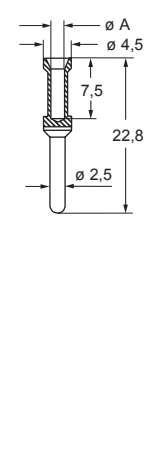


- it is recommended to crimp the contacts with crimping tools homologated by ILME (please see the crimping tool section 16A contacts, CCF, CCM and CC...AN series on pages 708 - 741)

CCF and CCM



CC...AN



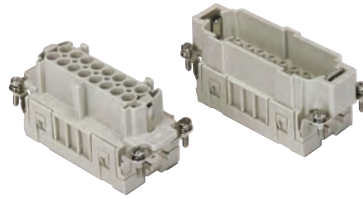
CCF, CCM and CC...AN contacts

conductor section mm ²	conductor slot ø A (mm)	conductors stripping length (mm)
0,14-0,37	0,9	7,5
0,5	1,1	7,5
0,75	1,3	7,5
1,0	1,45	7,5
1,5	1,8	7,5
2,5	2,2	7,5
3	2,55	7,5
4	2,85	7,5

CCE 16 poles + ⊕ 16A - 500V

enclosures: size "77.27"	page:
C-TYPE IP65 or IP66/IP69	402 - 411
C7 IP67, two levers	439 - 440
V-TYPE IP65 or IP66/IP69, single lever	454 - 458
BIG hoods	470 - 471
T-TYPE IP65 insulating	484 - 485
T-TYPE / W IP66/IP69 insulating	491
HYGIENIC T-TYPE / H IP66/IP69	503
HYGIENIC T-TYPE / C IP66/IP69, -50 °C	508
W-TYPE for aggressive environments	523
E-Xtreme® corrosion proof	534 - 535, 544, 554 - 555
EMC	580
Central lever	609 - 611
LS-TYPE	622 - 623
IP68	640 - 643
panel supports:	page:
COB	652 - 653

inserts, crimp connections



16A crimp contacts
standard or for advanced opening
silver and gold plated

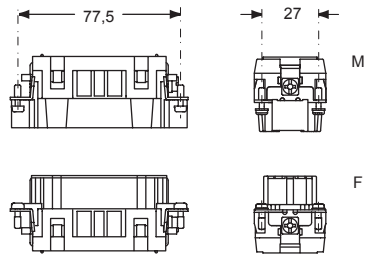


STANDARD

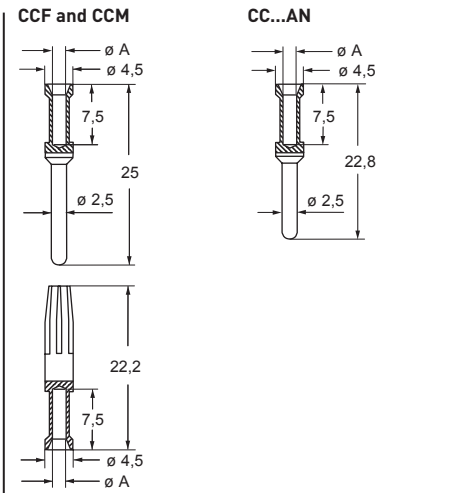
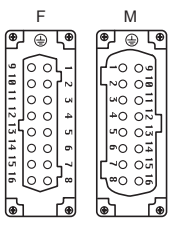
ADVANCED OPENING

description	part No.	part No.	part No.
without contacts (to be ordered separately)			
female inserts for female contacts	CCEF 16		
male inserts for male contacts	CCEM 16		
16A female contacts			
0,14-0,37 mm ² AWG 26-22 one groove		CCFA 0.3	CCFD 0.3
0,5 mm ² AWG 20 with no grooves		CCFA 0.5	CCFD 0.5
0,75 mm ² AWG 18 one groove (back side)		CCFA 0.7	CCFD 0.7
1 mm ² AWG 18 one groove		CCFA 1.0	CCFD 1.0
1,5 mm ² AWG 16 two grooves		CCFA 1.5	CCFD 1.5
2,5 mm ² AWG 14 three grooves		CCFA 2.5	CCFD 2.5
3 mm ² AWG 12 one wide groove		CCFA 3.0	CCFD 3.0
4 mm ² AWG 12 with no grooves		CCFA 4.0	CCFD 4.0
16A male contacts			
0,14-0,37 mm ² AWG 26-22 one groove		CCMA 0.3	CCMD 0.3
0,5 mm ² AWG 20 with no grooves		CCMA 0.5	CCMD 0.5
0,75 mm ² AWG 18 one groove (back side)		CCMA 0.7	CCMD 0.7
1 mm ² AWG 18 one groove		CCMA 1.0	CCMD 1.0
1,5 mm ² AWG 16 two grooves		CCMA 1.5	CCMD 1.5
2,5 mm ² AWG 14 three grooves		CCMA 2.5	CCMD 2.5
3 mm ² AWG 12 one wide groove		CCMA 3.0	CCMD 3.0
4 mm ² AWG 12 with no grooves		CCMA 4.0	CCMD 4.0
16A male crimp contacts for advanced opening			
0,5 mm ² AWG 20 with no grooves		CC 0.5 AN	* for basic or high thickness gold plating, please refer to page 675
0,75 mm ² AWG 18 one groove (back side)		CC 0.7 AN	
1 mm ² AWG 18 one groove		CC 1.0 AN	
1,5 mm ² AWG 16 two grooves		CC 1.5 AN	
2,5 mm ² AWG 14 three grooves		CC 2.5 AN	

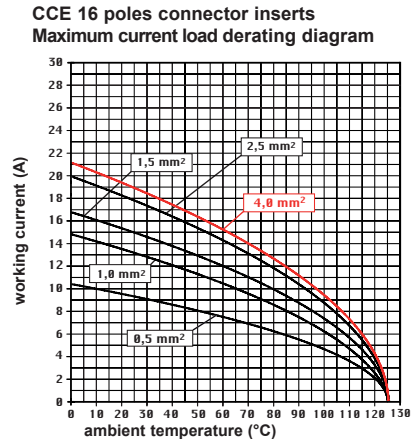
- characteristics according to EN 61984:
16A 500V 6kV 3
16A 400/690V 6kV 2
- certified
- rated voltage according to UL/CSA: 600V
- insulation resistance: ≥ 10 GΩ
- ambient temperature limit: -40 °C ... +125 °C
- made of self-extinguishing thermoplastic resin UL 94V-0
- mechanical life: ≥ 500 cycles
- contact resistance: ≤ 1 mΩ
- for max. current load see the connector inserts derating diagram below; for more information see page 28



contacts side (front view)



CCF, CCM and CC...AN contacts		
conductor section mm ²	conductor slot ø A (mm)	conductors stripping length (mm)
0,14-0,37	0,9	7,5
0,5	1,1	7,5
0,75	1,3	7,5
1,0	1,45	7,5
1,5	1,8	7,5
2,5	2,2	7,5
3	2,55	7,5
4	2,85	7,5

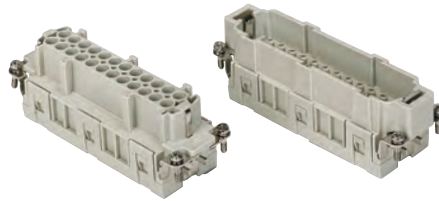


- it is recommended to crimp the contacts with crimping tools homologated by ILME (please see the crimping tool section 16A contacts, CCF, CCM and CC...AN series on pages 708 - 741)

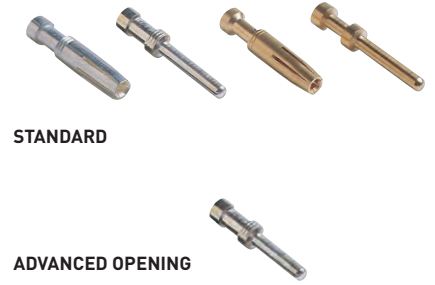
CCE 24 poles + ⊕ 16A - 500V

enclosures: size "104.27"	page:
C-TYPE IP65 or IP66/IP69	412 - 423
C7 IP67, two levers	441 - 442
V-TYPE IP65 or IP66/IP69, single lever	459 - 463
BIG hoods	472 - 473
T-TYPE IP65 insulating	486 - 487
T-TYPE / W IP66/IP69 insulating	492
HYGIENIC T-TYPE / H IP66/IP69	504
HYGIENIC T-TYPE / C IP66/IP69, -50 °C	509
W-TYPE for aggressive environments	524
E-Xtreme® corrosion proof	536 - 537, 545, 556 - 557
EMC	581
Central lever	612 - 614
LS-TYPE	624 - 625
IP68	644 - 647
panel supports:	page:
COB	652 - 653

inserts, crimp connections

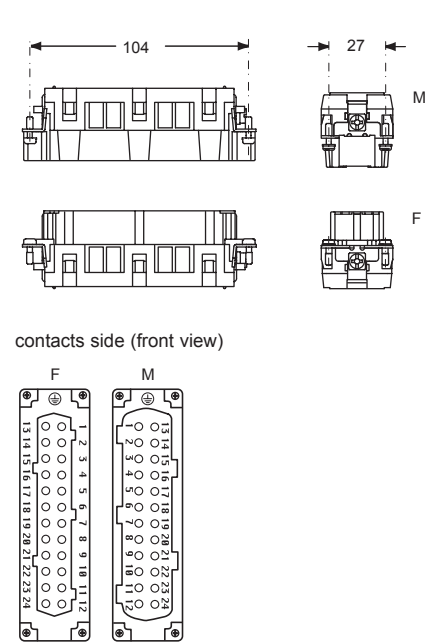
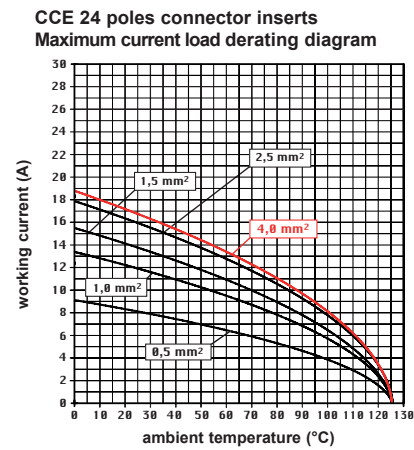


16A crimp contacts
standard or for advanced opening
silver and gold plated



description	part No.	part No.	part No.
without contacts (to be ordered separately)			
female inserts for female contacts	CCEF 24		
male inserts for male contacts	CCEM 24		
16A female contacts			
0,14-0,37 mm ² AWG 26-22 one groove		CCFA 0.3	CCFD 0.3
0,5 mm ² AWG 20 with no grooves		CCFA 0.5	CCFD 0.5
0,75 mm ² AWG 18 one groove (back side)		CCFA 0.7	CCFD 0.7
1 mm ² AWG 18 one groove		CCFA 1.0	CCFD 1.0
1,5 mm ² AWG 16 two grooves		CCFA 1.5	CCFD 1.5
2,5 mm ² AWG 14 three grooves		CCFA 2.5	CCFD 2.5
3 mm ² AWG 12 one wide groove		CCFA 3.0	CCFD 3.0
4 mm ² AWG 12 with no grooves		CCFA 4.0	CCFD 4.0
16A male contacts			
0,14-0,37 mm ² AWG 26-22 one groove		CCMA 0.3	CCMD 0.3
0,5 mm ² AWG 20 with no grooves		CCMA 0.5	CCMD 0.5
0,75 mm ² AWG 18 one groove (back side)		CCMA 0.7	CCMD 0.7
1 mm ² AWG 18 one groove		CCMA 1.0	CCMD 1.0
1,5 mm ² AWG 16 two grooves		CCMA 1.5	CCMD 1.5
2,5 mm ² AWG 14 three grooves		CCMA 2.5	CCMD 2.5
3 mm ² AWG 12 one wide groove		CCMA 3.0	CCMD 3.0
4 mm ² AWG 12 with no grooves		CCMA 4.0	CCMD 4.0
16A male crimp contacts for advanced opening			
0,5 mm ² AWG 20 with no grooves		CC 0.5 AN	* for basic or high thickness gold plating, please refer to page 675
0,75 mm ² AWG 18 one groove (back side)		CC 0.7 AN	
1 mm ² AWG 18 one groove		CC 1.0 AN	
1,5 mm ² AWG 16 two grooves		CC 1.5 AN	
2,5 mm ² AWG 14 three grooves		CC 2.5 AN	

- characteristics according to EN 61984:
16A 500V 6kV 3
16A 400/690V 6kV 2
- certified
- rated voltage according to UL/CSA: 600V
- insulation resistance: ≥ 10 GΩ
- ambient temperature limit: -40 °C ... +125 °C
- made of self-extinguishing thermoplastic resin UL 94V-0
- mechanical life: ≥ 500 cycles
- contact resistance: ≤ 1 mΩ
- for max. current load see the connector inserts derating diagram below; for more information see page 28



- it is recommended to crimp the contacts with crimping tools homologated by ILME (please see the crimping tool section 16A contacts, CCF, CCM and CC...AN series on pages 708 - 741)

CCF and CCM		CC...AN
CCF, CCM and CC...AN contacts		
conductor section mm ²	conductor slot ø A (mm)	conductors stripping length (mm)
0,14-0,37	0,9	7,5
0,5	1,1	7,5
0,75	1,3	7,5
1,0	1,45	7,5
1,5	1,8	7,5
2,5	2,2	7,5
3	2,55	7,5
4	2,85	7,5

CCE

CCE 32 poles + ⊕ 16A - 500V

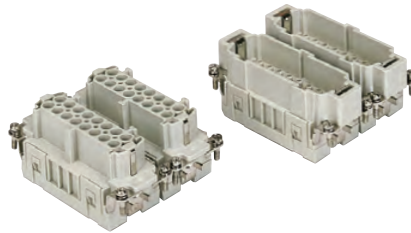
enclosures:
size "77.62"

page:

C-TYPE IP65 or IP66/IP69
W-TYPE for aggressive environments
E-Xtreme® corrosion proof

424 - 429
525
546

inserts, crimp connections



16A crimp contacts standard or for advanced opening silver and gold plated



STANDARD

ADVANCED OPENING

description	part No.	part No.	part No.	part No.
without contacts (to be ordered separately)				
female inserts for female contacts, No. (1-16) and (17-32)	CCEF 16	CCEF 16 N		
male inserts for male contacts, No. (1-16) and (17-32)	CCEM 16	CCEM 16 N		
16A female contacts				
0,14-0,37 mm ² AWG 26-22 one groove			CCFA 0.3	CCFD 0.3
0,5 mm ² AWG 20 with no grooves			CCFA 0.5	CCFD 0.5
0,75 mm ² AWG 18 one groove (back side)			CCFA 0.7	CCFD 0.7
1 mm ² AWG 18 one groove			CCFA 1.0	CCFD 1.0
1,5 mm ² AWG 16 two grooves			CCFA 1.5	CCFD 1.5
2,5 mm ² AWG 14 three grooves			CCFA 2.5	CCFD 2.5
3 mm ² AWG 12 one wide groove			CCFA 3.0	CCFD 3.0
4 mm ² AWG 12 with no grooves			CCFA 4.0	CCFD 4.0
16A male contacts				
0,14-0,37 mm ² AWG 26-22 one groove			CCMA 0.3	CCMD 0.3
0,5 mm ² AWG 20 with no grooves			CCMA 0.5	CCMD 0.5
0,75 mm ² AWG 18 one groove (back side)			CCMA 0.7	CCMD 0.7
1 mm ² AWG 18 one groove			CCMA 1.0	CCMD 1.0
1,5 mm ² AWG 16 two grooves			CCMA 1.5	CCMD 1.5
2,5 mm ² AWG 14 three grooves			CCMA 2.5	CCMD 2.5
3 mm ² AWG 12 one wide groove			CCMA 3.0	CCMD 3.0
4 mm ² AWG 12 with no grooves			CCMA 4.0	CCMD 4.0
16A male crimp contacts for advanced opening				
0,5 mm ² AWG 20 with no grooves			CC 0.5 AN	* for basic or high thickness gold plating, please refer to page 675
0,75 mm ² AWG 18 one groove (back side)			CC 0.7 AN	
1 mm ² AWG 18 one groove			CC 1.0 AN	
1,5 mm ² AWG 16 two grooves			CC 1.5 AN	
2,5 mm ² AWG 14 three grooves			CC 2.5 AN	

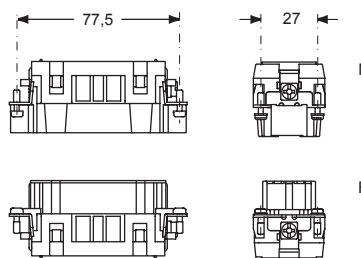
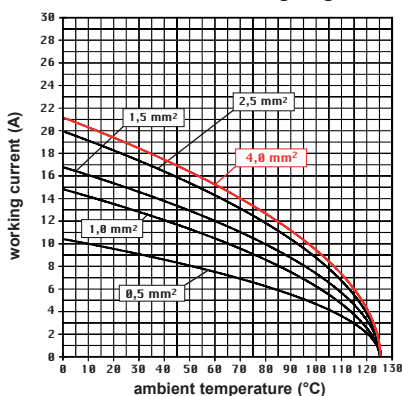
- characteristics according to EN 61984:

16A 500V 6kV 3
16A 400/690V 6kV 2

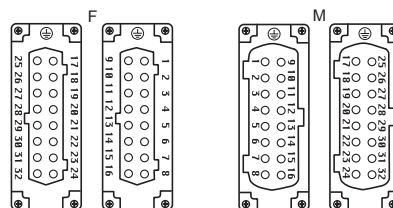
- certified

- rated voltage according to UL/CSA: 600V
- insulation resistance: ≥ 10 GΩ
- ambient temperature limit: -40 °C ... +125 °C
- made of self-extinguishing thermoplastic resin UL 94V-0
- mechanical life: ≥ 500 cycles
- contact resistance: ≤ 1 mΩ
- for max. current load see the connector inserts derating diagram below; for more information see page 28

CCE 32 poles connector inserts
Maximum current load derating diagram

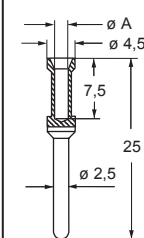


contacts side (front view)

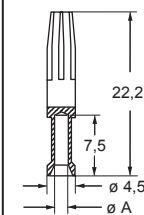
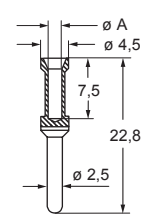


- it is recommended to crimp the contacts with crimping tools homologated by ILME (please see the crimping tool section 16A contacts, CCF, CCM and CC...AN series on pages 708 - 741)

CCF and CCM



CC...AN



CCF, CCM and CC...AN contacts

conductor section mm ²	conductor slot ø A (mm)	conductors stripping length (mm)
0,14-0,37	0,9	7,5
0,5	1,1	7,5
0,75	1,3	7,5
1,0	1,45	7,5
1,5	1,8	7,5
2,5	2,2	7,5
3	2,55	7,5
4	2,85	7,5

CCE 48 poles + ⊕ 16A - 500V

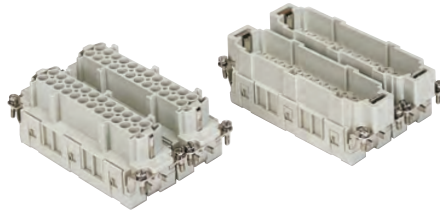
enclosures:
size "104.62"

page:

C-TYPE IP65 or IP66/IP69
W-TYPE for aggressive environments
E-Xtreme® corrosion proof

430
526
547

inserts, crimp connections



16A crimp contacts standard or for advanced opening silver and gold plated



STANDARD



ADVANCED OPENING

description	part No.	part No.	part No.	part No.
without contacts (to be ordered separately)				
female inserts for female contacts, No. (1-24) and (25-48)	CCEF 24	CCEF 24 N		
male inserts for male contacts, No. (1-24) and (25-48)	CCEM 24	CCEM 24 N		
16A female contacts				
0,14-0,37 mm ² AWG 26-22 one groove			CCFA 0.3	CCFD 0.3
0,5 mm ² AWG 20 with no grooves			CCFA 0.5	CCFD 0.5
0,75 mm ² AWG 18 one groove (back side)			CCFA 0.7	CCFD 0.7
1 mm ² AWG 18 one groove			CCFA 1.0	CCFD 1.0
1,5 mm ² AWG 16 two grooves			CCFA 1.5	CCFD 1.5
2,5 mm ² AWG 14 three grooves			CCFA 2.5	CCFD 2.5
3 mm ² AWG 12 one wide groove			CCFA 3.0	CCFD 3.0
4 mm ² AWG 12 with no grooves			CCFA 4.0	CCFD 4.0
16A male contacts				
0,14-0,37 mm ² AWG 26-22 one groove			CCMA 0.3	CCMD 0.3
0,5 mm ² AWG 20 with no grooves			CCMA 0.5	CCMD 0.5
0,75 mm ² AWG 18 one groove (back side)			CCMA 0.7	CCMD 0.7
1 mm ² AWG 18 one groove			CCMA 1.0	CCMD 1.0
1,5 mm ² AWG 16 two grooves			CCMA 1.5	CCMD 1.5
2,5 mm ² AWG 14 three grooves			CCMA 2.5	CCMD 2.5
3 mm ² AWG 12 one wide groove			CCMA 3.0	CCMD 3.0
4 mm ² AWG 12 with no grooves			CCMA 4.0	CCMD 4.0
16A male crimp contacts for advanced opening				
0,5 mm ² AWG 20 with no grooves			CC 0.5 AN	* for basic or high thickness gold plating, please refer to page 675
0,75 mm ² AWG 18 one groove (back side)			CC 0.7 AN	
1 mm ² AWG 18 one groove			CC 1.0 AN	
1,5 mm ² AWG 16 two grooves			CC 1.5 AN	
2,5 mm ² AWG 14 three grooves			CC 2.5 AN	

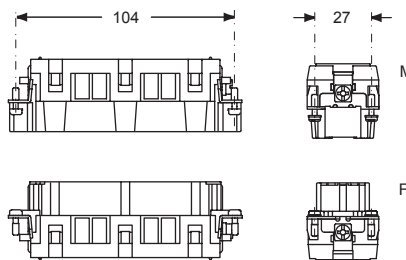
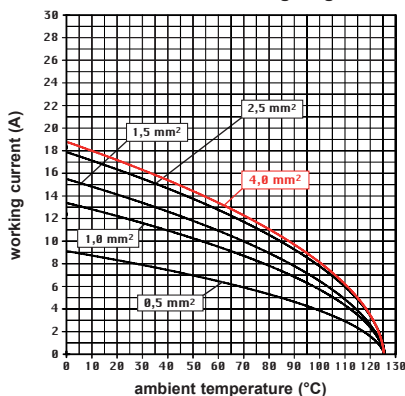
- characteristics according to EN 61984:

16A 500V 6kV 3
16A 400/690V 6kV 2

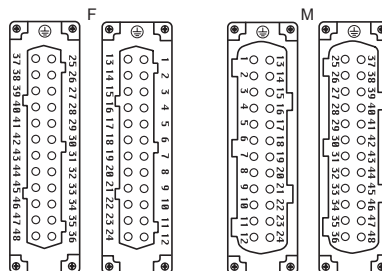
- certified

- rated voltage according to UL/CSA: 600V
- insulation resistance: ≥ 10 GΩ
- ambient temperature limit: -40 °C ... +125 °C
- made of self-extinguishing thermoplastic resin UL 94V-0
- mechanical life: ≥ 500 cycles
- contact resistance: ≤ 1 mΩ
- for max. current load see the connector inserts derating diagram below; for more information see page 28

CCE 48 poles connector inserts
Maximum current load derating diagram

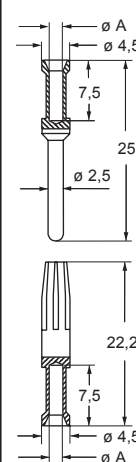


contacts side (front view)

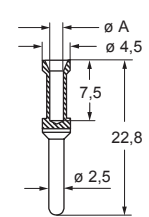


- it is recommended to crimp the contacts with crimping tools homologated by ILME (please see the crimping tool section 16A contacts, CCF, CCM and CC...AN series on pages 708 - 741)

CCF and CCM



CC...AN



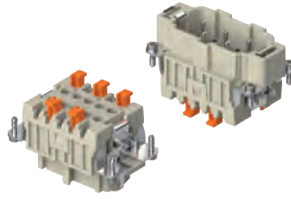
CCF, CCM and CC...AN contacts

conductor section mm ²	conductor slot ø A (mm)	conductors stripping length (mm)
0,14-0,37	0,9	7,5
0,5	1,1	7,5
0,75	1,3	7,5
1,0	1,45	7,5
1,5	1,8	7,5
2,5	2,2	7,5
3	2,55	7,5
4	2,85	7,5

CM SH-SQUICH® 3 + 2 (aux) poles + ⊕ 16A - 830V

enclosures: size "57.27"	page:
C-TYPE IP65 or IP66/IP69	393 - 401
C7 IP67, two levers	438
V-TYPE IP65 or IP66/IP69, single lever	448 - 453
BIG hoods	468 - 469
T-TYPE IP65 insulating	482 - 483
T-TYPE / W IP66/IP69 insulating	490
HYGIENIC T-TYPE / H IP66/IP69	502
HYGIENIC T-TYPE / C IP66/IP69, -50 °C	507
W-TYPE for aggressive environments	522
E-Xtreme® corrosion proof	532 - 533, 543, 552 - 553
EMC	579
Central lever	606 - 608
LS-TYPE	620 - 621
IP68	636 - 639
panel supports:	page:
COB	652 - 653

inserts,
spring terminal connection without tools



Q SILVER PLATED CONTACTS

description	part No.
-------------	----------

spring terminals with actuator button
female inserts with female contacts
male inserts with male contacts

CMSHF 03
CMSHM 03

- characteristics according to EN 61984:

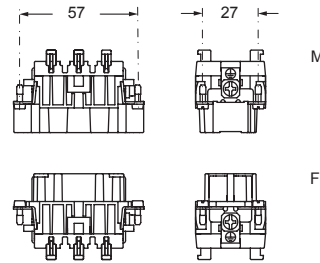
- 16A 830V 8kV 3**
- 16A 1000V 8kV 2**
- 16A 720/1250V 8kV 2**

- auxiliary contacts: **16A 500V 6kV 3**

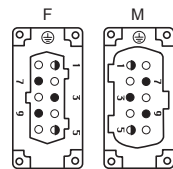
- us (UL for USA and Canada),

ERC certified

- rated voltage according to UL/CSA: 600V
- insulation resistance: $\geq 10 \text{ G}\Omega$
- ambient temperature limit: -40 °C ... +125 °C
- made of self-extinguishing thermoplastic resin UL 94V-0
- mechanical life: ≥ 500 cycles
- contact resistance: $\leq 3 \text{ m}\Omega$
- for max. current load see the connector inserts derating diagram below; for more information see page 28



contacts side (front view)

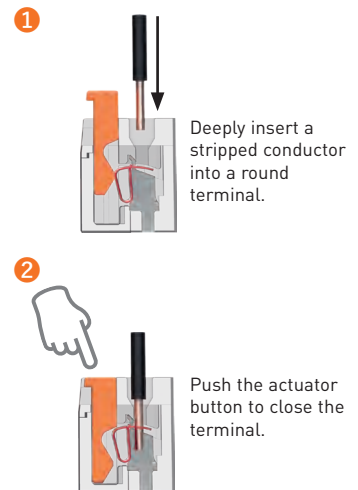


● the auxiliary contacts are in the forward position upon opening

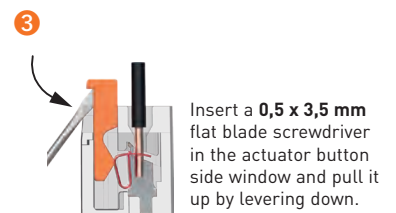
- inserts for section conductors: 0,14 - 2,5 mm² - AWG 26 - 14
- conductors stripping length: 9...11 mm

SQUICH®-spring connection technology

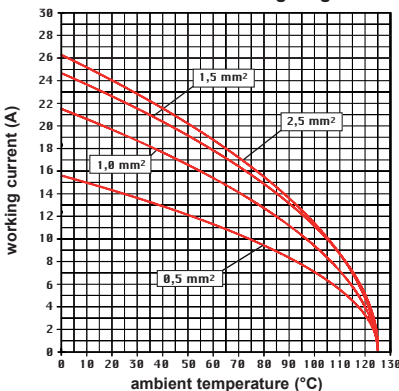
WIRING



RE-OPENING



CM SH 03 poles connector inserts
Maximum current load derating diagram

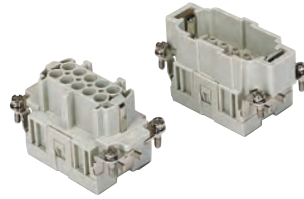


CM SH-SQUICH® 830V

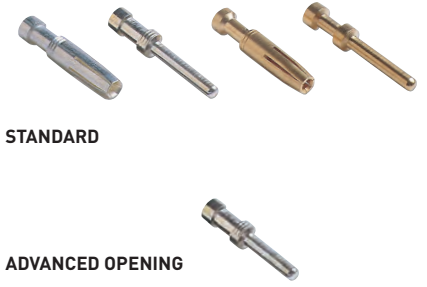
CMCE 3 + 2 (aux) poles + ⊕ 16A - 830V

enclosures: size "57.27"	page:
C-TYPE IP65 or IP66/IP69	393 - 401
C7 IP67, two levers	438
V-TYPE IP65 or IP66/IP69, single lever	448 - 453
BIG hoods	468 - 469
T-TYPE IP65 insulating	482 - 483
T-TYPE / W IP66/IP69 insulating	490
HYGIENIC T-TYPE / H IP66/IP69	502
HYGIENIC T-TYPE / C IP66/IP69, -50 °C	507
W-TYPE for aggressive environments	522
E-Xtreme® corrosion proof	532 - 533, 543, 552 - 553
EMC	579
Central lever	606 - 608
LS-TYPE	620 - 621
IP68	636 - 639
panel supports: COB	page: 652 - 653

inserts, crimp connections



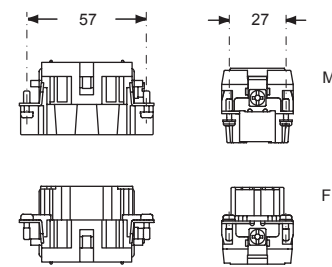
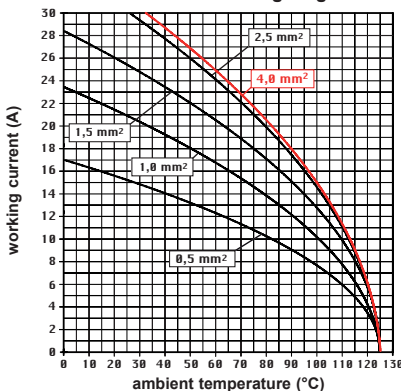
16A crimp contacts standard or for advanced opening silver and gold plated



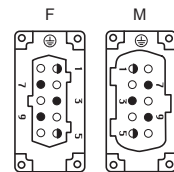
description	part No.	part No.	part No.
without contacts (to be ordered separately)			
female inserts for female contacts	CMCE03		
male inserts for male contacts	CMCEM 03		
16A female contacts			
0,14-0,37 mm ² AWG 26-22 one groove		CCFA 0.3	CCFD 0.3
0,5 mm ² AWG 20 with no grooves		CCFA 0.5	CCFD 0.5
0,75 mm ² AWG 18 one groove (back side)		CCFA 0.7	CCFD 0.7
1 mm ² AWG 18 one groove		CCFA 1.0	CCFD 1.0
1,5 mm ² AWG 16 two grooves		CCFA 1.5	CCFD 1.5
2,5 mm ² AWG 14 three grooves		CCFA 2.5	CCFD 2.5
3 mm ² AWG 12 one wide groove		CCFA 3.0	CCFD 3.0
4 mm ² AWG 12 with no grooves		CCFA 4.0	CCFD 4.0
16A male contacts			
0,14-0,37 mm ² AWG 26-22 one groove		CCMA 0.3	CCMD 0.3
0,5 mm ² AWG 20 with no grooves		CCMA 0.5	CCMD 0.5
0,75 mm ² AWG 18 one groove (back side)		CCMA 0.7	CCMD 0.7
1 mm ² AWG 18 one groove		CCMA 1.0	CCMD 1.0
1,5 mm ² AWG 16 two grooves		CCMA 1.5	CCMD 1.5
2,5 mm ² AWG 14 three grooves		CCMA 2.5	CCMD 2.5
3 mm ² AWG 12 one wide groove		CCMA 3.0	CCMD 3.0
4 mm ² AWG 12 with no grooves		CCMA 4.0	CCMD 4.0
16A male crimp contacts for advanced opening			
0,5 mm ² AWG 20 with no grooves		CC 0.5 AN	* for basic or high thickness gold plating, please refer to page 675
0,75 mm ² AWG 18 one groove (back side)		CC 0.7 AN	
1 mm ² AWG 18 one groove		CC 1.0 AN	
1,5 mm ² AWG 16 two grooves		CC 1.5 AN	
2,5 mm ² AWG 14 three grooves		CC 2.5 AN	

- characteristics according to EN 61984:
16A 830V 8kV 3
16A 1000V 8kV 2
16A 720/1250V 8kV 2
- auxiliary contacts: **16A 500V 6kV 3**
- certified
- rated voltage according to UL/CSA: 600V
- insulation resistance: ≥ 10 GΩ
- ambient temperature limit: -40 °C ... +125 °C
- made of self-extinguishing thermoplastic resin UL 94V-0
- mechanical life: ≥ 500 cycles
- contact resistance: ≤ 1 mΩ
- for max. current load see the connector inserts derating diagram below; for more information see page 28

**CMCE 03 poles connector inserts
Maximum current load derating diagram**



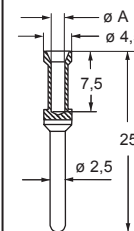
contacts side (front view)



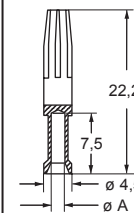
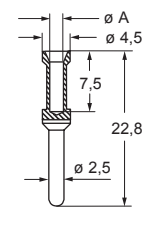
the auxiliary contacts are in the forward position upon opening

- it is recommended to crimp the contacts with crimping tools homologated by ILME (please see the crimping tool section 16A contacts, CCF, CCM and CC...AN series on pages 708 - 741)

CCF and CCM



CC...AN



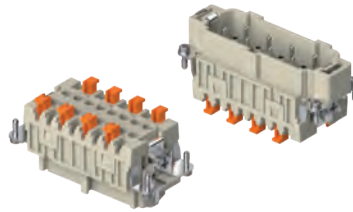
CCF, CCM and CC...AN contacts

conductor section mm ²	conductor slot ø A (mm)	conductors stripping length (mm)
0,14-0,37	0,9	7,5
0,5	1,1	7,5
0,75	1,3	7,5
1,0	1,45	7,5
1,5	1,8	7,5
2,5	2,2	7,5
3	2,55	7,5
4	2,85	7,5

CM SH-SQUICH® 6 + 2 (aux) poles + ⊕ 16A - 830V

enclosures: size "77.27"	page:
C-TYPE IP65 or IP66/IP69	402 - 411
C7 IP67, two levers	439 - 440
V-TYPE IP65 or IP66/IP69, single lever	454 - 458
BIG hoods	470 - 471
T-TYPE IP65 insulating	484 - 485
T-TYPE / W IP66/IP69 insulating	491
HYGIENIC T-TYPE / H IP66/IP69	503
HYGIENIC T-TYPE / C IP66/IP69, -50 °C	508
W-TYPE for aggressive environments	523
E-Xtreme® corrosion proof	534 - 535, 544, 554 - 555
EMC	580
Central lever	609 - 611
LS-TYPE	622 - 623
IP68	640 - 643
panel supports:	page:
COB	652 - 653

inserts,
spring terminal connection without tools



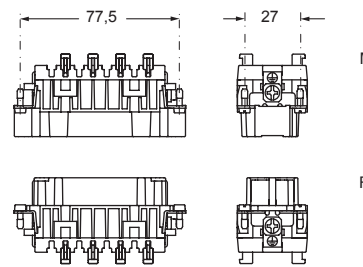
Q SILVER PLATED CONTACTS

description	part No.
-------------	----------

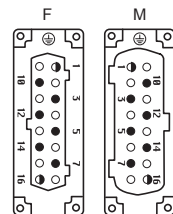
spring terminals with actuator button
female inserts with female contacts
male inserts with male contacts

CMSHF 06
CMSHM 06

- characteristics according to EN 61984:
16A 830V 8kV 3
16A 1000V 8kV 2
16A 720/1250V 8kV 2
- auxiliary contacts: **16A 500V 6kV 3**
- us (UL for USA and Canada), certified
- rated voltage according to UL/CSA: 600V
- insulation resistance: ≥ 10 GΩ
- ambient temperature limit: -40 °C ... +125 °C
- made of self-extinguishing thermoplastic resin UL 94V-0
- mechanical life: ≥ 500 cycles
- contact resistance: ≤ 3 mΩ
- for max. current load see the connector inserts derating diagram below; for more information see page 28



contacts side (front view)

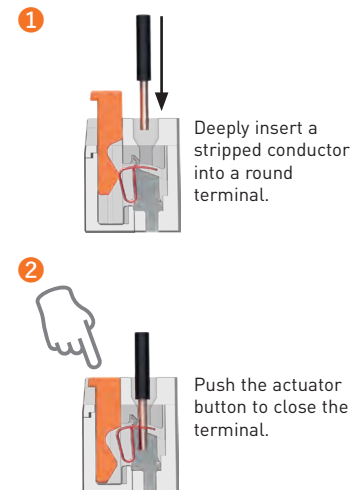


● the auxiliary contacts are in the forward position upon opening

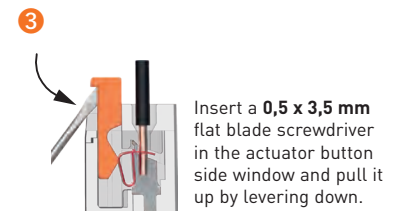
- inserts for section conductors:
0,14 - 2,5 mm² - AWG 26 - 14
- conductors stripping length: 9...11 mm

SQUICH®-spring connection technology

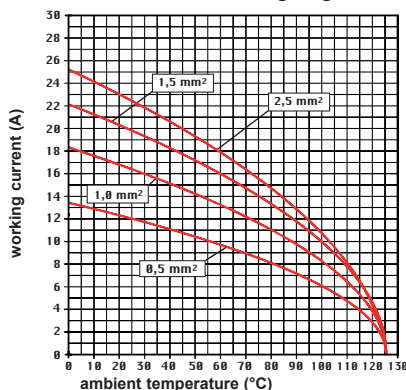
WIRING



RE-OPENING



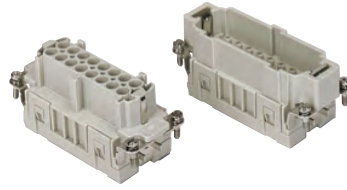
CM SH 06 poles connector inserts
Maximum current load derating diagram



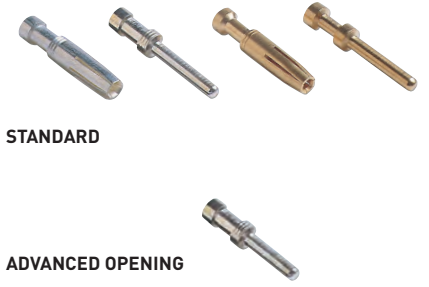
CMCE 6 + 2 (aux) poles + ⊕ 16A - 830V

enclosures: size "77.27"	page:
C-TYPE IP65 or IP66/IP69	402 - 411
C7 IP67, two levers	439 - 440
V-TYPE IP65 or IP66/IP69, single lever	454 - 458
BIG hoods	470 - 471
T-TYPE IP65 insulating	484 - 485
T-TYPE / W IP66/IP69 insulating	491
HYGIENIC T-TYPE / H IP66/IP69	503
HYGIENIC T-TYPE / C IP66/IP69, -50 °C	508
W-TYPE for aggressive environments	523
E-Xtreme® corrosion proof	534 - 535, 544, 554 - 555
EMC	580
Central lever	609 - 611
LS-TYPE	622 - 623
IP68	640 - 643
panel supports: COB	page: 652 - 653

inserts, crimp connections



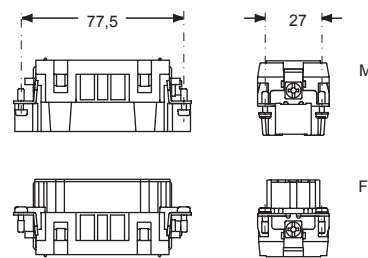
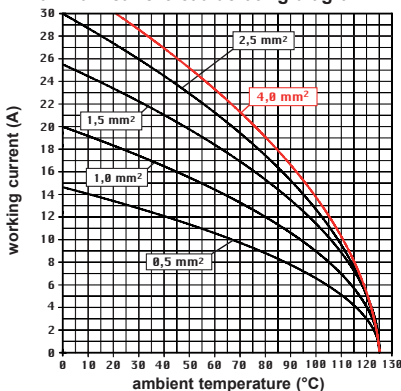
16A crimp contacts standard or for advanced opening silver and gold plated



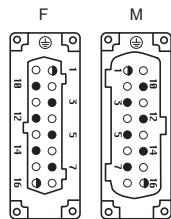
description	part No.	part No.	part No.
without contacts (to be ordered separately)	CMCEF 06		
female inserts for female contacts	CMCEM 06		
male inserts for male contacts			
16A female contacts			
0,14-0,37 mm ² AWG 26-22 one groove		CCFA 0.3	CCFD 0.3
0,5 mm ² AWG 20 with no grooves		CCFA 0.5	CCFD 0.5
0,75 mm ² AWG 18 one groove (back side)		CCFA 0.7	CCFD 0.7
1 mm ² AWG 18 one groove		CCFA 1.0	CCFD 1.0
1,5 mm ² AWG 16 two grooves		CCFA 1.5	CCFD 1.5
2,5 mm ² AWG 14 three grooves		CCFA 2.5	CCFD 2.5
3 mm ² AWG 12 one wide groove		CCFA 3.0	CCFD 3.0
4 mm ² AWG 12 with no grooves		CCFA 4.0	CCFD 4.0
16A male contacts			
0,14-0,37 mm ² AWG 26-22 one groove		CCMA 0.3	CCMD 0.3
0,5 mm ² AWG 20 with no grooves		CCMA 0.5	CCMD 0.5
0,75 mm ² AWG 18 one groove (back side)		CCMA 0.7	CCMD 0.7
1 mm ² AWG 18 one groove		CCMA 1.0	CCMD 1.0
1,5 mm ² AWG 16 two grooves		CCMA 1.5	CCMD 1.5
2,5 mm ² AWG 14 three grooves		CCMA 2.5	CCMD 2.5
3 mm ² AWG 12 one wide groove		CCMA 3.0	CCMD 3.0
4 mm ² AWG 12 with no grooves		CCMA 4.0	CCMD 4.0
16A male crimp contacts for advanced opening			
0,5 mm ² AWG 20 with no grooves		CC 0.5 AN	* for basic or high thickness gold plating, please refer to page 675
0,75 mm ² AWG 18 one groove (back side)		CC 0.7 AN	
1 mm ² AWG 18 one groove		CC 1.0 AN	
1,5 mm ² AWG 16 two grooves		CC 1.5 AN	
2,5 mm ² AWG 14 three grooves		CC 2.5 AN	

- characteristics according to EN 61984:
16A 830V 8kV 3
16A 1000V 8kV 2
16A 720/1250V 8kV 2
- auxiliary contacts: **16A 500V 6kV 3**
- certified
- rated voltage according to UL/CSA: 600V
- insulation resistance: ≥ 10 GΩ
- ambient temperature limit: -40 °C ... +125 °C
- made of self-extinguishing thermoplastic resin UL 94V-0
- mechanical life: ≥ 500 cycles
- contact resistance: ≤ 1 mΩ
- for max. current load see the connector inserts derating diagram below; for more information see page 28

CMCE 06 poles connector inserts
Maximum current load derating diagram



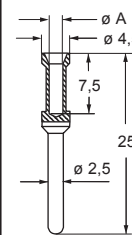
contacts side (front view)



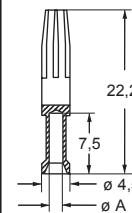
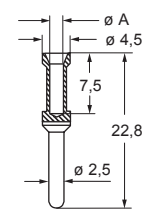
the auxiliary contacts are in the forward position upon opening

- it is recommended to crimp the contacts with crimping tools homologated by ILME (please see the crimping tool section 16A contacts, CCF, CCM and CC...AN series on pages 708 - 741)

CCF and CCM



CC...AN



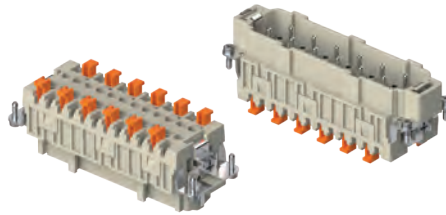
CCF, CCM and CC...AN contacts

conductor section mm ²	conductor slot Ø A (mm)	conductors stripping length (mm)
0,14-0,37	0,9	7,5
0,5	1,1	7,5
0,75	1,3	7,5
1,0	1,45	7,5
1,5	1,8	7,5
2,5	2,2	7,5
3	2,55	7,5
4	2,85	7,5

CMSH-SQUICH® 10 + 2 (aux) poles + ⊕ 16A - 830V

enclosures: size "104.27"	page:
C-TYPE IP65 or IP66/IP69	412 - 423
C7 IP67, two levers	441 - 442
V-TYPE IP65 or IP66/IP69, single lever	459 - 463
BIG hoods	472 - 473
T-TYPE IP65 insulating	486 - 487
T-TYPE / W IP66/IP69 insulating	492
HYGIENIC T-TYPE / H IP66/IP69	504
HYGIENIC T-TYPE / C IP66/IP69, -50 °C	509
W-TYPE for aggressive environments	524
E-Xtreme® corrosion proof	536 - 537, 545, 556 - 557
EMC	581
Central lever	612 - 614
LS-TYPE	624 - 625
IP68	644 - 647
panel supports:	page:
COB	652 - 653

inserts,
spring terminal connection without tools



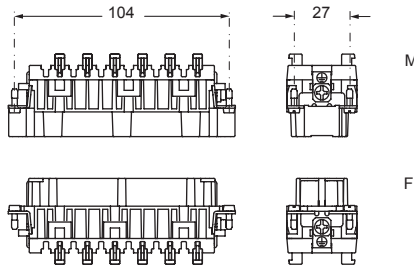
Q SILVER PLATED CONTACTS

description	part No.
-------------	----------

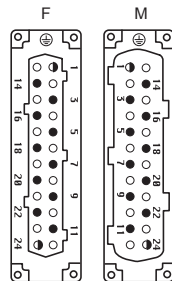
spring terminals with actuator button
female inserts with female contacts
male inserts with male contacts

CMSHF 10
CMSHM 10

- characteristics according to EN 61984:
16A 830V 8kV 3
16A 1000V 8kV 2
16A 720/1250V 8kV 2
- auxiliary contacts: **16A 500V 6kV 3**
- certified
- rated voltage according to UL/CSA: 600V
- insulation resistance: ≥ 10 GΩ
- ambient temperature limit: -40 °C ... +125 °C
- made of self-extinguishing thermoplastic resin UL 94V-0
- mechanical life: ≥ 500 cycles
- contact resistance: ≤ 3 mΩ
- for max. current load see the connector inserts derating diagram below; for more information see page 28



contacts side (front view)

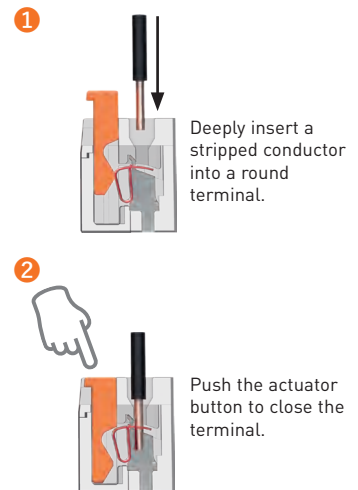


the auxiliary contacts are in the forward position upon opening

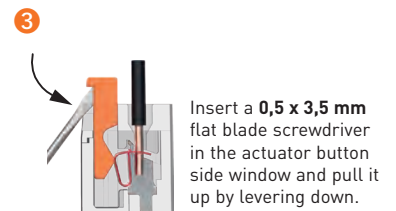
- inserts for section conductors: 0,14 - 2,5 mm² - AWG 26 - 14
- conductors stripping length: 9...11 mm

SQUICH®-spring connection technology

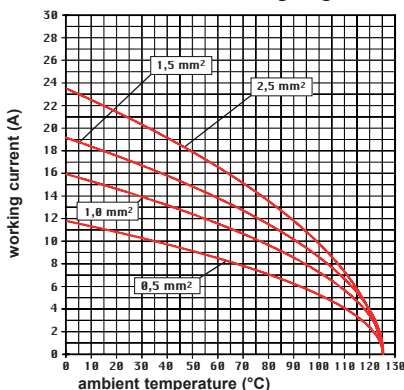
WIRING



RE-OPENING



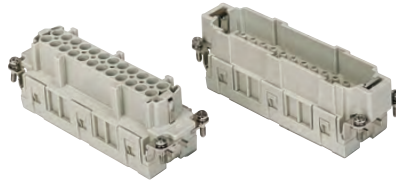
CMSH 10 poles connector inserts
Maximum current load derating diagram



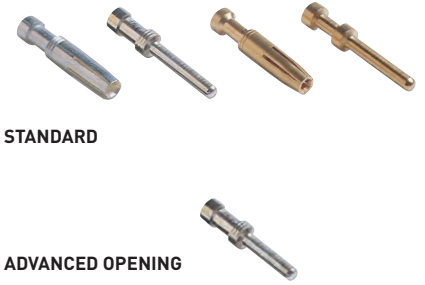
CMCE 10 + 2 (aux) poles + ⊕ 16A - 830V

enclosures: size "104.27"	page:
C-TYPE IP65 or IP66/IP69	412 - 423
C7 IP67, two levers	441 - 442
V-TYPE IP65 or IP66/IP69, single lever	459 - 463
BIG hoods	472 - 473
T-TYPE IP65 insulating	486 - 487
T-TYPE / W IP66/IP69 insulating	492
HYGIENIC T-TYPE / H IP66/IP69	504
HYGIENIC T-TYPE / C IP66/IP69, -50 °C	509
W-TYPE for aggressive environments	524
E-Xtreme® corrosion proof	536 - 537, 545, 556 - 557
EMC	581
Central lever	612 - 614
LS-TYPE	624 - 625
IP68	644 - 647
panel supports:	page:
COB	652 - 653

inserts, crimp connections



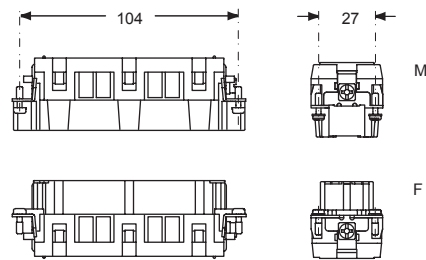
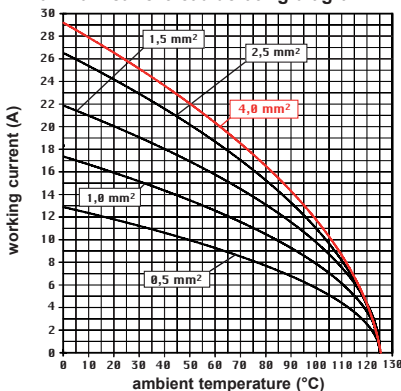
16A crimp contacts
standard or for advanced opening
silver and gold plated



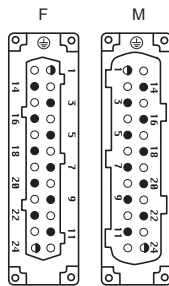
description	part No.	part No.	part No.
without contacts (to be ordered separately)			
female inserts for female contacts	CMCEF 10		
male inserts for male contacts	CMCEM 10		
16A female contacts			
0,14-0,37 mm ² AWG 26-22 one groove		CCFA 0.3	CCFD 0.3
0,5 mm ² AWG 20 with no grooves		CCFA 0.5	CCFD 0.5
0,75 mm ² AWG 18 one groove (back side)		CCFA 0.7	CCFD 0.7
1 mm ² AWG 18 one groove		CCFA 1.0	CCFD 1.0
1,5 mm ² AWG 16 two grooves		CCFA 1.5	CCFD 1.5
2,5 mm ² AWG 14 three grooves		CCFA 2.5	CCFD 2.5
3 mm ² AWG 12 one wide groove		CCFA 3.0	CCFD 3.0
4 mm ² AWG 12 with no grooves		CCFA 4.0	CCFD 4.0
16A male contacts			
0,14-0,37 mm ² AWG 26-22 one groove		CCMA 0.3	CCMD 0.3
0,5 mm ² AWG 20 with no grooves		CCMA 0.5	CCMD 0.5
0,75 mm ² AWG 18 one groove (back side)		CCMA 0.7	CCMD 0.7
1 mm ² AWG 18 one groove		CCMA 1.0	CCMD 1.0
1,5 mm ² AWG 16 two grooves		CCMA 1.5	CCMD 1.5
2,5 mm ² AWG 14 three grooves		CCMA 2.5	CCMD 2.5
3 mm ² AWG 12 one wide groove		CCMA 3.0	CCMD 3.0
4 mm ² AWG 12 with no grooves		CCMA 4.0	CCMD 4.0
16A male crimp contacts for advanced opening			
0,5 mm ² AWG 20 with no grooves		CC 0.5 AN	* for basic or high thickness gold plating, please refer to page 675
0,75 mm ² AWG 18 one groove (back side)		CC 0.7 AN	
1 mm ² AWG 18 one groove		CC 1.0 AN	
1,5 mm ² AWG 16 two grooves		CC 1.5 AN	
2,5 mm ² AWG 14 three grooves		CC 2.5 AN	

- characteristics according to EN 61984:
16A 830V 8kV 3
16A 1000V 8kV 2
16A 720/1250V 8kV 2
- auxiliary contacts: **16A 500V 6kV 3**
- certified
- rated voltage according to UL/CSA: 600V
- insulation resistance: ≥ 10 GΩ
- ambient temperature limit: -40 °C ... +125 °C
- made of self-extinguishing thermoplastic resin UL 94V-0
- mechanical life: ≥ 500 cycles
- contact resistance: ≤ 1 mΩ
- for max. current load see the connector inserts derating diagram below; for more information see page 28

CMCE 10 poles connector inserts
Maximum current load derating diagram

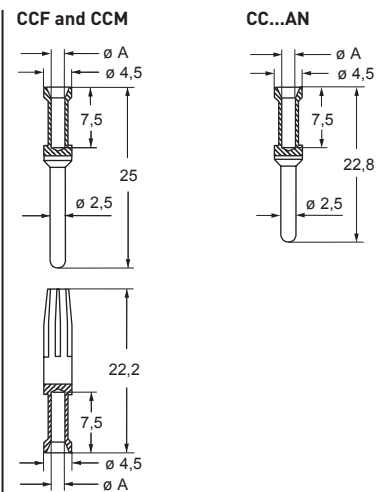


contacts side (front view)



the auxiliary contacts are in the forward position upon opening

- it is recommended to crimp the contacts with crimping tools homologated by ILME (please see the crimping tool section 16A contacts, CCF, CCM and CC...AN series on pages 708 - 741)



CCF, CCM and CC...AN contacts

conductor section mm ²	conductor slot Ø A (mm)	conductors stripping length (mm)
0,14-0,37	0,9	7,5
0,5	1,1	7,5
0,75	1,3	7,5
1,0	1,45	7,5
1,5	1,8	7,5
2,5	2,2	7,5
3	2,55	7,5
4	2,85	7,5

CMSH-SQUICH® 12 + 4 (aux) poles + ⊕ 16A - 830V

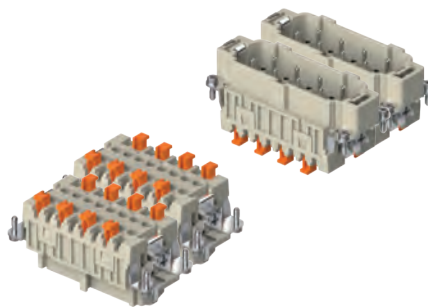
enclosures:
size "77.62"

page:

C-TYPE IP65 or IP66/IP69
W-TYPE for aggressive environments
E-Xtreme® corrosion proof

424 - 429
525
546

inserts,
spring terminal connection without tools



Q SILVER PLATED CONTACTS

description	part No.	part No.
-------------	----------	----------

spring terminals with actuator button
female inserts with female contacts, No. (1-16) and (17-32)
male inserts with male contacts, No. (1-16) and (17-32)

CMSHF 06
CMSHM 06

CMSHF 06 N
CMSHM 06 N

- characteristics according to EN 61984:

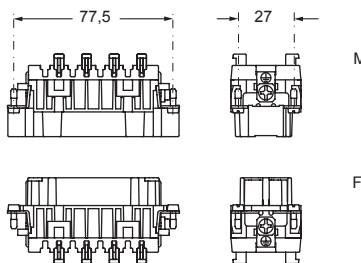
- 16A 830V 8kV 3**
- 16A 1000V 8kV 2**
- 16A 720/1250V 8kV 2**

- auxiliary contacts: **16A 500V 6kV 3**

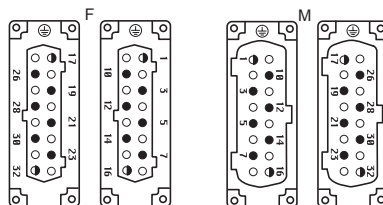
- us (UL for USA and Canada), BUREAU VERITAS

ERC certified

- rated voltage according to UL/CSA: 600V
- insulation resistance: $\geq 10 \text{ G}\Omega$
- ambient temperature limit: $-40 \text{ }^\circ\text{C} \dots +125 \text{ }^\circ\text{C}$
- made of self-extinguishing thermoplastic resin UL 94V-0
- mechanical life: ≥ 500 cycles
- contact resistance: $\leq 3 \text{ m}\Omega$
- for max. current load see the connector inserts derating diagram below; for more information see page 28



contacts side (front view)

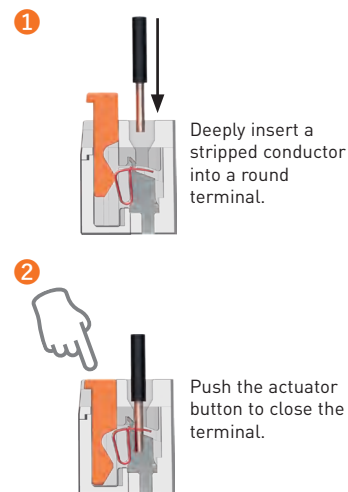


● the auxiliary contacts are in the forward position upon opening

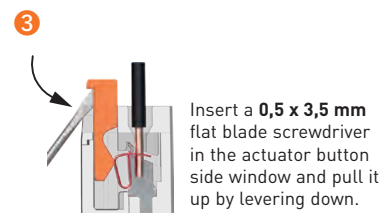
- inserts for section conductors: 0,14 - 2,5 mm² - AWG 26 - 14
- conductors stripping length: 9...11 mm

SQUICH®-spring connection technology

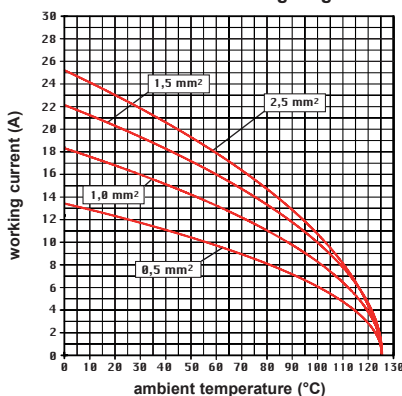
WIRING



RE-OPENING



CMSH 12 poles connector inserts
Maximum current load derating diagram



CMCE 12 + 4 (aux) poles + ⊕ 16A - 830V

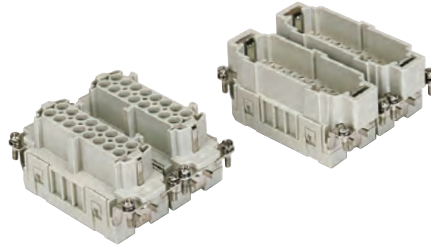
enclosures:
size "77.62"

page:

C-TYPE IP65 or IP66/IP69
W-TYPE for aggressive environments
E-Xtreme® corrosion proof

424 - 429
525
546

inserts, crimp connections



16A crimp contacts standard or for advanced opening silver and gold plated



STANDARD

ADVANCED OPENING

description	part No.	part No.	part No.	part No.
without contacts (to be ordered separately)				
female inserts for female contacts, No. (1-16) and (17-32)	CMCEF 06	CMCEF 06 N		
male inserts for male contacts, No. (1-16) and (17-32)	CMCEM 06	CMCEM 06 N		
16A female contacts				
0,14-0,37 mm ² AWG 26-22 one groove			CCFA 0.3	CCFD 0.3
0,5 mm ² AWG 20 with no grooves			CCFA 0.5	CCFD 0.5
0,75 mm ² AWG 18 one groove (back side)			CCFA 0.7	CCFD 0.7
1 mm ² AWG 18 one groove			CCFA 1.0	CCFD 1.0
1,5 mm ² AWG 16 two grooves			CCFA 1.5	CCFD 1.5
2,5 mm ² AWG 14 three grooves			CCFA 2.5	CCFD 2.5
3 mm ² AWG 12 one wide groove			CCFA 3.0	CCFD 3.0
4 mm ² AWG 12 with no grooves			CCFA 4.0	CCFD 4.0
16A male contacts				
0,14-0,37 mm ² AWG 26-22 one groove			CCMA 0.3	CCMD 0.3
0,5 mm ² AWG 20 with no grooves			CCMA 0.5	CCMD 0.5
0,75 mm ² AWG 18 one groove (back side)			CCMA 0.7	CCMD 0.7
1 mm ² AWG 18 one groove			CCMA 1.0	CCMD 1.0
1,5 mm ² AWG 16 two grooves			CCMA 1.5	CCMD 1.5
2,5 mm ² AWG 14 three grooves			CCMA 2.5	CCMD 2.5
3 mm ² AWG 12 one wide groove			CCMA 3.0	CCMD 3.0
4 mm ² AWG 12 with no grooves			CCMA 4.0	CCMD 4.0
16A male crimp contacts for advanced opening				
0,5 mm ² AWG 20 with no grooves			CC 0.5 AN	* for basic or high thickness gold plating, please refer to page 675
0,75 mm ² AWG 18 one groove (back side)			CC 0.7 AN	
1 mm ² AWG 18 one groove			CC 1.0 AN	
1,5 mm ² AWG 16 two grooves			CC 1.5 AN	
2,5 mm ² AWG 14 three grooves			CC 2.5 AN	

- characteristics according to EN 61984:

16A 830V 8kV 3
16A 1000V 8kV 2
16A 720/1250V 8kV 2
- auxiliary contacts: **16A 500V 6kV 3**

- certified

- rated voltage according to UL/CSA: 600V

- insulation resistance: ≥ 10 GΩ

- ambient temperature limit: -40 °C ... +125 °C

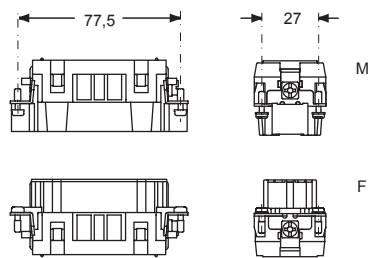
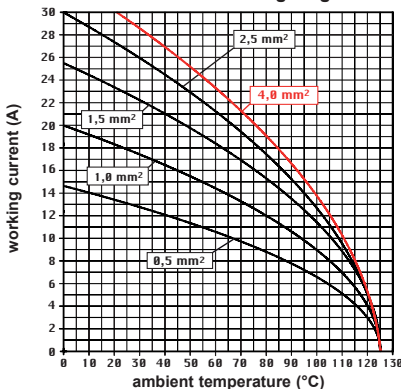
- made of self-extinguishing thermoplastic resin UL 94V-0

- mechanical life: ≥ 500 cycles

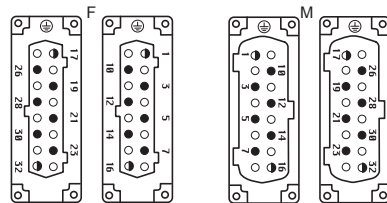
- contact resistance: ≤ 1 mΩ

- for max. current load see the connector inserts derating diagram below; for more information see page 28

CMCE 12 poles connector inserts
Maximum current load derating diagram



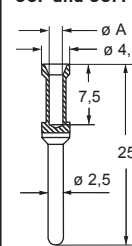
contacts side (front view)



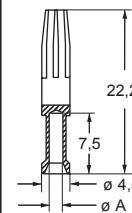
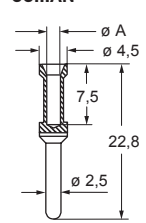
● the auxiliary contacts are in the forward position upon opening

- it is recommended to crimp the contacts with crimping tools homologated by ILME (please see the crimping tool section 16A contacts, CCF, CCM and CC...AN series on pages 708 - 741)

CCF and CCM



CC...AN



CCF, CCM and CC...AN contacts

conductor section mm ²	conductor slot Ø A (mm)	conductors stripping length (mm)
0,14-0,37	0,9	7,5
0,5	1,1	7,5
0,75	1,3	7,5
1,0	1,45	7,5
1,5	1,8	7,5
2,5	2,2	7,5
3	2,55	7,5
4	2,85	7,5

CMSH-SQUICH® 20 + 4 (aux) poles + ⊕ 16A - 830V

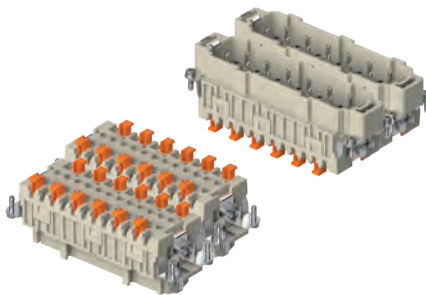
enclosures:
size "104.62"

page:

C-TYPE IP65 or IP66/IP69
W-TYPE for aggressive environments
E-Xtreme® corrosion proof

430
526
547

inserts,
spring terminal connection without tools



Q SILVER PLATED CONTACTS

description	part No.	part No.
-------------	----------	----------

spring terminals with actuator button
female inserts with female contacts, No. (1-24) and (25-48)
male inserts with male contacts, No. (1-24) and (25-48)

CMSHF 10
CMSHM 10

CMSHF 10 N
CMSHM 10 N

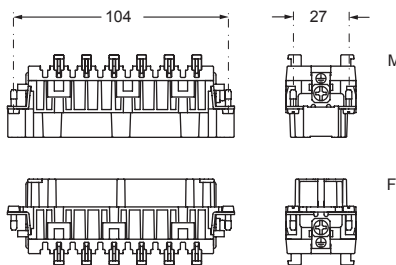
- characteristics according to EN 61984:

- 16A 830V 8kV 3
- 16A 1000V 8kV 2
- 16A 720/1250V 8kV 2
- auxiliary contacts: 16A 500V 6kV 3

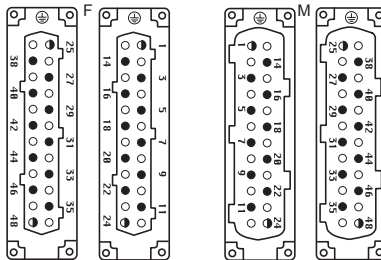
- cULus (UL for USA and Canada), DNV-GL, BUREAU VERITAS

ERC certified

- rated voltage according to UL/CSA: 600V
- insulation resistance: $\geq 10 \text{ G}\Omega$
- ambient temperature limit: $-40 \text{ }^\circ\text{C} \dots +125 \text{ }^\circ\text{C}$
- made of self-extinguishing thermoplastic resin UL 94V-0
- mechanical life: ≥ 500 cycles
- contact resistance: $\leq 3 \text{ m}\Omega$
- for max. current load see the connector inserts derating diagram below; for more information see page 28



contacts side (front view)

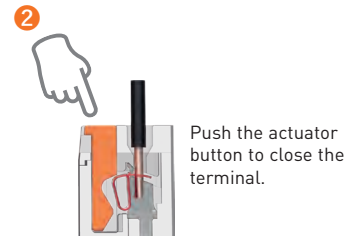
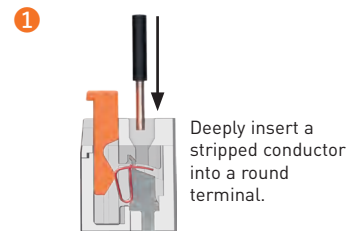


● the auxiliary contacts are in the forward position upon opening

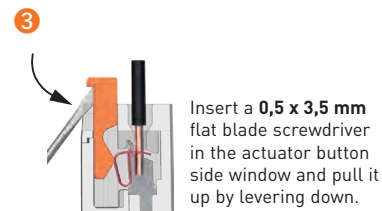
- inserts for section conductors: 0,14 - 2,5 mm² - AWG 26 - 14
- conductors stripping length: 9...11 mm

SQUICH®-spring connection technology

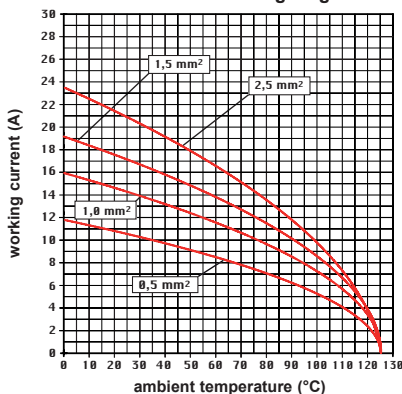
WIRING



RE-OPENING



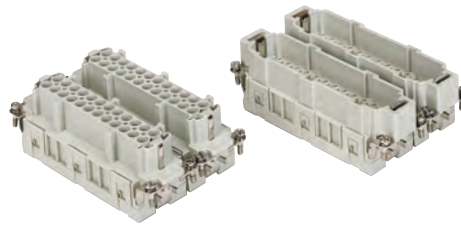
CMSH 20 poles connector inserts
Maximum current load derating diagram



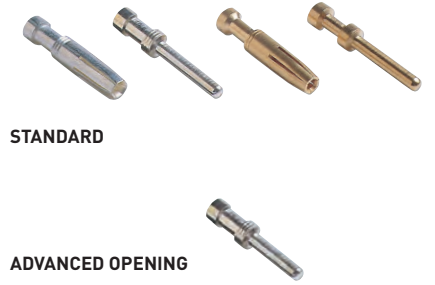
CMCE 20 + 4 (aux) poles + ⊕ 16A - 830V

enclosures:
size "104.62" page: 430
C-TYPE IP65 or IP66/IP69 526
W-TYPE for aggressive environments 547
E-Xtreme® corrosion proof 547

inserts, crimp connections



16A crimp contacts
standard or for advanced opening
silver and gold plated



description	part No.	part No.	part No.
without contacts (to be ordered separately)			
female inserts for female contacts, No. (1-24) and (25-48)	CMCEF 10	CMCEF 10 N	
male inserts for male contacts, No. (1-24) and (25-48)	CMCEM 10	CMCEM 10 N	
16A female contacts			
0,14-0,37 mm ² AWG 26-22 one groove			CCFA 0.3
0,5 mm ² AWG 20 with no grooves			CCFA 0.5
0,75 mm ² AWG 18 one groove (back side)			CCFA 0.7
1 mm ² AWG 18 one groove			CCFA 1.0
1,5 mm ² AWG 16 two grooves			CCFA 1.5
2,5 mm ² AWG 14 three grooves			CCFA 2.5
3 mm ² AWG 12 one wide groove			CCFA 3.0
4 mm ² AWG 12 with no grooves			CCFA 4.0
16A male contacts			
0,14-0,37 mm ² AWG 26-22 one groove			CCMA 0.3
0,5 mm ² AWG 20 with no grooves			CCMA 0.5
0,75 mm ² AWG 18 one groove (back side)			CCMA 0.7
1 mm ² AWG 18 one groove			CCMA 1.0
1,5 mm ² AWG 16 two grooves			CCMA 1.5
2,5 mm ² AWG 14 three grooves			CCMA 2.5
3 mm ² AWG 12 one wide groove			CCMA 3.0
4 mm ² AWG 12 with no grooves			CCMA 4.0
16A male crimp contacts for advanced opening			
0,5 mm ² AWG 20 with no grooves			CC 0.5 AN
0,75 mm ² AWG 18 one groove (back side)			CC 0.7 AN
1 mm ² AWG 18 one groove			CC 1.0 AN
1,5 mm ² AWG 16 two grooves			CC 1.5 AN
2,5 mm ² AWG 14 three grooves			CC 2.5 AN

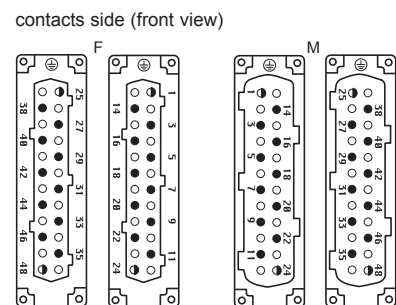
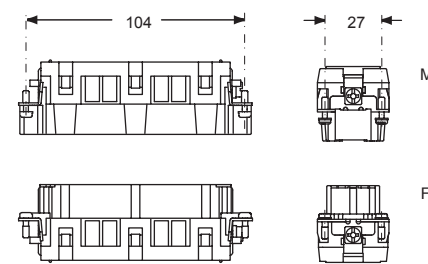
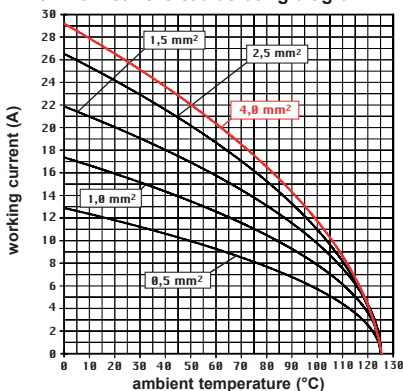
silver plated

gold plated*

* for basic or high thickness gold plating, please refer to page 675

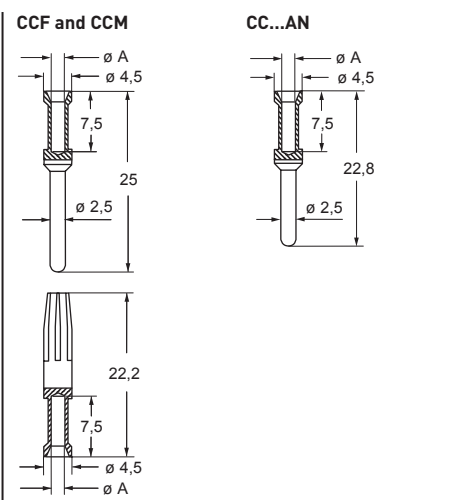
- characteristics according to EN 61984:
- 16A 830V 8kV 3**
- 16A 1000V 8kV 2**
- 16A 720/1250V 8kV 2**
- auxiliary contacts: **16A 500V 6kV 3**
- certified
- rated voltage according to UL/CSA: 600V
- insulation resistance: ≥ 10 GΩ
- ambient temperature limit: -40 °C ... +125 °C
- made of self-extinguishing thermoplastic resin UL 94V-0
- mechanical life: ≥ 500 cycles
- contact resistance: ≤ 1 mΩ
- for max. current load see the connector inserts derating diagram below; for more information see page 28

CMCE 20 poles connector inserts
Maximum current load derating diagram



the auxiliary contacts are in the forward position upon opening

- it is recommended to crimp the contacts with crimping tools homologated by ILME (please see the crimping tool section 16A contacts, CCF, CCM and CC...AN series on pages 708 - 741)



CCF, CCM and CC...AN contacts		
conductor section mm ²	conductor slot Ø A (mm)	conductors stripping length (mm)
0,14-0,37	0,9	7,5
0,5	1,1	7,5
0,75	1,3	7,5
1,0	1,45	7,5
1,5	1,8	7,5
2,5	2,2	7,5
3	2,55	7,5
4	2,85	7,5

CSS series

Connection with dual spring terminal per pole

Series **CSS** is the “two spring clamp terminal per contact” counterpart of series **CSH** connectors, which have one spring-clamp terminal per contact.

 CSS connection technology see page 23

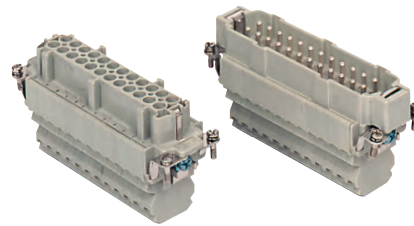
In series **CSS** inserts **are made available to the user with two spring clamp terminals per contact** so that two conductors can be connected to each of them.

Series **CSS** inserts share the mating interface (dimensions) with equally sized inserts of series **CNE** (screw-type) **CCE** (crimp type) **CSH** (spring-type with actuator button SQUICH®), **CT** (screw-type with 45° terminal block) and **CTSE** (spring-type with 45° terminal block).

With connectors like **CSS** and suitably developed housings, electric motors can be prepared for the fastest and safest installation. The motor terminal box may be replaced by the specially developed motor connection angled housing **CVI 10 LA** or **MVI 10 LAP32** (see page 450). The “57.27” size for the connector insert and the housing has been chosen to fulfil motor connection requirements.

Star or delta (triangle) bridges may be realized in the mating (free) female connector, realizing simple bridges thanks to the double terminals per pole feature of **CSS**, by short conductors stripped at both ends and “U-bent”. Fast and easy exchange of a motor for maintenance is made easy, reducing costs for downtime.

* DESINA standards for **DE**centralized and **St**andardized **IN**stall**A**ction Technology. This working group was founded by the Association of German Machine Tools Manufacturers (VDW) with the target to develop a field bus independent, standardized installation system for machines and production plants. The task was fulfilled in close cooperation with machine tools manufacturers, the automotive industry and their supply chain. **DESINA** specifications have been transferred to series **ISO 22570** international standards.



SUM-UP

- Two spring clamp terminals per contact**
- No special tools are needed**
- Suitable for standard hoods/housings size “44.27”, “57.27”, “77.27”, “77.62”, “104.27”, “104.62” high construction version**
- Vibration and shock resistant**
- Ideal as motor connectors, as they provide the possibility to connect motor windings in star and delta configuration**
- The 10 pole version is specified by **DESINA** Specifications* and by ISO 22570-1:2009 as type 1 connector for motor connection (6 poles for three-phase star or delta connection + 2 poles for breaking circuit + 2 poles for temperature sensing motor protection circuit)**
- Built-in silver plated contacts**

CSS series

TECHNICAL FEATURES

Insert series		CSS
No. of poles ¹⁾	Main contacts + ⊕	6, 10, 16, 24, (32 = 2x16), (48 = 2x24)
	auxiliary contacts	—
Rated current ²⁾		16A
EN IEC 61984 Pollution degree 3	rated voltage	500V
	rated impulse voltage	6kV
	pollution degree	3
EN IEC 61984 Pollution degree 2	rated voltage	400/690V
	rated impulse voltage	6kV
	pollution degree	2
UL / CSA certification	rated voltage (a.c./d.c.)	600V
Contact resistance		≤ 3 mΩ
Insulation resistance		≥ 10 GΩ
Ambient temperature limit (°C)	min	-40 °C
	max	+125 °C
Degree of protection	with enclosures	IP65, IP66/IP69, IP66/IP67/IP69, IP66/IP68/IP69 (according to type and model)
	without enclosures (in mated condition) - termination side on male and female inserts - mating side on female inserts	IP20 (IPXXB)
Conductor connections		spring type
Conductor cross-sectional area	mm ²	0,14 - 2,5
	AWG	26 - 14
Mechanical endurance (mating cycles)		≥ 500

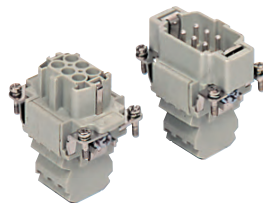
1) Polarities shown in brackets may be obtained by using two inserts in their own double-sized housings

2) Please check the inserts derating diagrams to establish the actual maximum operating current according to the ambient temperature, the conductor cross-sectional area, the polarity of the connector, and any external constraint may derive e.g. by the continuous operating temperature sustained by the chosen conductor sheathing or by end-product safety standards fixing max allowed temperature rise on terminals (e.g. 30 K, 45 K or 50 K)

CSS 6 poles + ⊕ 16A - 500V

enclosures: size "44.27"	page:
C-TYPE IP65 or IP66/IP69	387 - 392
C7 IP67, single lever	436 - 437
V-TYPE IP65 or IP66/IP69, single lever	444 - 447
BIG hoods	466 - 467
T-TYPE IP65 insulating	480 - 481
T-TYPE / W IP66/IP69 insulating	489
HYGIENIC T-TYPE / H IP66/IP69	501
HYGIENIC T-TYPE / C IP66/IP69, -50 °C	506
W-TYPE for aggressive environments	521
E-Xtreme® corrosion proof	530 - 531, 542, 550 - 551
EMC	578
Central lever	603 - 605
LS-TYPE	618 - 619
IP68	632 - 635
panel supports:	page:
COB	652 - 653

inserts,
connection with dual spring
terminal per pole



can be mated with CNE, CCE, CTSE, CSH inserts

description	part No.
-------------	----------

dual spring terminal per pole
female inserts with female contacts
male inserts with male contacts

CSSF 06
CSSM 06

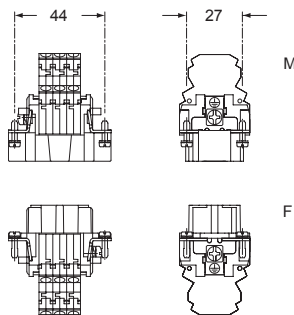
The CSS series inserts can be inserted in flush mounted enclosures or in fixed / portable high enclosures.

- characteristics according to EN 61984:

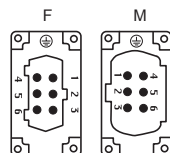
16A 500V 6kV 3
16A 400/690V 6kV 2

- certified

- rated voltage according to UL/CSA: 600V
- insulation resistance: $\geq 10 \text{ G}\Omega$
- ambient temperature limit: $-40 \text{ }^\circ\text{C} \dots +125 \text{ }^\circ\text{C}$
- made of self-extinguishing thermoplastic resin UL 94V-0
- mechanical life: ≥ 500 cycles
- contact resistance: $\leq 3 \text{ m}\Omega$
- for max. current load see the connector inserts derating diagram below; for more information see page 28

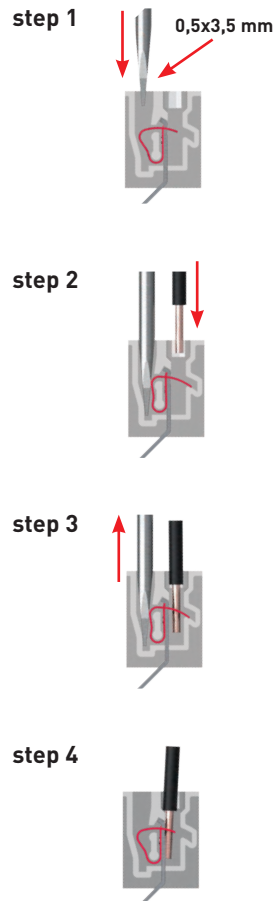


contacts side (front view)

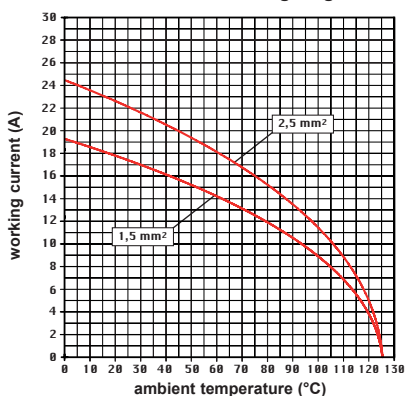


- inserts with plate for section conductors: 0,14 - 2,5 mm² - AWG 26 - 14
- conductors stripping length: 9...11 mm

Connection technology



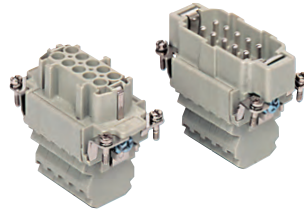
CSS 06 poles connector inserts
Maximum current load derating diagram



CSS 10 poles + ⊕ 16A - 500V

enclosures: size "57.27"	page:
C-TYPE IP65 or IP66/IP69	393 - 401
C7 IP67, two levers	438
V-TYPE IP65 or IP66/IP69, single lever	448 - 453
BIG hoods	468 - 469
T-TYPE IP65 insulating	482 - 483
T-TYPE / W IP66/IP69 insulating	490
HYGIENIC T-TYPE / H IP66/IP69	502
HYGIENIC T-TYPE / C IP66/IP69, -50 °C	507
W-TYPE for aggressive environments	522
E-Xtreme® corrosion proof	532 - 533, 543, 552 - 553
EMC	579
Central lever	606 - 608
LS-TYPE	620 - 621
IP68	636 - 639
panel supports: COB	page: 652 - 653

inserts,
connection with dual spring
terminal per pole



can be mated with CNE, CCE, CTSE, CSH inserts

description	part No.
-------------	----------

dual spring terminal per pole
female inserts with female contacts
male inserts with male contacts

CSSF 10
CSSM 10

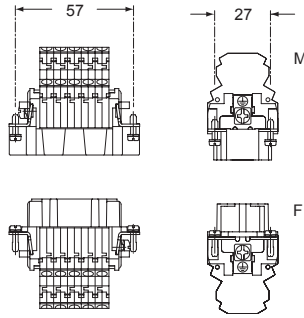
The CSS series inserts can be inserted in flush mounted enclosures or in fixed / portable high enclosures.

- characteristics according to EN 61984:

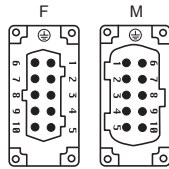
16A 500V 6kV 3
16A 400/690V 6kV 2

- certified

- rated voltage according to UL/CSA: 600V
- insulation resistance: $\geq 10 \text{ G}\Omega$
- ambient temperature limit: $-40 \text{ }^\circ\text{C} \dots +125 \text{ }^\circ\text{C}$
- made of self-extinguishing thermoplastic resin UL 94V-0
- mechanical life: ≥ 500 cycles
- contact resistance: $\leq 3 \text{ m}\Omega$
- for max. current load see the connector inserts derating diagram below; for more information see page 28

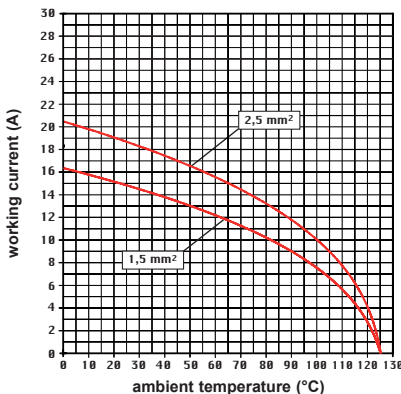


contacts side (front view)

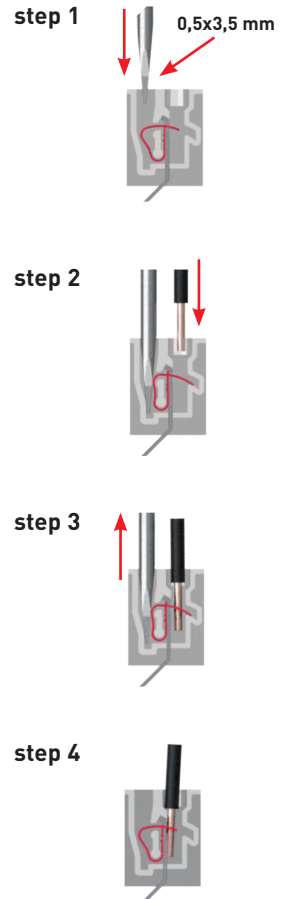


- inserts with plate for section conductors: 0,14 - 2,5 mm² - AWG 26 - 14
- conductors stripping length: 9...11 mm

CSS 10 poles connector inserts
Maximum current load derating diagram



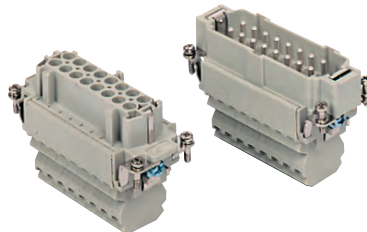
Connection technology



CSS 16 poles + ⊕ 16A - 500V

enclosures: size "77.27"	page:
C-TYPE IP65 or IP66/IP69	402 - 411
C7 IP67, two levers	439 - 440
V-TYPE IP65 or IP66/IP69, single lever	454 - 458
BIG hoods	470 - 471
T-TYPE IP65 insulating	484 - 485
T-TYPE / W IP66/IP69 insulating	491
HYGIENIC T-TYPE / H IP66/IP69	503
HYGIENIC T-TYPE / C IP66/IP69, -50 °C	508
W-TYPE for aggressive environments	523
E-Xtreme® corrosion proof	534 - 535, 544, 554 - 555
EMC	580
Central lever	609 - 611
LS-TYPE	622 - 623
IP68	640 - 643
panel supports:	page:
COB	652 - 653

inserts,
connection with dual spring
terminal per pole



can be mated with CNE, CCE, CTSE, CSH inserts

description	part No.
-------------	----------

dual spring terminal per pole
female inserts with female contacts
male inserts with male contacts

CSSF 16
CSSM 16

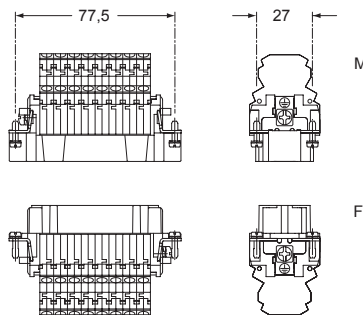
The CSS series inserts can be inserted in flush mounted enclosures or in fixed / portable high enclosures.

- characteristics according to EN 61984:

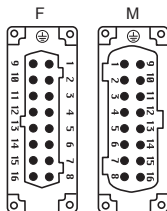
16A 500V 6kV 3
16A 400/690V 6kV 2

- certified

- rated voltage according to UL/CSA: 600V
- insulation resistance: $\geq 10 \text{ G}\Omega$
- ambient temperature limit: -40 °C ... +125 °C
- made of self-extinguishing thermoplastic resin UL 94V-0
- mechanical life: ≥ 500 cycles
- contact resistance: $\leq 3 \text{ m}\Omega$
- for max. current load see the connector inserts derating diagram below; for more information see page 28

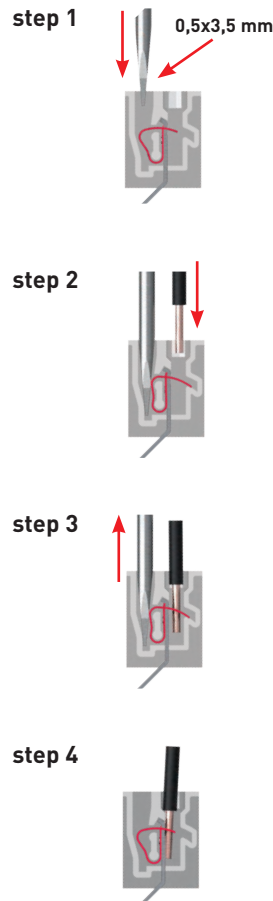


contacts side (front view)

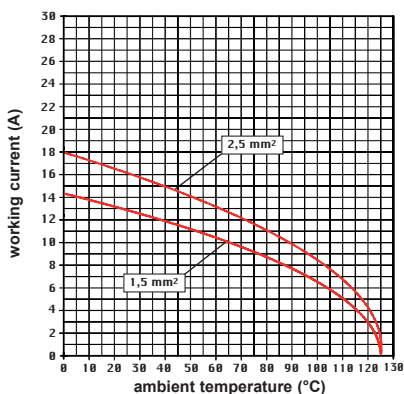


- inserts with plate for section conductors: 0,14 - 2,5 mm² - AWG 26 - 14
- conductors stripping length: 9...11 mm

Connection technology



CSS 16 poles connector inserts
Maximum current load derating diagram



CSS 24 poles + ⊕ 16A - 500V

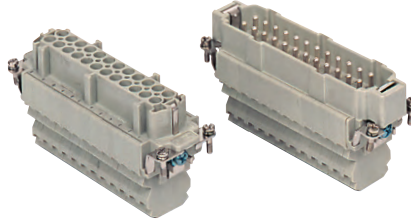
enclosures: size "104.27"	page:
C-TYPE IP65 or IP66/IP69	412 - 423
C7 IP67, two levers	441 - 442
V-TYPE IP65 or IP66/IP69, single lever	459 - 463
BIG hoods	472 - 473
T-TYPE IP65 insulating	486 - 487
T-TYPE / W IP66/IP69 insulating	492
HYGIENIC T-TYPE / H IP66/IP69	504
HYGIENIC T-TYPE / C IP66/IP69, -50 °C	509
W-TYPE for aggressive environments	524
E-Xtreme® corrosion proof	536 - 537, 545, 556 - 557
EMC	581
Central lever	612 - 614
LS-TYPE	624 - 625
IP68	644 - 647
panel supports:	page:
COB	652 - 653

can be mated with CNE, CCE, CTSE, CSH inserts

description	part No.
-------------	----------

dual spring terminal per pole
female inserts with female contacts
male inserts with male contacts

inserts,
connection with dual spring
terminal per pole



CSSF 24
CSSM 24

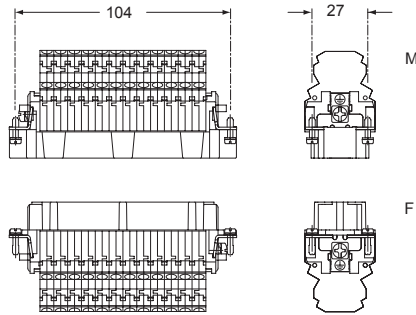
The CSS series inserts can be inserted in flush mounted enclosures or in fixed / portable high enclosures.

- characteristics according to EN 61984:

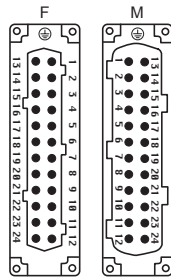
16A 500V 6kV 3
16A 400/690V 6kV 2

- certified

- rated voltage according to UL/CSA: 600V
- insulation resistance: ≥ 10 GΩ
- ambient temperature limit: -40 °C ... +125 °C
- made of self-extinguishing thermoplastic resin UL 94V-0
- mechanical life: ≥ 500 cycles
- contact resistance: ≤ 3 mΩ
- for max. current load see the connector inserts derating diagram below; for more information see page 28

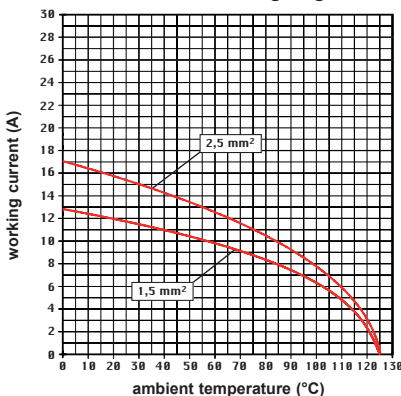


contacts side (front view)

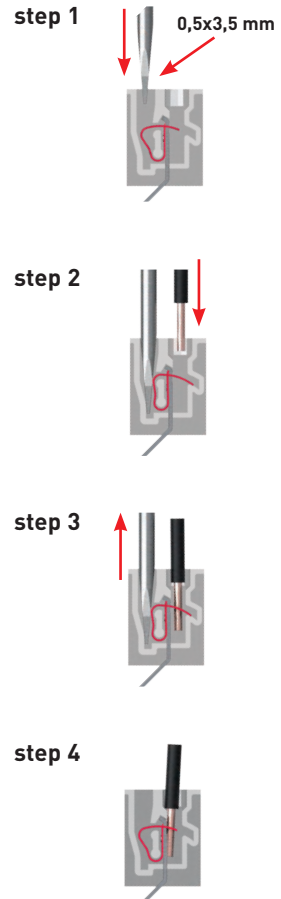


- inserts with plate for section conductors: 0,14 - 2,5 mm² - AWG 26 - 14
- conductors stripping length: 9...11 mm

CSS 24 poles connector inserts
Maximum current load derating diagram



Connection technology



CSS 32 poles + ⊕ 16A - 500V

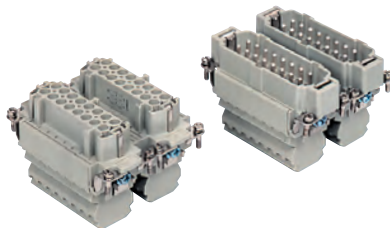
enclosures:
size "77.62"

page:

C-TYPE IP65 or IP66/IP69
W-TYPE for aggressive environments
E-Xtreme® corrosion proof

424 - 429
525
546

inserts,
connection with dual spring
terminal per pole



can be mated with CNE, CCE, CTSE, CSH inserts

description

part No.

part No.

dual spring terminal per pole
female inserts with female contacts, No. (1-16) and (17-32)
male inserts with male contacts, No. (1-16) and (17-32)

CSSF 16
CSSM 16

CSSF 16 N
CSSM 16 N

The CSS series inserts can be inserted in flush mounted enclosures or in fixed / portable high enclosures.

- characteristics according to EN 61984:

16A 500V 6kV 3

16A 400/690V 6kV 2

- certified

- rated voltage according to UL/CSA: 600V

- insulation resistance: $\geq 10 \text{ G}\Omega$

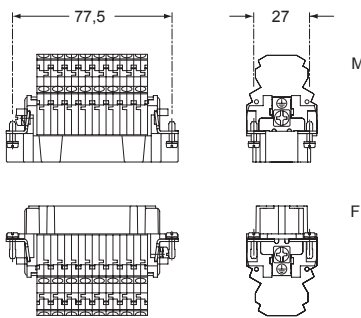
- ambient temperature limit: $-40 \text{ }^\circ\text{C} \dots +125 \text{ }^\circ\text{C}$

- made of self-extinguishing thermoplastic resin UL 94V-0

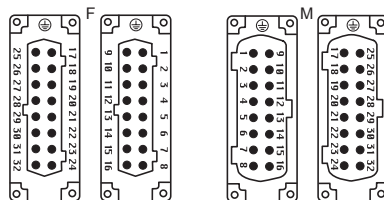
- mechanical life: ≥ 500 cycles

- contact resistance: $\leq 3 \text{ m}\Omega$

- for max. current load see the connector inserts derating diagram below; for more information see page 28



contacts side (front view)



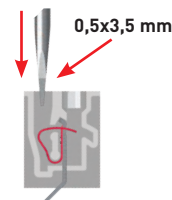
- inserts with plate for section conductors:

0,14 - 2,5 mm² - AWG 26 - 14

- conductors stripping length: 9...11 mm

Connection technology

step 1



step 2



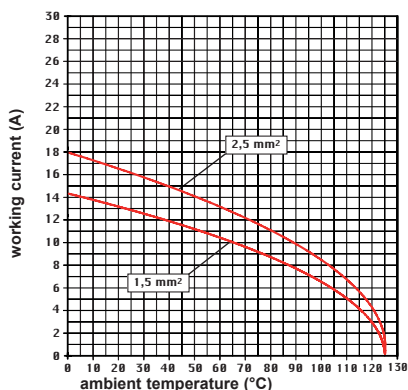
step 3



step 4



CSS 32 poles connector inserts
Maximum current load derating diagram



CSS 48 poles + ⊕ 16A - 500V

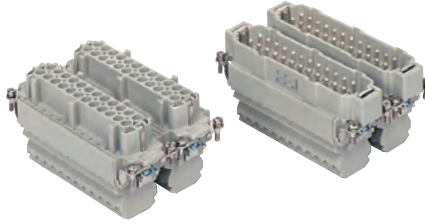
enclosures:
size "104.62"

page:

C-TYPE IP65 or IP66/IP69
W-TYPE for aggressive environments
E-Xtreme® corrosion proof

430
526
547

inserts,
connection with dual spring
terminal per pole



can be mated with CNE, CCE, CTSE, CSH inserts

description	part No.	part No.
spring terminals with actuator button		
female inserts with female contacts, No. (1-24) and (25-48)	CSSF 24	CSSF 24 N
male inserts with male contacts, No. (1-24) and (25-48)	CSSM 24	CSSM 24 N

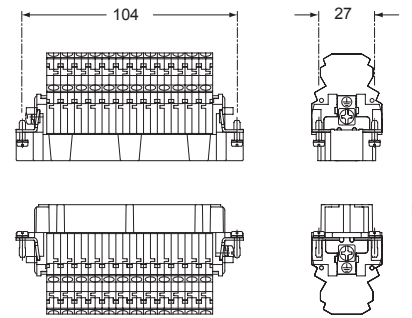
The CSS series inserts can be inserted in flush mounted enclosures or in fixed / portable high enclosures.

- characteristics according to EN 61984:

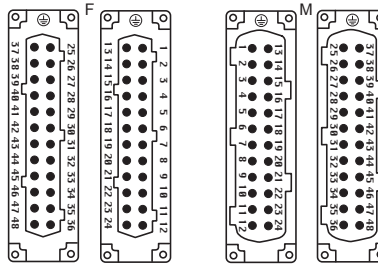
16A 500V 6kV 3
16A 400/690V 6kV 2

- certified

- rated voltage according to UL/CSA: 600V
- insulation resistance: $\geq 10 \text{ G}\Omega$
- ambient temperature limit: $-40 \text{ }^\circ\text{C} \dots +125 \text{ }^\circ\text{C}$
- made of self-extinguishing thermoplastic resin UL 94V-0
- mechanical life: ≥ 500 cycles
- contact resistance: $\leq 3 \text{ m}\Omega$
- for max. current load see the connector inserts derating diagram below; for more information see page 28

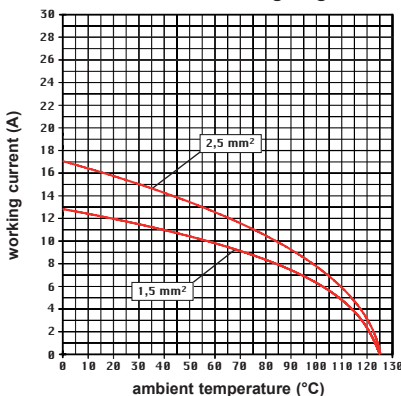


contacts side (front view)

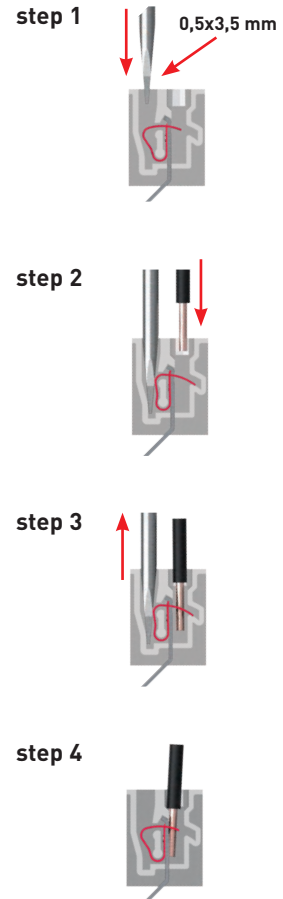


- inserts with plate for section conductors: 0,14 - 2,5 mm² - AWG 26 - 14
- conductors stripping length: 9...11 mm

CSS 48 poles connector inserts
Maximum current load derating diagram



Connection technology



Inserts with incorporated terminal block for multipole connectors (10A max versions)

CT series multipole connectors (with incorporated 45° terminal block) are recommended for greater cost-saving and safety for use on machines and command and control panels.

For control panel mounting, bulkhead housings must be used.

CT series inserts (10A max versions) are supplied in the plug or socket versions and must be mounted with insertion from the rear of the enclosure (Figures 1 and 2), as the space occupied by the terminal block does not allow for the passage of the insert and insertion from the front of the enclosure.

As an alternative to the traditional terminal blocks, the inserts can be mounted inside the control panels on DIN EN 60715 rails (Figure 5) using suitable accessories providing the added advantage of easy sectioning.

The special structure of CT inserts provides all the conductor connections on the same side, achieving easier wiring and a complete view of the work area.

The 45° terminal block has also slots for housing the identification wire markers of each contact.

Wire markers of different manufacturers may be used such as: Cabur, Grafoplast, Modernotecnica, Phoenix Contact, Siemens, Wago, Weidmüller.

CT series is available in the versions "left-hand" and "right-hand" for mounting on the left (Figure 3) or on the right (Figure 4) of the control panel walls.

This characteristic is determined by the position of contact "1" and the protective earth terminal in the upper part of the insert terminal block for both left and right mounting.

The installation of inserts on DIN rails (Figure 5) inside the control panels is usually made to ease the wiring in sectionable parts.

In this case the degree of protection for coupled connectors is IP20 (in accordance with EN 60529).

This type of mounting requires supports (CT APE) suitable for mounting on DIN EN 60715 rail. to be provided to the inserts.

In addition, CRBF (female) and CRBM (male) coupling screws instead of normal screws are recommended for fixing the inserts to the enclosures (Figure 5) in order to guarantee a stable and safe coupling between the CT and CTS inserts installed on the DIN rails and corresponding mating CD inserts.

Figures 1 and 2 (rear mounting)

The insert is inserted into the bulkhead housing with pre-wired conductors connected at the opposite end

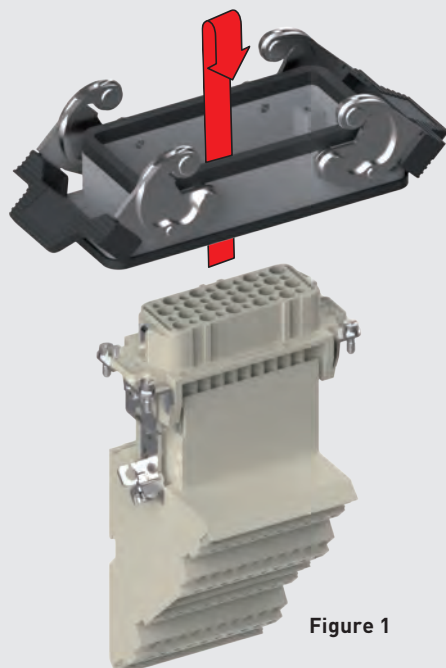


Figure 1

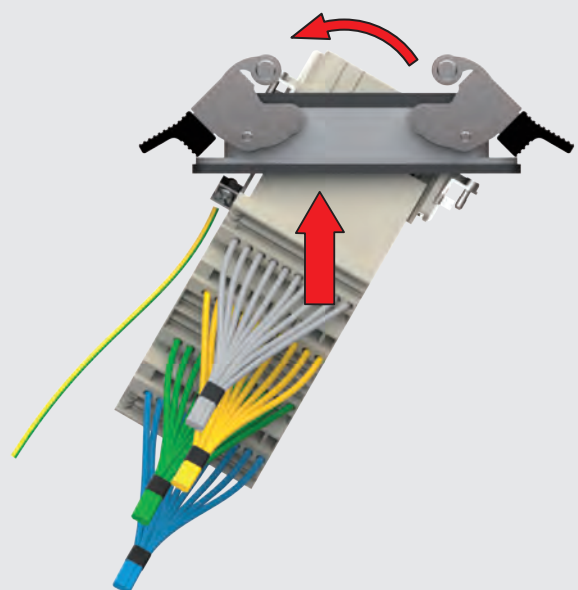
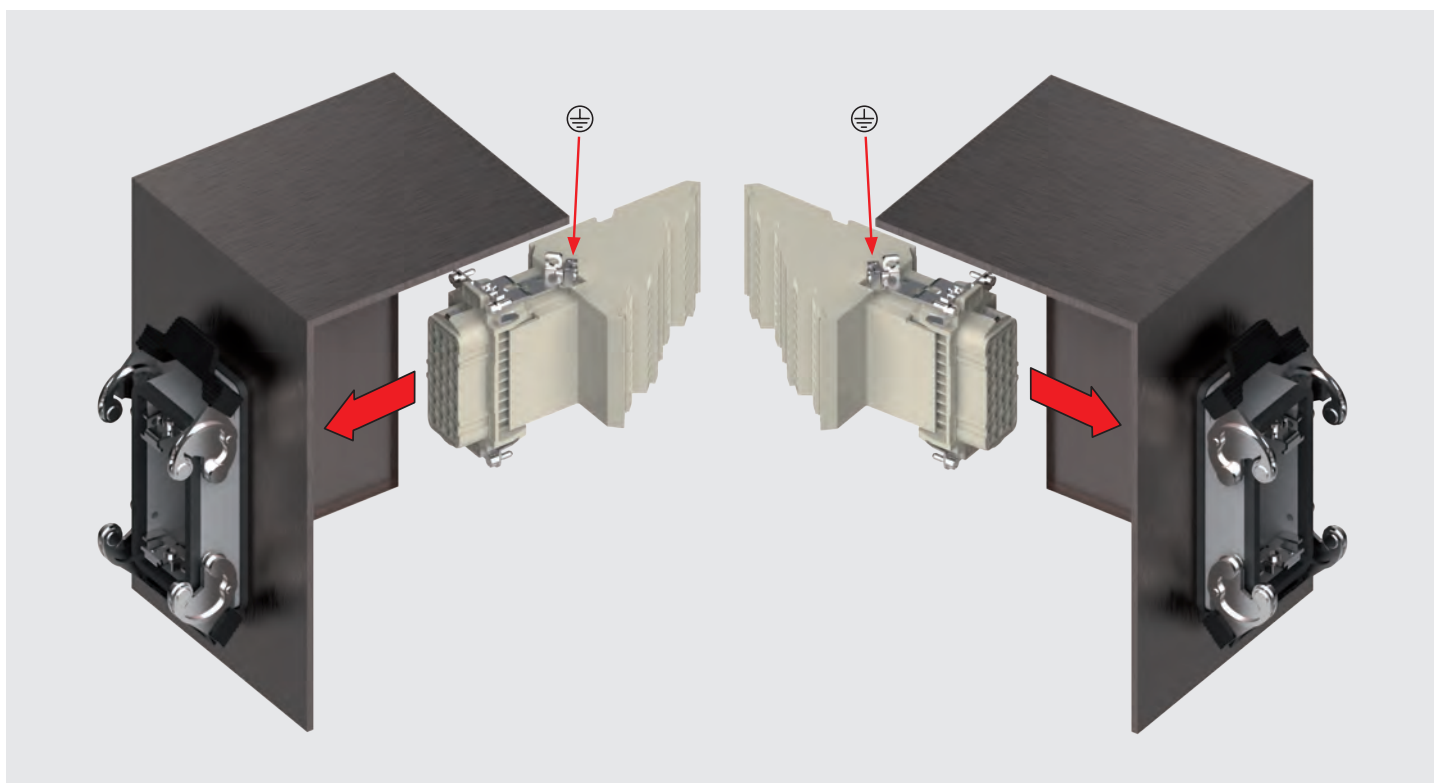


Figure 2

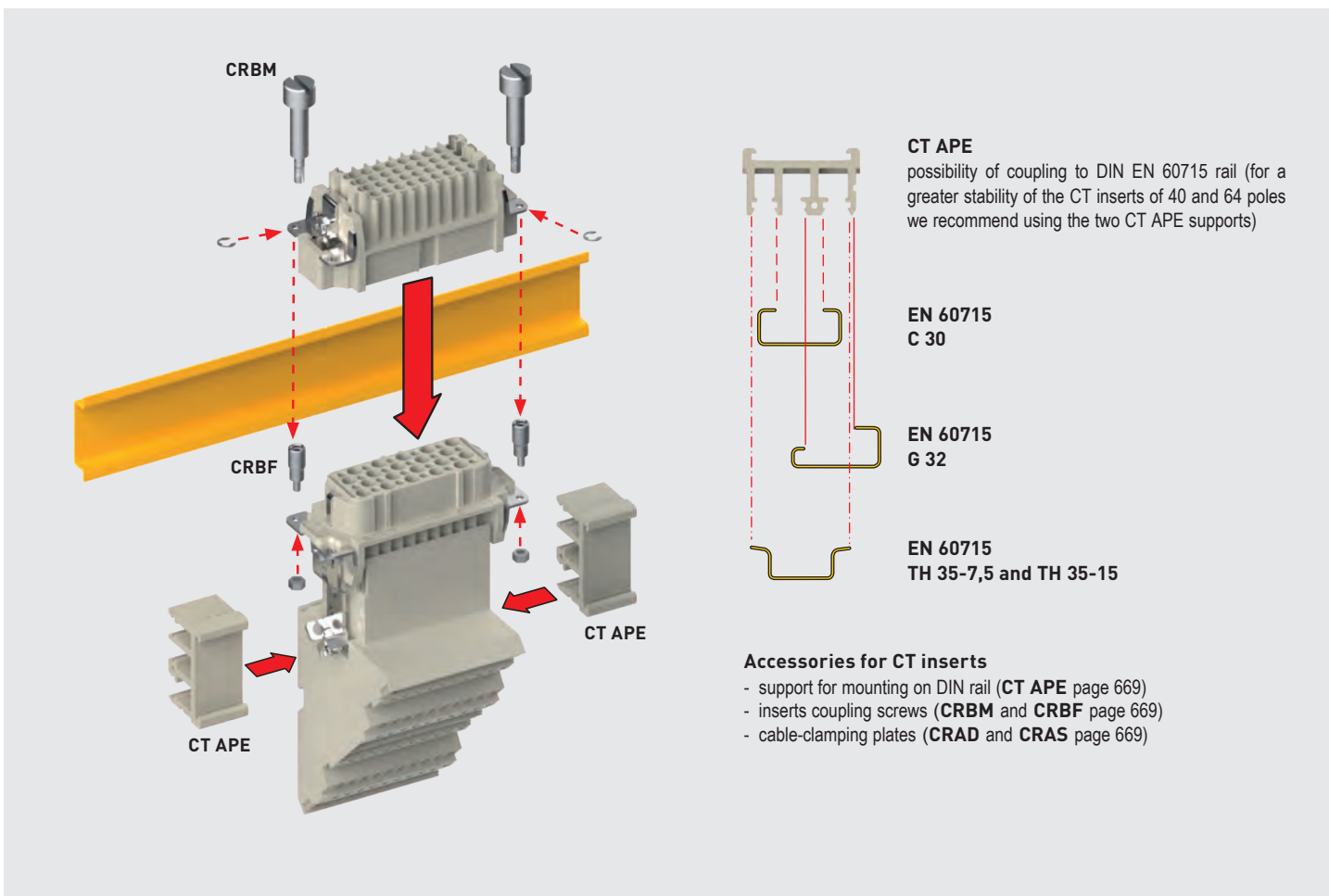
Figure 3 (left mounting)

Figure 4 (right mounting)



CT - CTS

Figure 5 (mounting on DIN rail)



CT - CTS 40 poles + ⊕ 10A - 250V

enclosures *):
size "77.27"

page:

C-TYPE IP65 or IP66/IP69	402
C7 IP67, two levers	439 - 440
V-TYPE IP65 or IP66/IP69, single lever	454 - 455
W-TYPE for aggressive environments	523
E-Xtreme® corrosion proof	534, 544
EMC	580
Central lever	609
LS-TYPE	622

*) only bulkhead mounted housings

- can be mated with CD inserts
- rear-mounted inserts

terminal block inserts screw terminal connection



Q SILVER PLATED CONTACTS

terminal block inserts spring terminal connection



Q SILVER PLATED CONTACTS

description	part No.	part No.	part No.	part No.
mounting side (see page 155)	left	right	left	right
female inserts with female contacts ¹⁾	CTF 40 L	CTF 40 R	CTSF 40 L	CTSF 40 R
male inserts with male contacts ¹⁾	CTM 40 L	CTM 40 R	CTSM 40 L	CTSM 40 R
mounting side (see page 155)				
female inserts with female contacts				
male inserts with male contacts				

1) for non-prepared conductors

- characteristics according to EN 61984:

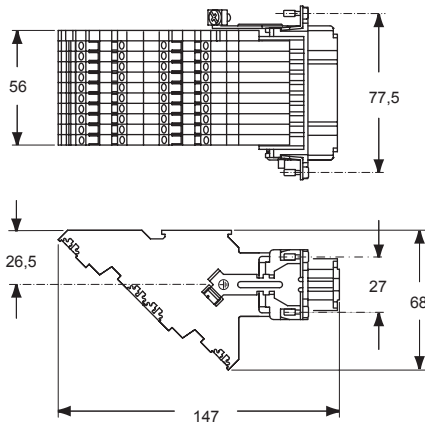
10A 250V 4kV 3
10A 230/400V 4kV 2

- certified (CT)

- certified (CTS)

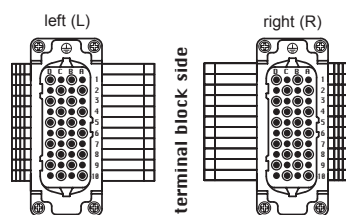
- rated voltage according to UL/CSA: 600V
- insulation resistance: ≥ 10 GΩ
- ambient temperature limit: -40 °C ... +125 °C
- made of self-extinguishing thermoplastic resin UL 94V-0
- mechanical life: ≥ 500 cycles
- contact resistance: ≤ 4 mΩ
- for max. current load see the connector inserts derating diagram below; for more information see page 28

female inserts (CTF and CTSF)

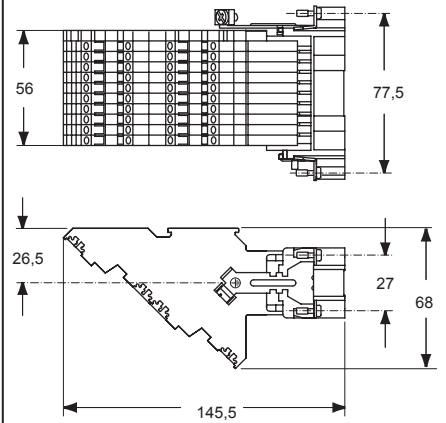


contacts side (front view)

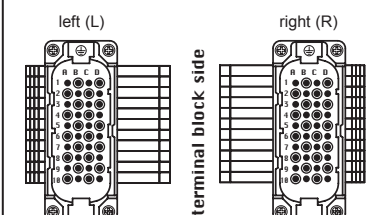
female inserts (CTF and CTSF)



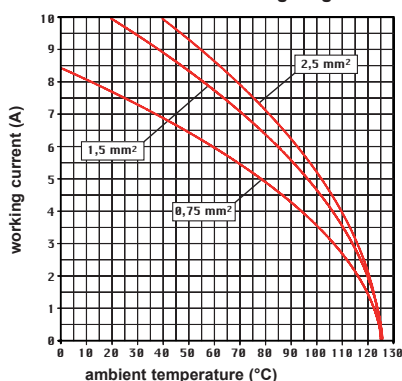
male inserts (CTM and CTSM)



male inserts (CTM and CTSM)



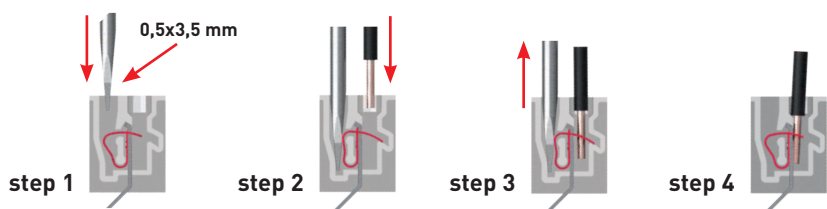
CT and CTS 40 poles connector inserts
Maximum current load derating diagram



- CT inserts with plate, for section conductors: 0,75 - 2,5 mm² - AWG 18 - 14
- conductors stripping length: 12 mm
- terminal screw torque: 0,4 Nm (3,54 lb.in), for more information see page 20 and 21

- CTS spring inserts for section conductors: effective sections for non-prepared conductors 0,14 - 2,5 mm² - AWG 26 - 14
- effective sections for prepared conductors 0,14 - 1 mm² - AWG 26 - 18
- conductors stripping length: 9...11 mm

Connection technology with spring terminal



CT - CTS 64 poles + ⊕ 10A - 250V

enclosures *):
size "104.27"

page:

C-TYPE IP65 or IP66/IP69	412
C7 IP67, two levers	441 - 442
V-TYPE IP65 or IP66/IP69, single lever	459 - 460
W-TYPE for aggressive environments	524
E-Xtreme® corrosion proof	536, 545
EMC	581
Central lever	612
LS-TYPE	624

*) only bulkhead mounted housings

- can be mated with CD inserts
- rear-mounted inserts

terminal block inserts screw terminal connection



Q SILVER PLATED CONTACTS

terminal block inserts spring terminal connection



Q SILVER PLATED CONTACTS

description	part No.	part No.	part No.	part No.
mounting side (see page 155)	left	right	left	right
female inserts with female contacts ¹⁾	CTF 64 L	CTF 64 R	CTSF 64 L	CTSF 64 R
male inserts with male contacts ¹⁾	CTM 64 L	CTM 64 R	CTSM 64 L	CTSM 64 R
mounting side (see page 155)				
female inserts with female contacts				
male inserts with male contacts				

¹⁾ for non-prepared conductors

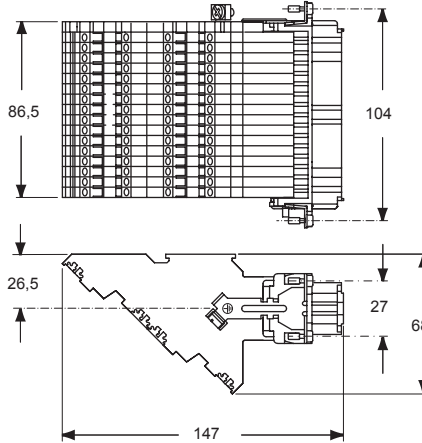
- characteristics according to EN 61984:

10A 250V 4kV 3
10A 230/400V 4kV 2

- certified (CT)
- certified (CTS)

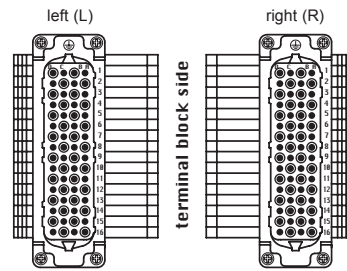
- rated voltage according to UL/CSA: 600V
- insulation resistance: $\geq 10 \text{ G}\Omega$
- ambient temperature limit: $-40 \text{ }^\circ\text{C} \dots +125 \text{ }^\circ\text{C}$
- made of self-extinguishing thermoplastic resin UL 94V-0
- mechanical life: ≥ 500 cycles
- contact resistance: $\leq 4 \text{ m}\Omega$
- for max. current load see the connector inserts derating diagram below; for more information see page 28

female inserts (CTF and CTSF)

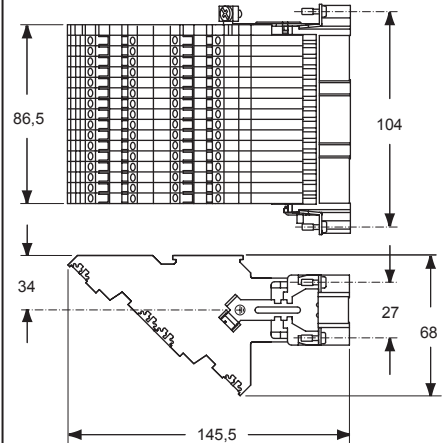


contacts side (front view)

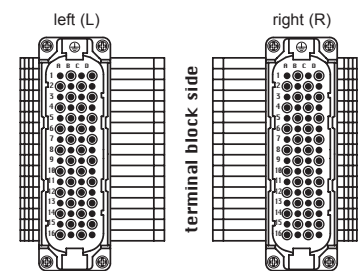
female inserts (CTF and CTSF)



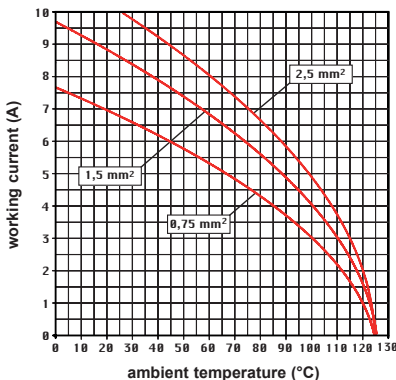
male inserts (CTM and CTSM)



male inserts (CTM and CTSM)



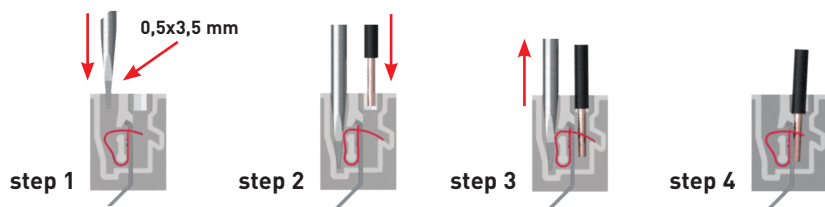
CT and CTS 64 poles connector inserts
Maximum current load derating diagram



- CT inserts with plate, for section conductors: 0,75 - 2,5 mm² - AWG 18 - 14
- conductors stripping length: 12 mm
- terminal screw torque: 0,4 Nm (3,54 lb.in), for more information see page 20 and 21

- CTS spring inserts for section conductors: effective sections for non-prepared conductors 0,14 - 2,5 mm² - AWG 26 - 14
- effective sections for prepared conductors 0,14 - 1 mm² - AWG 26 - 18
- conductors stripping length: 9...11 mm

Connection technology with spring terminal



Inserts with incorporated terminal block for multipole connectors (16A max versions)

45° CT - CTSE series multipole connectors (with incorporated terminal block) are recommended for greater cost-saving and safety for use on machines and command and control panels.

The CT - CTSE series inserts (16A max versions) are supplied in the plug or socket versions and may be mounted with insertion from the front of the enclosure (Figure 1 for all the polarities of the inserts) or with insertion from the rear of the enclosure (Figure 2, only for 16 and 24-pole inserts).

As an alternative to the traditional terminal blocks, the inserts can be mounted inside the control panels on DIN EN rails (Figure 5) using suitable accessories providing the added advantage of easy sectioning.

The special structure of the CT - CTSE inserts has all the conductor connections on the same side providing for easier wiring and a complete view of the work area.

The terminal block has also slots for housing the identification wire markers of each contact.

Wire markers of different manufacturers may be used such as: Cabur, Grafoplast, Modernotecnica, Phoenix Contact, Siemens, Wago, Weidmüller.

The CT - CTSE series is available in the versions "left" and "right" for mounting on the left (Figure 3) or on the right (Figure 4) of the control panel walls.

This characteristic is determined by the position of contact "1" and the ground terminal in the upper part of the insert terminal block for both left and right mounting.

The installation of inserts on DIN rails (Figure 5) inside the control panels is usually made to facilitate the wiring into sectionable parts.

In this case the degree of protection for coupled connectors is IP20 (in accordance with EN 60529).

This type of mounting requires supports (CT APE) suitable for mounting on DIN EN 60715 rails.

Furthermore, to ensure a stable and secure mating between the CT and CTSE inserts installed on DIN rails and counterparts CNE, CCE, CSH, CSS mating screws CRBF (female) and CRBM (male) are recommended, to replace the ordinary fastening screws to the enclosures (Figure 5).

Figure 1 (front mounting)

The insert is inserted into the bulkhead housing without wired conductors or with pre-wired conductors that are not connected at the opposite end.

Mounting for inserts of 06, 10, 16 and 24 poles

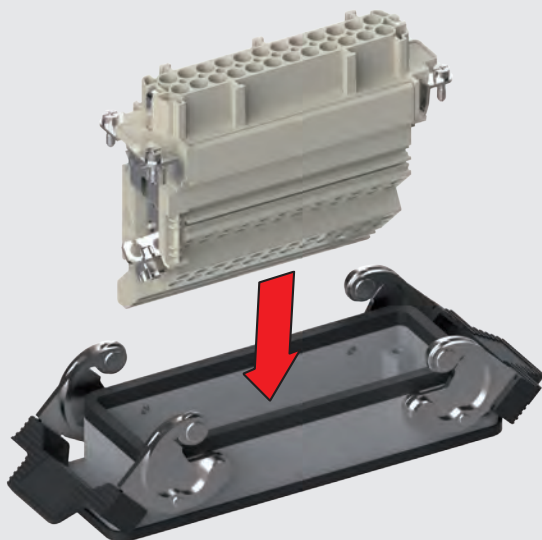
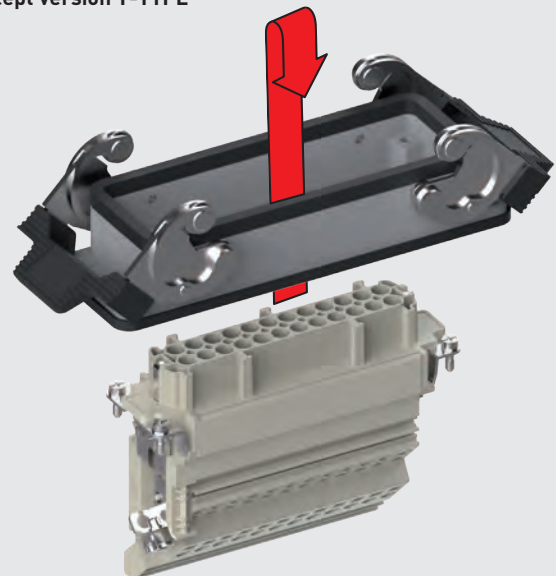


Figure 2 (rear mounting)

The insert is inserted into the bulkhead housing with pre-wired conductors connected at the opposite end.

Mounting for inserts of 16 and 24 poles

Except version T-TYPE



CT 6 poles + ⊕ 16A - 400V

CTSE 6 poles + ⊕ 16A - 500V

enclosures *):
size "44.27"

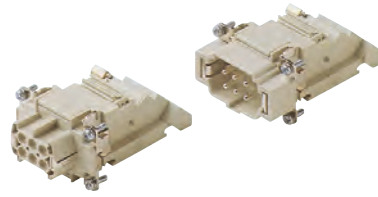
page:

C-TYPE IP65 or IP66/IP69	387
C7 IP67, single lever	436 - 437
V-TYPE IP65 or IP66/IP69, single lever	444 - 445
BIG hoods	466 - 467
T-TYPE IP65 insulating	480 - 481
T-TYPE / W IP66/IP69 insulating	489
HYGIENIC T-TYPE / H IP66/IP69	501
HYGIENIC T-TYPE / C IP66/IP69, -50 °C	506
W-TYPE for aggressive environments	521
E-Xtreme® corrosion proof	530, 542
EMC	578
Central lever	603
LS-TYPE	618

*) only bulkhead mounted housings and BIG hoods

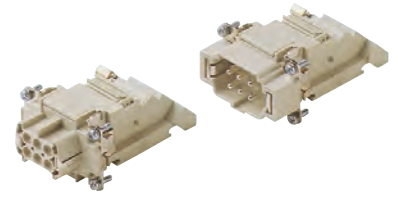
- can be mated with CNE, CCE, CSS, CSH inserts
- inserts may be fitted from front of enclosure

**terminal block inserts
screw terminal connection**



Q SILVER PLATED CONTACTS

**terminal block inserts
spring terminal connection**



Q SILVER PLATED CONTACTS

description	part No.	part No.	part No.	part No.
mounting side (see page 159)	left	right	left	right
female inserts with female contacts ¹⁾	CTF 06 L	CTF 06 R	CTSEF 06 L	CTSEF 06 R
male inserts with male contacts ¹⁾	CTM 06 L	CTM 06 R	CTSEM 06 L	CTSEM 06 R
mounting side (see page 159)				
female inserts with female contacts				
male inserts with male contacts				

1) for non-prepared conductors

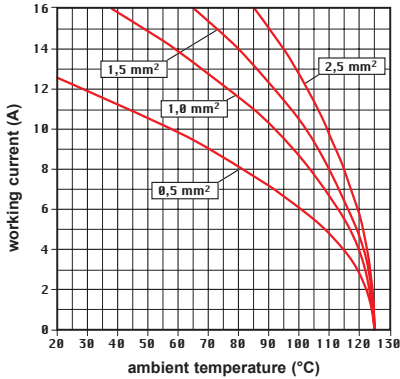
- characteristics according to EN 61984:
- 16A 230/400V 4kV 3 (CT)**
- 16A 400V 4kV 2 (CT)**
- 16A 500V 6kV 3 (CTSE)**
- 16A 400/690V 6kV 2 (CTSE)**

- certified (CT)

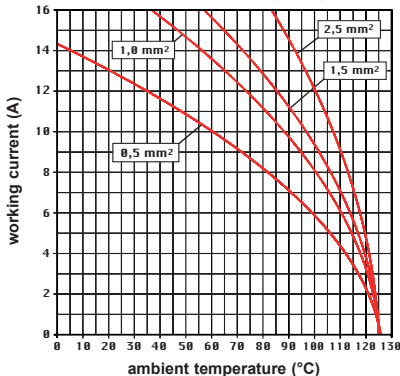
- certified (CTSE)

- rated voltage according to UL/CSA: 600V
- insulation resistance: ≥ 10 GΩ
- ambient temperature limit: -40 °C ... +125 °C
- made of self-extinguishing thermoplastic resin UL 94V-0
- mechanical life: ≥ 500 cycles
- contact resistance: ≤ 4 mΩ
- for max. current load see the connector inserts derating diagrams below; for more information see page 28

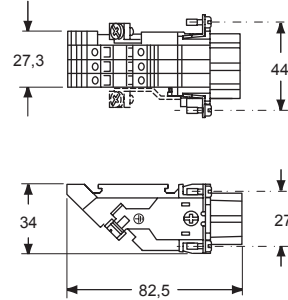
**CT 06 poles connector inserts
Maximum current load derating diagram**



**CTSE 06 poles connector inserts
Maximum current load derating diagram**

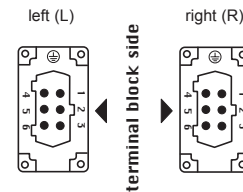


female inserts (CTF and CTSEF)



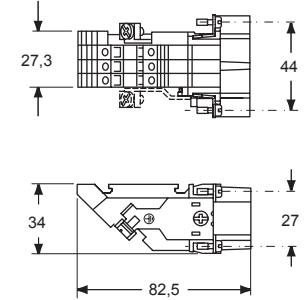
contacts side (front view)

female inserts (CTF and CTSEF)

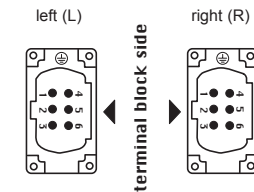


- CT inserts with plate, for section conductors: 0,75 - 2,5 mm² - AWG 18 - 14
- conductors stripping length: 12 mm
- terminal screw torque: 0,4 Nm (3,54 lb.in), for more information see page 20 and 21

male inserts (CTM and CTSEM)

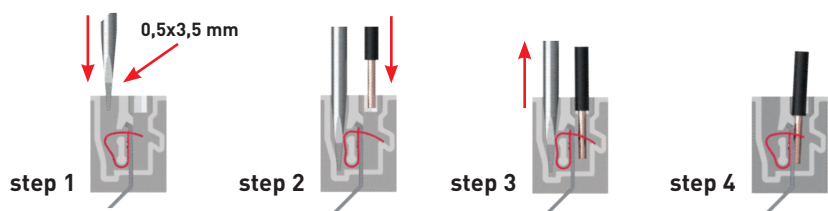


male inserts (CTM and CTSEM)



- CTSE spring inserts for section conductors: 0,14 - 2,5 mm² - AWG 26 - 14
- conductors stripping length: 9...11 mm

Connection technology with spring terminal



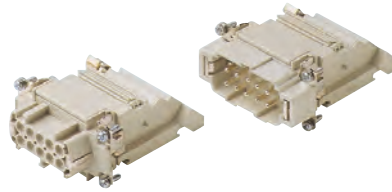
CT 10 poles + ⊕ 16A - 400V CTSE 10 poles + ⊕ 16A - 500V

enclosures *): size "57.27"	page:
C-TYPE IP65 or IP66/IP69	393
C7 IP67, two levers	438
V-TYPE IP65 or IP66/IP69, single lever	448 - 449
BIG hoods	468 - 469
T-TYPE IP65 insulating	482 - 483
T-TYPE / W IP66/IP69 insulating	490
HYGIENIC T-TYPE / H IP66/IP69	502
HYGIENIC T-TYPE / C IP66/IP69, -50 °C	507
W-TYPE for aggressive environments	522
E-Xtreme® corrosion proof	532, 543
EMC	579
Central lever	606
LS-TYPE	620

*) only bulkhead mounted housings and BIG hoods

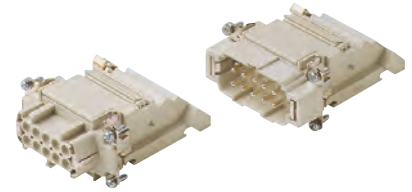
- can be mated with CNE, CCE, CSS, CSH inserts
- inserts may be fitted from front of enclosure

**terminal block inserts
screw terminal connection**



Q SILVER PLATED CONTACTS

**terminal block inserts
spring terminal connection**



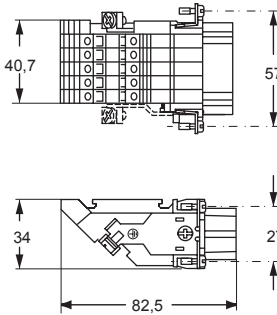
Q SILVER PLATED CONTACTS

description	part No.	part No.	part No.	part No.
mounting side (see page 159)	left	right	left	right
female inserts with female contacts ¹⁾	CTF 10 L	CTF 10 R	CTSEF 10 L	CTSEF 10 R
male inserts with male contacts ¹⁾	CTM 10 L	CTM 10 R	CTSEM 10 L	CTSEM 10 R
mounting side (see page 159)				
female inserts with female contacts				
male inserts with male contacts				

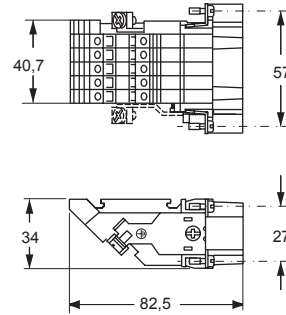
1) for non-prepared conductors

- characteristics according to EN 61984:
16A 230/400V 4kV 3 (CT)
16A 400V 4kV 2 (CT)
16A 500V 6kV 3 (CTSE)
16A 400/690V 6kV 2 (CTSE)
- certified (CT)
- certified (CTSE)
- rated voltage according to UL/CSA: 600V
- insulation resistance: ≥ 10 GΩ
- ambient temperature limit: -40 °C ... +125 °C
- made of self-extinguishing thermoplastic resin UL 94V-0
- mechanical life: ≥ 500 cycles
- contact resistance: ≤ 4 mΩ
- for max. current load see the connector inserts derating diagrams below; for more information see page 28

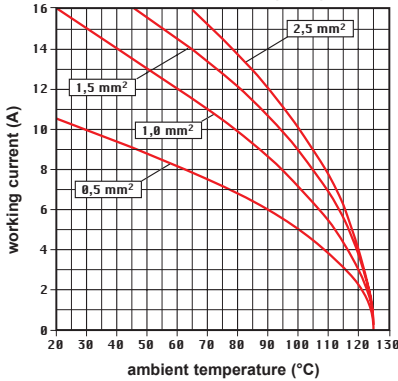
female inserts (CTF and CTSEF)



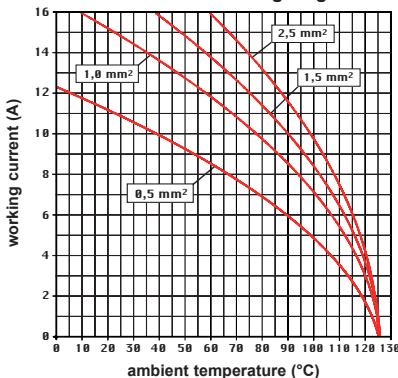
male inserts (CTM and CTSEM)



**CT 10 poles connector inserts
Maximum current load derating diagram**

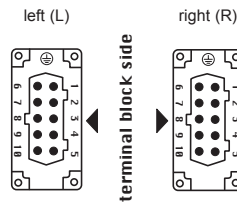


**CTSE 10 poles connector inserts
Maximum current load derating diagram**

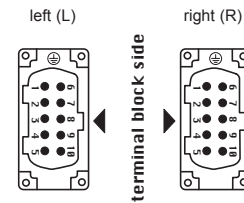


contacts side (front view)

female inserts (CTF and CTSEF)



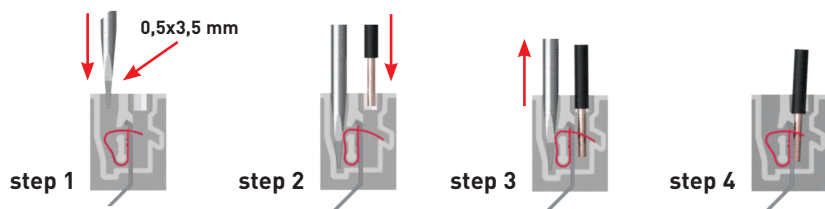
male inserts (CTM and CTSEM)



- CT inserts with plate, for section conductors:
0,75 - 2,5 mm² - AWG 18 - 14
- conductors stripping length: 12 mm
- terminal screw torque: 0,4 Nm (3,54 lb.in),
for more information see page 20 and 21

- CTSE spring inserts for section conductors:
0,14 - 2,5 mm² - AWG 26 - 14
- conductors stripping length: 9...11 mm

Connection technology with spring terminal



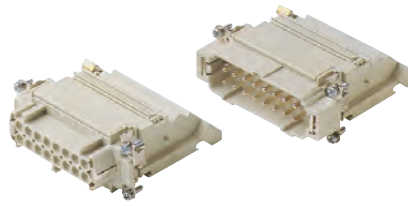
CT 16 poles + ⊕ 16A - 400V CTSE 16 poles + ⊕ 16A - 500V

enclosures *): size "77.27"	page:
C-TYPE IP65 or IP66/IP69	402
C7 IP67, two levers	439 - 440
V-TYPE IP65 or IP66/IP69, single lever	454 - 455
BIG hoods	470 - 471
T-TYPE IP65 insulating	484 - 485
T-TYPE / W IP66/IP69 insulating	491
HYGIENIC T-TYPE / H IP66/IP69	503
HYGIENIC T-TYPE / C IP66/IP69, -50 °C	508
W-TYPE for aggressive environments	523
E-Xtreme® corrosion proof	534, 544
EMC	580
Central lever	609
LS-TYPE	622

*) only bulkhead mounted housings and BIG hoods

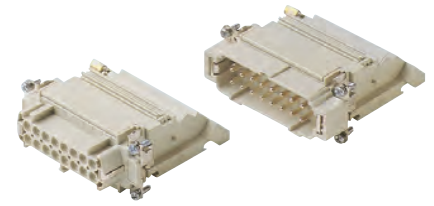
- can be mated with CNE, CCE, CSS, CSH inserts
- inserts may be fitted from front of enclosure

**terminal block inserts
screw terminal connection**



Q SILVER PLATED CONTACTS

**terminal block inserts
spring terminal connection**



Q SILVER PLATED CONTACTS

description	part No.	part No.	part No.	part No.
mounting side (see page 159)	left	right	left	right
female inserts with female contacts ¹⁾	CTF 16 L	CTF 16 R	CTSEF 16 L	CTSEF 16 R
male inserts with male contacts ¹⁾	CTM 16 L	CTM 16 R	CTSEM 16 L	CTSEM 16 R
mounting side (see page 159)				
female inserts with female contacts				
male inserts with male contacts				

1) for non-prepared conductors

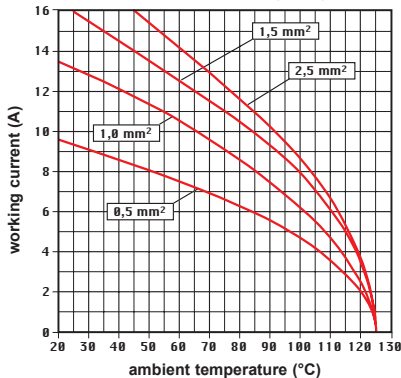
- characteristics according to EN 61984:
- 16A 230/400V 4kV 3 (CT)**
- 16A 400V 4kV 2 (CT)**
- 16A 500V 6kV 3 (CTSE)**
- 16A 400/690V 6kV 2 (CTSE)**

- certified (CT)

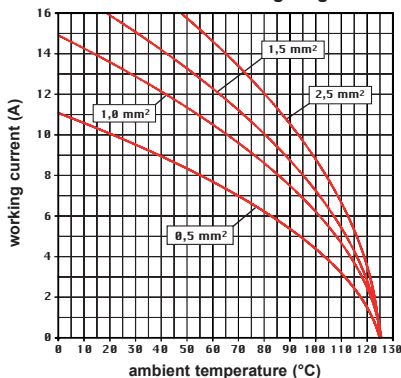
- certified (CTSE)

- rated voltage according to UL/CSA: 600V
- insulation resistance: ≥ 10 GΩ
- ambient temperature limit: -40 °C ... +125 °C
- made of self-extinguishing thermoplastic resin UL 94V-0
- mechanical life: ≥ 500 cycles
- contact resistance: ≤ 4 mΩ
- for max. current load see the connector inserts derating diagrams below; for more information see page 28

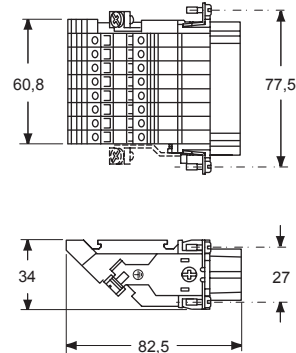
**CT 16 poles connector inserts
Maximum current load derating diagram**



**CTSE 16 poles connector inserts
Maximum current load derating diagram**

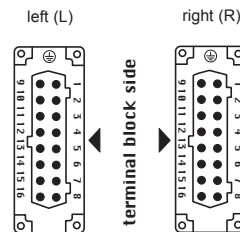


female inserts (CTF and CTSEF)



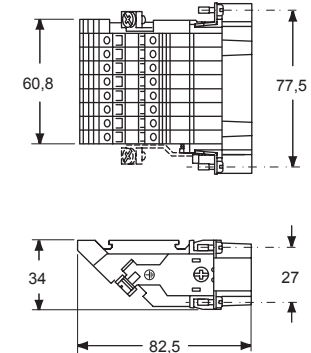
contacts side (front view)

female inserts (CTF and CTSEF)

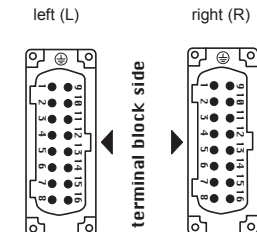


- CT inserts with plate, for section conductors: 0,75 - 2,5 mm² - AWG 18 - 14
- conductors stripping length: 12 mm
- terminal screw torque: 0,4 Nm (3,54 lb.in), for more information see page 20 and 21

male inserts (CTM and CTSEM)

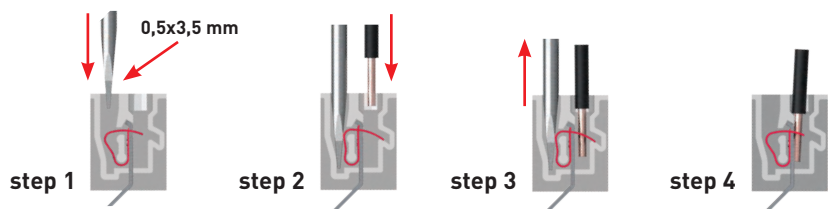


male inserts (CTM and CTSEM)



- CTSE spring inserts for section conductors: 0,14 - 2,5 mm² - AWG 26 - 14
- conductors stripping length: 9...11 mm

Connection technology with spring terminal



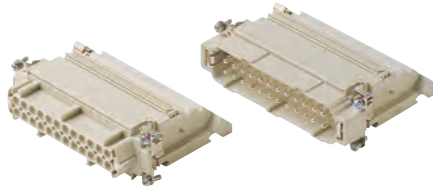
CT 24 poles + ⊕ 16A - 400V CTSE 24 poles + ⊕ 16A - 500V

enclosures *): size "104.27"	page:
C-TYPE IP65 or IP66/IP69	412
C7 IP67, two levers	441 - 442
V-TYPE IP65 or IP66/IP69, single lever	459 - 460
BIG hoods	472 - 473
T-TYPE IP65 insulating	486 - 487
T-TYPE / W IP66/IP69 insulating	492
HYGIENIC T-TYPE / H IP66/IP69	504
HYGIENIC T-TYPE / C IP66/IP69, -50 °C	509
W-TYPE for aggressive environments	524
E-Xtreme® corrosion proof	536, 545
EMC	581
Central lever	612
LS-TYPE	624

*) only bulkhead mounted housings and BIG hoods

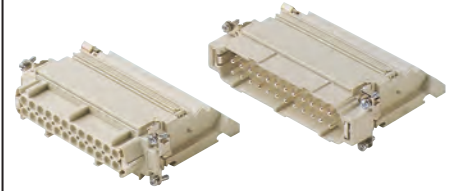
- can be mated with CNE, CCE, CSS, CSH inserts
- inserts may be fitted from front of enclosure

**terminal block inserts
screw terminal connection**



Q SILVER PLATED CONTACTS

**terminal block inserts
spring terminal connection**



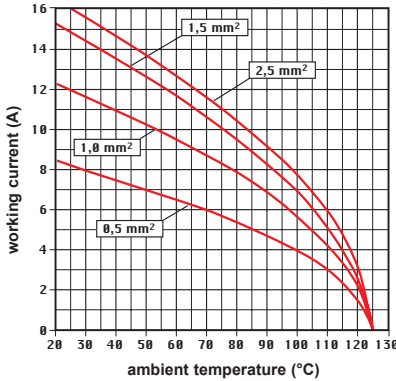
Q SILVER PLATED CONTACTS

description	part No.	part No.	part No.	part No.
mounting side (see page 159)	left	right	left	right
female inserts with female contacts ¹⁾	CTF 24 L	CTF 24 R	CTSEF 24 L	CTSEF 24 R
male inserts with male contacts ¹⁾	CTM 24 L	CTM 24 R	CTSEM 24 L	CTSEM 24 R
mounting side (see page 159)				
female inserts with female contacts				
male inserts with male contacts				

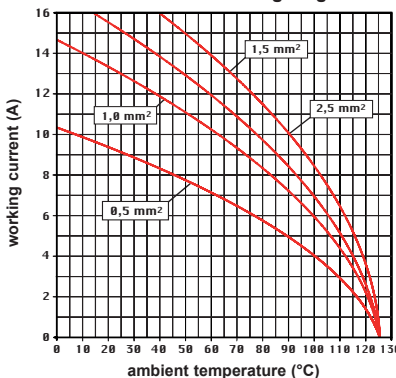
1) for non-prepared conductors

- characteristics according to EN 61984:
16A 230/400V 4kV 3 (CT)
16A 400V 4kV 2 (CT)
16A 500V 6kV 3 (CTSE)
16A 400/690V 6kV 2 (CTSE)
- certified (CT)
- certified (CTSE)
- rated voltage according to UL/CSA: 600V
- insulation resistance: ≥ 10 GΩ
- ambient temperature limit: -40 °C ... +125 °C
- made of self-extinguishing thermoplastic resin UL 94V-0
- mechanical life: ≥ 500 cycles
- contact resistance: ≤ 4 mΩ
- for max. current load see the connector inserts derating diagrams below; for more information see page 28

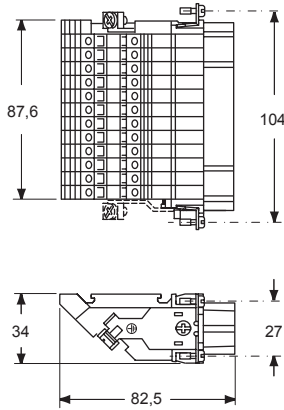
**CT 24 poles connector inserts
Maximum current load derating diagram**



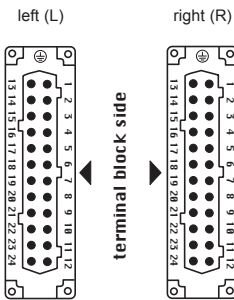
**CTSE 24 poles connector inserts
Maximum current load derating diagram**



female inserts (CTF and CTSEF)

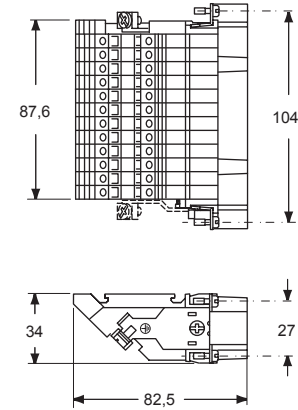


**contacts side (front view)
female inserts (CTF and CTSEF)**

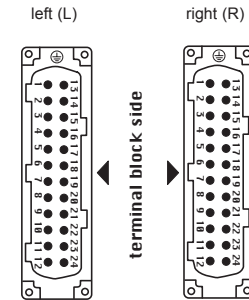


- CT inserts with plate, for section conductors: 0,75 - 2,5 mm² - AWG 18 - 14
- conductors stripping length: 12 mm
- terminal screw torque: 0,4 Nm (3,54 lb.in), for more information see page 20 and 21

male inserts (CTM and CTSEM)

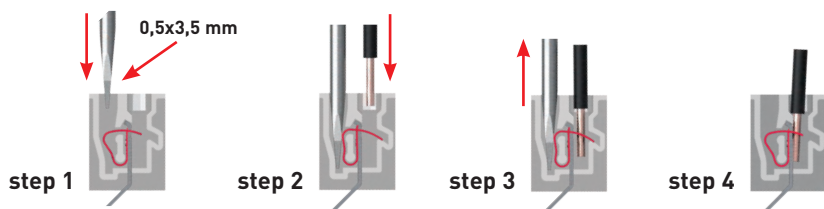


male inserts (CTM and CTSEM)



- CTSE spring inserts for section conductors: 0,14 - 2,5 mm² - AWG 26 - 14
- conductors stripping length: 9...11 mm

Connection technology with spring terminal



CTSE 32 poles + ⊕ 16A - 500V

enclosures *):
size "77.62"

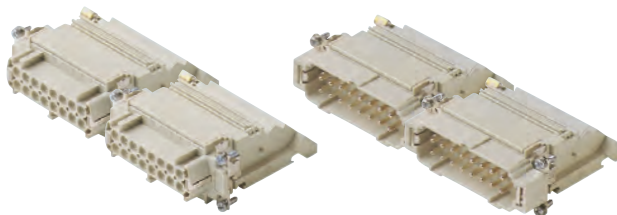
page:

C-TYPE IP65 or IP66/IP69
W-TYPE for aggressive environments
E-Xtreme® corrosion proof

424
525
546

*) only bulkhead mounted housings

terminal block inserts spring terminal connection



Q SILVER PLATED CONTACTS

description	part No.	part No.	part No.	part No.
mounting side (see page 159)	left	right	left	right
female inserts with female contacts, No. (1-16) and (17-32) ¹⁾	CTSEF 16 LN	CTSEF 16 R	CTSEF 16 L	CTSEF 16 RN
male inserts with male contacts, No. (1-16) and (17-32) ¹⁾	CTSEM 16 LN	CTSEM 16 R	CTSEM 16 L	CTSEM 16 RN

1) for non-prepared conductors

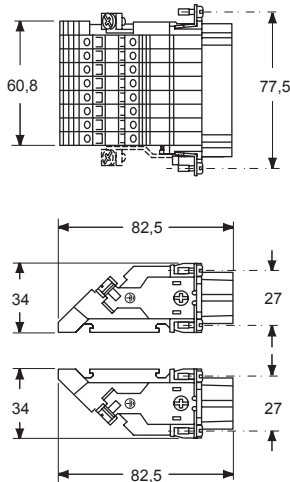
- characteristics according to EN 61984:

16A 500V 6kV 3
16A 400/690V 6kV 2

- certified

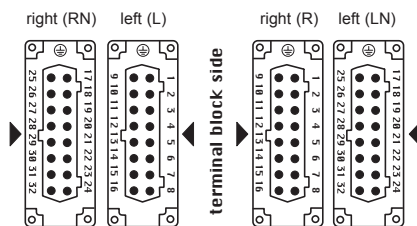
- rated voltage according to UL/CSA: 600V
- insulation resistance: $\geq 10 \text{ G}\Omega$
- ambient temperature limit: $-40 \text{ }^\circ\text{C} \dots +125 \text{ }^\circ\text{C}$
- made of self-extinguishing thermoplastic resin UL 94V-0
- mechanical life: ≥ 500 cycles
- contact resistance: $\leq 4 \text{ m}\Omega$
- for max. current load see the connector inserts derating diagrams below; for more information see page 28

female inserts (CTSEF)

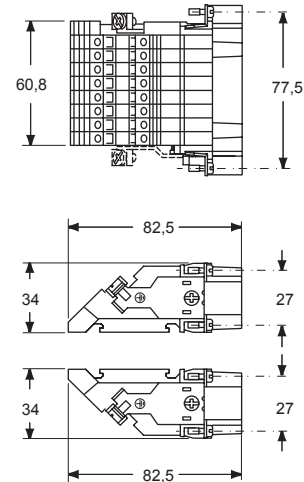


contacts side (front view)

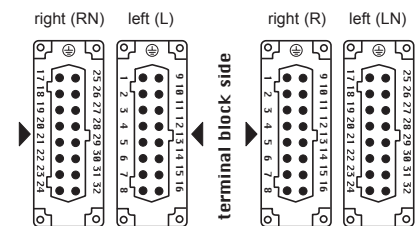
female inserts (CTSEF)



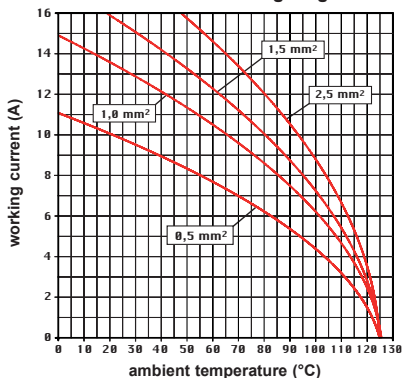
male inserts (CTSEM)



male inserts (CTSEM)

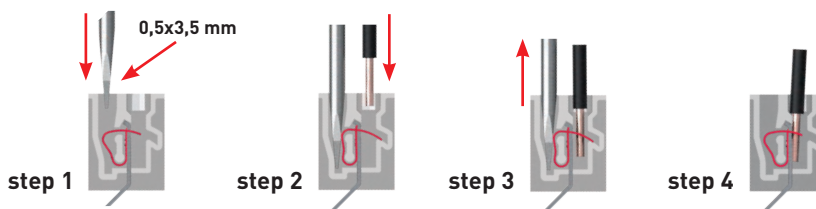


CTSE 32 poles connector inserts
Maximum current load derating diagram



- CTSE spring inserts for section conductors: 0,14 - 2,5 mm² - AWG 26 - 14
- conductors stripping length: 9...11 mm

Connection technology with spring terminal



CTSE 48 poles + ⊕ 16A - 500V

enclosures *):
size "104.62"

page:

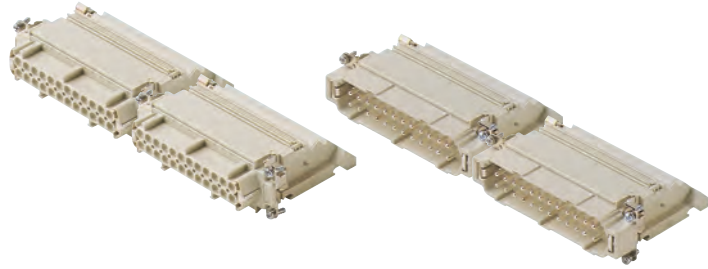
C-TYPE IP65 or IP66/IP69
W-TYPE for aggressive environments
E-Xtreme® corrosion proof

430
526
547

*) only bulkhead mounted housings

- CT screw version: on request
- can be mated with CNE, CCE, CSS, CSH inserts
- inserts may be fitted from front of enclosure

terminal block inserts spring terminal connection



Q SILVER PLATED CONTACTS

description	part No.	part No.	part No.	part No.
mounting side (see page 159)	left	right	left	right
female inserts with female contacts, No. (1-24) and (25-48) ¹⁾	CTSEF 24 LN	CTSEF 24 R	CTSEF 24 L	CTSEF 24 RN
male inserts with male contacts, No. (1-24) and (25-48) ¹⁾	CTSEM 24 LN	CTSEM 24 R	CTSEM 24 L	CTSEM 24 RN

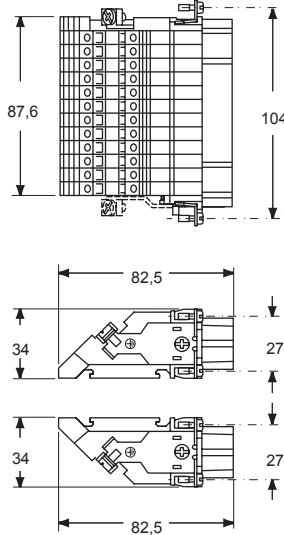
1) for non-prepared conductors

- characteristics according to EN 61984:
16A 500V 6kV 3
16A 400/690V 6kV 2

- certified

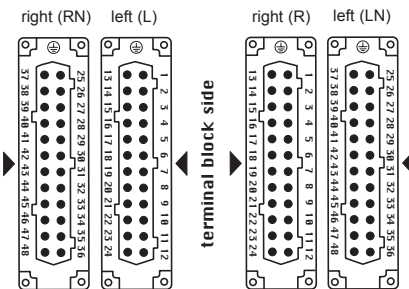
- rated voltage according to UL/CSA: 600V
- insulation resistance: $\geq 10 \text{ G}\Omega$
- ambient temperature limit: $-40 \text{ }^\circ\text{C} \dots +125 \text{ }^\circ\text{C}$
- made of self-extinguishing thermoplastic resin UL 94V-0
- mechanical life: ≥ 500 cycles
- contact resistance: $\leq 4 \text{ m}\Omega$
- for max. current load see the connector inserts derating diagrams below; for more information see page 28

female inserts (CTSEF)

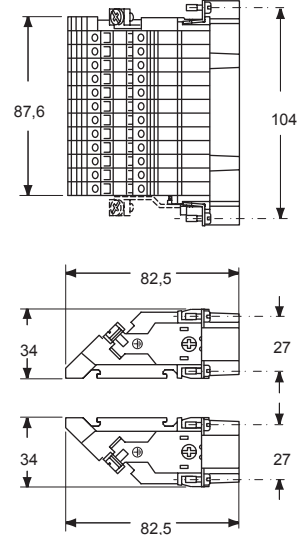


contacts side (front view)

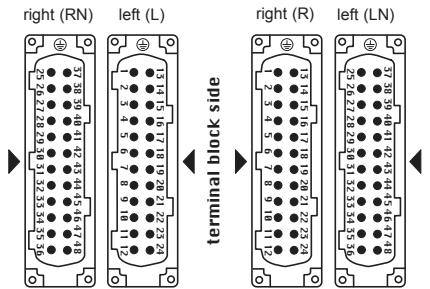
female inserts (CTSEF)



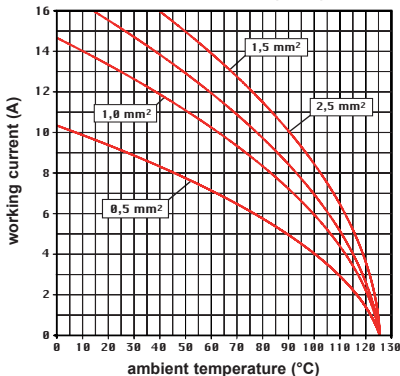
male inserts (CTSEM)



male inserts (CTSEM)

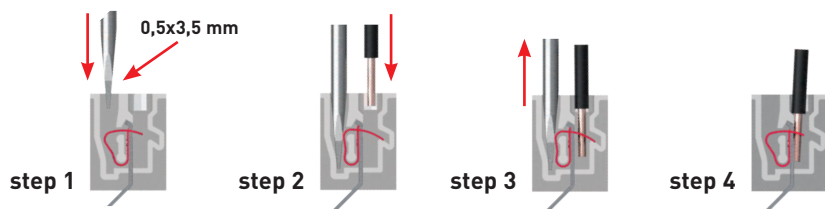


CTSE 48 poles connector inserts
Maximum current load derating diagram



- CTSE spring inserts for section conductors: 0,14 - 2,5 mm² - AWG 26 - 14
- conductors stripping length: 9...11 mm

Connection technology with spring terminal



CQE series

TECHNICAL FEATURES

CQE connector inserts are designed for removable crimp contacts series **CC** (solid pin \varnothing 2,5 mm), (including male pins **CC x.x AN** for advanced opening) with rated current up to **16A** per pole, and are the "high density" evolution of historic series **CCE**: in the same housing sizes, the number of pole (contact density) is increased as shown in this table:

Size	series CCE # of poles	series CQE # of poles	density increase
44.27	6 + ⊕	10 + ⊕	1,67
57.27	10 + ⊕	18 + ⊕	1,80
77.27	16 + ⊕	32 + ⊕	2,00
104.27	24 + ⊕	46 + ⊕	1,92
77.62	32 + ⊕ (2x16)	64 + ⊕ (2x32)	2,00
104.62	48 + ⊕ (2x24)	92 + ⊕ (2x46)	1,92

NOTE - The contact density is almost doubled in the same footprint by doubling the number of rows of contacts from 2 to 4. Except for size 77.27, which shows 4 rows of contacts seats equally dimensioned, central rows - due to space constraints to keep the required insulating distances towards the PE lateral contacts - are limited in number to one contact seat less than the peripheral rows.

This allows using the same size of connector housing for wiring almost twice the amount of circuits, or conversely to step down by one size the dimension of the connector housing to wire the same number of circuits, with cost and space efficiency. The only precaution is to suitably select the size of cable entry in case of increase of number of individual wires or diameter of a multi-core cable. Contact retention is operated by the retainers incorporated in the insulating body contact holder. Suitable removal tool **CQES**.

Inserts series		CQE
No. of poles ¹⁾	main contacts + ⊕	10, 18, 32, 46, (64 = 2x32), (92 = 2x46)
	auxiliary contacts	--
rated current ²⁾		16A
EN IEC 61984 pollution degree 3	rated voltage	500V
	rated impulse voltage	6kV
	pollution degree	3
EN IEC 61984 pollution degree 2	rated voltage	830V
	rated impulse voltage	8kV
	pollution degree	2
UL/CSA certification	rated voltage AC/DC	600V
contact resistance		≤ 1 mΩ
insulation resistance		≥ 10 GΩ
ambient temperature limit (°C)	min	-40 °C
	max	+125 °C
degree of protection	with enclosures	IP65, IP66/IP69, IP66/IP67/IP69, IP66/IP68/IP69 (according to type and model)
	without enclosures (in mated condition) - termination side on male and female inserts; - mating side on female inserts	IP20 (IPXXB)
conductor connections		crimp (⊕ only: screw)
conductor cross-sectional area	mm ²	0,14 - 2,5
	AWG	26 - 12
mechanical endurance (mating cycles)		≥ 500

1) Polarities shown in brackets may be obtained by using two inserts in their own double-sized housings

2) Please check the inserts derating diagrams to establish the actual maximum operating current according to the ambient temperature, the conductor cross-sectional area, the polarity of the connector, and any external constraint that may derive e.g. by the continuous operating temperature sustained by the chosen conductor sheathing or by end-product safety standards fixing max allowed temperature rise on terminals (e.g. 30 K, 45 K or 50 K)

Special voltages for CQE series

When all the contacts are used, CQE connector inserts may be used at rated voltage up to 500V (first column) pollution degree 3, in accordance with the standard EN 61984. If the number of contacts is reduced and the contacts accordingly assigned, these connectors may be used at higher voltages.

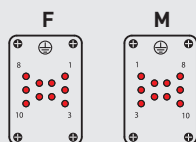
This is possible because the decrease in the number of contacts leads to an increase clearances and creepage distances.

When the contacts are arranged as shown below, the inserts may be used at rated voltages of 690V (second column) and 1000V (third column) pollution degree 3, in accordance with the standard EN 61984.

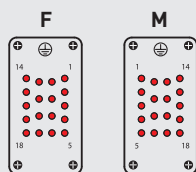
For use up to 500V pollution degree 3

diagrams
contacts side (front view)

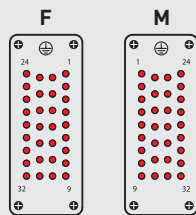
CQE 10 - 10 + ⊕



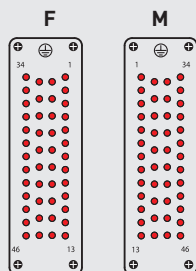
CQE 18 - 18 + ⊕



CQE 32 - 32 + ⊕



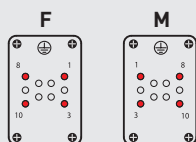
CQE 46 - 46 + ⊕



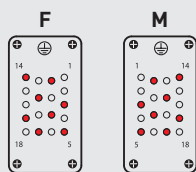
For use up to 690V pollution degree 3

diagrams
contacts side (front view)

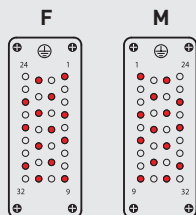
CQE 10 - 4 + ⊕



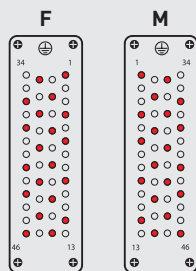
CQE 18 - 8 + ⊕



CQE 32 - 14 + ⊕



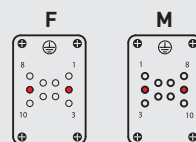
CQE 46 - 20 + ⊕



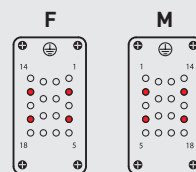
For use up to 1000V pollution degree 3

diagrams
contacts side (front view)

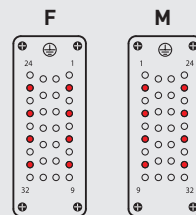
CQE 10 - 2 + ⊕



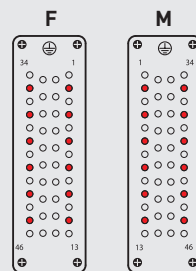
CQE 18 - 4 + ⊕



CQE 32 - 8 + ⊕



CQE 46 - 12 + ⊕



Legend:

- working contact
- without contact
- M = male insert
- F = female insert

CQE 10 poles + ⊕ 16A - 500V

enclosures: size "44.27"	page:
C-TYPE IP65 or IP66/IP69	387 - 392
C7 IP67, single lever	436 - 437
V-TYPE IP65 or IP66/IP69, single lever	444 - 447
BIG hoods	466 - 467
T-TYPE IP65 insulating	480 - 481
T-TYPE / W IP66/IP69 insulating	489
HYGIENIC T-TYPE / H IP66/IP69	501
HYGIENIC T-TYPE / C IP66/IP69, -50 °C	506
W-TYPE for aggressive environments	521
E-Xtreme® corrosion proof	530 - 531, 542, 550 - 551
EMC	578
Central lever	603 - 605
LS-TYPE	618 - 619
IP68	632 - 635

panel supports:	page:
COB	652 - 653

- for applications requiring higher voltages, please see the special voltage application section on page 167

inserts, crimp connections



16A crimp contacts standard or for advanced opening silver and gold plated



STANDARD

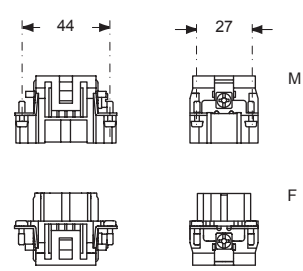
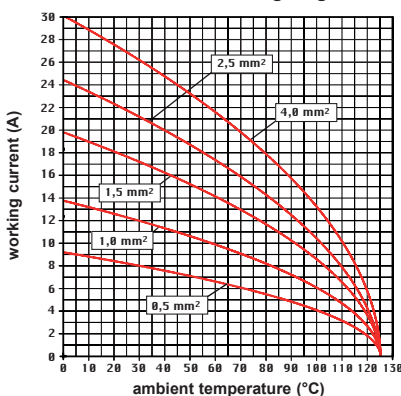


ADVANCED OPENING

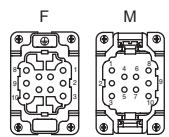
description	part No.	part No.	part No.
without contacts (to be ordered separately)			
female inserts for female contacts	CQEF 10		
male inserts for male contacts	CQEM 10		
16A female contacts			
0,14-0,37 mm ² AWG 26-22 one groove		CCFA 0.3	CCFD 0.3
0,5 mm ² AWG 20 with no grooves		CCFA 0.5	CCFD 0.5
0,75 mm ² AWG 18 one groove (back side)		CCFA 0.7	CCFD 0.7
1 mm ² AWG 18 one groove		CCFA 1.0	CCFD 1.0
1,5 mm ² AWG 16 two grooves		CCFA 1.5	CCFD 1.5
2,5 mm ² AWG 14 three grooves		CCFA 2.5	CCFD 2.5
3 mm ² AWG 12 one wide groove		CCFA 3.0	CCFD 3.0
4 mm ² AWG 12 with no grooves		CCFA 4.0	CCFD 4.0
16A male contacts			
0,14-0,37 mm ² AWG 26-22 one groove		CCMA 0.3	CCMD 0.3
0,5 mm ² AWG 20 with no grooves		CCMA 0.5	CCMD 0.5
0,75 mm ² AWG 18 one groove (back side)		CCMA 0.7	CCMD 0.7
1 mm ² AWG 18 one groove		CCMA 1.0	CCMD 1.0
1,5 mm ² AWG 16 two grooves		CCMA 1.5	CCMD 1.5
2,5 mm ² AWG 14 three grooves		CCMA 2.5	CCMD 2.5
3 mm ² AWG 12 one wide groove		CCMA 3.0	CCMD 3.0
4 mm ² AWG 12 with no grooves		CCMA 4.0	CCMD 4.0
16A male crimp contacts for advanced opening			
0,5 mm ² AWG 20 with no grooves		CC 0.5 AN	* for basic or high thickness gold plating, please refer to page 675
0,75 mm ² AWG 18 one groove (back side)		CC 0.7 AN	
1 mm ² AWG 18 one groove		CC 1.0 AN	
1,5 mm ² AWG 16 two grooves		CC 1.5 AN	
2,5 mm ² AWG 14 three grooves		CC 2.5 AN	

- characteristics according to EN 61984:
- 16A 500V 6kV 3**
- 16A 830V 8kV 2**
- cULus (UL for USA and Canada),
- certified
- rated voltage according to UL/CSA: 600V
- insulation resistance: ≥ 10 GΩ
- ambient temperature limit: -40 °C ... +125 °C
- made of self-extinguishing thermoplastic resin UL 94V-0
- mechanical life: ≥ 500 cycles
- contact resistance: ≤ 1 mΩ
- for max. current load see the connector inserts derating diagram below; for more information see page 28

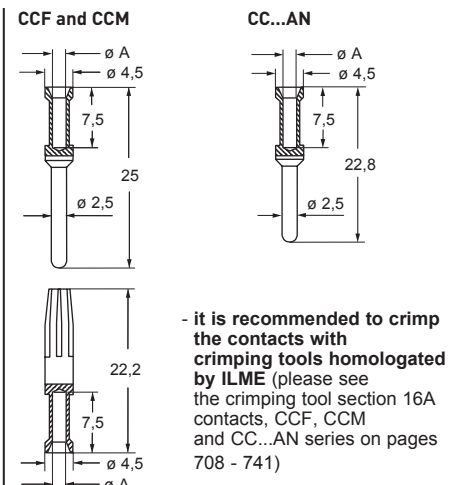
CQE 10 poles connector inserts
Maximum current load derating diagram



contacts side (front view)



CR CPQ coding pins (page 689)



- it is recommended to crimp the contacts with crimping tools homologated by ILME (please see the crimping tool section 16A contacts, CCF, CCM and CC...AN series on pages 708 - 741)

CCF, CCM and CC...AN contacts		
conductor section mm ²	conductor slot ø A (mm)	conductors stripping length (mm)
0,14-0,37	0,9	7,5
0,5	1,1	7,5
0,75	1,3	7,5
1,0	1,45	7,5
1,5	1,8	7,5
2,5	2,2	7,5
3	2,55	7,5
4	2,85	7,5

CQE 18 poles + ⊕ 16A - 500V

enclosures: size "57.27"	page:
C-TYPE IP65 or IP66/IP69	393 - 401
C7 IP67, two levers	438
V-TYPE IP65 or IP66/IP69, single lever	448 - 453
BIG hoods	468 - 469
T-TYPE IP65 insulating	482 - 483
T-TYPE / W IP66/IP69 insulating	490
HYGIENIC T-TYPE / H IP66/IP69	502
HYGIENIC T-TYPE / C IP66/IP69, -50 °C	507
W-TYPE for aggressive environments	522
E-Xtreme® corrosion proof	532 - 533, 543, 552 - 553
EMC	579
Central lever	606 - 608
LS-TYPE	620 - 621
IP68	636 - 639

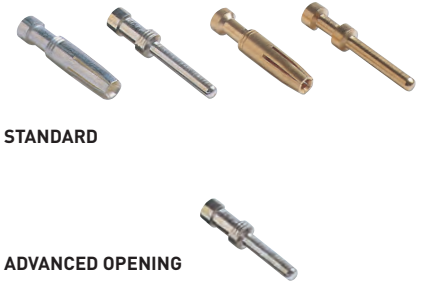
panel supports:	page:
COB	652 - 653

- for applications requiring higher voltages, please see the special voltage application section on page 167

inserts, crimp connections



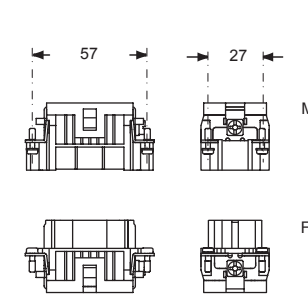
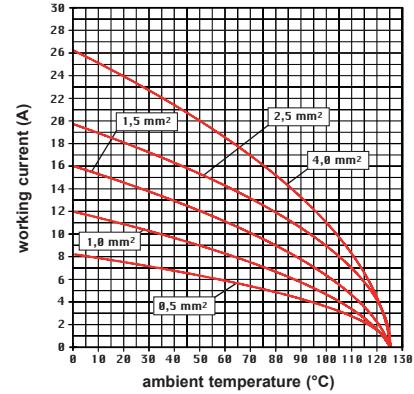
16A crimp contacts standard or for advanced opening silver and gold plated



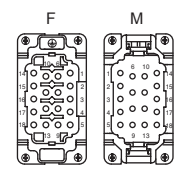
description	part No.	part No.	part No.
without contacts (to be ordered separately)			
female inserts for female contacts	CQEF 18		
male inserts for male contacts	CQEM 18		
16A female contacts			
0,14-0,37 mm ² AWG 26-22 one groove		CCFA 0.3	CCFD 0.3
0,5 mm ² AWG 20 with no grooves		CCFA 0.5	CCFD 0.5
0,75 mm ² AWG 18 one groove (back side)		CCFA 0.7	CCFD 0.7
1 mm ² AWG 18 one groove		CCFA 1.0	CCFD 1.0
1,5 mm ² AWG 16 two grooves		CCFA 1.5	CCFD 1.5
2,5 mm ² AWG 14 three grooves		CCFA 2.5	CCFD 2.5
3 mm ² AWG 12 one wide groove		CCFA 3.0	CCFD 3.0
4 mm ² AWG 12 with no grooves		CCFA 4.0	CCFD 4.0
16A male contacts			
0,14-0,37 mm ² AWG 26-22 one groove		CCMA 0.3	CCMD 0.3
0,5 mm ² AWG 20 with no grooves		CCMA 0.5	CCMD 0.5
0,75 mm ² AWG 18 one groove (back side)		CCMA 0.7	CCMD 0.7
1 mm ² AWG 18 one groove		CCMA 1.0	CCMD 1.0
1,5 mm ² AWG 16 two grooves		CCMA 1.5	CCMD 1.5
2,5 mm ² AWG 14 three grooves		CCMA 2.5	CCMD 2.5
3 mm ² AWG 12 one wide groove		CCMA 3.0	CCMD 3.0
4 mm ² AWG 12 with no grooves		CCMA 4.0	CCMD 4.0
16A male crimp contacts for advanced opening			
0,5 mm ² AWG 20 with no grooves		CC 0.5 AN	+ for basic or high thickness gold plating, please refer to page 675
0,75 mm ² AWG 18 one groove (back side)		CC 0.7 AN	
1 mm ² AWG 18 one groove		CC 1.0 AN	
1,5 mm ² AWG 16 two grooves		CC 1.5 AN	
2,5 mm ² AWG 14 three grooves		CC 2.5 AN	

- characteristics according to EN 61984:
- 16A 500V 6kV 3**
- 16A 830V 8kV 2**
- cULus (UL for USA and Canada),
- BUREAU VERITAS ENEC certified
- rated voltage according to UL/CSA: 600V
- insulation resistance: ≥ 10 GΩ
- ambient temperature limit: -40 °C ... +125 °C
- made of self-extinguishing thermoplastic resin UL 94V-0
- mechanical life: ≥ 500 cycles
- contact resistance: ≤ 1 mΩ
- for max. current load see the connector inserts derating diagram below; for more information see page 28

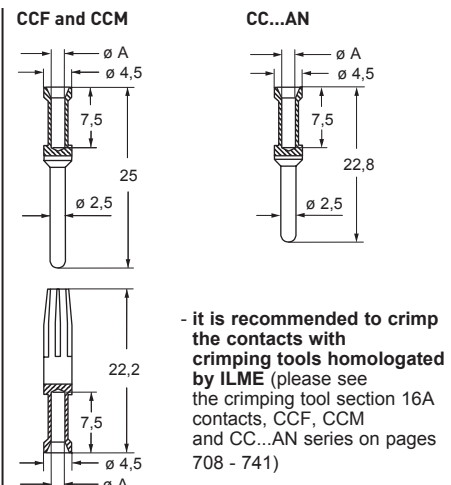
CQE 18 poles connector inserts
Maximum current load derating diagram



contacts side (front view)



CR CPQ coding pins (page 689)



- it is recommended to crimp the contacts with crimping tools homologated by ILME (please see the crimping tool section 16A contacts, CCF, CCM and CC...AN series on pages 708 - 741)

conductor section mm ²	conductor slot ø A (mm)	conductors stripping length (mm)
0,14-0,37	0,9	7,5
0,5	1,1	7,5
0,75	1,3	7,5
1,0	1,45	7,5
1,5	1,8	7,5
2,5	2,2	7,5
3	2,55	7,5
4	2,85	7,5

CQE

CQE 32 poles + ⊕ 16A - 500V

enclosures: size "77.27"	page:
C-TYPE IP65 or IP66/IP69	402 - 411
C7 IP67, two levers	439 - 440
V-TYPE IP65 or IP66/IP69, single lever	454 - 458
BIG hoods	470 - 471
T-TYPE IP65 insulating	484 - 485
T-TYPE / W IP66/IP69 insulating	491
HYGIENIC T-TYPE / H IP66/IP69	503
HYGIENIC T-TYPE / C IP66/IP69, -50 °C	508
W-TYPE for aggressive environments	523
E-Xtreme® corrosion proof	534 - 535, 544, 554 - 555
EMC	580
Central lever	609 - 611
LS-TYPE	622 - 623
IP68	640 - 643

panel supports:	page:
COB	652 - 653

- for applications requiring higher voltages, please see the special voltage application section on page 167

inserts, crimp connections



16A crimp contacts standard or for advanced opening silver and gold plated



STANDARD



ADVANCED OPENING

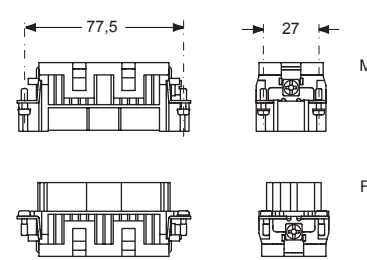
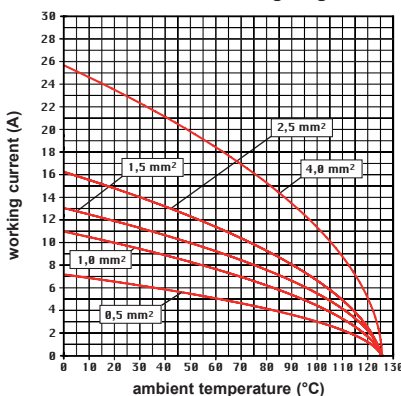
description	part No.	part No.	part No.
without contacts (to be ordered separately)			
female inserts for female contacts	CQEF 32		
male inserts for male contacts	CQEM 32		
16A female contacts			
0,14-0,37 mm ² AWG 26-22 one groove		CCFA 0.3	CCFD 0.3
0,5 mm ² AWG 20 with no grooves		CCFA 0.5	CCFD 0.5
0,75 mm ² AWG 18 one groove (back side)		CCFA 0.7	CCFD 0.7
1 mm ² AWG 18 one groove		CCFA 1.0	CCFD 1.0
1,5 mm ² AWG 16 two grooves		CCFA 1.5	CCFD 1.5
2,5 mm ² AWG 14 three grooves		CCFA 2.5	CCFD 2.5
3 mm ² AWG 12 one wide groove		CCFA 3.0	CCFD 3.0
4 mm ² AWG 12 with no grooves		CCFA 4.0	CCFD 4.0
16A male contacts			
0,14-0,37 mm ² AWG 26-22 one groove		CCMA 0.3	CCMD 0.3
0,5 mm ² AWG 20 with no grooves		CCMA 0.5	CCMD 0.5
0,75 mm ² AWG 18 one groove (back side)		CCMA 0.7	CCMD 0.7
1 mm ² AWG 18 one groove		CCMA 1.0	CCMD 1.0
1,5 mm ² AWG 16 two grooves		CCMA 1.5	CCMD 1.5
2,5 mm ² AWG 14 three grooves		CCMA 2.5	CCMD 2.5
3 mm ² AWG 12 one wide groove		CCMA 3.0	CCMD 3.0
4 mm ² AWG 12 with no grooves		CCMA 4.0	CCMD 4.0
16A male crimp contacts for advanced opening			
0,5 mm ² AWG 20 with no grooves		CC 0.5 AN	* for basic or high thickness gold plating, please refer to page 675
0,75 mm ² AWG 18 one groove (back side)		CC 0.7 AN	
1 mm ² AWG 18 one groove		CC 1.0 AN	
1,5 mm ² AWG 16 two grooves		CC 1.5 AN	
2,5 mm ² AWG 14 three grooves		CC 2.5 AN	

- characteristics according to EN 61984:
16A 500V 6kV 3
16A 830V 8kV 2

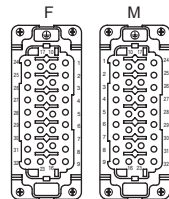
- cULus (UL for USA and Canada), certified

- rated voltage according to UL/CSA: 600V
 - insulation resistance: ≥ 10 GΩ
 - ambient temperature limit: -40 °C ... +125 °C
 - made of self-extinguishing thermoplastic resin UL 94V-0
 - mechanical life: ≥ 500 cycles
 - contact resistance: ≤ 1 mΩ
 - for max. current load see the connector inserts derating diagram below; for more information see page 28

CQE 32 poles connector inserts
Maximum current load derating diagram



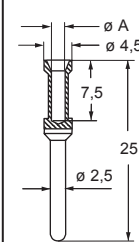
contacts side (front view)



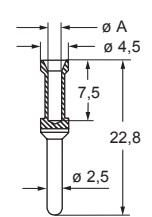
CR CPQ coding pins (page 689)



CCF and CCM



CC...AN



- it is recommended to crimp the contacts with crimping tools homologated by ILME (please see the crimping tool section 16A contacts, CCF, CCM and CC...AN series on pages 708 - 741)

CCF, CCM and CC...AN contacts

conductor section mm ²	conductor slot ø A (mm)	conductors stripping length (mm)
0,14-0,37	0,9	7,5
0,5	1,1	7,5
0,75	1,3	7,5
1,0	1,45	7,5
1,5	1,8	7,5
2,5	2,2	7,5
3	2,55	7,5
4	2,85	7,5

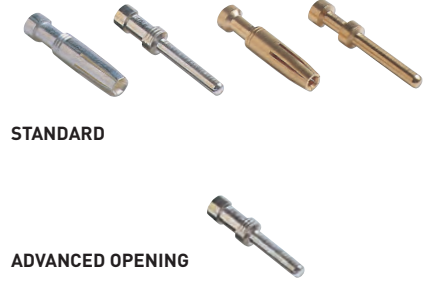
CQE 46 poles + ⊕ 16A - 500V

enclosures: size "104.27"	page:
C-TYPE IP65 or IP66/IP69	412 - 423
C7 IP67, two levers	441 - 442
V-TYPE IP65 or IP66/IP69, single lever	459 - 463
BIG hoods	472 - 473
T-TYPE IP65 insulating	486 - 487
T-TYPE / W IP66/IP69 insulating	492
HYGIENIC T-TYPE / H IP66/IP69	504
HYGIENIC T-TYPE / C IP66/IP69, -50 °C	509
W-TYPE for aggressive environments	524
E-Xtreme® corrosion proof	536 - 537, 545, 556 - 557
EMC	581
Central lever	612 - 614
LS-TYPE	624 - 625
IP68	644 - 647
panel supports: COB	page: 652 - 653

inserts, crimp connections



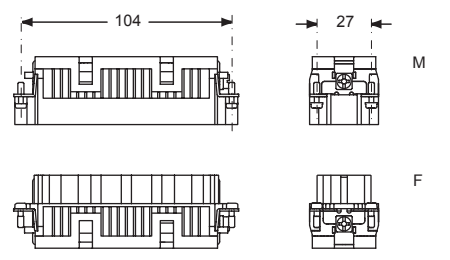
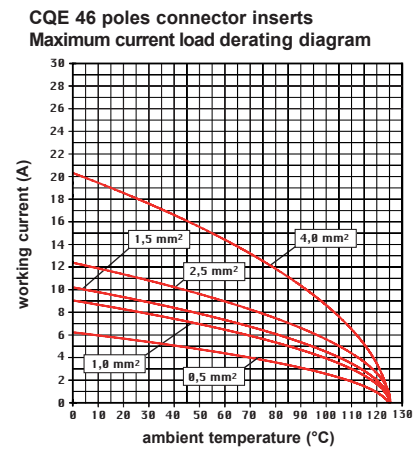
16A crimp contacts standard or for advanced opening silver and gold plated



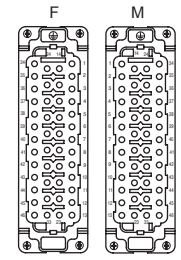
- for applications requiring higher voltages, please see the special voltage application section on page 167

description	part No.	part No.	part No.
without contacts (to be ordered separately)			
female inserts for female contacts	CQEF 46		
male inserts for male contacts	CQEM 46		
16A female contacts			
0,14-0,37 mm ² AWG 26-22 one groove		CCFA 0.3	CCFD 0.3
0,5 mm ² AWG 20 with no grooves		CCFA 0.5	CCFD 0.5
0,75 mm ² AWG 18 one groove (back side)		CCFA 0.7	CCFD 0.7
1 mm ² AWG 18 one groove		CCFA 1.0	CCFD 1.0
1,5 mm ² AWG 16 two grooves		CCFA 1.5	CCFD 1.5
2,5 mm ² AWG 14 three grooves		CCFA 2.5	CCFD 2.5
3 mm ² AWG 12 one wide groove		CCFA 3.0	CCFD 3.0
4 mm ² AWG 12 with no grooves		CCFA 4.0	CCFD 4.0
16A male contacts			
0,14-0,37 mm ² AWG 26-22 one groove		CCMA 0.3	CCMD 0.3
0,5 mm ² AWG 20 with no grooves		CCMA 0.5	CCMD 0.5
0,75 mm ² AWG 18 one groove (back side)		CCMA 0.7	CCMD 0.7
1 mm ² AWG 18 one groove		CCMA 1.0	CCMD 1.0
1,5 mm ² AWG 16 two grooves		CCMA 1.5	CCMD 1.5
2,5 mm ² AWG 14 three grooves		CCMA 2.5	CCMD 2.5
3 mm ² AWG 12 one wide groove		CCMA 3.0	CCMD 3.0
4 mm ² AWG 12 with no grooves		CCMA 4.0	CCMD 4.0
16A male crimp contacts for advanced opening			
0,5 mm ² AWG 20 with no grooves		CC 0.5 AN	* for basic or high thickness gold plating, please refer to page 675
0,75 mm ² AWG 18 one groove (back side)		CC 0.7 AN	
1 mm ² AWG 18 one groove		CC 1.0 AN	
1,5 mm ² AWG 16 two grooves		CC 1.5 AN	
2,5 mm ² AWG 14 three grooves		CC 2.5 AN	

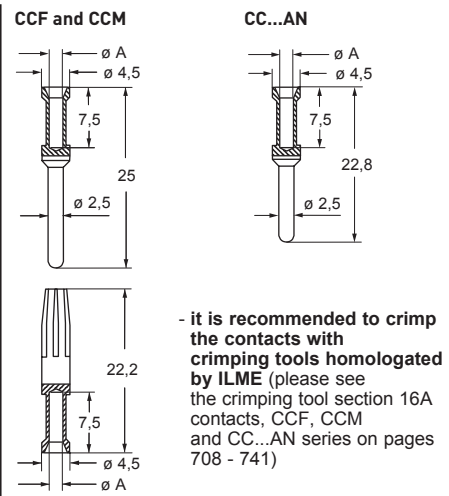
- characteristics according to EN 61984:
16A 500V 6kV 3
16A 830V 8kV 2
- cULus (UL for USA and Canada),
- BUREAU VERITAS ENEC certified
- rated voltage according to UL/CSA: 600V
- insulation resistance: ≥ 10 GΩ
- ambient temperature limit: -40 °C ... +125 °C
- made of self-extinguishing thermoplastic resin UL 94V-0
- mechanical life: ≥ 500 cycles
- contact resistance: ≤ 1 mΩ
- for max. current load see the connector inserts derating diagram below; for more information see page 28



contacts side (front view)



CR CPQ coding pins
(page 689)



CCF, CCM and CC...AN contacts

conductor section mm ²	conductor slot ø A (mm)	conductors stripping length (mm)
0,14-0,37	0,9	7,5
0,5	1,1	7,5
0,75	1,3	7,5
1,0	1,45	7,5
1,5	1,8	7,5
2,5	2,2	7,5
3	2,55	7,5
4	2,85	7,5

CQE 64 poles + ⊕ 16A - 500V

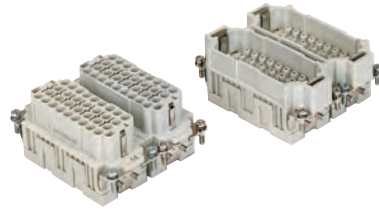
enclosures:
size "77.62"

page:

C-TYPE IP65 or IP66/IP69
W-TYPE for aggressive environments
E-Xtreme® corrosion proof

424 - 429
525
546

inserts, crimp connections



16A crimp contacts standard or for advanced opening silver and gold plated



STANDARD

ADVANCED OPENING



- for applications requiring higher voltages, please see the special voltage application section on page 167

description	part No.	part No.	part No.	part No.
without contacts (to be ordered separately)				
female inserts for female contacts, No. (1-32) and (33-64)	CQEF 32	CQEF 32 N		
male inserts for male contacts, No. (1-32) and (33-64)	CQEM 32	CQEM 32 N		
16A female contacts				
0,14-0,37 mm ² AWG 26-22 one groove			CCFA 0.3	CCFD 0.3
0,5 mm ² AWG 20 with no grooves			CCFA 0.5	CCFD 0.5
0,75 mm ² AWG 18 one groove (back side)			CCFA 0.7	CCFD 0.7
1 mm ² AWG 18 one groove			CCFA 1.0	CCFD 1.0
1,5 mm ² AWG 16 two grooves			CCFA 1.5	CCFD 1.5
2,5 mm ² AWG 14 three grooves			CCFA 2.5	CCFD 2.5
3 mm ² AWG 12 one wide groove			CCFA 3.0	CCFD 3.0
4 mm ² AWG 12 with no grooves			CCFA 4.0	CCFD 4.0
16A male contacts				
0,14-0,37 mm ² AWG 26-22 one groove			CCMA 0.3	CCMD 0.3
0,5 mm ² AWG 20 with no grooves			CCMA 0.5	CCMD 0.5
0,75 mm ² AWG 18 one groove (back side)			CCMA 0.7	CCMD 0.7
1 mm ² AWG 18 one groove			CCMA 1.0	CCMD 1.0
1,5 mm ² AWG 16 two grooves			CCMA 1.5	CCMD 1.5
2,5 mm ² AWG 14 three grooves			CCMA 2.5	CCMD 2.5
3 mm ² AWG 12 one wide groove			CCMA 3.0	CCMD 3.0
4 mm ² AWG 12 with no grooves			CCMA 4.0	CCMD 4.0
16A male crimp contacts for advanced opening				
0,5 mm ² AWG 20 with no grooves			CC 0.5 AN	* for basic or high thickness gold plating, please refer to page 675
0,75 mm ² AWG 18 one groove (back side)			CC 0.7 AN	
1 mm ² AWG 18 one groove			CC 1.0 AN	
1,5 mm ² AWG 16 two grooves			CC 1.5 AN	
2,5 mm ² AWG 14 three grooves			CC 2.5 AN	

- characteristics according to EN 61984:

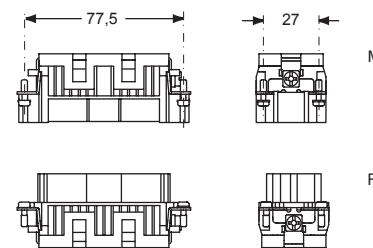
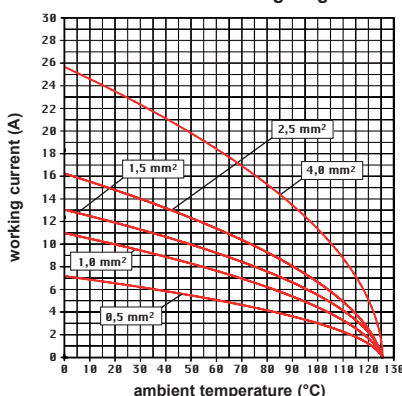
16A 500V 6kV 3
16A 830V 8kV 2

- cULus (UL for USA and Canada),

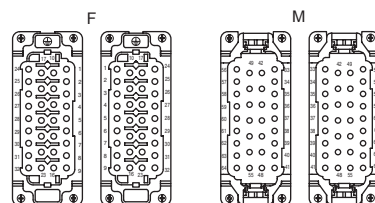
certified

- rated voltage according to UL/CSA: 600V
- insulation resistance: ≥ 10 GΩ
- ambient temperature limit: -40 °C ... +125 °C
- made of self-extinguishing thermoplastic resin UL 94V-0
- mechanical life: ≥ 500 cycles
- contact resistance: ≤ 1 mΩ
- for max. current load see the connector inserts derating diagram below; for more information see page 28

CQE 64 poles connector inserts
Maximum current load derating diagram



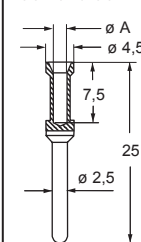
contacts side (front view)



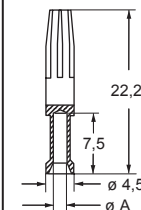
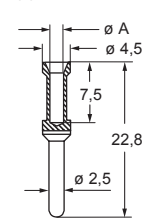
CR CPQ coding pins
(page 689)



CCF and CCM



CC...AN



- it is recommended to crimp the contacts with crimping tools homologated by ILME (please see the crimping tool section 16A contacts, CCF, CCM and CC...AN series on pages 705 - 741)

CCF, CCM and CC...AN contacts

conductor section mm ²	conductor slot diameter ø A (mm)	conductors stripping length (mm)
0,14-0,37	0,9	7,5
0,5	1,1	7,5
0,75	1,3	7,5
1,0	1,45	7,5
1,5	1,8	7,5
2,5	2,2	7,5
3	2,55	7,5
4	2,85	7,5

CQE 92 poles + ⊕ 16A - 500V

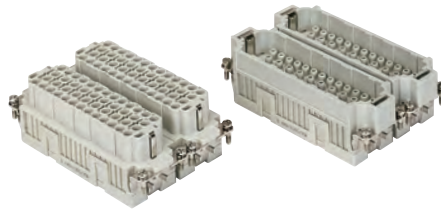
enclosures:
size "104.62"

page:

C-TYPE IP65 or IP66/IP69
W-TYPE for aggressive environments
E-Xtreme® corrosion proof

430
526
547

inserts, crimp connections



16A crimp contacts standard or for advanced opening silver and gold plated



STANDARD

ADVANCED OPENING

- for applications requiring higher voltages, please see the special voltage application section on page 167

description	part No.	part No.	part No.	part No.
without contacts (to be ordered separately)				
female inserts for female contacts, No. (1-46) and (47-92)	CQEF 46	CQEF 46 N		
male inserts for male contacts, No. (1-46) and (47-92)	CQEM 46	CQEM 46 N		
16A female contacts				
0,14-0,37 mm ² AWG 26-22 one groove			CCFA 0.3	CCFD 0.3
0,5 mm ² AWG 20 with no grooves			CCFA 0.5	CCFD 0.5
0,75 mm ² AWG 18 one groove (back side)			CCFA 0.7	CCFD 0.7
1 mm ² AWG 18 one groove			CCFA 1.0	CCFD 1.0
1,5 mm ² AWG 16 two grooves			CCFA 1.5	CCFD 1.5
2,5 mm ² AWG 14 three grooves			CCFA 2.5	CCFD 2.5
3 mm ² AWG 12 one wide groove			CCFA 3.0	CCFD 3.0
4 mm ² AWG 12 with no grooves			CCFA 4.0	CCFD 4.0
16A male contacts				
0,14-0,37 mm ² AWG 26-22 one groove			CCMA 0.3	CCMD 0.3
0,5 mm ² AWG 20 with no grooves			CCMA 0.5	CCMD 0.5
0,75 mm ² AWG 18 one groove (back side)			CCMA 0.7	CCMD 0.7
1 mm ² AWG 18 one groove			CCMA 1.0	CCMD 1.0
1,5 mm ² AWG 16 two grooves			CCMA 1.5	CCMD 1.5
2,5 mm ² AWG 14 three grooves			CCMA 2.5	CCMD 2.5
3 mm ² AWG 12 one wide groove			CCMA 3.0	CCMD 3.0
4 mm ² AWG 12 with no grooves			CCMA 4.0	CCMD 4.0
16A male crimp contacts for advanced opening				
0,5 mm ² AWG 20 with no grooves			CC 0.5 AN	+ for basic or high thickness gold plating, please refer to page 675
0,75 mm ² AWG 18 one groove (back side)			CC 0.7 AN	
1 mm ² AWG 18 one groove			CC 1.0 AN	
1,5 mm ² AWG 16 two grooves			CC 1.5 AN	
2,5 mm ² AWG 14 three grooves			CC 2.5 AN	

- characteristics according to EN 61984:

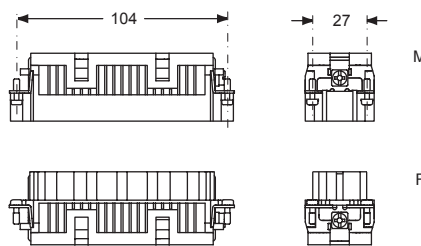
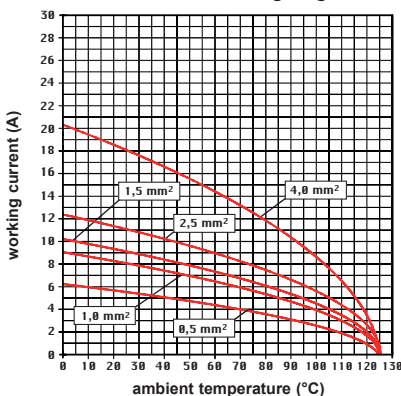
16A 500V 6kV 3
16A 830V 8kV 2

- cULus (UL for USA and Canada),

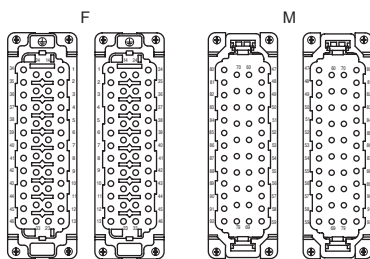
certified

- rated voltage according to UL/CSA: 600V
- insulation resistance: ≥ 10 GΩ
- ambient temperature limit: -40 °C ... +125 °C
- made of self-extinguishing thermoplastic resin UL 94V-0
- mechanical life: ≥ 500 cycles
- contact resistance: ≤ 1 mΩ
- for max. current load see the connector inserts derating diagram below; for more information see page 28

CQE 92 poles connector inserts
Maximum current load derating diagram



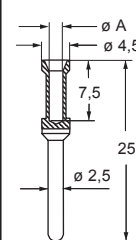
contacts side (front view)



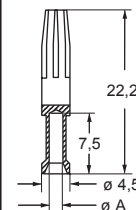
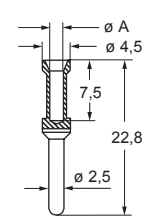
CR CPQ coding pins
(page 689)



CCF and CCM



CC...AN



- it is recommended to crimp the contacts with crimping tools homologated by ILME (please see the crimping tool section 16A contacts, CCF, CCM and CC...AN series on pages 705 - 741)

CCF, CCM and CC...AN contacts

conductor section mm ²	conductor slot ø A (mm)	conductors stripping length (mm)
0,14-0,37	0,9	7,5
0,5	1,1	7,5
0,75	1,3	7,5
1,0	1,45	7,5
1,5	1,8	7,5
2,5	2,2	7,5
3	2,55	7,5
4	2,85	7,5

CQEE series

TECHNICAL FEATURES

Connector inserts series **CQEE** are the logical extension of the existing series CQE for removable crimp contacts series CC (16A max, available both in gold plated and in silver plated version) that include the CC...AN pin contacts with anticipated opening (first-to-break) and delayed closing (last-to-make).

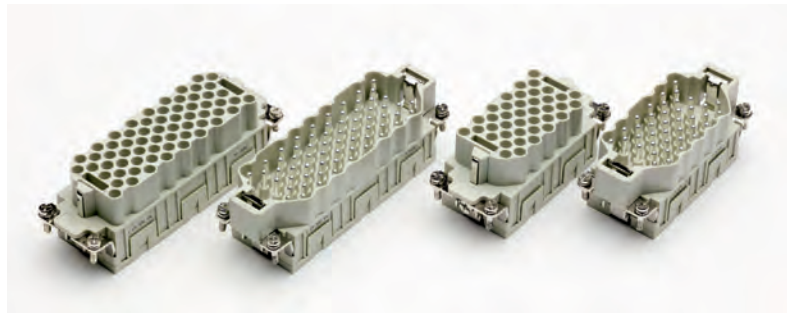
Compared with the connector inserts of the same size of series CQE, connector inserts series **CQEE** provide a sensibly higher number of contacts: 64P+⊕ instead of 46P+⊕ for size 104.27 (+39%), 40P+⊕ instead of 32P+⊕ for size 77.27 (+25%).

With the same number of circuits, it is conversely possible to reduce the size of the connector inserts and of the related hood and housing, thus reducing the overall cost.

Connector inserts series **CQEE** may replace in the same size (77.27, 104.27) and with the same contact density (40P+⊕ and 64P+⊕) the corresponding inserts of series CD for removable crimp contacts series CD (10A max).

This may be particularly useful when, as a function of the intended use, it is required:

- to use the connector at a higher rated voltage: CQEE covers use at 500V / 6kV / 3 where CD stops at 250V / 4kV / 3;
- to assign a larger current-carrying capacity, both due to the lower contact resistance (1 mΩ instead of 3 mΩ) and the larger wire size available for series CC compared with series CD contacts;
- to use wires with the larger cross-sectional area of 4 mm² / AWG 12, in order to contain the percent voltage drop [%] in circuits fed with extra-low voltage and with comparatively high currents, or in circuits of considerable length;
- to use crimp contacts with inherently higher mechanical robustness;
- to use anticipated pin contacts CC...AN (e.g. for the remote signal ling of the "OPEN" or "CLOSED" status of the connector).



CQEE series

TECHNICAL FEATURES

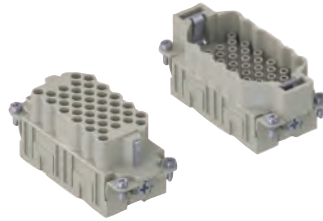
Inserts series		CQEE
No. of poles	main contacts + ⊕	40 + ⊕, 64 + ⊕
rated current ¹⁾		16A
EN 61984 pollution degree 3	rated voltage	500V
	rated impulse voltage	6kV
	pollution degree	3
EN 61984 pollution degree 2	rated voltage	830V
	rated impulse voltage	6kV
	pollution degree	2
UL/CSA certification	rated voltage AC/DC	600V
contact resistance		≤ 1 mΩ
insulation resistance		≥ 10 GΩ
ambient temperature limit (°C)	min	-40 °C
	max	+125 °C
degree of protection	with enclosures (according to version)	IP65, IP66/IP69, IP66/IP67/IP69, IP66/IP68/IP69 (according to type and model)
	without enclosures (in mated condition)	IP20 (IPXXB)
conductor connections		crimp (only ⊕: screw)
conductor cross-section (CC contact series)	mm ²	0,14 4,0
	AWG	26 - 12
stripping length	mm	7,5
mechanical endurance (mating cycles)		≥ 500

¹⁾ Please check the inserts derating diagrams to establish the actual maximum operating current according to the ambient temperature, the conductor cross-sectional area, the polarity of the connector, and any external constraint that may derive e.g. by the continuous operating temperature sustained by the chosen conductor sheathing or by end-product safety standards fixing max allowed temperature rise on terminals (e.g. 30 K, 45 K or 50 K)

CQEE 40 poles + ⊕ 16A - 500V

enclosures: size "77.27"	page:
C-TYPE IP65 or IP66/IP69	402 - 411
C7 IP67, two levers	439 - 440
V-TYPE IP65 or IP66/IP69, single lever	454 - 458
BIG hoods	470 - 471
T-TYPE IP65 insulating	484 - 485
T-TYPE / W IP66/IP69 insulating	491
HYGIENIC T-TYPE / H IP66/IP69	503
HYGIENIC T-TYPE / C IP66/IP69, -50 °C	508
W-TYPE for aggressive environments	523
E-Xtreme® corrosion proof	534 - 535, 544, 554 - 555
EMC	580
Central lever	609 - 611
LS-TYPE	622 - 623
IP68	640 - 643
panel supports: COB	page: 652 - 653

inserts, crimp connections



16A crimp contacts
standard or for advanced opening
silver and gold plated



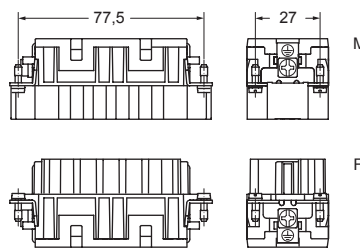
STANDARD



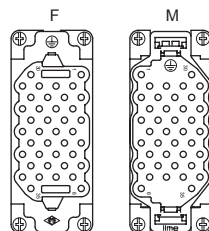
ADVANCED OPENING

description	part No.	part No.	part No.
without contacts (to be ordered separately)			
female inserts for female contacts	CQEEF 40		
male inserts for male contacts	CQEEM 40		
16A female contacts			
0,14-0,37 mm ² AWG 26-22 one groove		CCFA 0.3	CCFD 0.3
0,5 mm ² AWG 20 with no grooves		CCFA 0.5	CCFD 0.5
0,75 mm ² AWG 18 one groove (back side)		CCFA 0.7	CCFD 0.7
1 mm ² AWG 18 one groove		CCFA 1.0	CCFD 1.0
1,5 mm ² AWG 16 two grooves		CCFA 1.5	CCFD 1.5
2,5 mm ² AWG 14 three grooves		CCFA 2.5	CCFD 2.5
3 mm ² AWG 12 one wide groove		CCFA 3.0	CCFD 3.0
4 mm ² AWG 12 with no grooves		CCFA 4.0	CCFD 4.0
16A male contacts			
0,14-0,37 mm ² AWG 26-22 one groove		CCMA 0.3	CCMD 0.3
0,5 mm ² AWG 20 with no grooves		CCMA 0.5	CCMD 0.5
0,75 mm ² AWG 18 one groove (back side)		CCMA 0.7	CCMD 0.7
1 mm ² AWG 18 one groove		CCMA 1.0	CCMD 1.0
1,5 mm ² AWG 16 two grooves		CCMA 1.5	CCMD 1.5
2,5 mm ² AWG 14 three grooves		CCMA 2.5	CCMD 2.5
3 mm ² AWG 12 one wide groove		CCMA 3.0	CCMD 3.0
4 mm ² AWG 12 with no grooves		CCMA 4.0	CCMD 4.0
16A male crimp contacts for advanced opening			
0,5 mm ² AWG 20 with no grooves		CC 0.5 AN	* for basic or high thickness gold plating, please refer to page 675
0,75 mm ² AWG 18 one groove (back side)		CC 0.7 AN	
1 mm ² AWG 18 one groove		CC 1.0 AN	
1,5 mm ² AWG 16 two grooves		CC 1.5 AN	
2,5 mm ² AWG 14 three grooves		CC 2.5 AN	

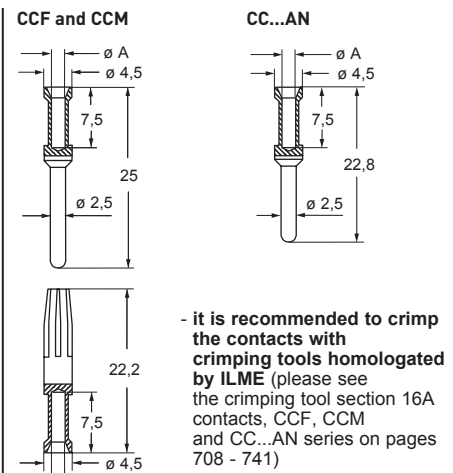
- characteristics according to EN 61984:
16A 500V 6kV 3
- certified
- rated voltage according to UL/CSA: 600V
- insulation resistance: ≥ 10 GΩ
- ambient temperature limit: -40 °C ... +125 °C
- made of self-extinguishing thermoplastic resin UL 94V-0
- mechanical life: ≥ 500 cycles
- contact resistance: ≤ 1 mΩ
- for max. current load see the connector inserts derating diagram below; for more information see page 28



contacts side (front view)



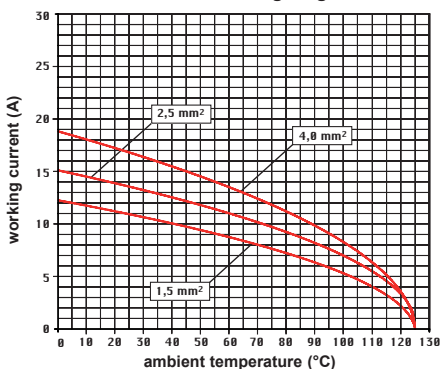
CR CPQ coding pins (page 689)



- it is recommended to crimp the contacts with crimping tools homologated by ILME (please see the crimping tool section 16A contacts, CCF, CCM and CC...AN series on pages 708 - 741)

conductor section mm ²	conductor slot ø A (mm)	conductors stripping length (mm)
0,14-0,37	0,9	7,5
0,5	1,1	7,5
0,75	1,3	7,5
1,0	1,45	7,5
1,5	1,8	7,5
2,5	2,2	7,5
3	2,55	7,5
4	2,85	7,5

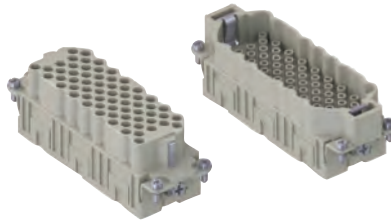
CQEE 40 poles connector inserts
Maximum current load derating diagram



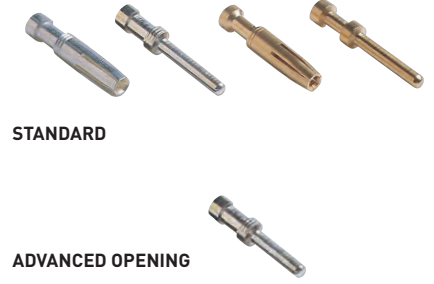
CQEE 64 poles + ⊕ 16A - 500V

enclosures: size "104.27"	page:
C-TYPE IP65 or IP66/IP69	412 - 423
C7 IP67, two levers	441 - 442
V-TYPE IP65 or IP66/IP69, single lever	459 - 463
BIG hoods	472 - 473
T-TYPE IP65 insulating	486 - 487
T-TYPE / W IP66/IP69 insulating	492
HYGIENIC T-TYPE / H IP66/IP69	504
HYGIENIC T-TYPE / C IP66/IP69, -50 °C	509
W-TYPE for aggressive environments	524
E-Xtreme® corrosion proof	536 - 537, 545, 556 - 557
EMC	581
Central lever	612 - 614
LS-TYPE	624 - 625
IP68	644 - 647
panel supports: COB	page: 652 - 653

inserts, crimp connections

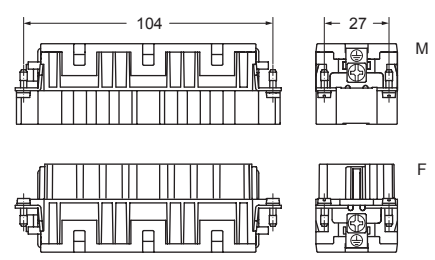
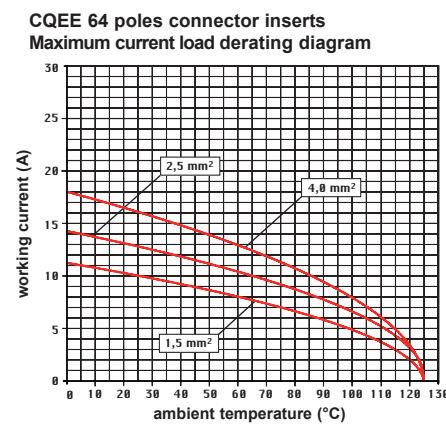


16A crimp contacts
standard or for advanced opening
silver and gold plated

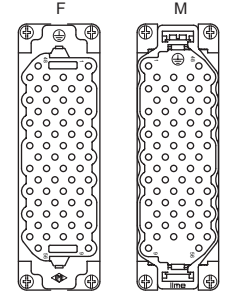


description	part No.	part No.	part No.
without contacts (to be ordered separately)			
female inserts for female contacts	CQEEF 64		
male inserts for male contacts	CQEEM 64		
16A female contacts			
0,14-0,37 mm ² AWG 26-22 one groove		CCFA 0.3	CCFD 0.3
0,5 mm ² AWG 20 with no grooves		CCFA 0.5	CCFD 0.5
0,75 mm ² AWG 18 one groove (back side)		CCFA 0.7	CCFD 0.7
1 mm ² AWG 18 one groove		CCFA 1.0	CCFD 1.0
1,5 mm ² AWG 16 two grooves		CCFA 1.5	CCFD 1.5
2,5 mm ² AWG 14 three grooves		CCFA 2.5	CCFD 2.5
3 mm ² AWG 12 one wide groove		CCFA 3.0	CCFD 3.0
4 mm ² AWG 12 with no grooves		CCFA 4.0	CCFD 4.0
16A male contacts			
0,14-0,37 mm ² AWG 26-22 one groove		CCMA 0.3	CCMD 0.3
0,5 mm ² AWG 20 with no grooves		CCMA 0.5	CCMD 0.5
0,75 mm ² AWG 18 one groove (back side)		CCMA 0.7	CCMD 0.7
1 mm ² AWG 18 one groove		CCMA 1.0	CCMD 1.0
1,5 mm ² AWG 16 two grooves		CCMA 1.5	CCMD 1.5
2,5 mm ² AWG 14 three grooves		CCMA 2.5	CCMD 2.5
3 mm ² AWG 12 one wide groove		CCMA 3.0	CCMD 3.0
4 mm ² AWG 12 with no grooves		CCMA 4.0	CCMD 4.0
16A male crimp contacts for advanced opening			
0,5 mm ² AWG 20 with no grooves		CC 0.5 AN	* for basic or high thickness gold plating, please refer to page 675
0,75 mm ² AWG 18 one groove (back side)		CC 0.7 AN	
1 mm ² AWG 18 one groove		CC 1.0 AN	
1,5 mm ² AWG 16 two grooves		CC 1.5 AN	
2,5 mm ² AWG 14 three grooves		CC 2.5 AN	

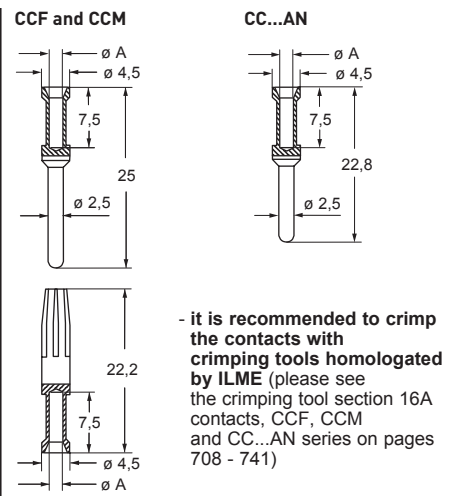
- characteristics according to EN 61984:
- 16A 500V 6kV 3**
- cULus (UL for USA and Canada), certified
- rated voltage according to UL/CSA: 600V
- insulation resistance: ≥ 10 GΩ
- ambient temperature limit: -40 °C ... +125 °C
- made of self-extinguishing thermoplastic resin UL 94V-0
- mechanical life: ≥ 500 cycles
- contact resistance: ≤ 1 mΩ
- for max. current load see the connector derating diagram below; for more information see page 28



contacts side (front view)



CR CPQ coding pins
(page 689)



- it is recommended to crimp the contacts with crimping tools homologated by ILME (please see the crimping tool section 16A contacts, CCF, CCM and CC...AN series on pages 708 - 741)

CCF, CCM and CC...AN contacts

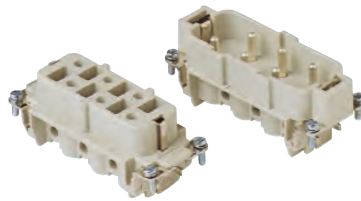
conductor section mm ²	conductor slot ø A (mm)	conductors stripping length (mm)
0,14-0,37	0,9	7,5
0,5	1,1	7,5
0,75	1,3	7,5
1,0	1,45	7,5
1,5	1,8	7,5
2,5	2,2	7,5
3	2,55	7,5
4	2,85	7,5

CQEE

CP - CP...RY 6 poles + ⊕ 35A - 400/690V

enclosures: size "77.27"	page:
CP 06:	
C-TYPE IP65 or IP66/IP69	402 - 411
C7 IP67, two levers	439 - 440
V-TYPE IP65 or IP66/IP69, single lever	454 - 458
BIG hoods	470 - 471
T-TYPE IP65 insulating	484 - 485
T-TYPE / W IP66/IP69 insulating	491
HYGIENIC T-TYPE / H IP66/IP69	503
HYGIENIC T-TYPE / C IP66/IP69, -50 °C	508
W-TYPE for aggressive environments	523
E-Xtreme® corrosion proof	534 - 535, 544, 554 - 555
EMC	580
Central lever	609 - 611
LS-TYPE	622 - 623
IP68	640 - 643
panel supports:	page:
COB	652 - 653
CP 06 RY:	
For 180 °C	588

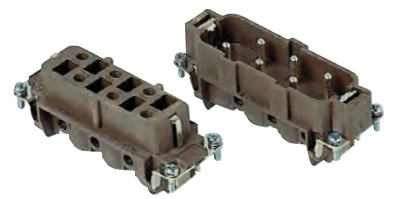
inserts, screw terminal connection



Q SILVER PLATED CONTACTS

part No.

inserts, screw terminal connection



180 °C

Q SILVER PLATED CONTACTS

part No.

description

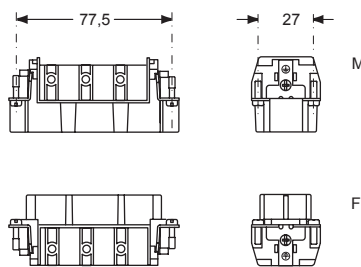
indirect, with plate
female inserts with female contacts
male inserts with male contacts

CPF 06
CPM 06

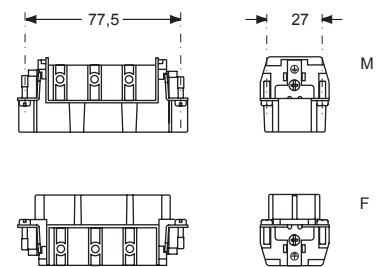
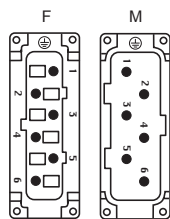
indirect, with plate, use in temperatures up to 180 °C
female inserts with female contacts, brown
male inserts with male contacts, brown

CPF 06 RY
CPM 06 RY

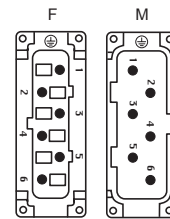
- characteristics according to EN 61984:
- 35A 400/690V 6kV 3**
- certified
- rated voltage according to UL/CSA: 600V
- insulation resistance: ≥ 10 GΩ
- ambient temperature limit: -40 °C ... +125 °C (CP RY version up to 180 °C)
- made of self-extinguishing thermoplastic resin UL 94V-0
- mechanical life: ≥ 500 cycles
- contact resistance: ≤ 0,5 mΩ
- for max. current load see the connector inserts derating diagrams below; for more information see page 28



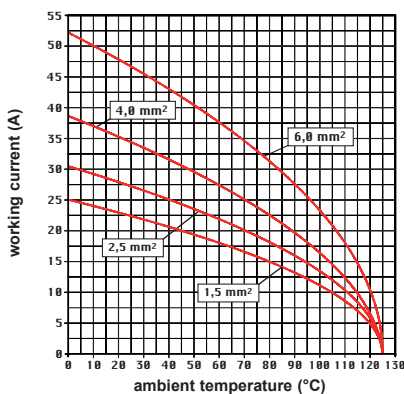
contacts side (front view)



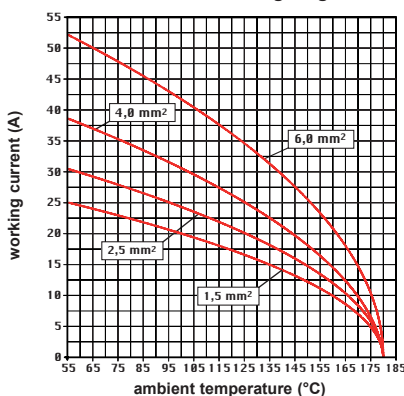
contacts side (front view)



CP 06 poles connector inserts
Maximum current load derating diagram



CP...RY 06 poles connector inserts
Maximum current load derating diagram



- inserts with plate, for section conductors: 0,75 - 6 mm² - AWG 18 - 10
- conductors stripping length: 10,5 mm
- terminal screw torque: 1,2 Nm (10,7 lb.in), information see page 20 and 21

- inserts with plate, for section conductors: 0,75 - 6 mm² - AWG 18 - 10
- conductors stripping length: 10,5 mm
- terminal screw torque: 1,2 Nm (10,7 lb.in), information see page 20 and 21

CP 12 poles + ⊕ 35A - 400/690V

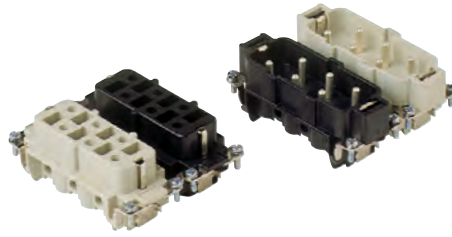
enclosures:
size "77.62"

page:

C-TYPE IP65 or IP66/IP69
W-TYPE for aggressive environments
E-Xtreme® corrosion proof

424 - 429
525
546

inserts, screw terminal connection



Q SILVER PLATED CONTACTS

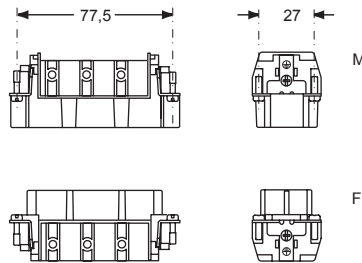
description	part No.	part No.
indirect, with plate female inserts No. (1-6), white and black male inserts No. (1-6), white and black	CPF 06 CPM 06	CPF 06 N CPM 06 N

- characteristics according to EN 61984:

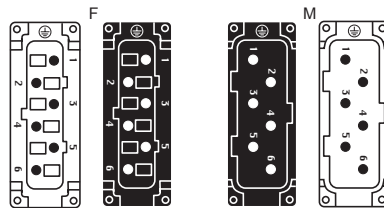
35A 400/690V 6kV 3

- certified

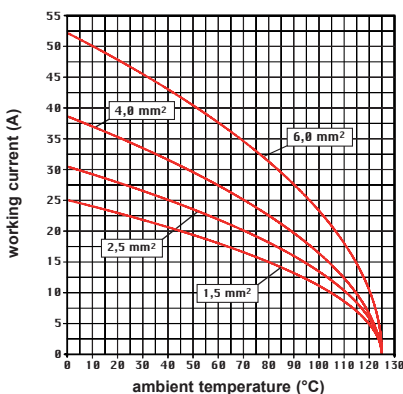
- rated voltage according to UL/CSA: 600V
- insulation resistance: $\geq 10 \text{ G}\Omega$
- ambient temperature limit: $-40 \text{ }^\circ\text{C} \dots +125 \text{ }^\circ\text{C}$
(CP RY version up to $180 \text{ }^\circ\text{C}$)
- made of self-extinguishing thermoplastic resin UL 94V-0
- mechanical life: ≥ 500 cycles
- contact resistance: $\leq 0,5 \text{ m}\Omega$
- for max. current load see the connector inserts derating diagrams below; for more information see page 28



contacts side (front view)



CP 12 poles connector inserts
Maximum current load derating diagram



- inserts with plate, for section conductors: 0,75 - 6 mm² - AWG 18 - 10
- conductors stripping length: 10,5 mm
- terminal screw torque: 1,2 Nm (10,7 lb.in), information see page 20 and 21

CQ4 (CQ4F /M 02 – CQ4F /M 02 H – CQ4F /M 03)

Compact size “21.21” for high current or higher voltage

- Compact size “21.21” **2P+PE** and **3P+PE** connector inserts for **high current (40 A)**, and either standard voltage up to 400 V or **higher voltage 830 V**, ideally complemented by the expanding range of hoods and housings size “21.21” with **M25** threaded cable entry, either insulating or metallic (**MK, MKA, MGK**), which are particularly suitable for use with high cross-sectional area conductors (large cable diameter).

- Series **CQ4** encompasses the following size “21.21” connector inserts:

› **CQ4F /M 03** with 3P+PE with up to 40 A current-carrying capacity and standard rated voltage up to 400 V (e.g. for 3-phase motor connections);

› **CQ4F /M 02** with 2P+PE with up to 40 A current-carrying capacity and standard rated voltage up to 400 V (e.g. for 1-phase AC or for DC power connections), this one with better current-carrying capacity by the derating diagrams, due to a power contact less in the same space;

› **CQ4F /M 02 H** with 2P+PE with up to 40 A current-carrying capacity and higher rated voltage applications, up to **830 V** (for 1-phase AC or for DC higher power connections).

- Suitable for series **CX** crimp contacts (including the **PE pre-leading one**), covering stranded copper conductors cross sectional area range **1,5 mm² to 10 mm²** (16 AWG to 8 AWG).

- Protection against direct contact when unmated:

› **CQ4F 02**: both male and female connector inserts are **fingerproof (IP2X)** even on the mating face when uncoupled (useful e.g. when a male connector is on the motor side of a drive including capacitors, potentially charged for residual time).

› **CQ4F 03**: the female insert is **fingerproof (IP2X)** even on the mating face when uncoupled, while the male insert **CQ4M 03** in that circumstance is protected from access with the back of the hand (IP1X).

- **CQ4F /M 02** and **CQ4F /M 02 H** specific features:

› Special **polarisation key** on the connector bodies mating face of both versions, differently oriented, to avoid the mismatching of CQ4F /M 02 H **830 V** version with the lower voltage CQ4F /M 02 **400 V** version.

› **CQ4F /M 02 H** supplied with a **special insulating heat-shrinking tube** that provides the required additional insulation towards a metal housing.

› **CQ4F /M 02 H** specific **830 V** rated voltage duly marked on the inserts, to avoid any possible confusion with similar CQ4F /M 02 for 400 V.

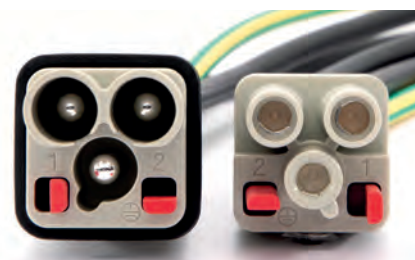
- Codings:

› **CQ4 03**: possibility of up to **4 different codings** thanks to the use of the **optional CR Q03 coding pin** (4 possible positions);

› **CQ4 02** and **CQ4 02 H**: possibility of up to **16 different codings** thanks to the use of **two optional CR Q02 coding pins** (it is possible to install two pins with 4 positions each).



CQ4F/M 02
Lower voltage version



CQ4F/M 02 H
Higher 830V voltage version

CQ4 series

TECHNICAL FEATURES

Inserts series		CQ4		
Cat. No.		CQ4F /M 02	CQ4F /M 02 H	CQ4F /M 03
No. of poles		2 + ⊕	2 + ⊕	3 + ⊕
rated current ¹⁾		40 A		
EN 61984 pollution degree 3	rated voltage	400 V	830 V	400 V
	rated impulse voltage	6 kV		
	pollution degree	3		
contact resistance		≤ 0,3 mΩ		
insulation resistance		≥ 10 GΩ		
ambient temperature limit (°C) (°C)	min. max.	-40 °C +125 °C		
degree of protection	with enclosures (according to version)	IP44, IP65, IP66, IP67, IP68, IP69		
	without enclosures: - in mated condition	IP20 IP20 (IPXXB)		
	- termination side on male and female inserts	IP20 (IPXXB)		
	- mating side on female inserts - mating side on male inserts	IP20 (IPXXB)	IP1X (IPXXA)	
conductor connections		crimp		
conductor cross-sectional area	mm ²	1,5 ... 10		
	AWG	16 ... 8		
stripping length	mm	9 – 9,6 – 15 (according to contact size)		
mechanical endurance (mating cycles)		≥ 500		

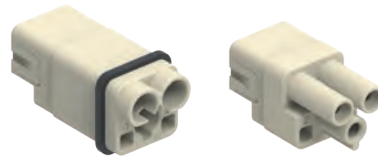
¹⁾ See derating diagrams

CQ4F/M 02 2 poles + ⊕ 40A - 400V

enclosures: size "21.21"	page:
Insulating type	339 - 348
Metallic type	349 - 363
W-TYPE for aggressive environments	512 - 518
EMC	564 - 572
IP68	628 - 631
E-Xtreme® corrosion proof	538 - 539

- cannot be used in angled enclosures (IA/IAP/VA version)

inserts, crimp connections



40A crimp contacts silver plated



description	part No.	part No.
-------------	----------	----------

without contacts (to be ordered separately), including PE female inserts for female contacts
male inserts for male contacts

CQ4F 02
CQ4M 02

40A female crimp contacts

1,5 mm ²	AWG 16
2,5 mm ²	AWG 14
4 mm ²	AWG 12
6 mm ²	AWG 10
10 mm ²	AWG 8

40A male crimp contacts

1,5 mm ²	AWG 16
2,5 mm ²	AWG 14
4 mm ²	AWG 12
6 mm ²	AWG 10
10 mm ²	AWG 8

CXFA 1.5
CXFA 2.5
CXFA 4.0
CXFA 6.0
CXFA 10

silver plated

CXMA 1.5
CXMA 2.5
CXMA 4.0
CXMA 6.0
CXMA 10

- characteristics according to EN 61984:

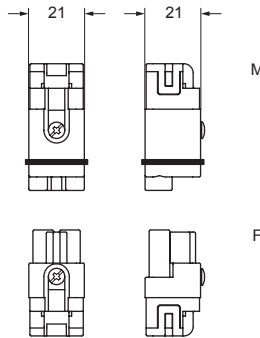
40A 400V 6kV 3

- cULus (UL for USA and Canada),

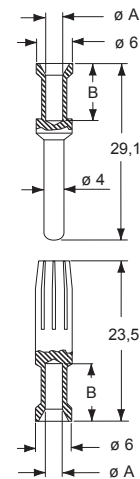
ERC certified

- rated voltage according to UL/CSA: 600V
- insulation resistance: ≥ 10 GΩ
- ambient temperature limit: -40 °C ... +125 °C
- made of self-extinguishing thermoplastic resin UL 94V-0
- mechanical life: ≥ 500 cycles
- contact resistance: ≤ 0,3 mΩ
- **it is recommended to crimp the contacts with crimping tools homologated by ILME** (please see the crimping tool section 40A contacts CXF and CXM series, on pages 708 - 741)
- for max. current load see the connector inserts derating diagram below; for more information see page 28

- wire diameter: up to 7,5 mm
conductor cross-sectional area: up to 10 mm²



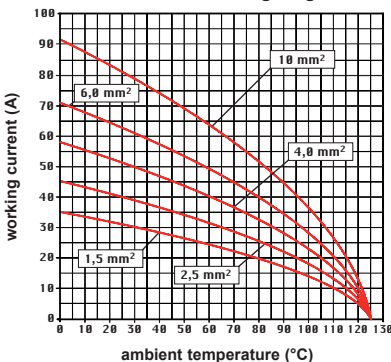
contacts side (front view)



CXF and CXM contacts

conductor cross-sectional area (mm ²)	conductor slot ø A (mm)	conductor stripping length B (mm)
1,5	1,8	9
2,5	2,2	9
4	2,85	9,6
6	3,5	9,6
10	4,3	15

CQ4 02, 2 poles + PE connector inserts
Maximum current load derating diagram



Coding pins
CR Q02
(page 691)



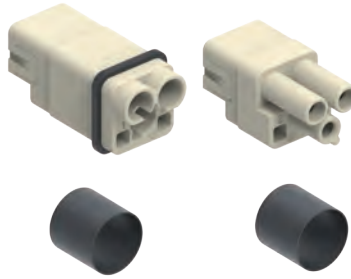
CQ4F/M 02 H 2 poles + ⊕ 40A - 830V

enclosures:
size "21.21" page:

Insulating type 339 - 348
 Metallic type 349 - 363
 W-TYPE for aggressive environments 512 - 518
 EMC 564 - 572
 IP68 628 - 631
 E-Xtreme® corrosion proof 538 - 539

- cannot be used in angled enclosures (IA/IAP/VA version)

inserts, crimp connections heat-shrinking tube



HIGHER VOLTAGE 830V

40A crimp contacts silver plated



description	part No.	part No.
-------------	----------	----------

without contacts (to be ordered separately), including PE female inserts for female contacts
male inserts for male contacts

CQ4F 02 H
CQ4M 02 H

40A female crimp contacts

1,5 mm ²	AWG 16
2,5 mm ²	AWG 14
4 mm ²	AWG 12
6 mm ²	AWG 10
10 mm ²	AWG 8

40A male crimp contacts

1,5 mm ²	AWG 16
2,5 mm ²	AWG 14
4 mm ²	AWG 12
6 mm ²	AWG 10
10 mm ²	AWG 8

CXFA 1.5
CXFA 2.5
CXFA 4.0
CXFA 6.0
CXFA 10

silver plated

CXMA 1.5
CXMA 2.5
CXMA 4.0
CXMA 6.0
CXMA 10

- characteristics according to EN 61984:

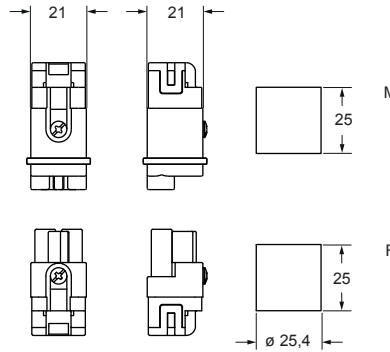
40A 830V 6kV 3

- cULus (UL for USA and Canada),

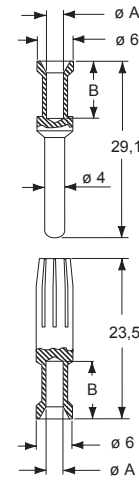
ERC certified

- rated voltage according to UL/CSA: 600V
- insulation resistance: ≥ 10 GΩ
- ambient temperature limit: -40 °C ... +125 °C
- made of self-extinguishing thermoplastic resin UL 94V-0
- mechanical life: ≥ 500 cycles
- contact resistance: ≤ 0,3 mΩ
- **it is recommended to crimp the contacts with crimping tools homologated by ILME** (please see the crimping tool section 40A contacts CXF and CXM series, on pages 708 - 741)
- for max. current load see the connector inserts derating diagram below; for more information see page 28

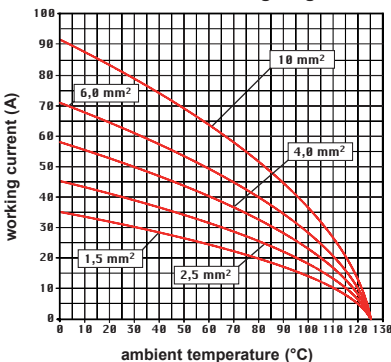
- wire diameter: up to 7,5 mm
conductor cross-sectional area: up to 10 mm²



contacts side (front view)



CQ4 02 H, 2 poles + PE connector inserts
Maximum current load derating diagram



Coding pins
CR Q02
(page 691)



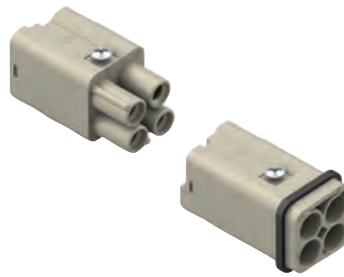
CXF and CXM contacts

conductor cross-sectional area (mm ²)	conductor slot ø A (mm)	conductor stripping length B (mm)
1,5	1,8	9
2,5	2,2	9
4	2,85	9,6
6	3,5	9,6
10	4,3	15

CQ4F/M 03 3 poles + ⊕ 40A - 400V

enclosures: size "21.21"	page:
Insulating type	339 - 348
Metallic type	349 - 363
W-TYPE for aggressive environments	512 - 518
EMC	564 - 572
IP68	628 - 631
E-Xtreme® corrosion proof	538 - 539

inserts, crimp connections



40A crimp contacts
silver plated



- cannot be used in angled enclosures (IA/IAP/VA version)

description	part No.	part No.
-------------	----------	----------

without contacts (to be ordered separately)
female inserts for female contacts *
male inserts for male contacts *

CQ4F 03
CQ4M 03

40A female crimp contacts

1,5 mm ²	AWG 16
2,5 mm ²	AWG 14
4 mm ²	AWG 12
6 mm ²	AWG 10
10 mm ²	AWG 8

CXFA 1.5
CXFA 2.5
CXFA 4.0
CXFA 6.0
CXFA 10

silver plated

40A male crimp contacts

1,5 mm ²	AWG 16
2,5 mm ²	AWG 14
4 mm ²	AWG 12
6 mm ²	AWG 10
10 mm ²	AWG 8

CXMA 1.5
CXMA 2.5
CXMA 4.0
CXMA 6.0
CXMA 10

* wire diameter: up to 7,5 mm
contact section: up to 10 mm²

- the female insert **CQ4F 03** is finger proof (IP2X or IPXXB) even if not coupled, while the male insert **CQ4M 03** in this circumstance is protected from access with the back of the hand (IP1X or IPXXA).

- characteristics according to EN 61984:

40A 400V 6kV 3

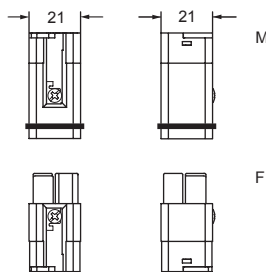
- cULus (UL for USA and Canada),

ERC certified

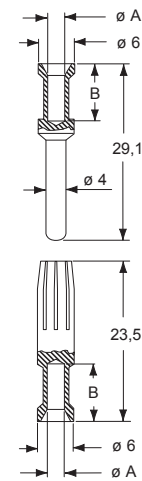
- insulation resistance: ≥ 10 GΩ
- ambient temperature limit: -40 °C ... +125 °C
- made of self-extinguishing thermoplastic resin UL 94V-0
- mechanical life: ≥ 500 cycles
- contact resistance: ≤ 0,3 mΩ

- **it is recommended to crimp the contacts with crimping tools homologated by ILME** (please see the crimping tool section 40A contacts CXF and CXM series, on pages 708 - 741)

- for max. current load see the connector inserts derating diagram below; for more information see page 28



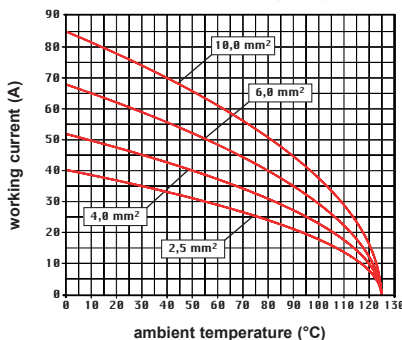
contacts side (front view)



CXF and CXM contacts

conductor section mm ²	conductor slot ø A (mm)	conductors stripping length B (mm)
1,5	1,8	9
2,5	2,2	9
4	2,85	9,6
6	3,5	9,6
10	4,3	15

CQ4 03, 3 poles + PE connector inserts
Maximum current load derating diagram



Coding pins
CR Q03
(4 possible positions)
(page 692)





CQ 5 poles + ⊕ 16A - 230/400V

enclosures: size "21.21"	page:
Insulating type	339 - 348
Metallic type	349 - 363
W-TYPE for aggressive environments	512 - 518
EMC	564 - 572
IP68	628 - 631
E-Xtreme® corrosion proof	538 - 539

- it is recommended to crimp the contacts with crimping tools homologated by ILME (please see the crimping tool section 16A contacts, CCF, CCM and CC...AN series on pages 708 - 741)
- inserts and enclosures for applications with temperatures up to 180 °C, available on request
- can also be used partially fitted with 4 mm² section contacts

inserts, crimp connections



16A crimp contacts standard or for advanced opening silver and gold plated



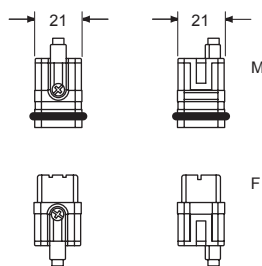
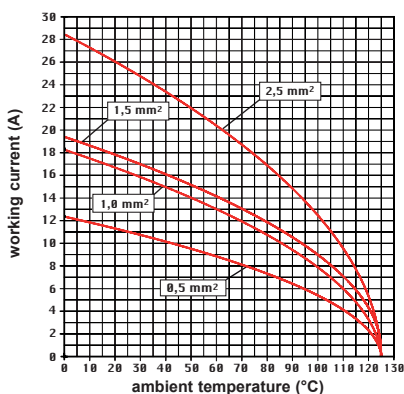
STANDARD

ADVANCED OPENING

description	part No.	part No.	part No.
without contacts (to be ordered separately)			
female inserts for female contacts	CQF 05		
male inserts for male contacts	CQM 05		
16A female contacts			
0,14-0,37 mm² AWG 26-22 one groove		CCFA 0.3	CCFD 0.3
0,5 mm² AWG 20 with no grooves		CCFA 0.5	CCFD 0.5
0,75 mm² AWG 18 one groove (back side)		CCFA 0.7	CCFD 0.7
1 mm² AWG 18 one groove		CCFA 1.0	CCFD 1.0
1,5 mm² AWG 16 two grooves		CCFA 1.5	CCFD 1.5
2,5 mm² AWG 14 three grooves		CCFA 2.5	CCFD 2.5
3 mm² AWG 12 one wide groove		CCFA 3.0	CCFD 3.0
4 mm² AWG 12 with no grooves		CCFA 4.0	CCFD 4.0
16A male contacts			
0,14-0,37 mm² AWG 26-22 one groove		CCMA 0.3	CCMD 0.3
0,5 mm² AWG 20 with no grooves		CCMA 0.5	CCMD 0.5
0,75 mm² AWG 18 one groove (back side)		CCMA 0.7	CCMD 0.7
1 mm² AWG 18 one groove		CCMA 1.0	CCMD 1.0
1,5 mm² AWG 16 two grooves		CCMA 1.5	CCMD 1.5
2,5 mm² AWG 14 three grooves		CCMA 2.5	CCMD 2.5
3 mm² AWG 12 one wide groove		CCMA 3.0	CCMD 3.0
4 mm² AWG 12 with no grooves		CCMA 4.0	CCMD 4.0
16A male crimp contacts for advanced opening			
0,5 mm² AWG 20 with no grooves		CC 0.5 AN	* for basic or high thickness gold plating, please refer to page 675
0,75 mm² AWG 18 one groove (back side)		CC 0.7 AN	
1 mm² AWG 18 one groove		CC 1.0 AN	
1,5 mm² AWG 16 two grooves		CC 1.5 AN	
2,5 mm² AWG 14 three grooves		CC 2.5 AN	

- characteristics according to EN 61984:
16A 230/400V 4kV 3
16A 320/500V 4kV 2
- cULus (UL for USA and Canada), certified
- rated voltage according to UL/CSA: 600V
- insulation resistance: ≥ 10 GΩ
- ambient temperature limit: -40 °C ... +125 °C
- made of self-extinguishing thermoplastic resin UL 94V-0
- mechanical life: ≥ 500 cycles
- contact resistance: ≤ 1 mΩ
- for max. current load see the connector inserts derating diagram below; for more information see page 28

CQ 05 poles connector inserts
Maximum current load derating diagram



contacts side (front view)

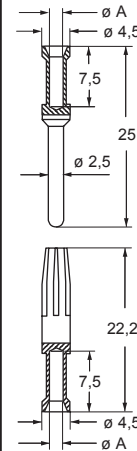


Note:
PE screw connection for unprepared wires only

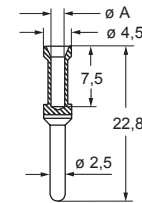
Coding pins CR CPQ
(page 689)



CCF and CCM



CC...AN



CCF, CCM and CC...AN contacts

conductor section mm²	conductor slot ø A (mm)	conductors stripping length (mm)
0,14-0,37	0,9	7,5
0,5	1,1	7,5
0,75	1,3	7,5
1,0	1,45	7,5
1,5	1,8	7,5
2,5	2,2	7,5
3	2,55	7,5
4	2,85	7,5

CQ 7 poles + ⊕ 10A - 400V

enclosures: size "21.21"	page:
Insulating type	339 - 348
Metallic type	349 - 363
W-TYPE for aggressive environments	512 - 518
EMC	564 - 572
IP68	628 - 631
E-Xtreme® corrosion proof	538 - 539

inserts, crimp connections

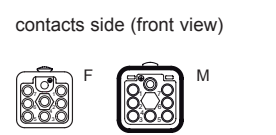
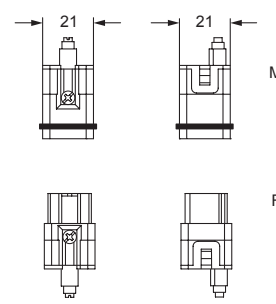


10A crimp contacts silver and gold plated



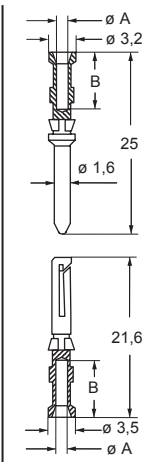
description	part No.	part No.	part No.
without contacts (to be ordered separately)			
female inserts for female contacts	CQF 07		
male inserts for male contacts	CQM 07		
10A female contacts			
0,14-0,37 mm ² AWG 26-22 identification No. 1		CDFA 0.3	CDFD 0.3
0,5 mm ² AWG 20 identification No. 2		CDFA 0.5	CDFD 0.5
0,75 mm ² AWG 18 identification No. ②		CDFA 0.7	CDFD 0.7
1 mm ² AWG 18 identification No. 3		CDFA 1.0	CDFD 1.0
1,5 mm ² AWG 16 identification No. 4		CDFA 1.5	CDFD 1.5
2,5 mm ² AWG 14 identification No. 5		CDFA 2.5	CDFD 2.5
10A male contacts			
0,14-0,37 mm ² AWG 26-22 identification No. 1		CDMA 0.3	CDMD 0.3
0,5 mm ² AWG 20 identification No. 2		CDMA 0.5	CDMD 0.5
0,75 mm ² AWG 18 identification No. ②		CDMA 0.7	CDMD 0.7
1 mm ² AWG 18 identification No. 3		CDMA 1.0	CDMD 1.0
1,5 mm ² AWG 16 identification No. 4		CDMA 1.5	CDMD 1.5
2,5 mm ² AWG 14 identification No. 5		CDMA 2.5	CDMD 2.5

- characteristics according to EN 61984:
- 10A 400V 6kV 3**
- cULus (UL for USA and Canada), DNV-GL, BUREAU VERITAS
- ERC** certified
- rated voltage according to UL/CSA: 600V
- insulation resistance: ≥ 10 GΩ
- ambient temperature limit: -40 °C ... +125 °C
- made of self-extinguishing thermoplastic resin UL 94V-0
- mechanical life: ≥ 500 cycles
- contact resistance: ≤ 3 mΩ
- inserts already supplied with stainless steel fixing screw with gasket, which ensures IP66/IP67/IP69 degree of protection
- first-make last-break screw-type PE contact
- **it is recommended to crimp the contacts with crimping tools homologated by ILME** (please see the crimping tool section 10A contacts, CDF and CDM series on pages 708 - 741)
- for max. current load see the connector inserts derating diagram below; for more information see page 28



Note:
PE screw connection for unprepared wires only

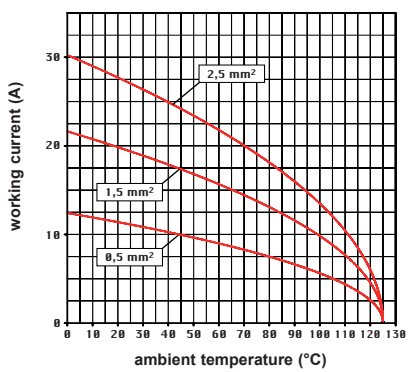
☑ The **CR QF07** and **CR QM07** coding pins (to be ordered separately), allow the user to create 6 different combinations, according to the diagram shown on **page 690**



CDF and CDM contacts		
conductor section mm ²	conductor slot ø A (mm)	conductors stripping length B (mm)
0,14-0,37	0,9	8
0,5	1,1	8
0,75	1,3	8
1,0	1,45	8
1,5	1,8	8
2,5	2,2	6

✦ for basic or high thickness gold plating, please refer to page 674

CQ 07 poles connector inserts
Maximum current load derating diagram



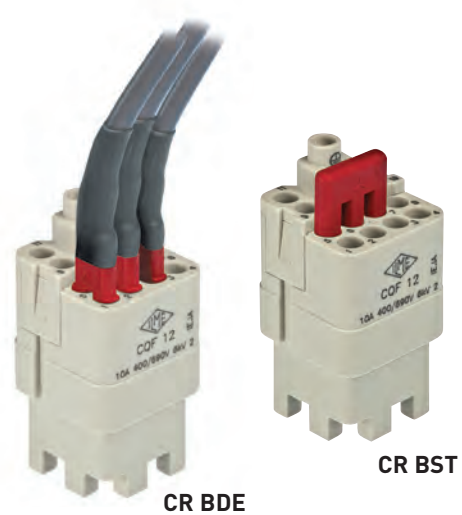
CQ 12 poles + ⊕ series

TECHNICAL FEATURES

Compactness meets performance

Compact solution for high density needs.

Reliable, 16 coding possibilities, perfect for small motors with bridges for star/delta configuration.



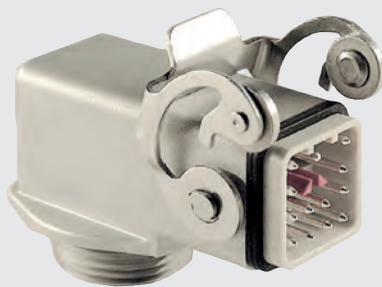
CR BDE

CR BST


Bridges for delta or star connection
from page 694, 695

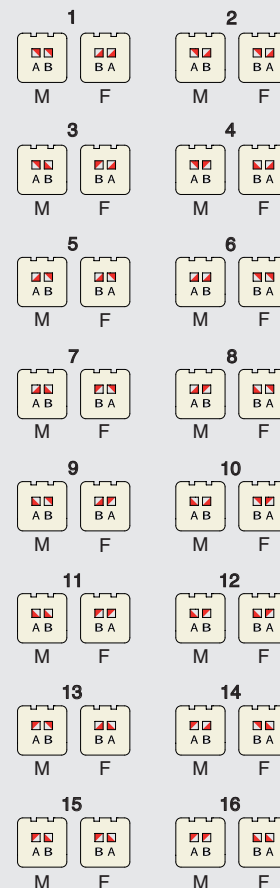
Coding positions for CQ 12 connector

See diagram to the right



Legend:

-  (A B) CQ 12 coding pin
- M = male insert
- F = female insert



CQ 12 poles + ⊕ 10A - 400V

enclosures: size "21.21"	page:
Insulating type	339 - 348
Metallic type	349 - 363
W-TYPE for aggressive environments	512 - 518
EMC	564 - 572
IP68	628 - 631
E-Xtreme® corrosion proof	538 - 539



ISO 23570-3 standard and
DESINA, specification
compliant

inserts, crimp connections



10A crimp contacts silver and gold plated



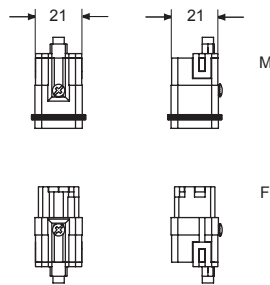
description	part No.	part No.	part No.
without contacts (to be ordered separately)			
female inserts for female contacts	CQF 12		
male inserts for male contacts	CQM 12		
10A female contacts			
0,14-0,37 mm ² AWG 26-22 identification No. 1		CDFA 0.3	CDFD 0.3
0,5 mm ² AWG 20 identification No. 2		CDFA 0.5	CDFD 0.5
0,75 mm ² AWG 18 identification No. ②		CDFA 0.7	CDFD 0.7
1 mm ² AWG 18 identification No. 3		CDFA 1.0	CDFD 1.0
1,5 mm ² AWG 16 identification No. 4		CDFA 1.5	CDFD 1.5
2,5 mm ² AWG 14 identification No. 5		CDFA 2.5	CDFD 2.5
10A male contacts			
0,14-0,37 mm ² AWG 26-22 identification No. 1		CDMA 0.3	CDMD 0.3
0,5 mm ² AWG 20 identification No. 2		CDMA 0.5	CDMD 0.5
0,75 mm ² AWG 18 identification No. ②		CDMA 0.7	CDMD 0.7
1 mm ² AWG 18 identification No. 3		CDMA 1.0	CDMD 1.0
1,5 mm ² AWG 16 identification No. 4		CDMA 1.5	CDMD 1.5
2,5 mm ² AWG 14 identification No. 5		CDMA 2.5	CDMD 2.5

- characteristics according to EN 61984:

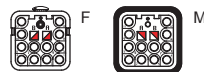
10A 400V 6kV 3
10A 400/690V 6kV 2

- cULus (UL for USA and Canada),
BUREAU VERITAS EAC certified

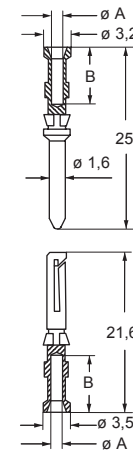
- rated voltage according to UL/CSA: 600V
- insulation resistance: ≥ 10 GΩ
- ambient temperature limit: -40 °C ... +125 °C
- made of self-extinguishing thermoplastic resin UL 94V-0
- mechanical life: ≥ 500 cycles
- contact resistance: ≤ 3 mΩ
- inserts already supplied with stainless steel fixing screw with gasket, which ensures IP66/IP67/IP69 degree of protection
- **it is recommended to crimp the contacts with crimping tools homologated by ILME** (please see the crimping tool section 10A contacts, CDF and CDM series on pages 708 - 741)
- for max. current load see the connector inserts derating diagram below; for more information see page 28



contacts side (front view)



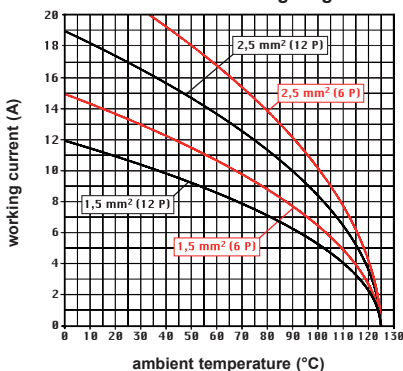
Note:
PE screw connection for unprepared wires only



CDF and CDM contacts

conductor section mm ²	conductor slot ø A (mm)	conductors stripping length B (mm)
0,14-0,37	0,9	8
0,5	1,1	8
0,75	1,3	8
1,0	1,45	8
1,5	1,8	8
2,5	2,2	6

CQ 12 poles connector inserts
Maximum current load derating diagram



The **CR Q12** coding pins (to be ordered separately), allow the user to create 16 different combinations, according to the diagram shown on **page 689**

† for basic or high thickness gold plating, please refer to page 674

CQ 21 poles 6,5A - 50V ac / 120V dc

enclosures:
size "21.21"

page:

Insulating type	339 - 348
Metallic type	349 - 363
W-TYPE for aggressive environments	512 - 518
EMC	564 - 572
IP68	628 - 631
E-Xtreme® corrosion proof	538 - 539

inserts, crimp connections



CI crimp contacts silver and gold plated



description

part No.

part No.

part No.

without contacts (to be ordered separately)
female inserts for female contacts
male inserts for male contacts

CQF 21
CQM 21

CI female crimp contacts

0,08-0,21 mm ²	AWG 28-24
0,13-0,33 mm ²	AWG 26-22
0,33-0,52 mm ²	AWG 22-20

CIFA 0.2
CIFA 0.3
CIFA 0.5

silver plated

CIFD 0.2
CIFD 0.3
CIFD 0.5

gold plated

CI male crimp contacts

0,08-0,21 mm ²	AWG 28-24
0,13-0,33 mm ²	AWG 26-22
0,33-0,52 mm ²	AWG 22-20

CIMA 0.2
CIMA 0.3
CIMA 0.5

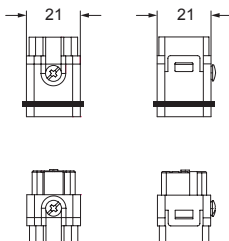
CIMD 0.2
CIMD 0.3
CIMD 0.5

- characteristics according to EN 61984:

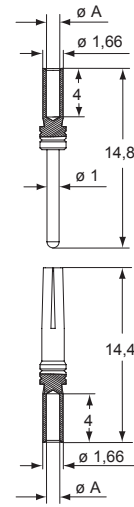
6,5A 50V ac / 120V dc 0,8kV 3

- (UL for USA and Canada), certified

- rated voltage according to UL/CSA: 250V
- insulation resistance: ≥ 10 GΩ
- ambient temperature limit: -40 °C ... +125 °C
- made of self-extinguishing thermoplastic resin UL 94V-0
- mechanical life: ≥ 500 cycles
- contact resistance: ≤ 4 mΩ
- seat of contact #9 on both inserts set forward to obtain pre-leading contact (e.g. for FE functional earth)
- for crimp contacts CI series use, see page 716 - 719
- **CIPZ D** crimping tool
- **CITP D** turret head
- **CIES** insertion / removal tool
- for max. current load see the connector inserts derating diagram below; for more information see page 28



contacts side (front view)

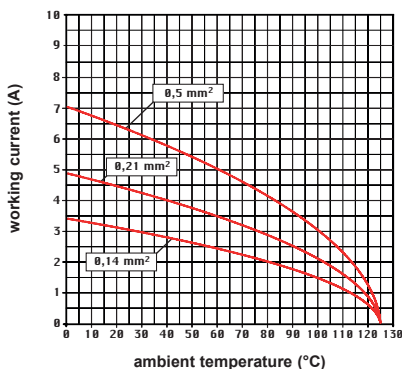


CIF and CIM contacts

conductor section mm ²	conductor slot ø A (mm)	conductors stripping length (mm)
0,08-0,21	0,64	4
0,13-0,33	0,90	4
0,33-0,52	1,12	4

max insulation diameter: 1,7 mm

CQ 21 poles connector inserts
Maximum current load derating diagram



CQ 4 poles (40A - 400/690V) + 2 poles (10A - 250V) + ⊕

enclosures:
size "32.13"

page:

insulating type
EMC

365 - 367
573 - 574

ISO 23570-3 standard and
DESINA specification
compliant



inserts, crimp connections



40A and 10A crimp contacts silver and gold plated



description	part No.	part No.	part No.
-------------	----------	----------	----------

without contacts (to be ordered separately)
female inserts for female contacts
male inserts for male contacts

CQF 04/2
CQM 04/2

40A female crimp contacts
1,5 mm² AWG 16
2,5 mm² AWG 14
4 mm² AWG 12
6 mm² AWG 10

40A male crimp contacts
1,5 mm² AWG 16
2,5 mm² AWG 14
4 mm² AWG 12
6 mm² AWG 10

10A female contacts
0,14-0,37 mm² AWG 26-22 identification No. 1
0,5 mm² AWG 20 identification No. 2
0,75 mm² AWG 18 identification No. ②
1 mm² AWG 18 identification No. 3
1,5 mm² AWG 16 identification No. 4
2,5 mm² AWG 14 identification No. 5

10A male contacts
0,14-0,37 mm² AWG 26-22 identification No. 1
0,5 mm² AWG 20 identification No. 2
0,75 mm² AWG 18 identification No. ②
1 mm² AWG 18 identification No. 3
1,5 mm² AWG 16 identification No. 4
2,5 mm² AWG 14 identification No. 5

CXFA 1.5
CXFA 2.5
CXFA 4.0
CXFA 6.0

silver plated

CXMA 1.5
CXMA 2.5
CXMA 4.0
CXMA 6.0

+ for basic or high
thickness gold
plating, please refer
to page 674

CDFA 0.3
CDFA 0.5
CDFA 0.7
CDFA 1.0
CDFA 1.5
CDFA 2.5

CDFD 0.3
CDFD 0.5
CDFD 0.7
CDFD 1.0
CDFD 1.5
CDFD 2.5

gold plated+*

CDMA 0.3
CDMA 0.5
CDMA 0.7
CDMA 1.0
CDMA 1.5
CDMA 2.5

CDMD 0.3
CDMD 0.5
CDMD 0.7
CDMD 1.0
CDMD 1.5
CDMD 2.5

- characteristics according to EN 61984:

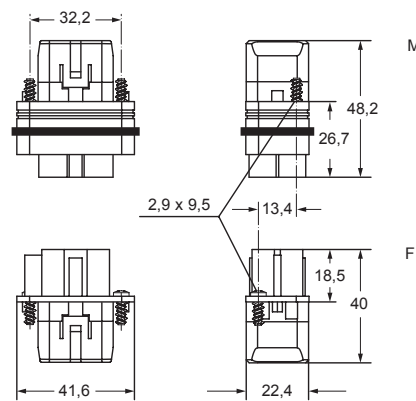
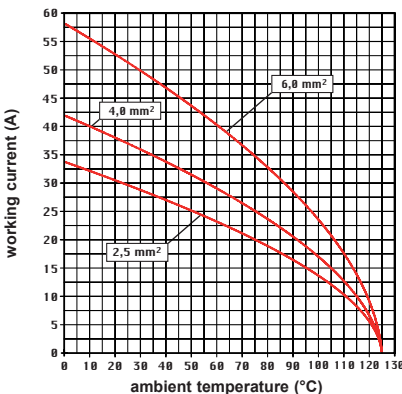
4 poles 40A 400/690V 6kV 3
2 poles 10A 250V 4kV 3

- cULus (UL for USA and Canada),

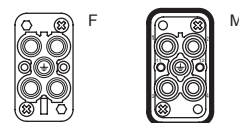
- certified

- rated voltage according to UL/CSA: 600V
- insulation resistance: ≥ 10 GΩ
- ambient temperature limit: -40 °C ... +125 °C
- made of self-extinguishing thermoplastic resin UL 94V-0
- mechanical life: ≥ 500 cycles
- contact resistance: ≤ 0,3 mΩ (4 poles), ≤ 3 mΩ (2 poles)
- for max. current load see the connector inserts derating diagram below; for more information see page 28

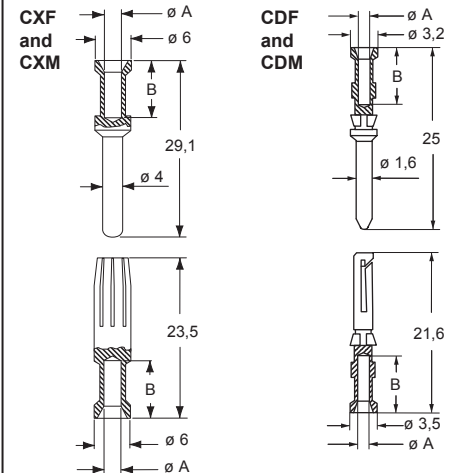
CQ 04/2 power poles connector inserts
Maximum current load derating diagram



contacts side (front view)



- each insert supplied with 2 fixing screws, self-tapping, zinc plated steel Ø2,9x9,5 mm, Ph1
- it is recommended to crimp the contacts with crimping tools homologated by ILME (please see the crimping tool section 40A contacts, CXF, CXM series and 10A contacts CDF, CDM series on pages 708 - 741)



CXF and CXM contacts

conductor section mm ²	conductor slot Ø A (mm)	conductors stripping length B (mm)
1,5	1,8	9
2,5	2,2	9
4	2,85	9,6
6	3,5	9,6

CDF and CDM contacts

0,14-0,37	0,9	8
0,5	1,1	8
0,75	1,3	8
1,0	1,45	8
1,5	1,8	8
2,5	2,2	6

CQ 8 poles + ⊕ 16A - 500V

enclosures:
size "32.13"

page:

insulating type
EMC

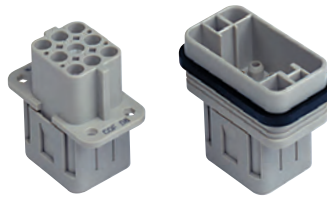
365 - 367
573 - 574

- can also be used partially fitted with 4 mm² section contacts

ISO 23570-3 standard and
DESINA. specification
compliant



inserts, crimp connections



16A crimp contacts standard or for advanced opening silver and gold plated



STANDARD



ADVANCED OPENING

description	part No.	part No.	part No.
without contacts (to be ordered separately)			
female inserts for female contacts	CQF 08		
male inserts for male contacts	CQM 08		
16A female contacts			
0,14-0,37 mm ² AWG 26-22 one groove		CCFA 0.3	CCFD 0.3
0,5 mm ² AWG 20 with no grooves		CCFA 0.5	CCFD 0.5
0,75 mm ² AWG 18 one groove (back side)		CCFA 0.7	CCFD 0.7
1 mm ² AWG 18 one groove		CCFA 1.0	CCFD 1.0
1,5 mm ² AWG 16 two grooves		CCFA 1.5	CCFD 1.5
2,5 mm ² AWG 14 three grooves		CCFA 2.5	CCFD 2.5
3 mm ² AWG 12 one wide groove		CCFA 3.0	CCFD 3.0
4 mm ² AWG 12 with no grooves		CCFA 4.0	CCFD 4.0
16A male contacts			
0,14-0,37 mm ² AWG 26-22 one groove		CCMA 0.3	CCMD 0.3
0,5 mm ² AWG 20 with no grooves		CCMA 0.5	CCMD 0.5
0,75 mm ² AWG 18 one groove (back side)		CCMA 0.7	CCMD 0.7
1 mm ² AWG 18 one groove		CCMA 1.0	CCMD 1.0
1,5 mm ² AWG 16 two grooves		CCMA 1.5	CCMD 1.5
2,5 mm ² AWG 14 three grooves		CCMA 2.5	CCMD 2.5
3 mm ² AWG 12 one wide groove		CCMA 3.0	CCMD 3.0
4 mm ² AWG 12 with no grooves		CCMA 4.0	CCMD 4.0
16A male crimp contacts for advanced opening			
0,5 mm ² AWG 20 with no grooves		CC 0.5 AN	* for basic or high thickness gold plating, please refer to page 675
0,75 mm ² AWG 18 one groove (back side)		CC 0.7 AN	
1 mm ² AWG 18 one groove		CC 1.0 AN	
1,5 mm ² AWG 16 two grooves		CC 1.5 AN	
2,5 mm ² AWG 14 three grooves		CC 2.5 AN	

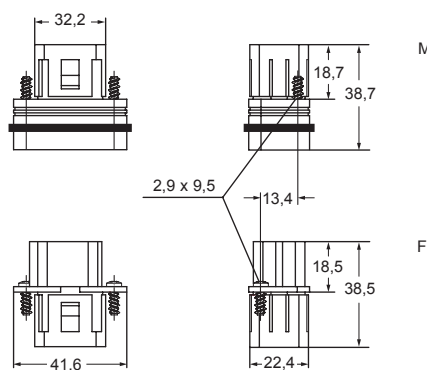
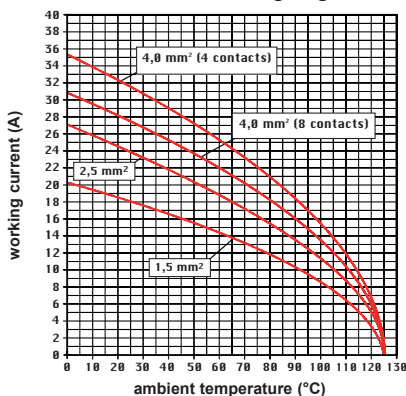
- characteristics according to EN 61984:

16A 500V 6kV 3
16A 400/690V 8kV 2

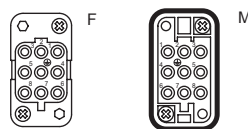
- cULus (UL for USA and Canada),

- certified
- rated voltage according to UL/CSA: 600V
- insulation resistance: ≥ 10 GΩ
- ambient temperature limit: -40 °C ... +125 °C
- made of self-extinguishing thermoplastic resin UL 94V-0
- mechanical life: ≥ 500 cycles
- contact resistance: ≤ 3 mΩ
- for max. current load see the connector inserts derating diagram below; for more information see page 28

CQ 08 poles connector inserts
Maximum current load derating diagram

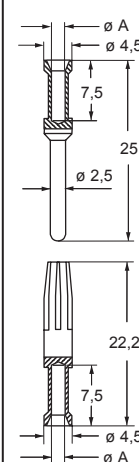


contacts side (front view)

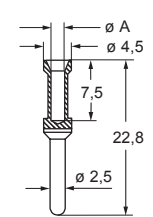


- each insert supplied with 2 fixing screws, self-tapping, zinc plated steel Ø2,9x9,5 mm, Ph1
- it is recommended to crimp the contacts with crimping tools homologated by ILME (please see the crimping tool section 16A contacts, CCF, CCM and CC...AN series on pages 708 - 741)

CCF and CCM



CC...AN



CCF, CCM and CC...AN contacts

conductor section mm ²	conductor slot Ø A (mm)	conductors stripping length (mm)
0,14-0,37	0,9	7,5
0,5	1,1	7,5
0,75	1,3	7,5
1,0	1,45	7,5
1,5	1,8	7,5
2,5	2,2	7,5
3	2,55	7,5
4	2,85	7,5

CQ 17 poles + ⊕ 10A - 160V

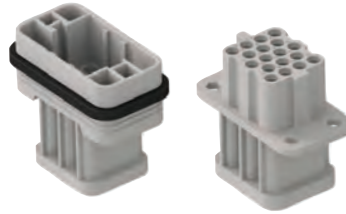
enclosures:
size "32.13"

page:

insulating type
EMC

365 - 367
573 - 574

inserts, crimp connections



10A crimp contacts silver and gold plated



description	part No.	part No.	part No.
without contacts (to be ordered separately)			
female inserts for female contacts	CQF 17		
male inserts for male contacts	CQM 17		
10A female contacts			
0,14-0,37 mm ² AWG 26-22 identification No. 1		CDFA 0.3	CDFD 0.3
0,5 mm ² AWG 20 identification No. 2		CDFA 0.5	CDFD 0.5
0,75 mm ² AWG 18 identification No. ②		CDFA 0.7	CDFD 0.7
1 mm ² AWG 18 identification No. 3		CDFA 1.0	CDFD 1.0
1,5 mm ² AWG 16 identification No. 4		CDFA 1.5	CDFD 1.5
2,5 mm ² AWG 14 identification No. 5		CDFA 2.5	CDFD 2.5
		silver plated	gold plated ⁺
10A male contacts			
0,14-0,37 mm ² AWG 26-22 identification No. 1		CDMA 0.3	CDMD 0.3
0,5 mm ² AWG 20 identification No. 2		CDMA 0.5	CDMD 0.5
0,75 mm ² AWG 18 identification No. ②		CDMA 0.7	CDMD 0.7
1 mm ² AWG 18 identification No. 3		CDMA 1.0	CDMD 1.0
1,5 mm ² AWG 16 identification No. 4		CDMA 1.5	CDMD 1.5
2,5 mm ² AWG 14 identification No. 5		CDMA 2.5	CDMD 2.5

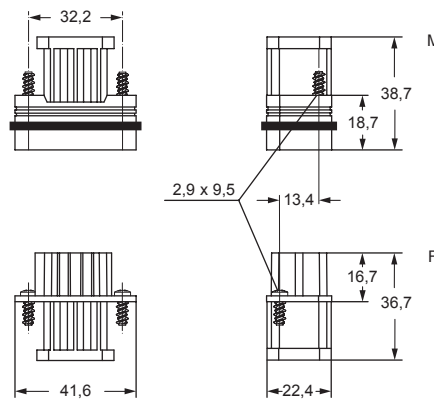
- characteristics according to EN 61984:

10A 160V 2,5kV 3
10A 250V 4kV 2

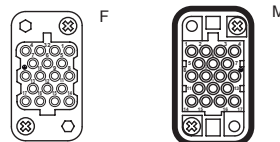
- cULus (UL for USA and Canada), DNV-GL BUREAU VERITAS

ERC certified

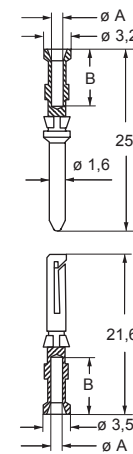
- rated voltage according to UL/CSA: 250V
- insulation resistance: ≥ 10 GΩ
- ambient temperature limit: -40 °C ... +125 °C
- made of self-extinguishing thermoplastic resin UL 94V-0
- mechanical life: ≥ 500 cycles
- contact resistance: ≤ 3 mΩ
- seat of PE contact on female insert set forward to obtain pre-leading PE
- each insert supplied with 2 fixing screws, self-tapping, zinc plated steel Ø2,9x9,5 mm, Ph1
- **it is recommended to crimp the contacts with crimping tools homologated by ILME** (please see the crimping tool section 10A contacts, CDF and CDM series on pages 708 - 741)
- for max. current load see the connector inserts derating diagram below; for more information see page 28



contacts side (front view)



CR CP coding pin with loss of one contact (page 689)

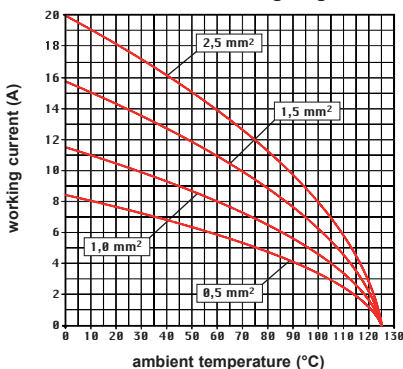


CDF and CDM contacts

conductor section mm ²	conductor slot ø A (mm)	conductors stripping length B (mm)
0,14-0,37	0,9	8
0,5	1,1	8
0,75	1,3	8
1,0	1,45	8
1,5	1,8	8
2,5	2,2	6

⁺ for basic or high thickness gold plating, please refer to page 674

CQ 17 poles connector inserts
Maximum current load derating diagram



CX 8 poles (16 A – 230/400 V) + 24 poles (10 A – 160 V) + ⊕

enclosures: size "57.27"	page:
C-TYPE IP65 or IP66/IP69	393 - 401
C7 IP67, two levers	438
V-TYPE IP65 or IP66/IP69, single lever	448 - 453
BIG hoods	468 - 469
T-TYPE IP65 insulating	482 - 483
T-TYPE / W IP66/IP69 insulating	490
HYGIENIC T-TYPE / H IP66/IP69	502
HYGIENIC T-TYPE / C IP66/IP69, -50 °C	507
W-TYPE for aggressive environments	522
E-Xtreme® corrosion proof	532 - 533, 543, 552 - 553
EMC	579
Central lever	606 - 608
LS-TYPE	620 - 621
IP68	636 - 639
panel supports: COB	page: 652 - 653

inserts, crimp connections

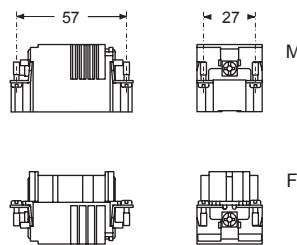


description	part No.
-------------	----------

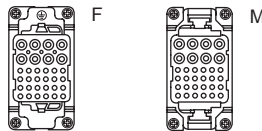
without contacts (to be ordered separately)
female inserts for female contacts
male inserts for male contacts

CXF 8/24
CXM 8/24

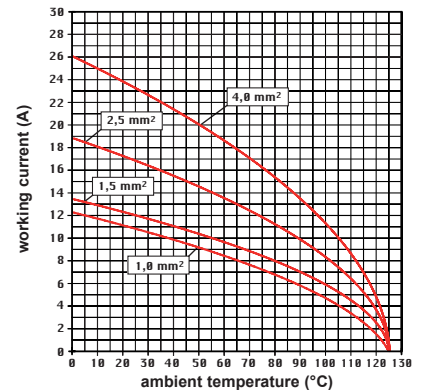
- characteristics according to EN 61984:
16 A 230/400 V 4 kV 3
16 A 400 V 4 kV 2
10 A 160 V 2,5 kV 3
10 A 250 V 4 kV 2
- certified
- rated voltage according to UL/CSA: 600 V
- insulation resistance: ≥ 10 GΩ
- ambient temperature limit: -40 °C ... +125 °C
- made of self-extinguishing thermoplastic resin UL 94V-0
- mechanical life: ≥ 500 cycles
- contact resistance:
 ≤ 1 mΩ (8 poles)
 ≤ 3 mΩ (24 poles)
- **it is recommended to crimp the contacts with crimping tools homologated by ILME**
 (please see the crimping tool section 16 A contacts, CCF, CCM, CC...AN series and 10 A contacts CDF, CDM series on pages 708 - 741)
- PCBs interface, see article CIF 2.4 (10 A contacts)
- for max. current load see the connector inserts derating diagrams on the side; for more information see page 28



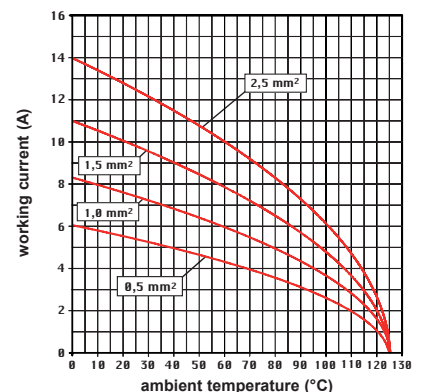
contacts side (front view)



CX 8/24 power poles connector inserts Maximum current load derating diagram



CX 8/24 auxiliary poles connector inserts Maximum current load derating diagram

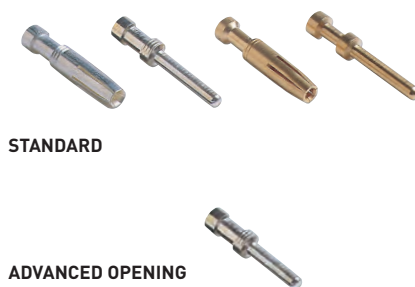


Note: for connector with power poles and auxiliary poles simultaneously loaded in the combinations

power poles	auxiliary poles
4,0 mm ²	2,5 mm ²
2,5 mm ²	1,5 mm ²
1,5 mm ²	1,0 mm ²
1,0 mm ²	0,5 mm ²

with power / auxiliary current ratios = 1,6 / 1

**16 A crimp contacts
standard or for advanced opening
silver and gold plated**



STANDARD

ADVANCED OPENING

**10 A crimp contacts
silver and gold plated**



description	part No.	part No.	part No.	part No.
16 A female contacts				
0,14-0,37 mm ²	AWG 26-22	one groove	CCFA 0.3	CCFD 0.3
0,5 mm ²	AWG 20	with no grooves	CCFA 0.5	CCFD 0.5
0,75 mm ²	AWG 18	one groove (back side)	CCFA 0.7	CCFD 0.7
1 mm ²	AWG 18	one groove	CCFA 1.0	CCFD 1.0
1,5 mm ²	AWG 16	two grooves	CCFA 1.5	CCFD 1.5
2,5 mm ²	AWG 14	three grooves	CCFA 2.5	CCFD 2.5
3 mm ²	AWG 12	one wide groove	CCFA 3.0	CCFD 3.0
4 mm ²	AWG 12	with no grooves	CCFA 4.0	CCFD 4.0
16 A male contacts				
0,14-0,37 mm ²	AWG 26-22	one groove	CCMA 0.3	CCMD 0.3
0,5 mm ²	AWG 20	with no grooves	CCMA 0.5	CCMD 0.5
0,75 mm ²	AWG 18	one groove (back side)	CCMA 0.7	CCMD 0.7
1 mm ²	AWG 18	one groove	CCMA 1.0	CCMD 1.0
1,5 mm ²	AWG 16	two grooves	CCMA 1.5	CCMD 1.5
2,5 mm ²	AWG 14	three grooves	CCMA 2.5	CCMD 2.5
3 mm ²	AWG 12	one wide groove	CCMA 3.0	CCMD 3.0
4 mm ²	AWG 12	with no grooves	CCMA 4.0	CCMD 4.0
16 A male crimp contacts for advanced opening				
0,5 mm ²	AWG 20	with no grooves	CC 0.5 AN	
0,75 mm ²	AWG 18	one groove (back side)	CC 0.7 AN	
1 mm ²	AWG 18	one groove	CC 1.0 AN	
1,5 mm ²	AWG 16	two grooves	CC 1.5 AN	
2,5 mm ²	AWG 14	three grooves	CC 2.5 AN	
10 A female contacts				
0,14-0,37 mm ²	AWG 26-22	identification No. 1	CDFA 0.3	CDFD 0.3
0,5 mm ²	AWG 20	identification No. 2	CDFA 0.5	CDFD 0.5
0,75 mm ²	AWG 18	identification No. ②	CDFA 0.7	CDFD 0.7
1 mm ²	AWG 18	identification No. 3	CDFA 1.0	CDFD 1.0
1,5 mm ²	AWG 16	identification No. 4	CDFA 1.5	CDFD 1.5
2,5 mm ²	AWG 14	identification No. 5	CDFA 2.5	CDFD 2.5
10 A male contacts				
0,14-0,37 mm ²	AWG 26-22	identification No. 1	CDMA 0.3	CDMD 0.3
0,5 mm ²	AWG 20	identification No. 2	CDMA 0.5	CDMD 0.5
0,75 mm ²	AWG 18	identification No. ②	CDMA 0.7	CDMD 0.7
1 mm ²	AWG 18	identification No. 3	CDMA 1.0	CDMD 1.0
1,5 mm ²	AWG 16	identification No. 4	CDMA 1.5	CDMD 1.5
2,5 mm ²	AWG 14	identification No. 5	CDMA 2.5	CDMD 2.5

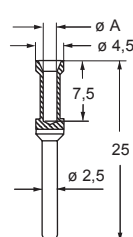
CCF, CCM and CC...AN contacts

conductor section mm ²	conductor slot $\varnothing A$ (mm)	conductors stripping length (mm)
0,14-0,37	0,9	7,5
0,5	1,1	7,5
0,75	1,3	7,5
1,0	1,45	7,5
1,5	1,8	7,5
2,5	2,2	7,5
3	2,55	7,5
4	2,85	7,5

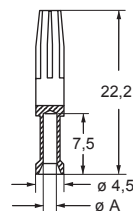
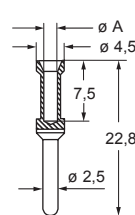
CDF and CDM contacts

conductor section mm ²	conductor slot $\varnothing A$ (mm)	conductors stripping length B (mm)
0,14-0,37	0,9	8
0,5	1,1	8
0,75	1,3	8
1,0	1,45	8
1,5	1,8	8
2,5	2,2	6

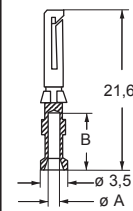
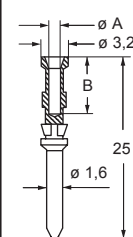
CCF and CCM



CC...AN



CDF and CDM



* for basic or high thickness gold plating, please refer to page 675

* for basic or high thickness gold plating, please refer to page 674

CX 6/12

TECHNICAL FEATURES

This combined connector, in addition to the traditional lateral protective earth contact with screw connection, is provided by contact seats for:

- ▶ 6 **CX** series crimp contacts up to the maximum size 10 for working current up to **40 A** and rated voltage up to **690 V**, and
- ▶ 12 **CD** series crimp contacts for working current up to **10 A** and rated voltage up to **230/400V**.

The removable crimp contacts of the **CX** series are held by resilient elements of the connector insert contact holder, while the removable crimp contacts of the **CD** series are equipped with their own retention means.

Compared to the **CX 6/36** combined connector of the same size "77.27" (see page 198) on the 6 power poles it allows the use of wires

with a rated cross-sectional area (CSA) up to 10 mm² / 8 AWG whereas the CX 6/36 on the same 6 power poles is limited to size 6.0 for conductors up to 6 mm² / 10 AWG rated CSA.

The lower number of auxiliary contacts (12 instead of 36) of this connector insert, is largely rewarded by the fact that these contacts can be used for voltages up to 230/400 V, hence also for motors of non-negligible power, while in the CX 6/36 connector due to their higher density, the auxiliary contacts (of the same CD series) are limited to use at 160 V.

The presence of 230/400 V rated auxiliaries therefore suggests for these 12 contacts the possible use also in drives of up to 4 three-phase motors for the control of e.g. 4 lower power axes, while the two high power axes can be served by the 6 power poles of this connector.

SUM-UP

- ☑ **Crimp connection**
- ☑ **Great resistance to strong vibrations**
- ☑ **For wires: up to 10 mm² (AWG 8)**
- ☑ **Auxiliary crimp contacts: silver or gold plated**

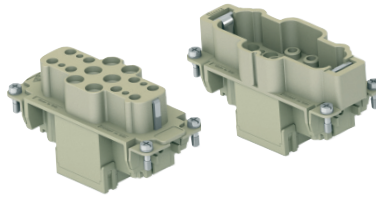


Inserts series		CX 6/12	
No. of poles	main contact	6 + ⊕ (40 A)	
	auxiliary contacts	12 (10 A)	
rated current		40 A	10 A
EN 61984 pollution degree 3	rated voltage	690 V	230 V/400 V
	rated impulse withstand voltage	8 kV	4 kV
	pollution degree	3	3
contact resistance		≤ 0,3 mΩ (40 A) ≤ 1 mΩ (16 A)	
insulation resistance		≥ 10 GΩ	
ambient temperature limit (°C)	min	-40 °C	
	max	+125 °C	
degree of protection	with enclosures (according to version)	IP65, IP66/IP69, IP66/IP67/IP69, IP66/IP68/IP69	
	without enclosures (in mated condition)	IP20 (IPXXB)	
conductor connections		crimp	
conductor cross-section	mm ²	1,5 10	
	AWG	16 - 8	
conductor cross-section (CC contact series)	mm ²	0,14 2,5	
	AWG	26 - 14	
CX/CC stripping length	mm	8 / 9 / 15	
mechanical endurance (mating cycles)		≥ 500	

CX 6 poles (40A - 690V) + 12 poles (10A - 230/400V) + ⊕

enclosures: size "77.27"	page:
C-TYPE IP65 or IP66/IP69	402 - 411
C7 IP67, two levers	439 - 440
V-TYPE IP65 or IP66/IP69, single lever	454 - 458
BIG hoods	470 - 471
T-TYPE IP65 insulating	484 - 485
T-TYPE / W IP66/IP69 insulating	491
HYGIENIC T-TYPE / H IP66/IP69	503
HYGIENIC T-TYPE / C IP66/IP69, -50 °C	508
W-TYPE for aggressive environments	523
E-Xtreme® corrosion proof	534 - 535, 544, 554 - 555
EMC	580
Central lever	609 - 611
LS-TYPE	622 - 623
IP68	640 - 643
panel supports: COB	page: 652 - 653

inserts, crimp connections



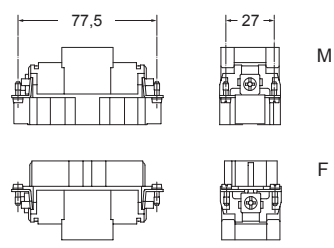
40A and 10A crimp contacts
silver and gold plated



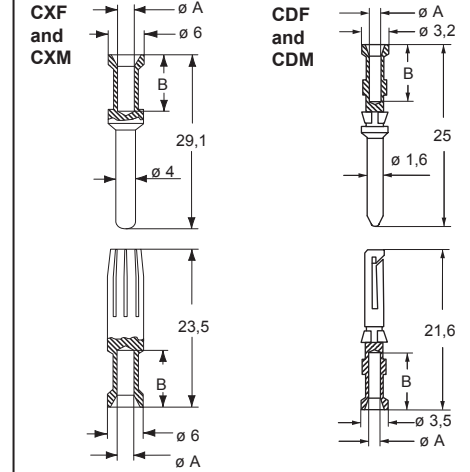
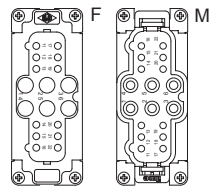
description	part No.	part No.	part No.
-------------	----------	----------	----------

without contacts (to be ordered separately)			
female inserts for female contacts	CXF 6/12		
male inserts for male contacts	CXM 6/12		
40A female crimp contacts		CXFA 1.5	silver plated
1,5 mm ² AWG 16		CXFA 2.5	
2,5 mm ² AWG 14		CXFA 4.0	
4 mm ² AWG 12		CXFA 6.0	
6 mm ² AWG 10		CXFA 10	
40A male crimp contacts		CXMA 1.5	silver plated
1,5 mm ² AWG 16		CXMA 2.5	
2,5 mm ² AWG 14		CXMA 4.0	
4 mm ² AWG 12		CXMA 6.0	
6 mm ² AWG 10		CXMA 10	
10A female contacts		CDFA 0.3	gold plated+
0,14-0,37 mm ² AWG 26-22 identification No. 1		CDFA 0.5	
0,5 mm ² AWG 20 identification No. 2		CDFA 0.7	
0,75 mm ² AWG 18 identification No. ②		CDFA 1.0	
1 mm ² AWG 18 identification No. 3		CDFA 1.5	
1,5 mm ² AWG 16 identification No. 4		CDFA 2.5	
2,5 mm ² AWG 14 identification No. 5			
10A male contacts		CDMA 0.3	gold plated+
0,14-0,37 mm ² AWG 26-22 identification No. 1		CDMA 0.5	
0,5 mm ² AWG 20 identification No. 2		CDMA 0.7	
0,75 mm ² AWG 18 identification No. ②		CDMA 1.0	
1 mm ² AWG 18 identification No. 3		CDMA 1.5	
1,5 mm ² AWG 16 identification No. 4		CDMA 2.5	
2,5 mm ² AWG 14 identification No. 5			

- characteristics according to EN 61984:
- 40A 690V 8kV 3**
- 10A 230/400V 4kV 3**
- cULus (UL for USA and Canada) certified
- insulation resistance: ≥ 10 GΩ
- ambient temperature limit: -40 °C ... +125 °C
- made of self-extinguishing thermoplastic resin UL 94V-0
- mechanical life: ≥ 500 cycles
- contact resistance:
 - ≤ 0,3 mΩ (6 poles)
 - ≤ 1 mΩ (12 poles)
- cable diameter: up to 7,5 mm
- contact section: up to 10 mm²
- **it is recommended to crimp the contacts with crimping tools homologated by ILME** (please see the crimping tool section 40A contacts, CXF, CXM series and 10A contacts CDF, CDM series on pages 708 - 741
- for max. current load see the connector inserts derating diagram below; for more information see page 28

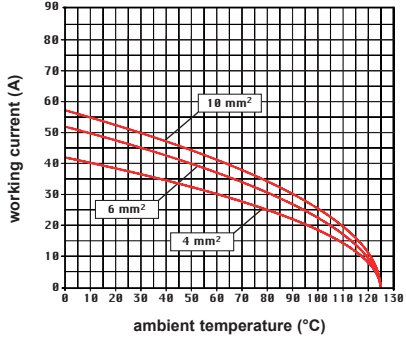


contacts side (front view)



CXF and CXM contacts		
conductor section mm ²	conductor slot ø A (mm)	conductors stripping length B (mm)
1,5	1,8	9
2,5	2,2	9
4	2,85	9,6
6	3,5	9,6
10	4,3	15
CDF and CDM contacts		
0,14-0,37	0,9	8
0,5	1,1	8
0,75	1,3	8
1,0	1,45	8
1,5	1,8	8
2,5	2,2	6

CX 6/12 power poles connector inserts
Maximum current load derating diagram



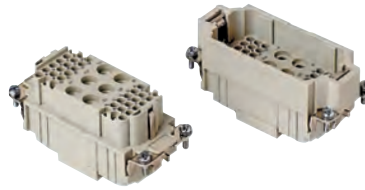
CX 6 poles (40A - 690V) + 36 poles (10A - 160V) + ⊕

enclosures: size "77.27"	page:
C-TYPE IP65 or IP66/IP69	402 - 411
C7 IP67, two levers	439 - 440
V-TYPE IP65 or IP66/IP69, single lever	454 - 458
BIG hoods	470 - 471
T-TYPE IP65 insulating	484 - 485
T-TYPE / W IP66/IP69 insulating	491
HYGIENIC T-TYPE / H IP66/IP69	503
HYGIENIC T-TYPE / C IP66/IP69, -50 °C	508
W-TYPE for aggressive environments	523
E-Xtreme® corrosion proof	534 - 535, 544, 554 - 555
EMC	580
Central lever	609 - 611
LS-TYPE	622 - 623
IP68	640 - 643

panel supports: COB	page: 652 - 653
------------------------	--------------------

- PCBs interface, see article CIF 2.4 (10A contacts)

inserts, crimp connections



40A and 10A crimp contacts silver and gold plated



description	part No.	part No.	part No.
without contacts (to be ordered separately)			
female inserts for female contacts	CXF 6/36		
male inserts for male contacts	CXM 6/36		
40A female crimp contacts		CXFA 1.5	silver plated
1,5 mm ² AWG 16		CXFA 2.5	
2,5 mm ² AWG 14		CXFA 4.0	
4 mm ² AWG 12		CXFA 6.0	
40A male crimp contacts		CXMA 1.5	silver plated
1,5 mm ² AWG 16		CXMA 2.5	
2,5 mm ² AWG 14		CXMA 4.0	
4 mm ² AWG 12		CXMA 6.0	
10A female contacts		CDFA 0.3	gold plated+
0,14-0,37 mm ² AWG 26-22 identification No. 1		CDFA 0.5	
0,5 mm ² AWG 20 identification No. 2		CDFA 0.7	
0,75 mm ² AWG 18 identification No. ②		CDFA 1.0	
1 mm ² AWG 18 identification No. 3		CDFA 1.5	
1,5 mm ² AWG 16 identification No. 4		CDFA 2.5	
2,5 mm ² AWG 14 identification No. 5			
10A male contacts		CDMA 0.3	
0,14-0,37 mm ² AWG 26-22 identification No. 1		CDMA 0.5	
0,5 mm ² AWG 20 identification No. 2		CDMA 0.7	
0,75 mm ² AWG 18 identification No. ②		CDMA 1.0	
1 mm ² AWG 18 identification No. 3		CDMA 1.5	
1,5 mm ² AWG 16 identification No. 4		CDMA 2.5	
2,5 mm ² AWG 14 identification No. 5			

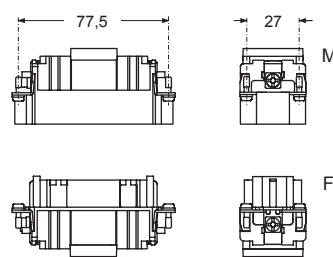
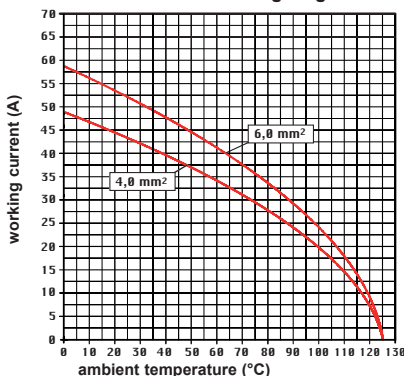
+ for basic or high thickness gold plating, please refer to page 674

- characteristics according to EN 61984:

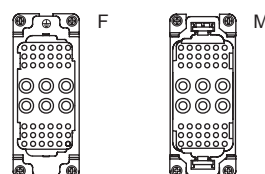
40A 690V 8kV 3
10A 160V 2,5kV 3
10A 250V 4kV 2

- certified
- rated voltage according to UL/CSA: 600V
- insulation resistance: ≥ 10 GΩ
- ambient temperature limit: -40 °C ... +125 °C
- made of self-extinguishing thermoplastic resin UL 94V-0
- mechanical life: ≥ 500 cycles
- contact resistance: ≤ 0,3 mΩ (6 poles), ≤ 1 mΩ (36 poles)
- for max. current load see the connector inserts derating diagram below; for more information see page 28

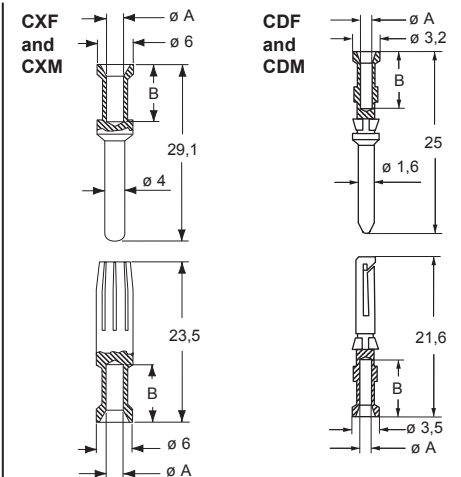
CX 6/36 power poles connector inserts
Maximum current load derating diagram



contacts side (front view)



- it is recommended to crimp the contacts with crimping tools homologated by ILME (please see the crimping tool section 40A contacts, CXF, CXM series and 10A contacts CDF, CDM series on pages 708 - 741



CXF and CXM contacts

conductor section mm ²	conductor slot ø A (mm)	conductors stripping length B (mm)
1,5	1,8	9
2,5	2,2	9
4	2,85	9,6
6	3,5	9,6

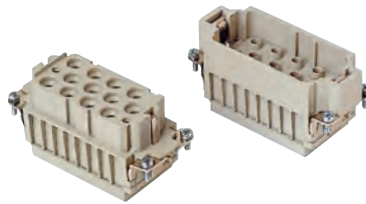
CDF and CDM contacts

0,14-0,37	0,9	8
0,5	1,1	8
0,75	1,3	8
1,0	1,45	8
1,5	1,8	8
2,5	2,2	6

CX 12 poles (40A - 690V) + 2 poles (10A - 250V) + ⊕

enclosures: size "77.27"	page:
C-TYPE IP65 or IP66/IP69	402 - 411
C7 IP67, two levers	439 - 440
V-TYPE IP65 or IP66/IP69, single lever	454 - 458
BIG hoods	470 - 471
T-TYPE IP65 insulating	484 - 485
T-TYPE / W IP66/IP69 insulating	491
HYGIENIC T-TYPE / H IP66/IP69	503
HYGIENIC T-TYPE / C IP66/IP69, -50 °C	508
W-TYPE for aggressive environments	523
E-Xtreme® corrosion proof	534 - 535, 544, 554 - 555
EMC	580
Central lever	609 - 611
LS-TYPE	622 - 623
IP68	640 - 643
panel supports: COB	page: 652 - 653

inserts, crimp connections



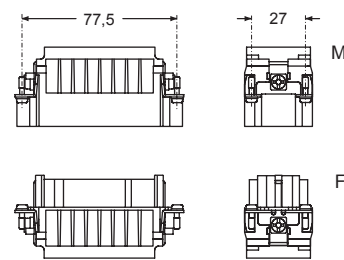
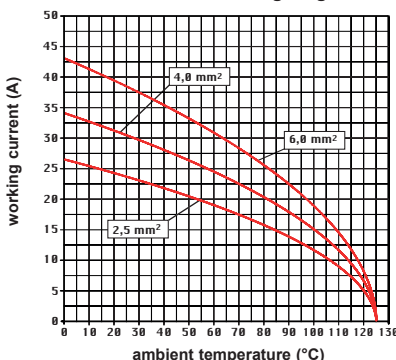
40A and 10A crimp contacts
silver and gold plated



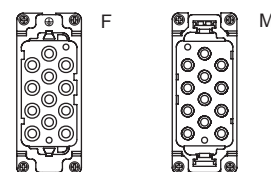
description	part No.	part No.	part No.
without contacts (to be ordered separately)			
female inserts for female contacts	CXF 12/2		
male inserts for male contacts	CXM 12/2		
40A female crimp contacts			
1,5 mm ² AWG 16		CXFA 1.5	silver plated
2,5 mm ² AWG 14		CXFA 2.5	
4 mm ² AWG 12		CXFA 4.0	
6 mm ² AWG 10		CXFA 6.0	
40A male crimp contacts			
1,5 mm ² AWG 16		CXMA 1.5	silver plated
2,5 mm ² AWG 14		CXMA 2.5	
4 mm ² AWG 12		CXMA 4.0	
6 mm ² AWG 10		CXMA 6.0	
10A female contacts			
0,14-0,37 mm ² AWG 26-22 identification No. 1		CDFA 0.3	gold plated+ + for basic or high thickness gold plating, please refer to page 674
0,5 mm ² AWG 20 identification No. 2		CDFA 0.5	
0,75 mm ² AWG 18 identification No. ②		CDFA 0.7	
1 mm ² AWG 18 identification No. 3		CDFA 1.0	
1,5 mm ² AWG 16 identification No. 4		CDFA 1.5	
2,5 mm ² AWG 14 identification No. 5		CDFA 2.5	
10A male contacts			
0,14-0,37 mm ² AWG 26-22 identification No. 1		CDMA 0.3	gold plated+ + for basic or high thickness gold plating, please refer to page 674
0,5 mm ² AWG 20 identification No. 2		CDMA 0.5	
0,75 mm ² AWG 18 identification No. ②		CDMA 0.7	
1 mm ² AWG 18 identification No. 3		CDMA 1.0	
1,5 mm ² AWG 16 identification No. 4		CDMA 1.5	
2,5 mm ² AWG 14 identification No. 5		CDMA 2.5	

- characteristics according to EN 61984:
- 40A 690V 8kV 3**
- 10A 250V 4kV 3**
- certified
- rated voltage according to UL/CSA: 600V
- insulation resistance: ≥ 10 GΩ
- ambient temperature limit: -40 °C ... +125 °C
- made of self-extinguishing thermoplastic resin UL 94V-0
- mechanical life: ≥ 500 cycles
- contact resistance: ≤ 0,3 mΩ (12 poles), ≤ 1 mΩ (2 poles)
- for max. current load see the connector inserts derating diagram below; for more information see page 28

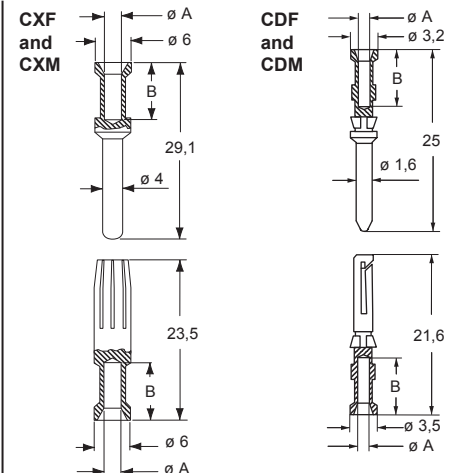
CX 12/2 power poles connector inserts
Maximum current load derating diagram



contacts side (front view)



- it is recommended to crimp the contacts with crimping tools homologated by ILME (please see the crimping tool section 40A contacts, CXF, CXM series and 10A contacts CDF, CDM series on pages 708 - 741



CXF and CXM contacts

conductor section	conductor slot	conductors stripping length
mm ²	ø A (mm)	B (mm)
1,5	1,8	9
2,5	2,2	9
4	2,85	9,6
6	3,5	9,6

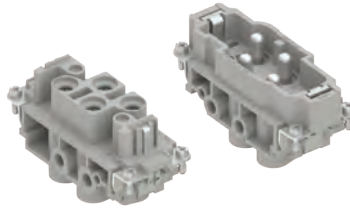
CDF and CDM contacts

0,14-0,37	0,9	8
0,5	1,1	8
0,75	1,3	8
1,0	1,45	8
1,5	1,8	8
2,5	2,2	6

CX 4 poles (80A - 830V) + ⊕

enclosures: size "77.27"	page:
C-TYPE IP65 or IP66/IP69	402 - 411
C7 IP67, two levers	439 - 440
V-TYPE IP65 or IP66/IP69, single lever	454 - 458
BIG hoods	470 - 471
T-TYPE IP65 insulating	484 - 485
T-TYPE / W IP66/IP69 insulating	491
HYGIENIC T-TYPE / H IP66/IP69	503
HYGIENIC T-TYPE / C IP66/IP69, -50 °C	508
W-TYPE for aggressive environments	523
E-Xtreme® corrosion proof	534 - 535, 544, 554 - 555
EMC	580
Central lever	609 - 611
LS-TYPE	622 - 623
IP68	640 - 643
panel supports:	page:
COB	652 - 653

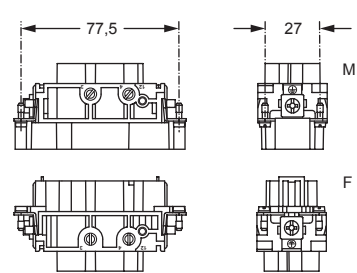
inserts,
screw terminal connection



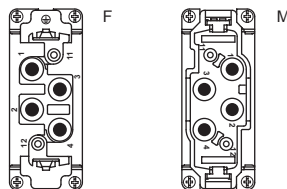
Ⓢ RATING 830V
Ⓢ SILVER PLATED CONTACTS

description	part No.
female inserts with female contacts	CXF 4/0
male inserts with male contacts	CXM 4/0

- characteristics according to EN 61984:
- 80A 830V 8kV 3**
- certified
- rated voltage according to UL/CSA: 600V
- insulation resistance: ≥ 10 GΩ
- ambient temperature limit: -40 °C ... +125 °C
- made of self-extinguishing thermoplastic resin UL 94V-0
- mechanical life: ≥ 500 cycles
- contact resistance: ≤ 0,3 mΩ
- for max. current load see the connector inserts derating diagram below; for more information see page 28

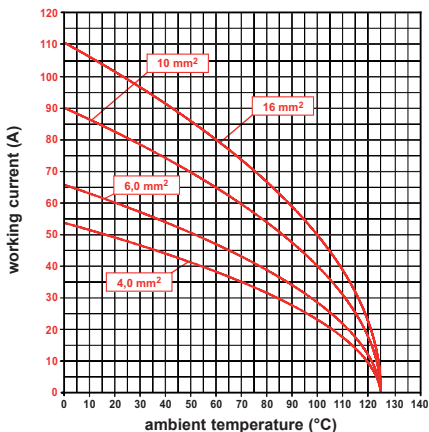


contacts side (front view)



- 80A contacts**
- without plate for section conductors:
4 - 16 mm² - AWG 12 - 6
 - conductors stripping length: 14 mm
 - terminal screw torque: 2,5 Nm (22.1 lb.in),
for more information see page 20 and 21

CX 4/0 poles connector inserts
Maximum current load derating diagram

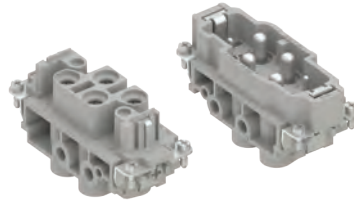


CX 4/0

CX 4 poles (80A - 830V) + 2 poles (16A - 400V) + ⊕

enclosures: size "77.27"	page:
C-TYPE IP65 or IP66/IP69	402 - 411
C7 IP67, two levers	439 - 440
V-TYPE IP65 or IP66/IP69, single lever	454 - 458
BIG hoods	470 - 471
T-TYPE IP65 insulating	484 - 485
T-TYPE / W IP66/IP69 insulating	491
HYGIENIC T-TYPE / H IP66/IP69	503
HYGIENIC T-TYPE / C IP66/IP69, -50 °C	508
W-TYPE for aggressive environments	523
E-Xtreme® corrosion proof	534 - 535, 544, 554 - 555
EMC	580
Central lever	609 - 611
LS-TYPE	622 - 623
IP68	640 - 643
panel supports: COB	page: 652 - 653

inserts,
screw terminal connection



RATING 830V
Q SILVER PLATED CONTACTS

description	part No.
female inserts with female contacts	CXF 4/2
male inserts with male contacts	CXM 4/2

- characteristics according to EN 61984:

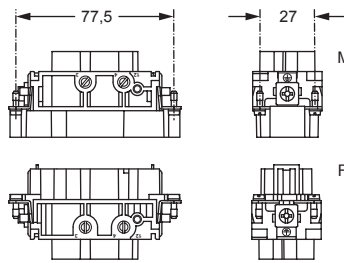
80A 830V 8kV 3
16A 400V 6kV 3
16A 400/690V 6kV 2

- certified

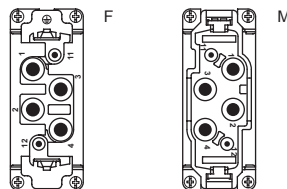
- rated voltage according to UL/CSA: 600V
- insulation resistance: ≥ 10 GΩ
- ambient temperature limit: -40 °C ... +125 °C
- made of self-extinguishing thermoplastic resin UL 94V-0
- mechanical life: ≥ 500 cycles
- contact resistance:
 - ≤ 0,3 mΩ (4 poles)
 - ≤ 1 mΩ (2 poles)
- for max. current load see the connector inserts derating diagrams on the side; for more information see page 28

NOTE

Any cross-sectional area on the signal side higher than that combined to the relevant cross-sectional area on the power side may be used, but with the derating curve for the cross-sectional area given as combined to that on the power side.



contacts side (front view)



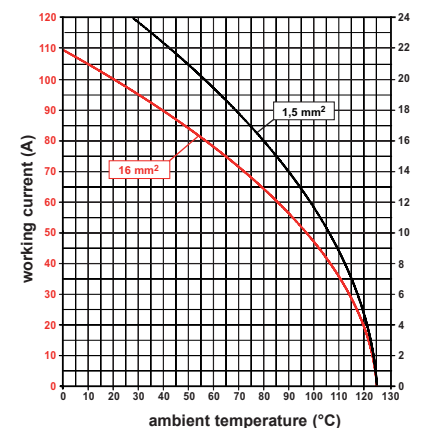
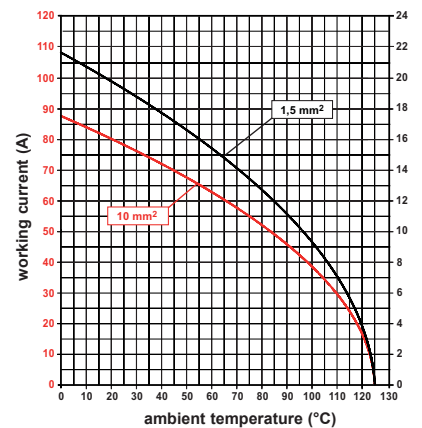
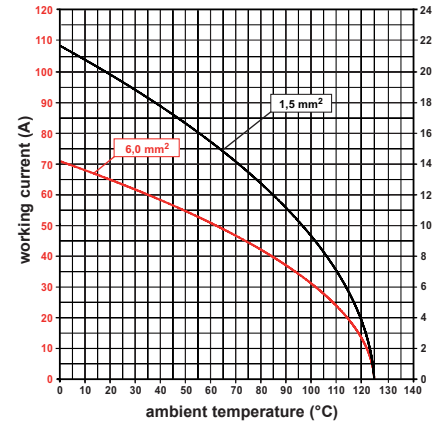
80A contacts

- without plate for section conductors: 4 - 16 mm² - AWG 12 - 6
- conductors stripping length: 14 mm
- terminal screw torque: 2,5 Nm (22.1 lb.in), for more information see page 20 and 21

16A contacts

- without plate for section conductors: 0,25 - 2,5 mm² - AWG 24 - 14
- conductors stripping length: 7 mm
- terminal screw torque: 0,5 Nm (4.4 lb.in), for more information see page 20 and 21

CX 4/2 poles connector inserts
Maximum current load derating diagram



enclosures:
size "77.27"

page:

inserts,
screw terminal connection

For 180 °C

588



RATING 830V

180 °C

SILVER PLATED CONTACTS

description

part No.

use in temperatures up to 180 °C
female inserts with female contacts, brown
male inserts with male contacts, brown

CXF 4/0 RY
CXM 4/0 RY

- characteristics according to EN 61984:

80A 830V 8kV 3

- certified

- rated voltage according to UL/CSA: 600V

- insulation resistance: $\geq 10 \text{ G}\Omega$

- ambient temperature limit: -40 °C ... +180 °C

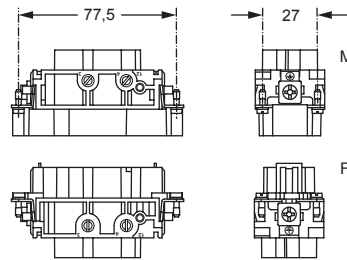
- made of self-extinguishing thermoplastic resin
UL 94V-0

- mechanical life: ≥ 500 cycles

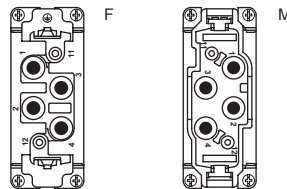
- contact resistance:

$\leq 0,3 \text{ m}\Omega$

- for max. current load see the connector inserts derating
diagram below; for more information see page 28



contacts side (front view)



80A contacts

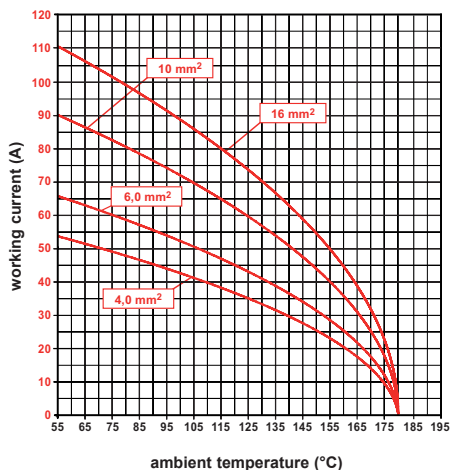
- without plate for section conductors:

4-16 mm² - AWG 12-6

- conductors stripping length: 14 mm

- terminal screw torque: 2,5 Nm (22.1 lb.in),
for more information see page 20 and 21

CX...RY 4/0 poles connector inserts
Maximum current load derating diagram





enclosures:
size "77.27"

page:

inserts,
screw terminal connection

For 180 °C

588



RATING 830V

180 °C

SILVER PLATED CONTACTS

description

part No.

use in temperatures up to 180 °C
female inserts with female contacts, brown
male inserts with male contacts, brown

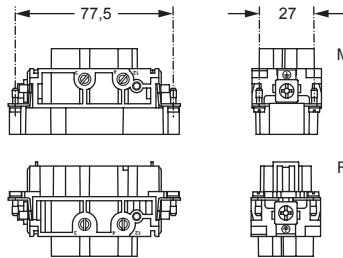
CXF 4/2 RY
CXM 4/2 RY

- characteristics according to EN 61984:
80A 830V 8kV 3
16A 400V 6kV 3
16A 400/690V 6kV 2
- certified
- rated voltage according to UL/CSA: 600V
- insulation resistance: ≥ 10 G Ω
- ambient temperature limit: -40 °C ... +180 °C
- made of self-extinguishing thermoplastic resin UL 94V-0

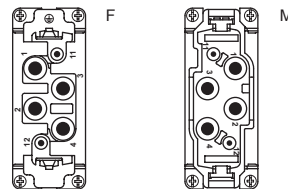
- mechanical life: ≥ 500 cycles
- contact resistance:
 $\leq 0,3$ m Ω (4 poles)
 ≤ 1 m Ω (2 poles)
- for max. current load see the connector inserts derating diagrams on the side; for more information see page 28

NOTE

Any cross-sectional area on the signal side higher than that combined to the relevant cross-sectional area on the power side may be used, but with the derating curve for the cross-sectional area given as combined to that on the power side.



contacts side (front view)



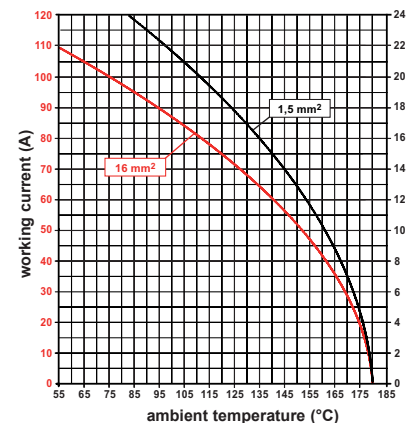
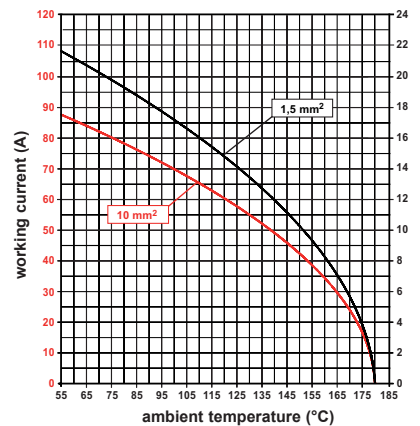
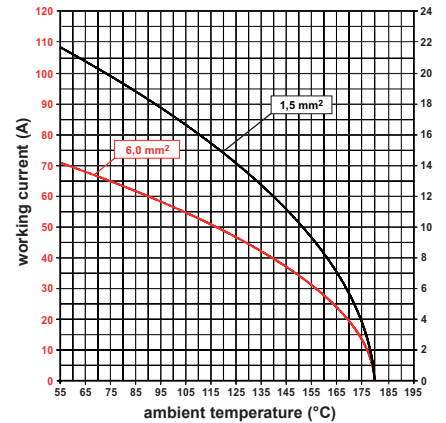
80A contacts

- without plate for section conductors:
4 - 16 mm² - AWG 12 - 6
- conductors stripping length: 14 mm
- terminal screw torque: 2,5 Nm (22.1 lb.in),
for more information see page 20 and 21

16A contacts

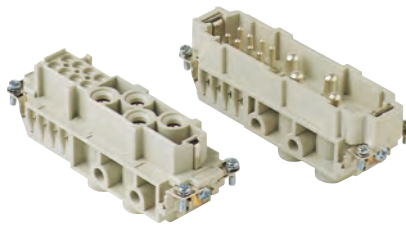
- without plate for section conductors:
0,25 - 2,5 mm² - AWG 24 - 14
- conductors stripping length: 7 mm
- terminal screw torque: 0,5 Nm (4.4 lb.in),
for more information see page 20 and 21

CX..RY 4/2 poles connector inserts
Maximum current load derating diagram



enclosures: size "104.27"	page:
CX 4/8:	
C-TYPE IP65 or IP66/IP69	412 - 423
C7 IP67, two levers	441 - 442
V-TYPE IP65 or IP66/IP69, single lever	459 - 463
BIG hoods	472 - 473
T-TYPE IP65 insulating	486 - 487
T-TYPE / W IP66/IP69 insulating	492
HYGIENIC T-TYPE / H IP66/IP69	504
HYGIENIC T-TYPE / C IP66/IP69, -50 °C	509
W-TYPE for aggressive environments	524
E-Xtreme® corrosion proof	536 - 537, 545, 556 - 557
EMC	581
Central lever	612 - 614
LS-TYPE	624 - 625
IP68	644 - 647
panel supports: COB	652 - 653
CX 4/8 RY: For 180 °C	589

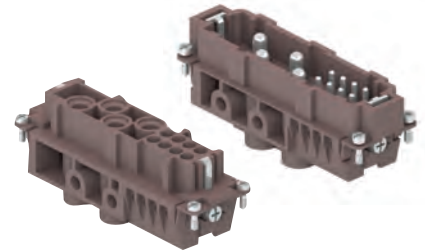
inserts,
screw terminal connection



Q SILVER PLATED CONTACTS

part No.

inserts,
screw terminal connection



180 °C

Q SILVER PLATED CONTACTS

part No

description

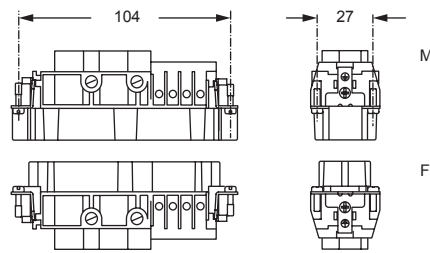
female inserts with female contacts
male inserts with male contacts
use in temperatures up to 180 °C
female inserts with female contacts
male inserts with male contacts

CXF 4/8
CXM 4/8

CXF 4/8 RY
CXM 4/8 RY

- characteristics according to EN 61984:
80A 400V 6kV 3
80A 400/690V 6kV 2
16A 230/400V 4kV 3
16A 400V 4kV 2
- certified
- rated voltage according to UL/CSA: 600V
- insulation resistance: ≥ 10 G Ω
- ambient temperature limit: -40 °C ... +125 °C (CX)
- ambient temperature limit: -40 °C ... +180 °C (CX...RY)
- made of self-extinguishing thermoplastic resin UL 94V-0
- mechanical life: ≥ 500 cycles
- contact resistance:
 $\leq 0,3$ m Ω (4 poles)
 ≤ 1 m Ω (8 poles)
- for max. current load see the connector inserts derating diagrams on the side; for more information see page 28

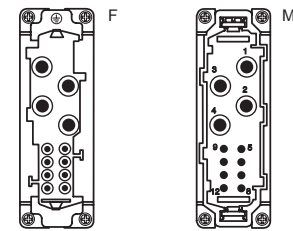
CX - CX..RY



80A contacts

- without plate for section conductors:
4 - 16 mm² - AWG 12 - 6
- conductors stripping length: 14 mm
- terminal screw torque: 2,5 Nm (22.1 lb.in), for more information see page 20 and 21

contacts side (front view)



16A contacts

- with plate for section conductors:
0,75 - 2,5 mm² - AWG 18 - 14
- conductors stripping length: 7 mm
- terminal screw torque: 0,5 Nm (4.4 lb.in), for more information see page 20 and 21

The derating curves for the connector's **power** (red) and **signal** (black) portions provided in the diagram are valid for the following combinations of cross-sectional area on the power side and on the signal side:

- power 4 mm² with signal 1 mm²;
- power 6 mm² with signal 1 mm²;
- power 10 mm² or 6 mm² with signal 1,5 mm²;
- power 16 mm² with signal 2,5 mm²;

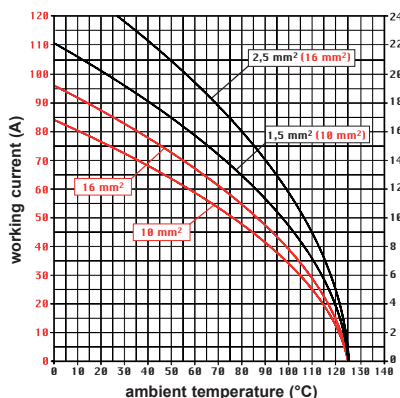
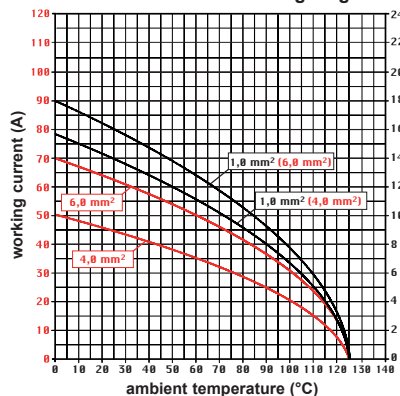
NOTE 1

Any cross-sectional area on the signal side higher than that combined to the relevant cross-sectional area on the power side may be used, but with the derating curve for the cross-sectional area given as combined to that on the power side.

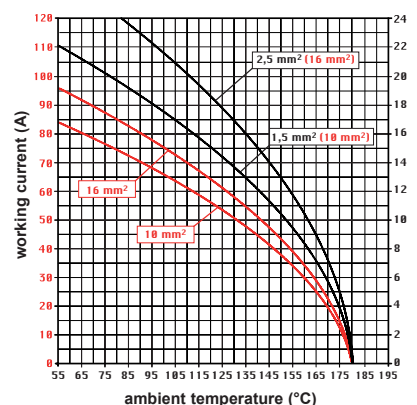
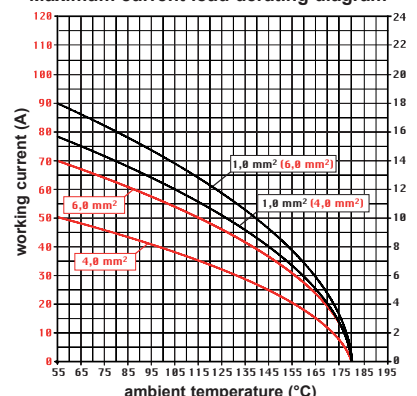
NOTE 2

Any cross-sectional area on the signal side lower than that combined to the relevant cross-sectional area on the power side (e.g. 1 mm² signal with 16 mm² power) may be used at the current indicated for the signal cross-sectional area belonging to the closest lower cross-sectional area on the power side (i.e. the 1 mm² curve combined to the 6 mm² power section).

CX 4/8 poles connector inserts
Maximum current load derating diagrams



CX..RY 4/8 poles connector inserts
Maximum current load derating diagram



CX - CX...RY 4/8

CX 6/6 inserts 100A/16A version

The CX series of combined “power /auxiliaries” connector inserts has been enhanced with **insert, CX 6/6 suitable for currents up to 100A** in the power side and 16A on the auxiliaries side, for crimp contacts series CG (100A max) and series CC (16A max) several benefits over conventional screw or axial screw contacts:

- more **resistant to mechanical stresses** such as vibrations, shock and cable loads;
- more **corrosion resistant** (gas tight);
- **quicker to connect** and ensuring more **consistent results** (regardless of the operators “force”);
- the connector is **electrically more efficient** (reduced voltage drop).

This innovative insert design, by following the same concepts of the MIXO 100A CX..G model, **patented by ILME**, ensures a quicker fitting and removal of crimped contacts.

The **provided locking keys** firmly fasten the contact holder.

The power contacts may be removed **without any special tool**, using a simple screwdriver (e.g.: 0,5 x 3 mm, 0,5 x 3,5 mm, 0,6 x 4 mm and 0,8 x 4 mm flat blade).

The removal of auxiliary contacts series CC requires the CQES extraction tool. See figure below.

The crimping operation may be carried out quickly and efficiently with the **hand operated hydraulic pliers**, which is pre-fitted with the suitable locator. Suitable crimp dies are available on request.

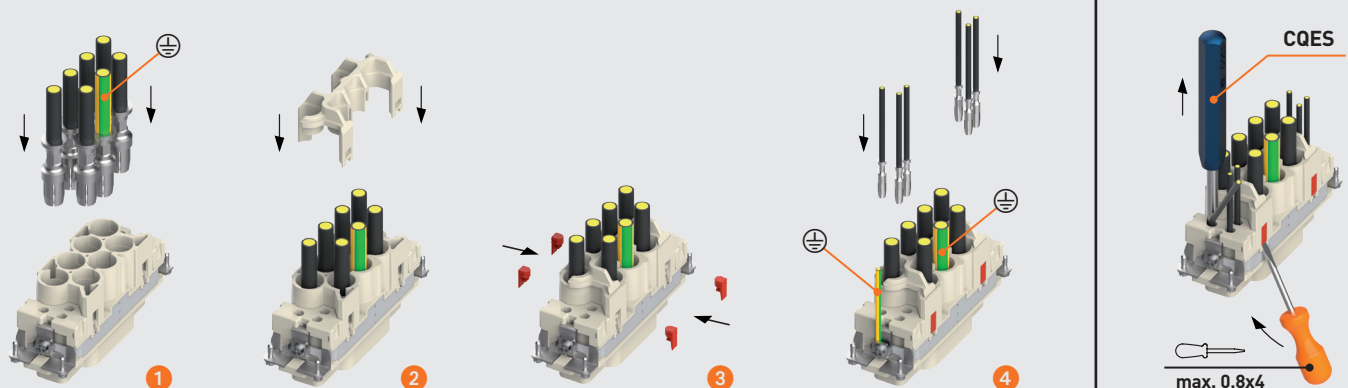
Inserts series		CX 6/6	
No. of poles	main contact	6 + ⊕ (100A) **	
	auxiliary contacts	6 (16A)	
rated current ¹⁾		100A	16A
EN 61984	rated voltage	690V	400V
	rated impulse withstand voltage	8kV	6kV
	pollution degree	3	3
contact resistance		≤ 0,3 mΩ (100A) ≤ 1 mΩ (16A)	
insulation resistance		≥ 10 GΩ	
ambient temperature limit (°C)	min	-40 °C	
	max	+125 °C	
degree of protection	with enclosures (according to version)	IP65, IP66/IP69, IP66/IP67/IP69, IP66/IP68/IP69	
	without enclosures (in mated condition)	IP20 (IPXXB)	
conductor connections *		crimp	
conductor cross-section (CG contact series)	mm ²	8 - 10, 16, 25, 35	
	AWG	8 - 7, 6 - 5, 4 - 3, 2	
conductor cross-section (CC contact series)	mm ²	0,14 4,0	
	AWG	26 - 12	
CG/CC stripping length	mm	15 / 7,5	
mechanical endurance (mating cycles)		≥ 500	

¹⁾ Please check the insert load curves to establish the actual maximum operating current according to the ambient temperature.

* max external conductor Ø = 11,5 mm

** the power PE contact is not included and must be the same size as the power contacts used (for a total n° at contacts = 7)

CX 6/6 Assembling instructions



CX 6 poles + ⊕ (100A - 690V) + 6 poles (16A - 400V) + ⊖

enclosures: size "104.27"	page:
C-TYPE IP65 or IP66/IP69	412 - 423
C7 IP67, two levers	441 - 442
V-TYPE IP65 or IP66/IP69, single lever	459 - 463
BIG hoods	472 - 473
T-TYPE IP65 insulating	486 - 487
T-TYPE / W IP66/IP69 insulating	492
HYGIENIC T-TYPE / H IP66/IP69	504
HYGIENIC T-TYPE / C IP66/IP69, -50 °C	509
W-TYPE for aggressive environments	524
E-Xtreme® corrosion proof	536 - 537, 545, 556 - 557
EMC	581
Central lever	612 - 614
LS-TYPE	624 - 625
IP68	644 - 647

panel supports: COB	page: 652 - 653
------------------------	--------------------

enclosures:
bulkhead mounting housings, high construction housings
or high construction hoods

inserts, crimp connections



100A and 16A crimp contacts silver and gold plated



description	part No.	part No.	part No.
-------------	----------	----------	----------

without contacts (to be ordered separately)
female inserts for female contacts **CXF 6/6**
male inserts for male contacts **CXM 6/6**

100A female crimp contacts
8 - 10 mm² AWG 8 - 7
16 mm² AWG 6 - 5
25 mm² AWG 4 - 3
35 mm² AWG 2

CGFA 10
CGFA 16
CGFA 25
CGFA 35

silver plated

+ for basic or high thickness gold plating, please refer to page 675

100A male crimp contacts
8 - 10 mm² AWG 8 - 7
16 mm² AWG 6 - 5
25 mm² AWG 4 - 3
35 mm² AWG 2

CGMA 10
CGMA 16
CGMA 25
CGMA 35

16A female contacts
0,14-0,37 mm² AWG 26-22 one groove
0,5 mm² AWG 20 with no grooves
0,75 mm² AWG 18 one groove (back side)
1 mm² AWG 18 one groove
1,5 mm² AWG 16 two grooves
2,5 mm² AWG 14 three grooves
3 mm² AWG 12 one wide groove
4 mm² AWG 12 with no grooves

CCFA 0.3
CCFA 0.5
CCFA 0.7
CCFA 1.0
CCFA 1.5
CCFA 2.5
CCFA 3.0
CCFA 4.0

CCFD 0.3
CCFD 0.5
CCFD 0.7
CCFD 1.0
CCFD 1.5
CCFD 2.5
CCFD 3.0
CCFD 4.0

gold plated

16A male contacts
0,14-0,37 mm² AWG 26-22 one groove
0,5 mm² AWG 20 with no grooves
0,75 mm² AWG 18 one groove (back side)
1 mm² AWG 18 one groove
1,5 mm² AWG 16 two grooves
2,5 mm² AWG 14 three grooves
3 mm² AWG 12 one wide groove
4 mm² AWG 12 with no grooves

CCMA 0.3
CCMA 0.5
CCMA 0.7
CCMA 1.0
CCMA 1.5
CCMA 2.5
CCMA 3.0
CCMA 4.0

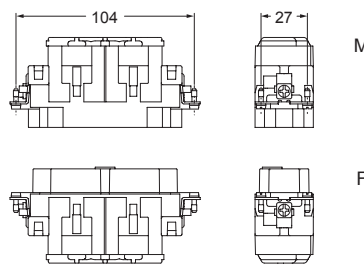
CCMD 0.3
CCMD 0.5
CCMD 0.7
CCMD 1.0
CCMD 1.5
CCMD 2.5
CCMD 3.0
CCMD 4.0

- characteristics according to EN 61984:

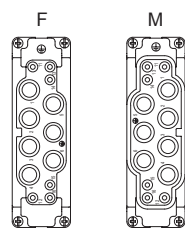
100A 690V 8kV 3
16A 400V 6kV 3

- us (UL for USA and Canada),

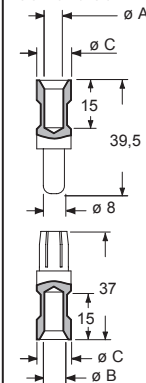
- certified
- rated voltage according to UL/CSA: 600V
- insulation resistance: ≥ 10 GΩ
- ambient temperature limit: -40 °C ... +125 °C
- made of self-extinguishing thermoplastic resin UL 94V-0
- mechanical life: ≥ 500 cycles
- contact resistance: ≤ 0,3 mΩ (100A), ≤ 1 mΩ (16A)
- for max. current load see the connector inserts derating diagram below; for more information see page 28



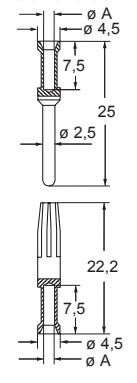
contacts side (front view)



CGF and CGM



CCF and CCM



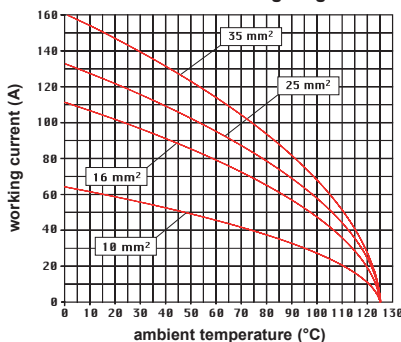
CGF and CGM contacts

conductor section (mm ²)	conductor slot ø A (mm)	ø B (mm)	ø C (mm)	conductor stripping length (mm)
8-10	4,3	4,3	13	15
16	5,5	5,5	13	15
25	7,0	7,0	13	15
35	7,9	8,2	12,5	15

CCF and CCM contacts

conductor section (mm ²)	conductor slot ø A (mm)	conductors stripping length (mm)
0,14-0,37	0,9	7,5
0,5	1,1	7,5
0,75	1,3	7,5
1,0	1,45	7,5
1,5	1,8	7,5
2,5	2,2	7,5
3	2,55	7,5
4	2,85	7,5

CX 6/6 power poles connector inserts
Maximum current load derating diagram



- it is recommended to crimp the contacts with crimping tools homologated by ILME (please see the crimping tool section 100A contacts CGF, CGM series and 16A contacts CCF, CCM series) on pages 708 - 741

HNM series

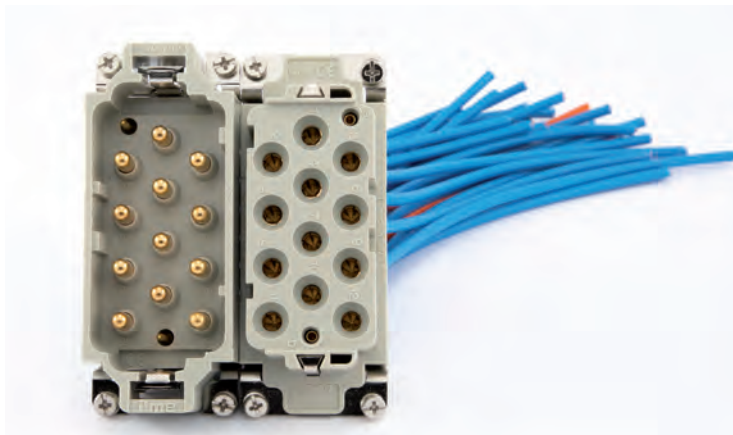
TECHNICAL FEATURES

Specifically designed for applications requiring a high number of mating cycles, the **HNM series** guarantees **up to 10.000 matings**.

Ideal for test benches, the special **HNM inserts** guarantee 10.000 matings when used together with the **dedicated enclosure series**, thanks to the special antifriction treatment applied both on the contacts of the inserts and on the V-TYPE locking lever and the riveted pegs (available only in the single lever version).

5.000 matings are achieved when working with standard enclosures single lever, with V-TYPE or CLASS locking lever and riveted pegs on the hoods (therefore the size "44.27" is excluded).

The series features **special versions of the 10 and 16 A gold plated crimp contacts** to be used both with **special crimp inserts** (up to 108 poles) and with standard MIXO inserts mounted in **special frames** equipped with **gold PE contacts**.



SUM-UP

- ☑ **Special treatment + special lubricant**
- ☑ **HNM marking on each insert**

Q NOTE

For contacts in **HNM** version (series **RI, RD, RC** and **RX**) the same tools are suitable for crimping, insertion/extraction (where indicated), as those used for the corresponding contacts in standard version (respectively series **CI, CD, CC** and **CX**).

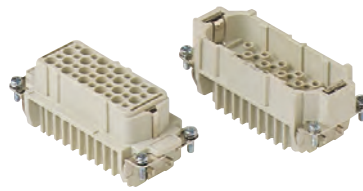
RD 40 poles + ⊕ 10A - 250V HNM (High Number of Matings)

enclosures:
size "77.27"

page:

HNM 596 - 597
C-TYPE IP65 or IP66/IP69, single lever 402 - 411
V-TYPE IP65 or IP66/IP69, single lever 454 - 458

inserts, crimp connections



10A crimp contacts
gold plated



Q 10.000 MATINGS WITH HNM ENCLOSURES

Q 5.000 MATINGS WITH STANDARD ENCLOSURES, SINGLE LEVER

description

part No.

part No.

without contacts (to be ordered separately)
female inserts for female contacts
male inserts for male contacts

RDF 40
RDM 40

10A female contacts

0,14-0,37 mm ²	AWG 26-22	identification No. 1
0,5 mm ²	AWG 20	identification No. 2
0,75 mm ²	AWG 18	identification No. ②
1 mm ²	AWG 18	identification No. 3
1,5 mm ²	AWG 16	identification No. 4
2,5 mm ²	AWG 14	identification No. 5

RDF2D 0.3
RDF2D 0.5
RDF2D 0.7
RDF2D 1.0
RDF2D 1.5
RDF2D 2.5

gold plated

10A male contacts

0,14-0,37 mm ²	AWG 26-22	identification No. 1
0,5 mm ²	AWG 20	identification No. 2
0,75 mm ²	AWG 18	identification No. ②
1 mm ²	AWG 18	identification No. 3
1,5 mm ²	AWG 16	identification No. 4
2,5 mm ²	AWG 14	identification No. 5

RDM2D 0.3
RDM2D 0.5
RDM2D 0.7
RDM2D 1.0
RDM2D 1.5
RDM2D 2.5

- characteristics according to EN 61984:

10A 250V 4kV 3
10A 230/400V 4kV 2

- DNV-GL VERITAS ENEC certified

- rated voltage according to UL/CSA: 600V

- insulation resistance: ≥ 10 GΩ

- ambient temperature limit: -40 °C ... +125 °C

- made of self-extinguishing thermoplastic resin
UL 94V-0

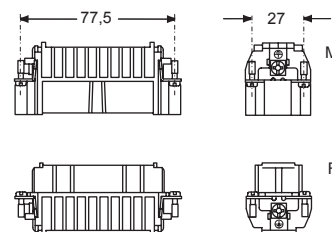
- mechanical life: ≥ 10.000 cycles

- contact resistance: ≤ 3 mΩ

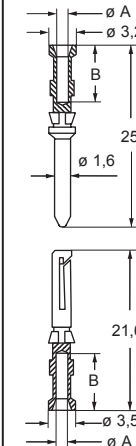
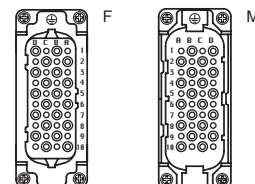
- for applications requiring higher voltages, please see
the special voltage application section on page 65

- **it is recommended to crimp the contacts with
crimping tools homologated by ILME** (please
see the crimping tool section 10A contacts, RDF2D and
RDM2D series) on pages 708 - 741

- for max. current load see the connector inserts derating
diagram below; for more information see page 28



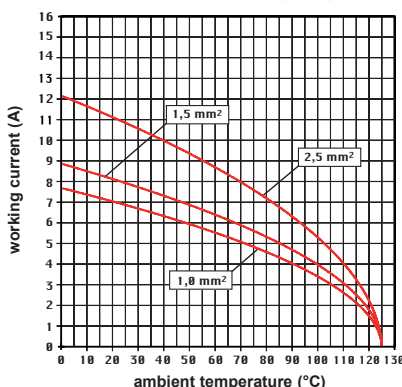
contacts side (front view)



RDF2D and RDM2D contacts

conductor section mm ²	conductor slot Ø A (mm)	conductors stripping length B (mm)
0,14-0,37	0,9	8
0,5	1,1	8
0,75	1,3	8
1,0	1,45	8
1,5	1,8	8
2,5	2,2	6

RD 40 poles connector inserts
Maximum current load derating diagram



CR CP coding pin
with loss of one contact
(page 689)



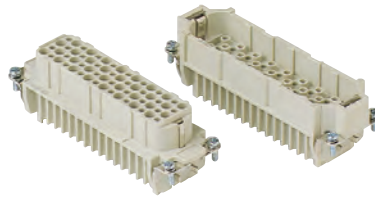
RD 64 poles + ⊕ 10A - 250V HNM (High Number of Matings)

enclosures:
size "104.27"

page:

HNM 598 - 599
C-TYPE IP65 or IP66/IP69, single lever 412 - 423
V-TYPE IP65 or IP66/IP69, single lever 459 - 463

inserts, crimp connections



10A crimp contacts
gold plated



Q 10.000 MATINGS WITH HNM ENCLOSURES

Q 5.000 MATINGS WITH STANDARD ENCLOSURES, SINGLE LEVER

description	part No.	part No.
-------------	----------	----------

without contacts (to be ordered separately)
female inserts for female contacts
male inserts for male contacts

RDF 64
RDM 64

10A female contacts

cross-section	AWG	identification No.
0,14-0,37 mm ²	AWG 26-22	identification No. 1
0,5 mm ²	AWG 20	identification No. 2
0,75 mm ²	AWG 18	identification No. ②
1 mm ²	AWG 18	identification No. 3
1,5 mm ²	AWG 16	identification No. 4
2,5 mm ²	AWG 14	identification No. 5

RDF2D 0.3
RDF2D 0.5
RDF2D 0.7
RDF2D 1.0
RDF2D 1.5
RDF2D 2.5

gold plated

10A male contacts

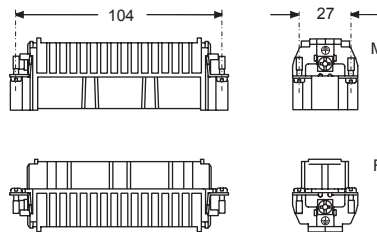
cross-section	AWG	identification No.
0,14-0,37 mm ²	AWG 26-22	identification No. 1
0,5 mm ²	AWG 20	identification No. 2
0,75 mm ²	AWG 18	identification No. ②
1 mm ²	AWG 18	identification No. 3
1,5 mm ²	AWG 16	identification No. 4
2,5 mm ²	AWG 14	identification No. 5

RDM2D 0.3
RDM2D 0.5
RDM2D 0.7
RDM2D 1.0
RDM2D 1.5
RDM2D 2.5

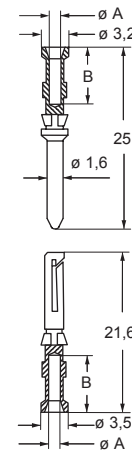
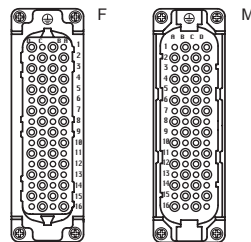
- characteristics according to EN 61984:

10A 250V 4kV 3
10A 230/400V 4kV 2

- DNV-GL, TÜV SÜD, VDE, ENEC certified
- rated voltage according to UL/CSA: 600V
- insulation resistance: ≥ 10 GΩ
- ambient temperature limit: -40 °C ... +125 °C
- made of self-extinguishing thermoplastic resin UL 94V-0
- mechanical life: ≥ 10.000 cycles
- contact resistance: ≤ 3 mΩ
- for applications requiring higher voltages, please see the special voltage application section on page 65
- **it is recommended to crimp the contacts with crimping tools homologated by ILME** (please see the crimping tool section 10A contacts, RDF2D and RDM2D series) on pages 708 - 741
- for max. current load see the connector inserts derating diagram below; for more information see page 28



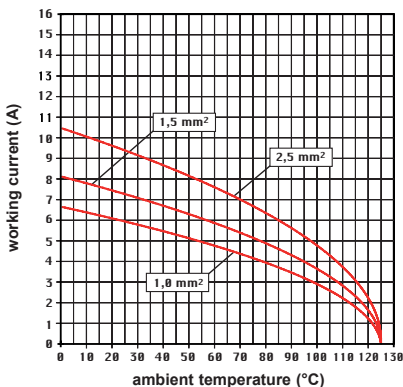
contacts side (front view)



RDF2D and RDM2D contacts

conductor section mm ²	conductor slot ø A (mm)	conductors stripping length B (mm)
0,14-0,37	0,9	8
0,5	1,1	8
0,75	1,3	8
1,0	1,45	8
1,5	1,8	8
2,5	2,2	6

RD 64 poles connector inserts
Maximum current load derating diagram



CR CP coding pin with loss of one contact (page 689)



RDD 24 poles + ⊕ 10A - 250V HNM (High Number of Matings)

enclosures:
size "44.27"

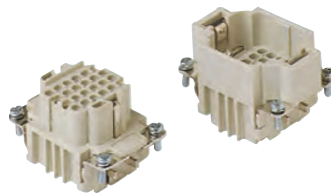
page:

HNM

592 - 593

inserts, crimp connections

10A crimp contacts
gold plated



Q 10.000 MATINGS WITH HNM ENCLOSURES

description

part No.

part No.

without contacts (to be ordered separately)
female inserts for female contacts
male inserts for male contacts

RDDF 24
RDDM 24

10A female contacts

0,14-0,37 mm ²	AWG 26-22	identification No. 1
0,5 mm ²	AWG 20	identification No. 2
0,75 mm ²	AWG 18	identification No. ②
1 mm ²	AWG 18	identification No. 3
1,5 mm ²	AWG 16	identification No. 4
2,5 mm ²	AWG 14	identification No. 5

RDF2D 0.3
RDF2D 0.5
RDF2D 0.7
RDF2D 1.0
RDF2D 1.5
RDF2D 2.5

gold plated

10A male contacts

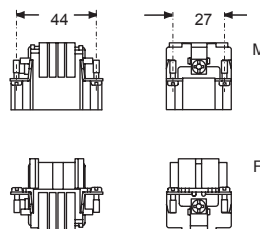
0,14-0,37 mm ²	AWG 26-22	identification No. 1
0,5 mm ²	AWG 20	identification No. 2
0,75 mm ²	AWG 18	identification No. ②
1 mm ²	AWG 18	identification No. 3
1,5 mm ²	AWG 16	identification No. 4
2,5 mm ²	AWG 14	identification No. 5

RDM2D 0.3
RDM2D 0.5
RDM2D 0.7
RDM2D 1.0
RDM2D 1.5
RDM2D 2.5

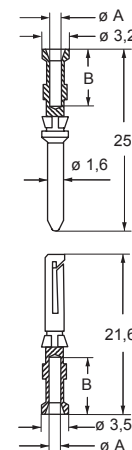
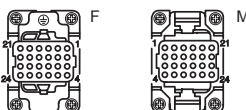
- characteristics according to EN 61984:

10A 250V 4kV 2

- certified
- rated voltage according to UL/CSA: 600V
- insulation resistance: ≥ 10 GΩ
- ambient temperature limit: -40 °C ... +125 °C
- made of self-extinguishing thermoplastic resin UL 94V-0
- mechanical life: ≥ 10.000 cycles
- contact resistance: ≤ 3 mΩ
- for applications requiring higher voltages, please see the special voltage application section on page 75
- **it is recommended to crimp the contacts with crimping tools homologated by ILME** (please see the crimping tool section 10A contacts, RDF2D and RDM2D series) on pages 708 - 741
- PCBs interface, see article CIF 2.4
- for max. current load see the connector inserts derating diagram below; for more information see page 28



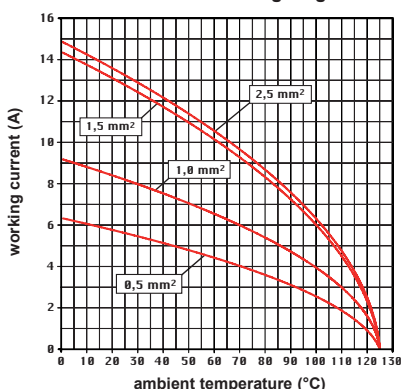
contacts side (front view)



RDF2D and RDM2D contacts

conductor section mm ²	conductor slot diameter A (mm)	conductors stripping length B (mm)
0,14-0,37	0,9	8
0,5	1,1	8
0,75	1,3	8
1,0	1,45	8
1,5	1,8	8
2,5	2,2	6

RDD 24 poles connector inserts
Maximum current load derating diagram



CR CP coding pin
with loss of one contact
(page 689)

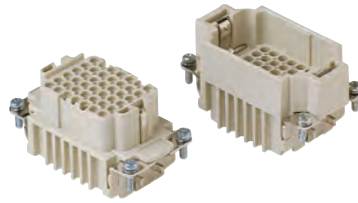


RDD 42 poles + ⊕ 10A - 250V HNM (High Number of Matings)

enclosures:
size "57.27" page:

HNM 594 - 595
C-TYPE IP65 or IP66/IP69, single lever 393 - 401
V-TYPE IP65 or IP66/IP69, single lever 448 - 453

inserts, crimp connections



10A crimp contacts
gold plated



Q 10.000 MATINGS WITH HNM ENCLOSURES
Q 5.000 MATINGS WITH STANDARD ENCLOSURES, SINGLE LEVER

description	part No.	part No.
-------------	----------	----------

without contacts (to be ordered separately)
female inserts for female contacts
male inserts for male contacts

10A female contacts

0,14-0,37 mm ²	AWG 26-22	identification No. 1
0,5 mm ²	AWG 20	identification No. 2
0,75 mm ²	AWG 18	identification No. ②
1 mm ²	AWG 18	identification No. 3
1,5 mm ²	AWG 16	identification No. 4
2,5 mm ²	AWG 14	identification No. 5

RDDF 42
RDDM 42

RDF2D 0.3
RDF2D 0.5
RDF2D 0.7
RDF2D 1.0
RDF2D 1.5
RDF2D 2.5

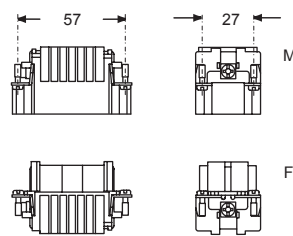
gold plated

10A male contacts

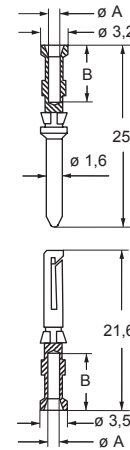
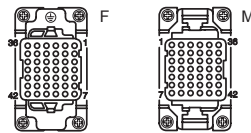
0,14-0,37 mm ²	AWG 26-22	identification No. 1
0,5 mm ²	AWG 20	identification No. 2
0,75 mm ²	AWG 18	identification No. ②
1 mm ²	AWG 18	identification No. 3
1,5 mm ²	AWG 16	identification No. 4
2,5 mm ²	AWG 14	identification No. 5

RDM2D 0.3
RDM2D 0.5
RDM2D 0.7
RDM2D 1.0
RDM2D 1.5
RDM2D 2.5

- characteristics according to EN 61984:
- 10A 250V 4kV 2**
- certified
- rated voltage according to UL/CSA: 600V
- insulation resistance: ≥ 10 GΩ
- ambient temperature limit: -40 °C ... +125 °C
- made of self-extinguishing thermoplastic resin UL 94V-0
- mechanical life: ≥ 10.000 cycles
- contact resistance: ≤ 3 mΩ
- for applications requiring higher voltages, please see the special voltage application section on page 75
- **it is recommended to crimp the contacts with crimping tools homologated by ILME** (please see the crimping tool section 10A contacts, RDF2D and RDM2D series) on pages 708 - 741
- PCBs interface, see article CIF 2.4
- for max. current load see the connector inserts derating diagram below; for more information see page 28



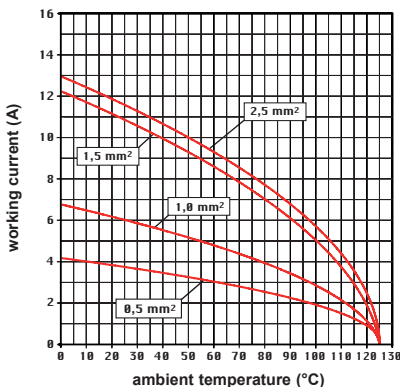
contacts side (front view)



RDF2D and RDM2D contacts

conductor section mm ²	conductor slot ø A (mm)	conductors stripping length B (mm)
0,14-0,37	0,9	8
0,5	1,1	8
0,75	1,3	8
1,0	1,45	8
1,5	1,8	8
2,5	2,2	6

RDD 42 poles connector inserts
Maximum current load derating diagram



CR CP coding pin with loss of one contact (page 689)



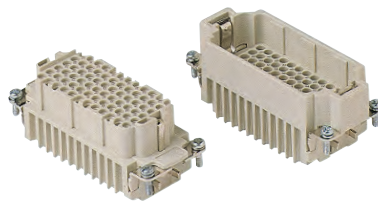
RDD 72 poles + ⊕ 10A - 250V HNM (High Number of Matings)

enclosures:
size "77.27"

page:

HNM 596 - 597
C-TYPE IP65 or IP66/IP69, single lever 402 - 411
V-TYPE IP65 or IP66/IP69, single lever 454 - 458

inserts, crimp connections



10A crimp contacts
gold plated



Q 10.000 MATINGS WITH HNM ENCLOSURES

Q 5.000 MATINGS WITH STANDARD ENCLOSURES, SINGLE LEVER

description

part No.

part No.

without contacts (to be ordered separately)
female inserts for female contacts
male inserts for male contacts

RDDF 72
RDDM 72

10A female contacts

0,14-0,37 mm ²	AWG 26-22	identification No. 1
0,5 mm ²	AWG 20	identification No. 2
0,75 mm ²	AWG 18	identification No. ②
1 mm ²	AWG 18	identification No. 3
1,5 mm ²	AWG 16	identification No. 4
2,5 mm ²	AWG 14	identification No. 5

RDF2D 0.3
RDF2D 0.5
RDF2D 0.7
RDF2D 1.0
RDF2D 1.5
RDF2D 2.5

gold plated

10A male contacts

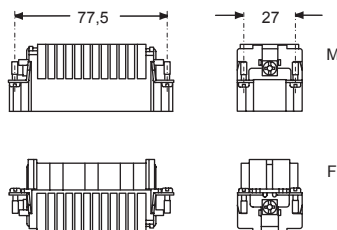
0,14-0,37 mm ²	AWG 26-22	identification No. 1
0,5 mm ²	AWG 20	identification No. 2
0,75 mm ²	AWG 18	identification No. ②
1 mm ²	AWG 18	identification No. 3
1,5 mm ²	AWG 16	identification No. 4
2,5 mm ²	AWG 14	identification No. 5

RDM2D 0.3
RDM2D 0.5
RDM2D 0.7
RDM2D 1.0
RDM2D 1.5
RDM2D 2.5

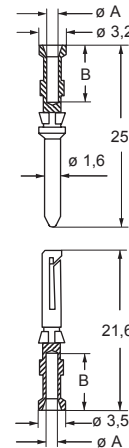
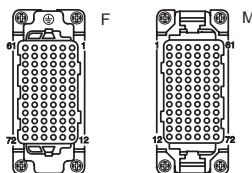
- characteristics according to EN 61984:

10A 250V 4kV 2

- DNV-GL VERITAS ERI certified
- rated voltage according to UL/CSA: 600V
- insulation resistance: ≥ 10 GΩ
- ambient temperature limit: -40 °C ... +125 °C
- made of self-extinguishing thermoplastic resin UL 94V-0
- mechanical life: ≥ 10.000 cycles
- contact resistance: ≤ 3 mΩ
- for applications requiring higher voltages, please see the special voltage application section on page 75
- it is recommended to crimp the contacts with crimping tools homologated by ILME (please see the crimping tool section 10A contacts, RDF2D and RDM2D series) on pages 708 - 741
- PCBs interface, see article CIF 2.4
- for max. current load see the connector inserts derating diagram below; for more information see page 28



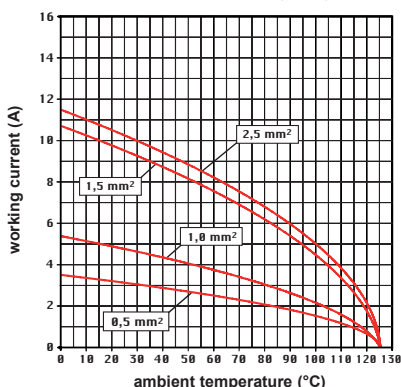
contacts side (front view)



RDF2D and RDM2D contacts

conductor section mm ²	conductor slot ø A (mm)	conductors stripping length B (mm)
0,14-0,37	0,9	8
0,5	1,1	8
0,75	1,3	8
1,0	1,45	8
1,5	1,8	8
2,5	2,2	6

RDD 72 poles connector inserts
Maximum current load derating diagram



CR CP coding pin with loss of one contact (page 689)



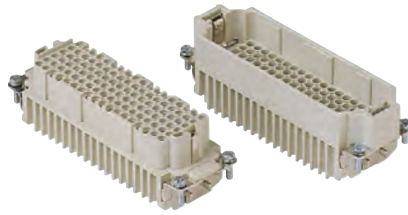
RDD 108 poles + ⊕ 10A - 250V HNM (High Number of Matings)

enclosures:
size "104.27"

page:

HNM 598 - 599
C-TYPE IP65 or IP66/IP69, single lever 412 - 423
V-TYPE IP65 or IP66/IP69, single lever 459 - 463

inserts, crimp connections



10A crimp contacts
gold plated



Q 10.000 MATINGS WITH HNM ENCLOSURES
Q 5.000 MATINGS WITH STANDARD ENCLOSURES, SINGLE LEVER

description	part No.	part No.
-------------	----------	----------

without contacts (to be ordered separately)
female inserts for female contacts
male inserts for male contacts

RDDF 108
RDDM 108

10A female contacts

cross-section	AWG	identification No.
0,14-0,37 mm ²	AWG 26-22	identification No. 1
0,5 mm ²	AWG 20	identification No. 2
0,75 mm ²	AWG 18	identification No. ②
1 mm ²	AWG 18	identification No. 3
1,5 mm ²	AWG 16	identification No. 4
2,5 mm ²	AWG 14	identification No. 5

RDF2D 0.3
RDF2D 0.5
RDF2D 0.7
RDF2D 1.0
RDF2D 1.5
RDF2D 2.5

gold plated

10A male contacts

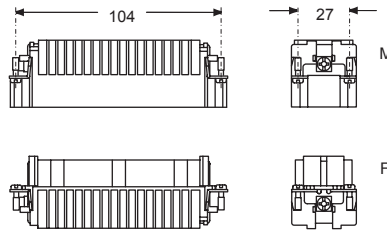
cross-section	AWG	identification No.
0,14-0,37 mm ²	AWG 26-22	identification No. 1
0,5 mm ²	AWG 20	identification No. 2
0,75 mm ²	AWG 18	identification No. ②
1 mm ²	AWG 18	identification No. 3
1,5 mm ²	AWG 16	identification No. 4
2,5 mm ²	AWG 14	identification No. 5

RDM2D 0.3
RDM2D 0.5
RDM2D 0.7
RDM2D 1.0
RDM2D 1.5
RDM2D 2.5

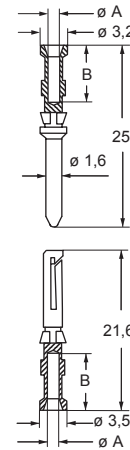
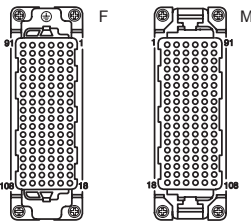
- characteristics according to EN 61984:

10A 250V 4kV 2

- certified
- rated voltage according to UL/CSA: 600V
- insulation resistance: ≥ 10 GΩ
- ambient temperature limit: -40 °C ... +125 °C
- made of self-extinguishing thermoplastic resin UL 94V-0
- mechanical life: ≥ 10.000 cycles
- contact resistance: ≤ 3 mΩ
- for applications requiring higher voltages, please see the special voltage application section on page 75
- **it is recommended to crimp the contacts with crimping tools homologated by ILME** (please see the crimping tool section 10A contacts, RDF2D and RDM2D series) on pages 708 - 741
- PCBs interface, see article CIF 2.4
- for max. current load see the connector inserts derating diagram below; for more information see page 28



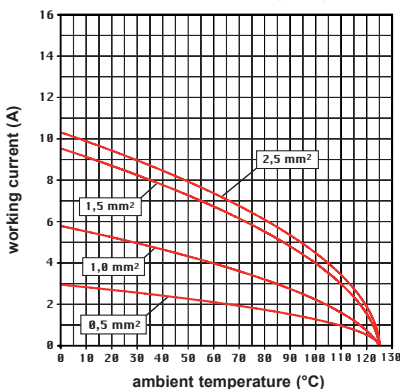
contacts side (front view)



RDF2D and RDM2D contacts

conductor section mm ²	conductor slot ø A (mm)	conductors stripping length B (mm)
0,14-0,37	0,9	8
0,5	1,1	8
0,75	1,3	8
1,0	1,45	8
1,5	1,8	8
2,5	2,2	6

RDD 108 poles connector inserts
Maximum current load derating diagram



CR CP coding pin with loss of one contact (page 689)



RCE 6 poles + ⊕ 16A - 500V HNM (High Number of Matings)

enclosures:
size "44.27"

page:

HNM

592 - 593

inserts, crimp connections



16A crimp contacts
gold plated



Q 10.000 MATINGS WITH HNM ENCLOSURES

description

part No.

part No.

without contacts (to be ordered separately)
female inserts for female contacts
male inserts for male contacts

RCEF 06
RCEM 06

16A female contacts

0,14-0,37 mm ²	AWG 26-22	one groove
0,5 mm ²	AWG 20	with no grooves
0,75 mm ²	AWG 18	one groove (back side)
1 mm ²	AWG 18	one groove
1,5 mm ²	AWG 16	two grooves
2,5 mm ²	AWG 14	three grooves
3 mm ²	AWG 12	one wide groove
4 mm ²	AWG 12	with no grooves

RCF2D 0.3
RCF2D 0.5
RCF2D 0.7
RCF2D 1.0
RCF2D 1.5
RCF2D 2.5
RCF2D 3.0
RCF2D 4.0

gold plated

16A male contacts

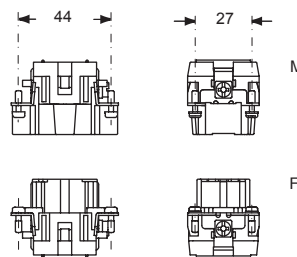
0,14-0,37 mm ²	AWG 26-22	one groove
0,5 mm ²	AWG 20	with no grooves
0,75 mm ²	AWG 18	one groove (back side)
1 mm ²	AWG 18	one groove
1,5 mm ²	AWG 16	two grooves
2,5 mm ²	AWG 14	three grooves
3 mm ²	AWG 12	one wide groove
4 mm ²	AWG 12	with no grooves

RCM2D 0.3
RCM2D 0.5
RCM2D 0.7
RCM2D 1.0
RCM2D 1.5
RCM2D 2.5
RCM2D 3.0
RCM2D 4.0

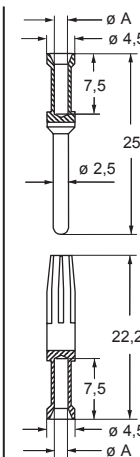
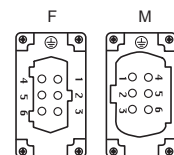
- characteristics according to EN 61984:

16A 500V 6kV 3
16A 400/690V 6kV 2

- certified
- rated voltage according to UL/CSA: 600V
- insulation resistance: ≥ 10 GΩ
- ambient temperature limit: -40 °C ... +125 °C
- made of self-extinguishing thermoplastic resin UL 94V-0
- mechanical life: ≥ 10.000 cycles
- contact resistance: ≤ 1 mΩ
- **it is recommended to crimp the contacts with crimping tools homologated by ILME** (please see the crimping tool section 16A contacts, RCF2D and RCM2D series) on pages 708 - 741
- for max. current load see the connector inserts derating diagram below; for more information see page 28



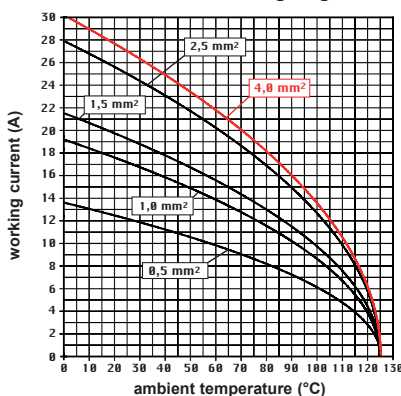
contacts side (front view)



RCF2D and RCM2D contacts

conductor section mm ²	conductor slot ø A (mm)	conductors stripping length (mm)
0,14-0,37	0,9	7,5
0,5	1,1	7,5
0,75	1,3	7,5
1,0	1,45	7,5
1,5	1,8	7,5
2,5	2,2	7,5
3	2,55	7,5
4	2,85	7,5

RCE 06 poles connector inserts
Maximum current load derating diagram



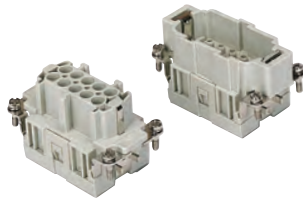
RCE 10 poles + ⊕ 16A - 500V HNM (High Number of Matings)

enclosures:
size "57.27"

page:

HNM 594 - 595
C-TYPE IP65 or IP66/IP69, single lever 393 - 401
V-TYPE IP65 or IP66/IP69, single lever 448 - 453

inserts, crimp connections



Q 10.000 MATINGS WITH HNM ENCLOSURES
Q 5.000 MATINGS WITH STANDARD ENCLOSURES, SINGLE LEVER

16A crimp contacts
gold plated



description	part No.	part No.
-------------	----------	----------

without contacts (to be ordered separately)
female inserts for female contacts
male inserts for male contacts

RCEF 10
RCEM 10

16A female contacts

Area (mm²)	AWG	Configuration
0,14-0,37	26-22	one groove
0,5	20	with no grooves
0,75	18	one groove (back side)
1	18	one groove
1,5	16	two grooves
2,5	14	three grooves
3	12	one wide groove
4	12	with no grooves

RCF2D 0.3
RCF2D 0.5
RCF2D 0.7
RCF2D 1.0
RCF2D 1.5
RCF2D 2.5
RCF2D 3.0
RCF2D 4.0

gold plated

16A male contacts

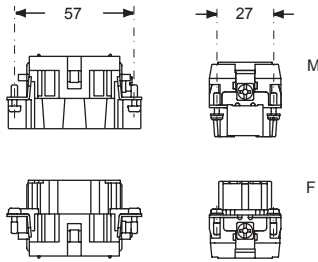
Area (mm²)	AWG	Configuration
0,14-0,37	26-22	one groove
0,5	20	with no grooves
0,75	18	one groove (back side)
1	18	one groove
1,5	16	two grooves
2,5	14	three grooves
3	12	one wide groove
4	12	with no grooves

RCM2D 0.3
RCM2D 0.5
RCM2D 0.7
RCM2D 1.0
RCM2D 1.5
RCM2D 2.5
RCM2D 3.0
RCM2D 4.0

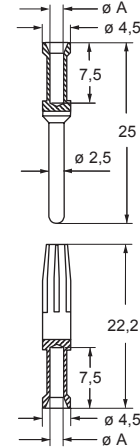
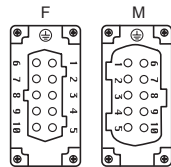
- characteristics according to EN 61984:

16A 500V 6kV 3
16A 400/690V 6kV 2

- certified
- rated voltage according to UL/CSA: 600V
- insulation resistance: ≥ 10 GΩ
- ambient temperature limit: -40 °C ... +125 °C
- made of self-extinguishing thermoplastic resin UL 94V-0
- mechanical life: ≥ 10.000 cycles
- contact resistance: ≤ 1 mΩ
- **it is recommended to crimp the contacts with crimping tools homologated by ILME** (please see the crimping tool section 16A contacts, RCF2D and RCM2D series) on pages 708 - 741
- for max. current load see the connector inserts derating diagram below; for more information see page 28



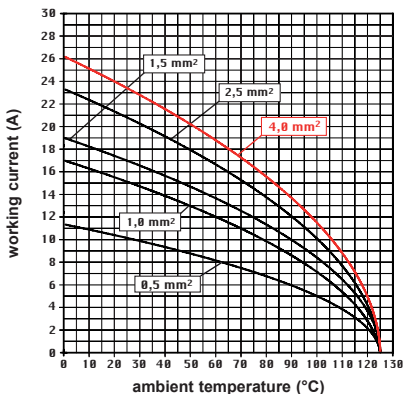
contacts side (front view)



RCF2D and RCM2D contacts

conductor section mm²	conductor slot ø A (mm)	conductors stripping length (mm)
0,14-0,37	0,9	7,5
0,5	1,1	7,5
0,75	1,3	7,5
1,0	1,45	7,5
1,5	1,8	7,5
2,5	2,2	7,5
3	2,55	7,5
4	2,85	7,5

RCE 10 poles connector inserts
Maximum current load derating diagram



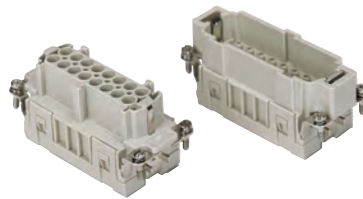
RCE 16 poles + ⊕ 16A - 500V HNM (High Number of Matings)

enclosures:
size "77.27"

page:

HNM 596 - 597
C-TYPE IP65 or IP66/IP69, single lever 402 - 411
V-TYPE IP65 or IP66/IP69, single lever 454 - 458

inserts, crimp connections



Q 10.000 MATINGS WITH HNM ENCLOSURES

Q 5.000 MATINGS WITH STANDARD ENCLOSURES, SINGLE LEVER

16A crimp contacts
gold plated



description

part No.

part No.

without contacts (to be ordered separately)
female inserts for female contacts
male inserts for male contacts

RCEF 16
RCEM 16

16A female contacts

0,14-0,37 mm ²	AWG 26-22	one groove
0,5 mm ²	AWG 20	with no grooves
0,75 mm ²	AWG 18	one groove (back side)
1 mm ²	AWG 18	one groove
1,5 mm ²	AWG 16	two grooves
2,5 mm ²	AWG 14	three grooves
3 mm ²	AWG 12	one wide groove
4 mm ²	AWG 12	with no grooves

RCF2D 0.3
RCF2D 0.5
RCF2D 0.7
RCF2D 1.0
RCF2D 1.5
RCF2D 2.5
RCF2D 3.0
RCF2D 4.0

gold plated

16A male contacts

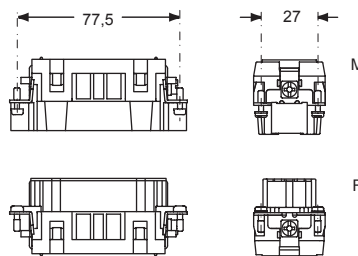
0,14-0,37 mm ²	AWG 26-22	one groove
0,5 mm ²	AWG 20	with no grooves
0,75 mm ²	AWG 18	one groove (back side)
1 mm ²	AWG 18	one groove
1,5 mm ²	AWG 16	two grooves
2,5 mm ²	AWG 14	three grooves
3 mm ²	AWG 12	one wide groove
4 mm ²	AWG 12	with no grooves

RCEM2D 0.3
RCEM2D 0.5
RCEM2D 0.7
RCEM2D 1.0
RCEM2D 1.5
RCEM2D 2.5
RCEM2D 3.0
RCEM2D 4.0

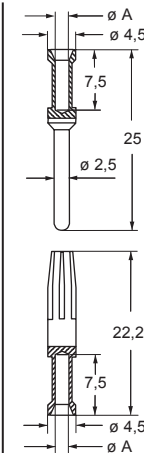
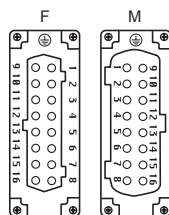
- characteristics according to EN 61984:

16A 500V 6kV 3
16A 400/690V 6kV 2

- DNV-GL, VERITAS, ENEC certified
- rated voltage according to UL/CSA: 600V
- insulation resistance: ≥ 10 GΩ
- ambient temperature limit: -40 °C ... +125 °C
- made of self-extinguishing thermoplastic resin UL 94V-0
- mechanical life: ≥ 10.000 cycles
- contact resistance: ≤ 1 mΩ
- it is recommended to crimp the contacts with crimping tools homologated by ILME (please see the crimping tool section 16A contacts, RCF2D and RCEM2D series) on pages 708 - 741
- for max. current load see the connector inserts derating diagram below; for more information see page 28



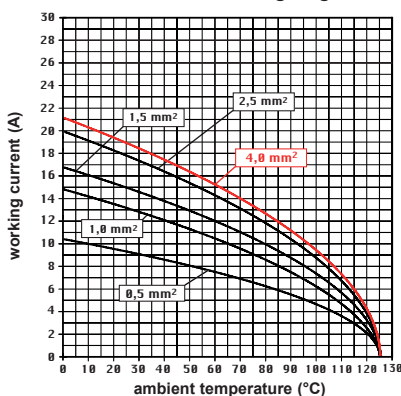
contacts side (front view)



RCF2D and RCEM2D contacts

conductor section mm ²	conductor slot ø A (mm)	conductors stripping length (mm)
0,14-0,37	0,9	7,5
0,5	1,1	7,5
0,75	1,3	7,5
1,0	1,45	7,5
1,5	1,8	7,5
2,5	2,2	7,5
3	2,55	7,5
4	2,85	7,5

RCE 16 poles connector inserts
Maximum current load derating diagram



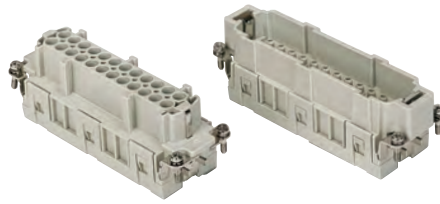
RCE 24 poles + ⊕ 16A - 500V HNM (High Number of Matings)

enclosures:
size "104.27"

page:

HNM 598 - 599
C-TYPE IP65 or IP66/IP69, single lever 412 - 423
V-TYPE IP65 or IP66/IP69, single lever 459 - 463

inserts, crimp connections



Q 10.000 MATINGS WITH HNM ENCLOSURES
Q 5.000 MATINGS WITH STANDARD ENCLOSURES, SINGLE LEVER

16A crimp contacts
gold plated



description	part No.	part No.
-------------	----------	----------

without contacts (to be ordered separately)
female inserts for female contacts
male inserts for male contacts

RCEF 24
RCEM 24

16A female contacts

Area (mm ²)	AWG	Configuration
0,14-0,37	26-22	one groove
0,5	20	with no grooves
0,75	18	one groove (back side)
1	18	one groove
1,5	16	two grooves
2,5	14	three grooves
3	12	one wide groove
4	12	with no grooves

RCF2D 0.3
RCF2D 0.5
RCF2D 0.7
RCF2D 1.0
RCF2D 1.5
RCF2D 2.5
RCF2D 3.0
RCF2D 4.0

gold plated

16A male contacts

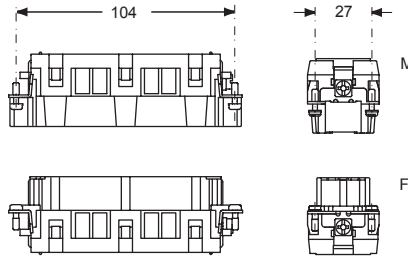
Area (mm ²)	AWG	Configuration
0,14-0,37	26-22	one groove
0,5	20	with no grooves
0,75	18	one groove (back side)
1	18	one groove
1,5	16	two grooves
2,5	14	three grooves
3	12	one wide groove
4	12	with no grooves

RCM2D 0.3
RCM2D 0.5
RCM2D 0.7
RCM2D 1.0
RCM2D 1.5
RCM2D 2.5
RCM2D 3.0
RCM2D 4.0

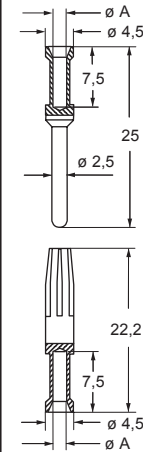
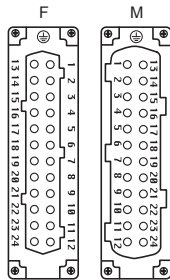
- characteristics according to EN 61984:

16A 500V 6kV 3
16A 400/690V 6kV 2

- certified
- rated voltage according to UL/CSA: 600V
- insulation resistance: $\geq 10 \text{ G}\Omega$
- ambient temperature limit: $-40 \text{ }^\circ\text{C} \dots +125 \text{ }^\circ\text{C}$
- made of self-extinguishing thermoplastic resin UL 94V-0
- mechanical life: ≥ 10.000 cycles
- contact resistance: $\leq 1 \text{ m}\Omega$
- **it is recommended to crimp the contacts with crimping tools homologated by ILME** (please see the crimping tool section 16A contacts, RCF2D and RCM2D series) on pages 708 - 741
- for max. current load see the connector inserts derating diagram below; for more information see page 28



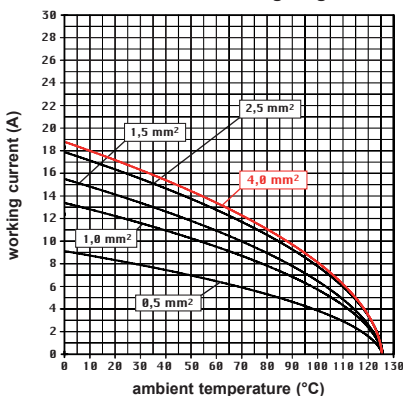
contacts side (front view)



RCF2D and RCM2D contacts

conductor section mm ²	conductor slot ø A (mm)	conductors stripping length (mm)
0,14-0,37	0,9	7,5
0,5	1,1	7,5
0,75	1,3	7,5
1,0	1,45	7,5
1,5	1,8	7,5
2,5	2,2	7,5
3	2,55	7,5
4	2,85	7,5

RCE 24 poles connector inserts
Maximum current load derating diagram



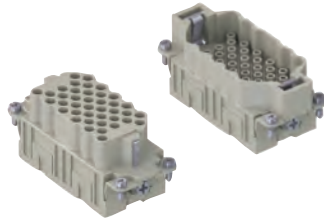
RQEE 40 poles + ⊕ 16A - 500V HNM (High Number of Matings)

enclosures:
size "77.27"

page:

HNM 596 - 597
C-TYPE IP65 or IP66/IP69, single lever 402 - 411
V-TYPE IP65 or IP66/IP69, single lever 454 - 458

inserts, crimp connections



Q 10.000 MATINGS WITH HNM ENCLOSURES

Q 5.000 MATINGS WITH STANDARD ENCLOSURES, SINGLE LEVER

16A crimp contacts
gold plated



description

part No.

part No.

without contacts (to be ordered separately)
female inserts for female contacts
male inserts for male contacts

RQEEF 40
RQEEM 40

16A female contacts

0,14-0,37 mm ²	AWG 26-22	one groove
0,5 mm ²	AWG 20	with no grooves
0,75 mm ²	AWG 18	one groove (back side)
1 mm ²	AWG 18	one groove
1,5 mm ²	AWG 16	two grooves
2,5 mm ²	AWG 14	three grooves
3 mm ²	AWG 12	one wide groove
4 mm ²	AWG 12	with no grooves

RCF2D 0.3
RCF2D 0.5
RCF2D 0.7
RCF2D 1.0
RCF2D 1.5
RCF2D 2.5
RCF2D 3.0
RCF2D 4.0

gold plated

16A male contacts

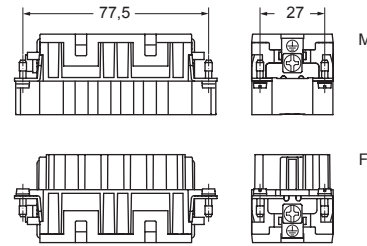
0,14-0,37 mm ²	AWG 26-22	one groove
0,5 mm ²	AWG 20	with no grooves
0,75 mm ²	AWG 18	one groove (back side)
1 mm ²	AWG 18	one groove
1,5 mm ²	AWG 16	two grooves
2,5 mm ²	AWG 14	three grooves
3 mm ²	AWG 12	one wide groove
4 mm ²	AWG 12	with no grooves

RCM2D 0.3
RCM2D 0.5
RCM2D 0.7
RCM2D 1.0
RCM2D 1.5
RCM2D 2.5
RCM2D 3.0
RCM2D 4.0

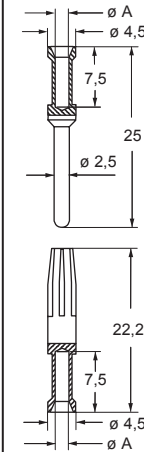
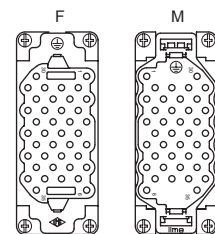
- characteristics according to EN 61984:

16A 500V 6kV 3

- DNV-GL VERITAS EAC certified
- rated voltage according to UL/CSA: 600V
- insulation resistance: ≥ 10 GΩ
- ambient temperature limit: -40 °C ... +125 °C
- made of self-extinguishing thermoplastic resin UL 94V-0
- mechanical life: ≥ 10.000 cycles
- contact resistance: ≤ 1 mΩ
- it is recommended to crimp the contacts with crimping tools homologated by ILME (please see the crimping tool section 16A contacts, RCF2D and RCM2D series) on pages 708 - 741
- for max. current load see the connector inserts derating diagram below; for more information see page 28



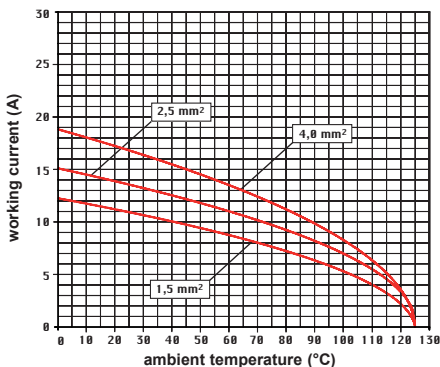
contacts side (front view)



RCF2D and RCM2D contacts

conductor section mm ²	conductor slot ø A (mm)	conductors stripping length (mm)
0,14-0,37	0,9	7,5
0,5	1,1	7,5
0,75	1,3	7,5
1,0	1,45	7,5
1,5	1,8	7,5
2,5	2,2	7,5
3	2,55	7,5
4	2,85	7,5

RQEE 40 poles connector inserts
Maximum current load derating diagram



CR CPQ coding pins
[page 689]



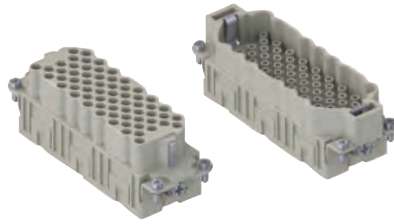
RQEE 64 poles + ⊕ 16A - 500V HNM (High Number of Matings)

enclosures:
size "104.27"

page:

HNM 598 - 599
C-TYPE IP65 or IP66/IP69, single lever 412 - 423
V-TYPE IP65 or IP66/IP69, single lever 459 - 463

inserts, crimp connections



Q 10.000 MATINGS WITH HNM ENCLOSURES

Q 5.000 MATINGS WITH STANDARD ENCLOSURES, SINGLE LEVER

16A crimp contacts
gold plated



description	part No.	part No.
-------------	----------	----------

without contacts (to be ordered separately)
female inserts for female contacts
male inserts for male contacts

RQEEF 64
RQEEM 64

16A female contacts

Area (mm ²)	AWG	Configuration
0,14-0,37	26-22	one groove
0,5	20	with no grooves
0,75	18	one groove (back side)
1	18	one groove
1,5	16	two grooves
2,5	14	three grooves
3	12	one wide groove
4	12	with no grooves

RCF2D 0.3
RCF2D 0.5
RCF2D 0.7
RCF2D 1.0
RCF2D 1.5
RCF2D 2.5
RCF2D 3.0
RCF2D 4.0

gold plated

16A male contacts

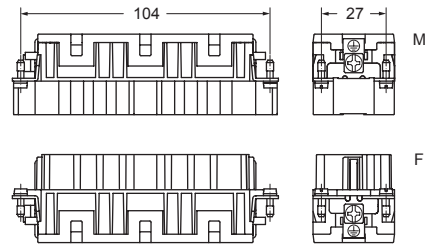
Area (mm ²)	AWG	Configuration
0,14-0,37	26-22	one groove
0,5	20	with no grooves
0,75	18	one groove (back side)
1	18	one groove
1,5	16	two grooves
2,5	14	three grooves
3	12	one wide groove
4	12	with no grooves

RCM2D 0.3
RCM2D 0.5
RCM2D 0.7
RCM2D 1.0
RCM2D 1.5
RCM2D 2.5
RCM2D 3.0
RCM2D 4.0

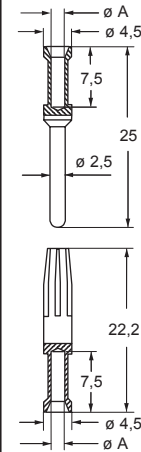
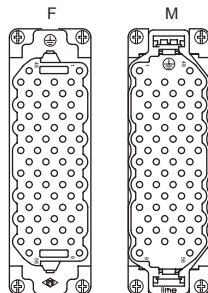
- characteristics according to EN 61984:

16A 500V 6kV 3

- certified
- rated voltage according to UL/CSA: 600V
- insulation resistance: ≥ 10 GΩ
- ambient temperature limit: -40 °C ... +125 °C
- made of self-extinguishing thermoplastic resin UL 94V-0
- mechanical life: ≥ 10.000 cycles
- contact resistance: ≤ 1 mΩ
- **it is recommended to crimp the contacts with crimping tools homologated by ILME** (please see the crimping tool section 16A contacts, RCF2D and RCM2D series) on pages 708 - 741
- for max. current load see the connector inserts derating diagram below; for more information see page 28



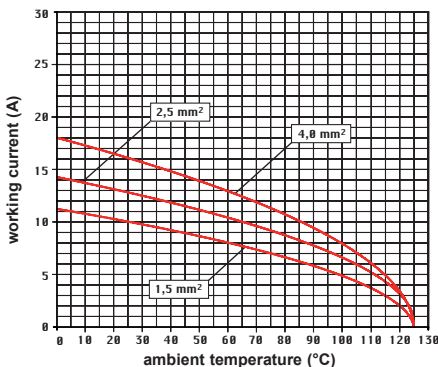
contacts side (front view)



RCF2D and RCM2D contacts

conductor section mm ²	conductor slot ø A (mm)	conductors stripping length (mm)
0,14-0,37	0,9	7,5
0,5	1,1	7,5
0,75	1,3	7,5
1,0	1,45	7,5
1,5	1,8	7,5
2,5	2,2	7,5
3	2,55	7,5
4	2,85	7,5

RQEE 64 poles connector inserts
Maximum current load derating diagram



CR CPQ coding pins
(page 689)

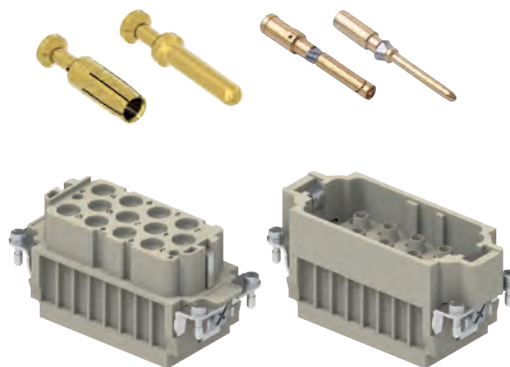


RXF/M 12/2

TECHNICAL FEATURES

Special **HNM** version (**High Number of Matings** up to 10.000 cycles) of CXF/M 12/2 connector inserts, to be used in combination with:

- **up to 12 40A HNM gold plated removable crimp contacts** of the **new RX** series,
 - **2 10A HNM gold plated removable crimp contacts** of the **already available RD** series;
- crimp connector inserts with a combination of 12 power contacts (40A) plus 2 auxiliary contacts (10A) + PE;
 - suitable for the operation of 4 three-phase AC motors with 2 auxiliary contacts;
 - featuring a special antifriction treatment to guarantee up to **10.000 mating cycles**
 - **5.000 mating cycles** with standard enclosures, single lever (excluding size "44.27").



SUM-UP

- ☑ **Crimp connection**
- ☑ **Great resistance to strong vibrations**
- ☑ **For wires: up to 10 mm² (AWG 8)**
- ☑ **Auxiliary crimp contacts: HNM gold plated**

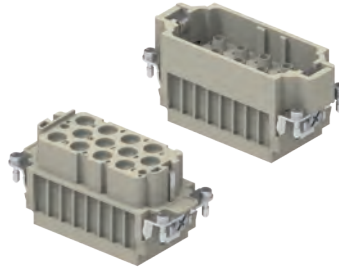


enclosures:
size "77.27"

page:

HNM 596 - 597
C-TYPE IP65 or IP66/IP69, single lever 402 - 411
V-TYPE IP65 or IP66/IP69, single lever 454 - 458

inserts, crimp connections



Q 10.000 MATINGS WITH HNM ENCLOSURES
Q 5.000 MATINGS WITH STANDARD ENCLOSURES, SINGLE LEVER

40A and 10A crimp contacts
gold plated



description	part No.	part No
-------------	----------	---------

without contacts (to be ordered separately)
female inserts for female contacts
male inserts for male contacts

RXF 12/2
RXM 12/2

40A female crimp contacts
1,5 mm² AWG 16
2,5 mm² AWG 14
4 mm² AWG 12
6 mm² AWG 10

RXF2D 1.5
RXF2D 2.5
RXF2D 4.0
RXF2D 6.0

gold plated

40A male crimp contacts
1,5 mm² AWG 16
2,5 mm² AWG 14
4 mm² AWG 12
6 mm² AWG 10

RXM2D 1.5
RXM2D 2.5
RXM2D 4.0
RXM2D 6.0

10A female contacts

0,14-0,37 mm² AWG 26-22 identification No. 1
0,5 mm² AWG 20 identification No. 2
0,75 mm² AWG 18 identification No. ②
1 mm² AWG 18 identification No. 3
1,5 mm² AWG 16 identification No. 4
2,5 mm² AWG 14 identification No. 5

RDF2D 0.3
RDF2D 0.5
RDF2D 0.7
RDF2D 1.0
RDF2D 1.5
RDF2D 2.5

gold plated

10A male contacts

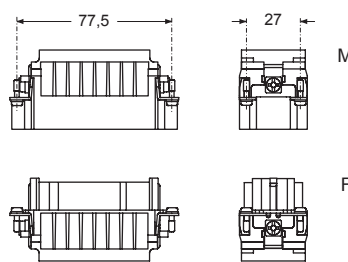
0,14-0,37 mm² AWG 26-22 identification No. 1
0,5 mm² AWG 20 identification No. 2
0,75 mm² AWG 18 identification No. ②
1 mm² AWG 18 identification No. 3
1,5 mm² AWG 16 identification No. 4
2,5 mm² AWG 14 identification No. 5

RDM2D 0.3
RDM2D 0.5
RDM2D 0.7
RDM2D 1.0
RDM2D 1.5
RDM2D 2.5

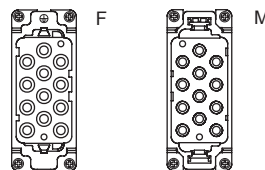
- characteristics according to EN 61984:

40A 690V 8kV 3
10A 250V 4kV 3

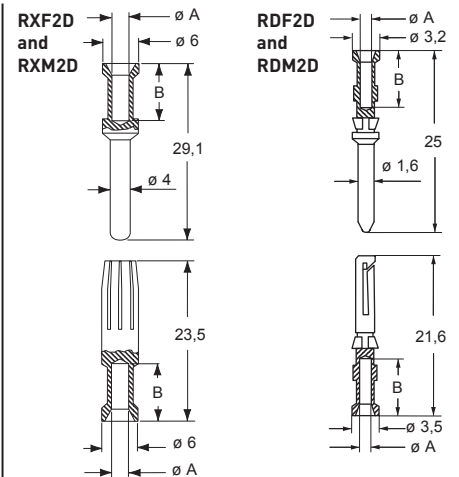
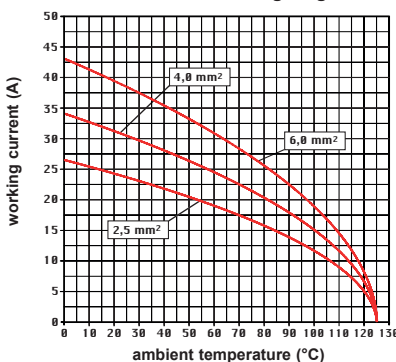
- cURus, CSA, CQC, DNV-GL, BV, EAC pending
- rated voltage according to UL/CSA: 600V
- insulation resistance: ≥ 10 GΩ
- ambient temperature limit: -40 °C ... +125 °C
- made of self-extinguishing thermoplastic resin UL 94V-0
- mechanical life: ≥ 10.000 cycles
- contact resistance: ≤ 0,3 mΩ (12 poles), ≤ 1 mΩ (2 poles)
- for max. current load see the connector inserts derating diagram below; for more information see page 28



contacts side (front view)



RX 12/2 power poles connector inserts
Maximum current load derating diagram



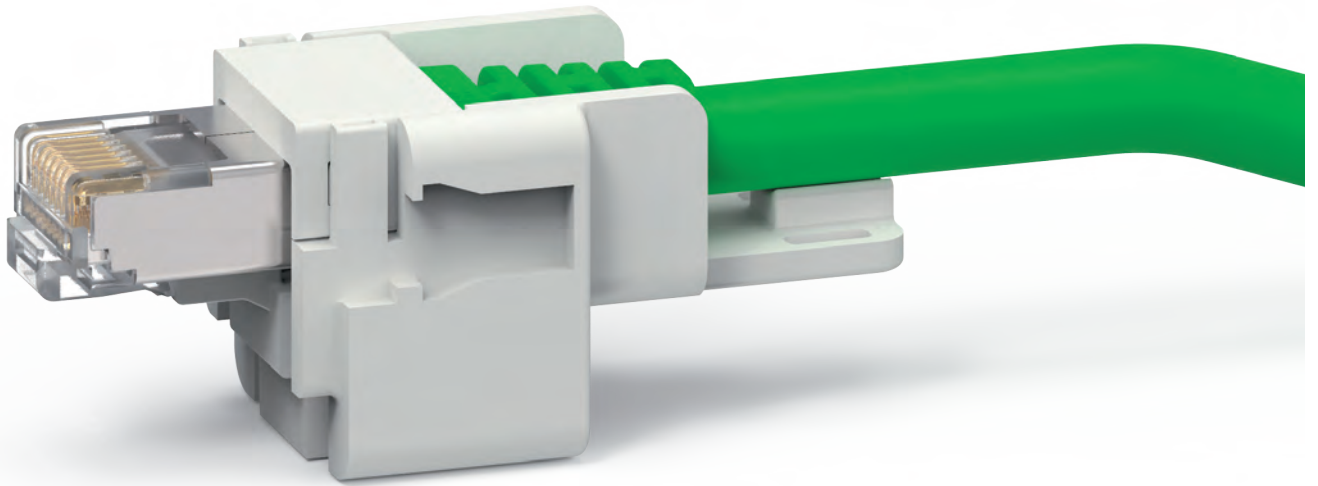
RXF2D and RXM2D contacts

conductor cross-sectional area mm ²	conductor slot Ø A (mm)	conductor stripping length B (mm)
1,5	1,8	9
2,5	2,2	9
4	2,85	9,6
6	3,5	9,6

RDF2D and RDM2D contacts

conductor cross-sectional area mm ²	conductor slot Ø A (mm)	conductor stripping length B (mm)
0,14-0,37	0,9	8
0,5	1,1	8
0,75	1,3	8
1,0	1,45	8
1,5	1,8	8
2,5	2,2	6

- it is recommended to crimp the contacts with crimping tools homologated by ILME (please see the crimping tool section 40A contacts, RXF2D, RXM2D series and 10A contacts RDF2D, RDM2D series) on pages 708 - 741



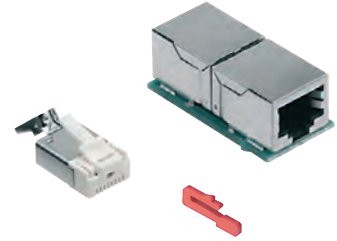
CJ RJ45 connector

enclosures: size "21.21"	page:
insulating type (CK IN, CKG/MKG VN/VAN)	346 - 348
metallic type (CKAX I, CKAG/MKAG V/VA) (MKAX/MKA/MKAXX IF)	353 - 355 362 - 363
IP68 (CGK I, CGK/MGK V)	628 - 631

adaptor for RJ45 connectors



RJ45 connectors



description	part No.	part No. data contacts only	part No. data contacts/+2 power contacts
without RJ45 connector (to be ordered separately) adapter for RJ45 female connector in fixed enclosures	CJ KF		
RJ45 coupler jack with 8 data contacts ¹⁾		CX 8 JF	
RJ45 coupler jack with 8 data contacts/2 power contacts ¹⁾			CX 8/2 JF
without RJ45 connector (to be ordered separately) adapter for RJ45 male connector ²⁾	CJ KM		
RJ45 plug with 4 data contacts		CX 4 JM	
RJ45 plug with 4 data contacts/2 power contacts			CX 4/2 JM
RJ45 plug with 6 data contacts/2 power contacts			CX 6/2 JM
RJ45 plug with 8 data contacts		CX 8 JM	
RJ45 plug, 4 data contacts cat. 5e ProfiNET®		CX 4E JM	

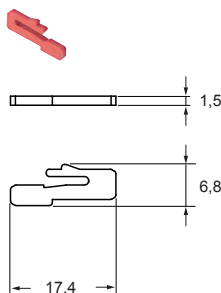
¹⁾ 4-pole version on request, part No. **CX 4 JF** and **CX 4/2 JF** with "crossover" link

²⁾ to be used with hoods

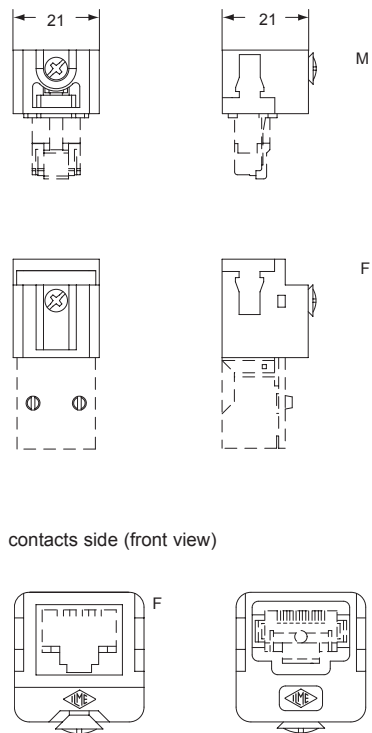
RJ45 connector features:

- RJ45 insert, Class 5 Ethernet
- rated current: 2,1A at 70 °C
- rated voltage: 50VDC / 35VAC
- IDC terminals:
- for 0,22 mm² (AWG 24/7) data contacts **CX 4 JM**
- for 0,14 mm² (AWG 26/7) or 0,22 mm² (AWG 24/7) data contacts **CX 4/2 JM**
- for 0,34 mm² (AWG 22/7) or 0,38 mm² (AWG 22/19) power contacts
- for 0,14 mm² (AWG 26/7) data contacts **CX 6/2 JM**
- for 0,25 mm² (AWG 23/19) power contacts
- for 0,14 mm² (AWG 26/7) data contacts **CX 8 JM**
- for 0,34 mm² (AWG 22/7) data contacts **CX 4E JM**
- /7 = 7-strands wire
- /19 = 19-strands wire
- Ø_{max} insulating conductors 1 mm (data), 1,4 mm (power and CX 4E JM)
- Ø_{max} complete cable 7 mm (CX 8 JM: 6,9 mm)
- temperature range: from -40°C to 120 °C
- nickel plated brass screening
- insert coding pin for RJ45 adapters (optional)*: **CR KC**
- * Optional four coding positions CR KC insert coding pin (4 pins required for each connector coupling).
- self-extinguishing properties: to UL 94V-0
- crimp pliers: **CJPZ Y**
- screened cable stripper: **CJST**
- for crimping a male connector, see the crimp tool section page 735
- **us** (UL for USA and Canada) certified

CR KC insert coding pin



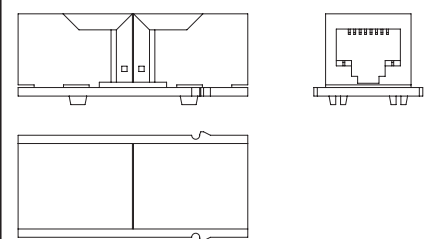
CJ KF, CJ KM



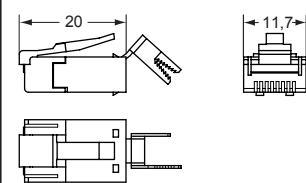
contacts side (front view)

inserts already supplied with stainless steel fixing screw with gasket, which ensures IP66/IP67/IP69 degree of protection

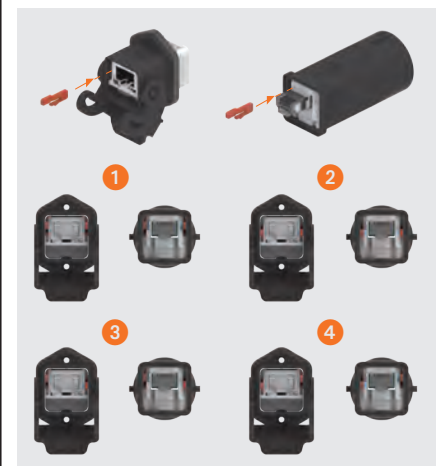
CX 4 JF, CX 4/2 JF, CX 8 JF, CX 8/2 JF



CX 4 JM, CX 4E JM, CX 4/2 JM, CX 6/2 JM, CX 8 JM



How to use CR KC coding pins (cannot be used with IP68 enclosures)



CJZ RJ45 connector

- IP66/IP67/IP69 degree of protection (EN 60529)
- insert RJ45, CAT. 5 Ethernet
- rated current: 2.1A at 70 °C
- rated voltage: 50V DC / 35V AC
- temperature limit: -40 °C, +120 °C
- nickel-plated brass screening
- insert coding pin: **CR KC**
- self-extinguishing: UL 94V-0
- insulating enclosures in black self-extinguishing thermoplastic material
- hoods with cable gland
- female insert with two connected entries

IP66 / IP67 connector in bulkhead housing, female inserts

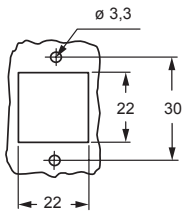


patch cord with 2 RJ45 connectors, male inserts

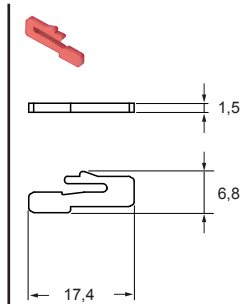


description	part No.	part No.	(L) metre
connector in insulating enclosure and insert with 8 data contacts	CJZ 8 IN		
connector in metal enclosure and insert with 8 data contacts	CJZA 8 I		
RJ45 connector 8 data contacts, in insulating enclosure		CWK 2 J2M8	2
		CWK 5 J2M8	5
		CWK 10 J2M8	10
RJ45 connector 8 data contacts, in metal enclosure		CWKA 2 J2M8	2
		CWKA 5 J2M8	5
		CWKA 10 J2M8	10

panel cut-out for bulkhead mounting housings



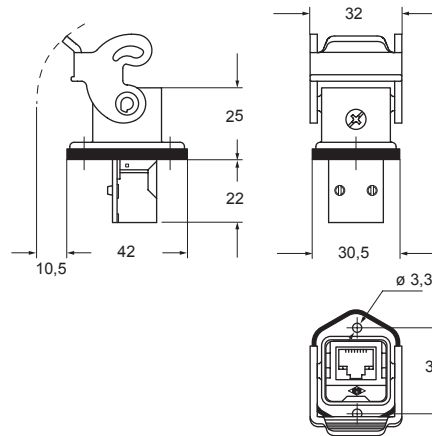
CR KC
insert coding pin



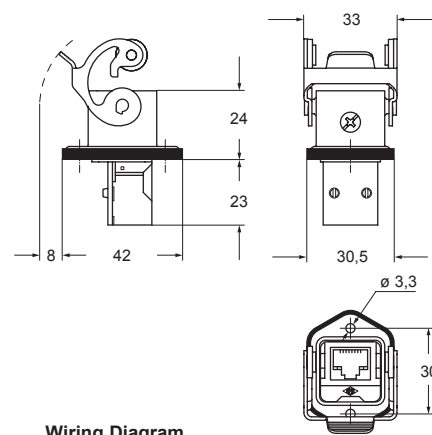
How to use CR KC coding pins
(cannot be used with IP68 enclosures)



CJZ IN



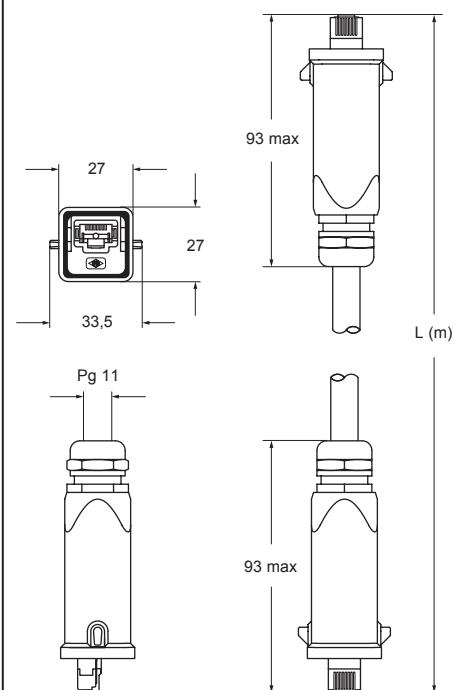
CJZA I



Wiring Diagram

1	1
2	2
3	3
4	4
5	5
6	6
7	7
8	8
VS	VS

CWK J2M8 and CWKA J2M8



Wiring Diagram

1	1
2	2
3	3
4	4
5	5
6	6
7	7
8	8
VS	VS

CYG RJ45 connector

Allows two complete portable RJ45 connectors to be joined, IP65/IP67/IP69 version

insulated version coupling, for RJ45 connectors



metal version coupling, for RJ45 connectors

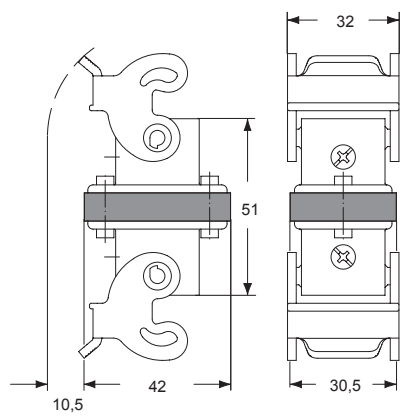


description	part No. data contacts only	part No. data contacts/+2 power contacts	part No. data contacts only	part No. data contacts/+2 power contacts
RJ45 coupler jack within housings, 8 data contacts ¹⁾ RJ45 coupler jack within housings, 8 data contacts/2 power contacts ¹⁾	CYG 8 JF	CYG 8/2 JF		
RJ45 coupler jack within housings, 8 data contacts ²⁾ RJ45 coupler jack within housings, 8 data contacts/2 power contacts ²⁾			CYG 8 JFA	CYG 8/2 JFA

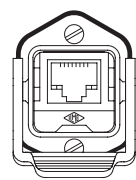
¹⁾ 4-pole version on request, part No. **CYG 4 JF** and **CYG 4/2 JF** with "crossover" link
²⁾ 4-pole version on request, part No. **CYG 4 JFA** and **CYG 4/2 JFA** with "crossover" link

- RJ45 connector features:**
- RJ45, Class 5 connector
 - nominal current: 2.1A at 70 °C
 - nominal voltage: 50VDC / 35VAC
 - temperature range: from -40 °C to +120 °C
 - nickel plated brass screening
 - insert coding pin: **CR KC**
 - self-extinguishing properties: UL 94V-0
 - die cast zinc alloy metal enclosures
 - black self-extinguishing thermoplastic insulated enclosures.

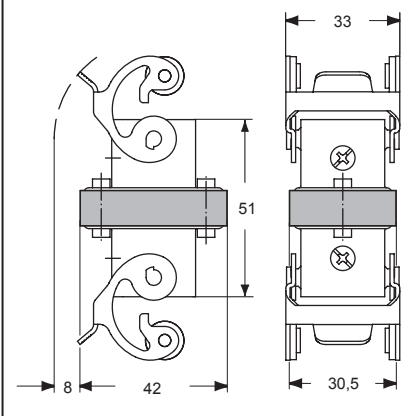
CYG 4 JF, CYG 4/2 JF, CYG 8 JF, CYG 8/2 JF



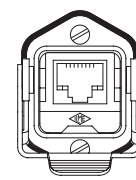
contacts side (front view)



CYG 4 JFA, CYG 4/2 JFA, CYG 8 JFA, CYG 8/2 JFA



contacts side (front view)



DATA CONNECTORS

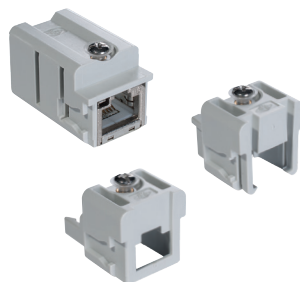
CJK adapters 1 seat for RJ45 connector Cat. 6 Class E_A

enclosures: size "21.21"	page:
insulating type (CK IN, CKG/MKG VN/VAN *)	346 - 348
metallic type (CKAX I, CKAX/MKAX IAP/AP/VG) (CKAG/MKAG V/VA *) (MKAX/MKA/MKAXX IF)	349 and 353 354 - 355 362 - 363
IP68 (CGK I, CGK/MGK IAP, CGK/MGK V)	628 - 631

*) angled enclosures cannot be used with CX 8 J6IM

- characteristics according to EN 61984:
1A 50V 0,8kV 3
- cULus (UL for USA and Canada) certified
- insulation resistance: ≥ 10 G Ω
- made of self-extinguishing thermoplastic resin UL 94V-0
- mechanical life: ≥ 500 cycles
- temperature range: from -40 °C to +70 °C
- we recommend to fix the cable with cable tie

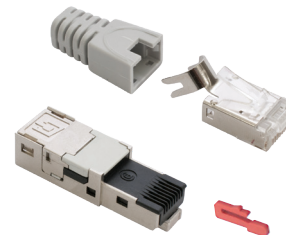
adapters for RJ45 male connectors,
RJ45 female-female connectors



RJ45 male connectors,
crimp and IDC termination



Watch
our CX 8 J6M
online tutorial



Watch
our CX 8 J6IM
online tutorial

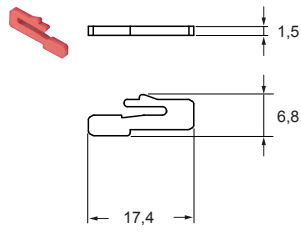
description	part No.	part No.
socket insert with 1 RJ45 female connector plug inserts for 1 RJ45 male crimp connector, 8 data contacts (without RJ45 connector, to be ordered separately)	CJK 8FT CJK 8MT	
plug insert for 1 RJ45 male IDC connector, 8 data contacts (without RJ45 connector, to be ordered separately)	CJK 8IMT	
RJ45 male crimp connector, 8 data contacts		CX 8 J6M
RJ45 male IDC connector, 8 data contacts		CX 8 J6IM

- CJK 8FT technical data:**
- RJ45 female insert, Cat. 6 Class E_A
 - shielding housing: zinc diecast
 - housing finish: nickel-plated
 - current carrying capacity at 50 °C: 1A
 - adequate for Power over Ethernet: PoE according to IEEE 802.3af
 - connectors: IEC 60603-7-5
 - adequate for 10 Gigabit Ethernet: 10 Gigabit Ethernet acc. to IEEE 802.3an
 - custom-designed cabling systems: PROFINET Installation Guideline
 - generic cabling systems: ANSI/TIA/EIA-568-C.2
 - ISO/IEC 11801
 - EN50173-1
 - ISO/IEC 24702
 - EN 61918
 - class E_A (channel): ISO/IEC 11801, EN 50173-1

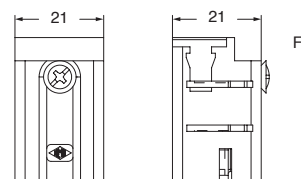
- CX 8 J6M technical data:**
- RJ45 male crimp connectors Cat. 6_A
 - crimp pliers: **CJPZ T**
 - screened cable stripper: **CJST**
 - Cu-conductor diameter
solid: 0,40 - 0,51 mm (AWG 26/1 - 24/1)
stranded: 0,46 - 0,61 mm (AWG 27/7 - 24/7)
 - insulation diameter: 0,85 - 1,05 mm
 - cable diameter: 5,0 - 7,0 mm
 - connectors: IEC 60603-7-51
 - 10 Gigabit Ethernet acc. to IEEE 802.3an: adequate for 10 Gigabit Ethernet
 - category 6_A: ISO/IEC 11801; EN 50173-1
 - class E_A: ISO/IEC 11801; EN 50173-1
 - category 6_A: ANSI/TIA/EIA-568-C.2

- CX 8 J6IM technical data:**
- RJ45 male IDC connectors Cat. 6 Class E_A
 - Cu-conductor diameter
solid: 0,41 - 0,64 mm (AWG 26/1 - 22/1)
stranded: 0,48 - 0,76 mm (AWG 26/7 - 22/7)
 - insulation diameter: 0,85 - 1,6 mm
 - cable diameter: 5,5 - 8,5 mm
 - connectors: IEC 60603-7-5
 - category 6_A: ISO/IEC 11801; DIN EN 50173-1
 - wrenches pliers for CX 8 J6IM: **CJPW K**
 - 10 Gigabit Ethernet acc. to IEEE 802.3an: adequate for 10 Gigabit Ethernet
 - class E_A: ISO/IEC 11801; EN 50173-1
 - category 6: ANSI/TIA/EIA-568-C.2
 - custom-designed cabling systems: according to PROFINET Installation Guideline

CR KC
insert coding pin



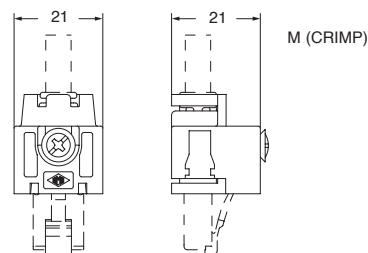
CJK 8FT



Female-Female

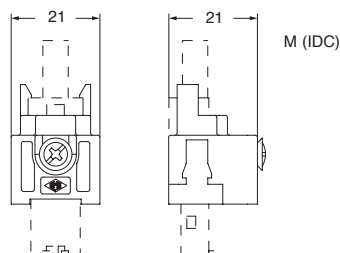


CJK 8MT¹⁾



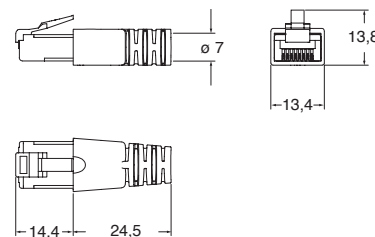
¹⁾ to be used with hoods

CJK 8IMT¹⁾

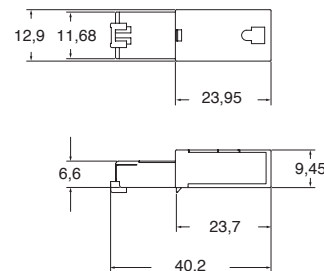


¹⁾ to be used with hoods

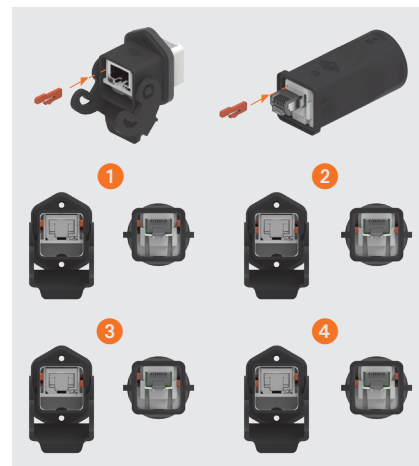
CX 8 J6M (can be used with CJK 8MT)



CX 8 J6IM (can be used with CJK 8IMT)

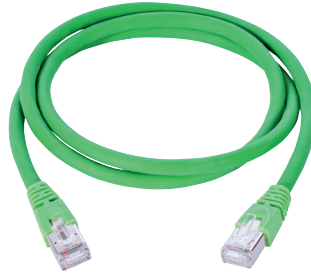


How to use CR KC coding pins
(cannot be used with IP68 enclosures)



CW RJ45 patch cord

with 2 RJ45 male connectors

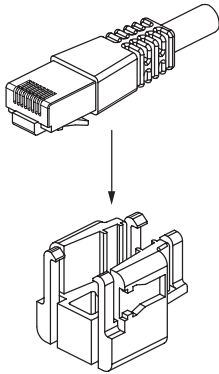


description	part No.	(L) metre
RJ45 male connector with 8 data contacts	CW 1 J2M87	1
	CW 2 J2M87	2
	CW 3 J2M87	3
	CW 5 J2M87	5
	CW 7.5J2M87	7,5
	CW 10 J2M87	10
	CW 15 J2M87	15

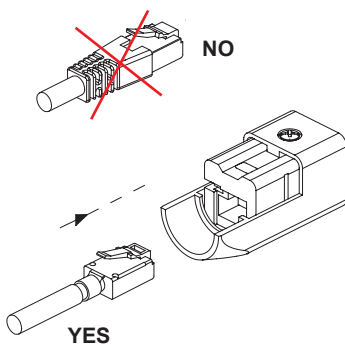
RJ45 patch cord technical data:
 - S/FTP Cat. 7 PUR
 - temperature range: from -40 °C ÷ +75 °C
 - nickel plated brass screening
 - green RAL 6018 colour

Can be used with:
 - MIXO RJ45 **CX 01 J8M** male inserts (see page 302)
 - RJ45 universal patch cord adapter **CJK 8M** (see page 233)
 - **CJK 8MT** adapters

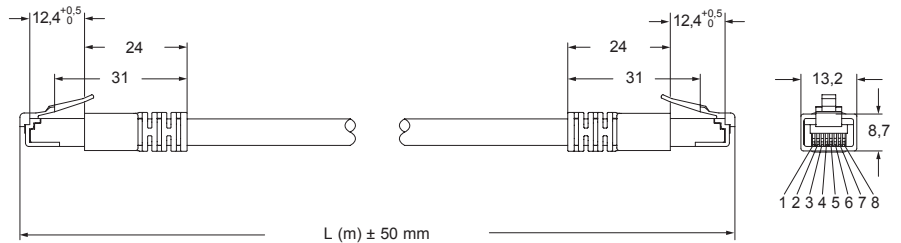
CJK 8MT male assembly



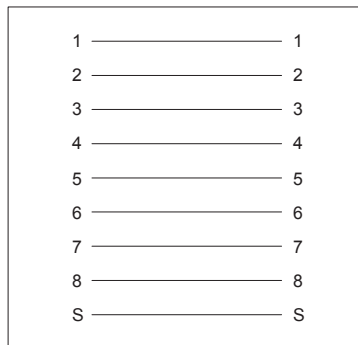
CJK 8FT to be used in VG or IAP enclosures with male crimp version



CW...J2M87



Wiring Diagram

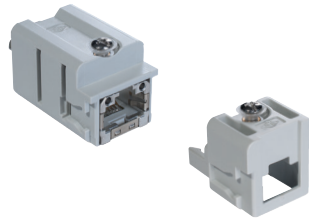


CJK adapters 1 seat for RJ45 IDC connector Cat. 6 Class E_A

enclosures: size "21.21"	page:
insulating type (CK IN, CKG/MKG VN/VAN *)	346 - 348
metallic type (CKAX I, CKAX/MKAX IAP/AP/VG) (CKAG/MKAG V/VA *) (MKAX/MKA/MKAXX IF)	349 and 353 354 - 355 362 - 363
IP68 (CGK I, CGK/MGK IAP, CGK/MGK V)	628 - 631
*) angled enclosures cannot be used with CX 8 J6IM	

- characteristics according to EN 61984:
- 1A 50V 0,8kV 3**
- cULus (UL for USA and Canada) certified
- insulation resistance: ≥ 10 G Ω
- made of self-extinguishing thermoplastic resin UL 94V-0
- mechanical life: ≥ 500 cycles
- temperature range: from -40 °C to +70 °C
- we recommend to fix the cable with cable tie

adapters for RJ45 male connectors,
RJ45 female - cable IDC connectors



RJ45 male connectors,
IDC termination



Watch
our
online
tutorial

description	part No.	part No.
socket insert with 1 RJ45 female-IDC connector contact coding according to T568A	CJK 8IFT	
socket insert with 1 RJ45 female-IDC connector contact coding according to T568B	CJK 8B IFT	
socket insert with 1 RJ45 female-IDC connector contact coding according to PROFINET	CJK 8P IFT	
plug insert for 1 RJ45 male IDC connector, 8 data contacts (without RJ45 connector, to be ordered separately)	CJK 8IMT	
RJ45 male IDC connector, 8 data contacts		CX 8 J6IM

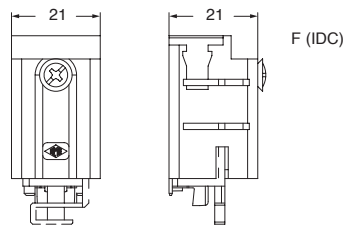
CJK 8IFT, CJK 8B IFT, CJK 8P IFT technical data:

- RJ45 female insert, Cat. 6_A
- Cu-conductor diameter
solid: 0,40 - 0,64 mm (AWG 26/1 - 22/1)
stranded: 0,48 - 0,76 mm (AWG 26/7 - 22/7)
- insulation diameter: 0,85 - 1,6 mm
- shielding housing: zinc diecast
- housing finish: nickel-plated
- current carrying capacity at 50 °C: 1A
- adequate for Power over Ethernet:
PoE according to IEEE 802.3af
- connectors: IEC 60603-7-5
- adequate for 10 Gigabit Ethernet:
10 Gigabit Ethernet acc. to IEEE 802.3an
- custom-designed cabling systems: PROFINET
Installation Guideline
- generic cabling systems:
ANSI/TIA/EIA-568-C.2
ISO/IEC 11801
EN50173-1
ISO/IEC 24702
EN 61918
- class E_A (channel): ISO/IEC 11801, EN 50173-1

CX 8 J6IM technical data:

- RJ45 male IDC connectors Cat. 6 Class E_A
- Cu-conductor diameter
solid: 0,41 - 0,64 mm (AWG 26/1 - 22/1)
stranded: 0,48 - 0,76 mm (AWG 26/7 - 22/7)
- insulation diameter: 0,85 - 1,6 mm
- cable diameter: 5,5 - 8,5 mm
- connectors: IEC 60603-7-5
- category 6_A: ISO/IEC 11801; DIN EN 50173-1
- wrenches pliers for CX 8 J6IM: **CJPW K**
- 10 Gigabit Ethernet acc. to IEEE 802.3an:
adequate for 10 Gigabit Ethernet
- class E_A: ISO/IEC 11801; EN 50173-1
- category 6: ANSI/TIA/EIA-568-C.2
- custom-designed cabling systems:
according to PROFINET Installation Guideline

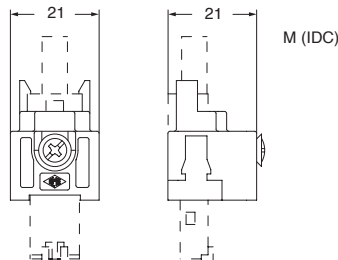
CJK 8IFT



Female-Cable IDC

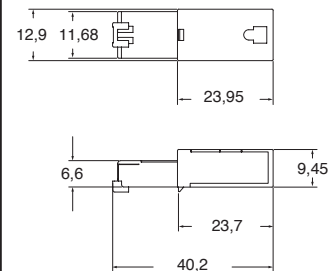


CJK 8IMT ¹⁾

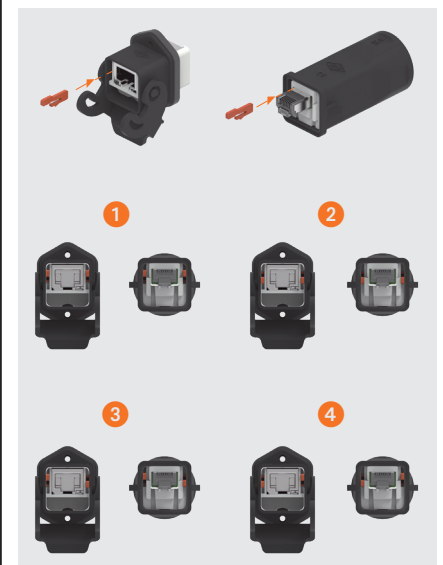


¹⁾ to be used with hoods

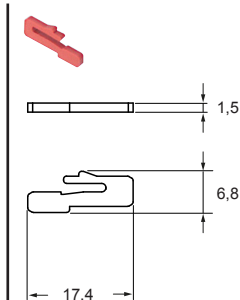
CX 8 J6IM (can be used with CJK 8IMT)



**How to use CR KC coding pins
(cannot be used with IP68 enclosures)**

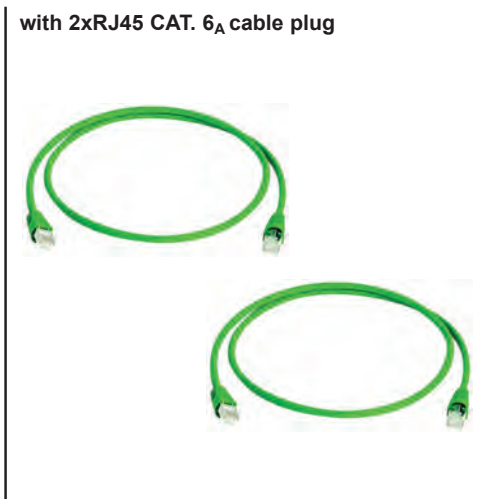


**CR KC
insert coding pin**



DATA CONNECTORS

CW - CWC connecting cables for MIXO RJ45 CAT. 6_A



description	part No.	(L) metre	part No.	(L) metre	part No.	(L) metre
S/FTP CAT. 6A cable 4x2xAWG 27/7 (PUR) * - SHIELEDDED * chemical resistant cable jacket Colour outer jacket green	CW J6 1M	1				
	CW J6 2M	2				
	CW J6 3M	3				
	CW J6 5M	5				
	CW J6 7.5M	7,5				
	CW J6 10M	10				
	CW J6 15M	15				
S/FTP CAT. 6A cable 4x2xAWG 27/7 (PVC) - SHIELEDDED Colour outer jacket green			CWC J6 1M	1		
			CWC J6 2M	2		
			CWC J6 3M	3		
			CWC J6 5M	5		
			CWC J6 7.5M	7,5		
			CWC J6 10M	10		
		CWC J6 15M	15			
Over moulded IP67 to RJ45 plug crimp IP20 S/FTP CAT. 7 cable 4x2xAWG 26/7 (PUR) * * chemical resistant cable jacket Colour outer jacket green					CW XJ0.5M	0,5
					CW XJ1M	1
					CW XJ2M	2
					CW XJ3M	3
					CW XJ5M	5
					CW XJ7.5M	7,5
				CW XJ10M	10	

DATA CONNECTORS

CW - CWC connecting cables for MIXO RJ45 CAT. 5

with 2xRJ45 CAT. 5 cable plug



DATA CONNECTORS

description	part No.	(L) metre	part No.	(L) metre
SF/UTP CAT. 5 4x2xAWG 26/7 (PUR) ¹⁾ - SHIELDED ¹⁾ chemical resistant cable jacket Colour outer jacket green	CW J5 1M	1		
	CW J5 2M	2		
	CW J5 3M	3		
	CW J5 5M	5		
	CW J5 7.5M	7,5		
	CW J5 10M	10		
	CW J5 15M	15		
SF/UTP CAT. 5 4x2xAWG 26/7 (PVC) - SHIELDED Colour outer jacket green			CWC J5 1M	1
			CWC J5 2M	2
			CWC J5 3M	3
			CWC J5 5M	5
			CWC J5 7.5M	7,5
			CWC J5 10M	10
			CWC J5 15M	15

CWH connecting cables for MIXO RJ45 CAT. 6_A - CAT. 5_e

with 2xRJ45 CAT. 6_A cable plug



with 2xRJ45 CAT. 5_e cable plug



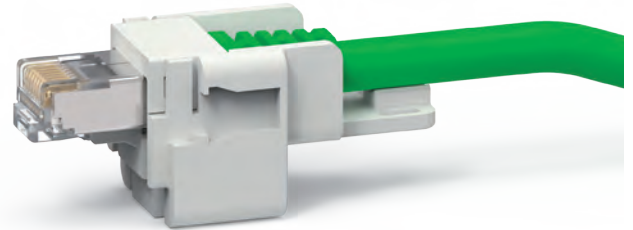
description	part No.	(L) metre	part No.	(L) metre	part No.	(L) metre
CAT. 6_A wiring 1:1 cable S/FTP (LSHZ) - SHIELDED Colour outer jacket green	CWH J6 0.25M	0,25				
	CWH J6 0.5M	0,5				
	CWH J6 1M	1				
	CWH J6 2M	2				
	CWH J6 3M	3				
	CWH J6 5M	5				
	CWH J6 7.5M	7,5				
	CWH J6 10M	10				
	CWH J6 15M	15				
1x90° - 1x180° cable boot CAT. 6_A wiring 1:1 cable S/FTP (LSHZ) - SHIELDED Colour outer jacket green			CWH J6 0,5MA	0,5		
			CWH J6 1MA	1		
			CWH J6 2MA	2		
			CWH J6 3MA	3		
			CWH J6 5MA	5		
			CWH J6 7.5MA	7,5		
			CWH J6 10MA	10		
CAT. 5_e wiring 1:1 cable S/FTP (LSHZ) - SHIELDED Colour outer jacket green			CWH JE 0.5M	0,5		
			CWH JE 1M	1		
			CWH JE 2M	2		
			CWH JE 3M	3		
			CWH JE 5M	5		
			CWH JE 7.5M	7,5		
		CWH JE 10M	10			
		CWH JE 15M	15			

DATA CONNECTORS

CJK 8M

TECHNICAL FEATURES

- **CJK 8M** adapter insert size "21.21" for placing an RJ45 plug (male connector) of a pre-assembled patch cord into a **M25** size "21.21" top cable entry hood, either metal or insulating;
- it allows a **truly "universal"** use thanks to the possibility to install virtually any RJ45 patch cord plugs available on the market (of any Category: Cat. 5, 5e, 6, 6A, 7, or 8) inside the growing range of size "21.21" top entry hoods with glued gasket, **without any disassembly of the patch cord**. A straightforward smart solution, all the more so if compared with more complex and expensive solutions;
- the **proprietary ILME design** of this adapter foresees a **two-part insulating carrier** (the first part acting as **carrier**, the second as **latch**) that can quickly and easily make captive the RJ45 plug (male connector), the assembly is then introduced in the relevant "21.21" M25 top entry hood and fastened to it by the usual screw;
- a **metallic** (nickel plated brass) **or insulating** (light grey or black colour) **M25 cable gland** with suitable internal diameter to let the patch cord RJ45 plug pass-through **is separately available**;
- the **CR CJK G special sealing gasket**, provided with the **CJK 8M** RJ45 universal patch cord adapter, **is longitudinally cut** on its flank and must be applied over the cable to increase its diameter in the portion to introduce in the cable gland sealing, according to instructions;



- suitable for the combination of an RJ45 patch cord with one or both RJ45 plug extremities mounted inside suitable size "21.21" *insulating or metal* M25 top entry hood with glued gasket, with an RJ45 jack counterpart (female connector), e.g. a **CJ KF** adapter combined with the relevant female/female RJ45 connector **CX 8 JF** or **CX 8/2 JF** (4-way version **CX 4 JF** or 4/2-way version **CX 4/2 JF** are available upon request), mounted inside a corresponding counterpart hood or housing with locking lever size "21.21";
- optional four coding positions with **CR KC** insert coding pin (4 pins required for each connector coupling).

CJK 8M

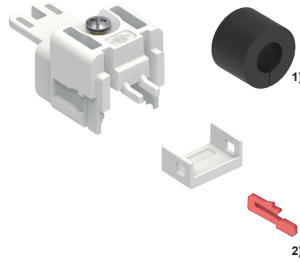
enclosures:
size "21.21"

page:

MKG V25
MKG VN25
MKAG V25

348
348
353

RJ45 universal patch cord adapter



M25 cable gland

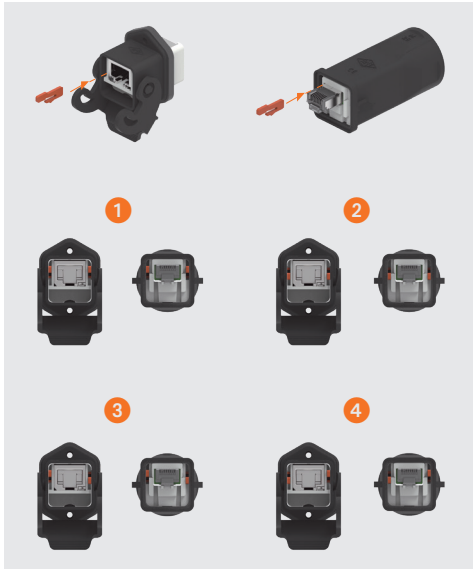


description	part No.	part No.	entry M
universal patch cord adapter	CJK 8M	AW M25IJ	25
insert coding pin for RJ45 adapters (optional) ²⁾	CR KC	AW M25INJ	25
plastic cable gland, light grey (RAL 7035) ³⁾		AW M25PJ	25
plastic cable gland, black (RAL 9005) ³⁾			
nickel plated brass cable gland			

¹⁾ CR CJK G gasket, supplied with CJK 8M universal patch cord adapter, see page 234, note (*****)

²⁾ Optional four coding positions CR KC insert coding pin (4 pins required for each connector coupling)

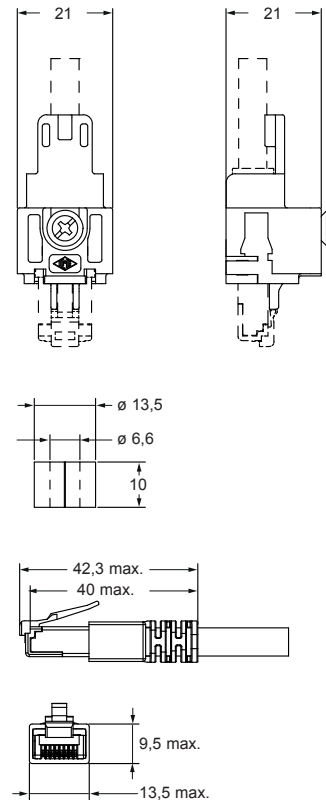
How to use CR KC coding pins (cannot be used with IP68 enclosures)



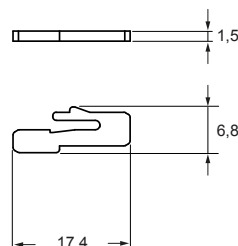
³⁾ IP65 degree of protection; for higher degree we recommend the use of ASR B25 gasket

cURus pending

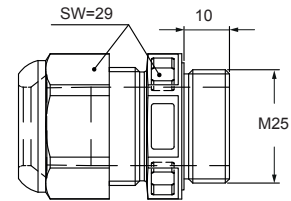
CJK 8M



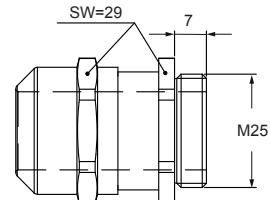
CR KC



AW M25IJ and AW M25INJ



AW M25PJ



Watch our online tutorial

Female inserts

Housings

RJ45 CONNECTOR Cat 6^A

RJ45 female/female coupler
(8 data contacts)



CJK 8FT

RJ45 female/IDC jack
(8 data contacts)



CJK 8IFT
CJK 8B IFT
CJK 8P IFT

RJ45 CONNECTOR Cat 5-5^e

RJ45
female crimp coupler jack
(8 data contacts)



CX 8 JF** + CJ KF

RJ45
female crimp coupler jack
(8 data + 2 power contacts)



CX 8/2 JF** + CJ KF

MK VGN25*****
MK VG25*****

CK 03 IN
CK 03 I

21.21 CK/MK PLASTIC

CKAX 03 I

CKAX 03 ILS

CKAX IAPS*** /APS*** /VGS***
MKAX IAP20*** /AP20*** /VG20***

CKAX 03 IA4*
MKAX AP25 /IAP25*****

MKAX IF MKAX VG25

CKAX 03 CXA
(cover for hoods)

21.21 CKA/MKA METAL

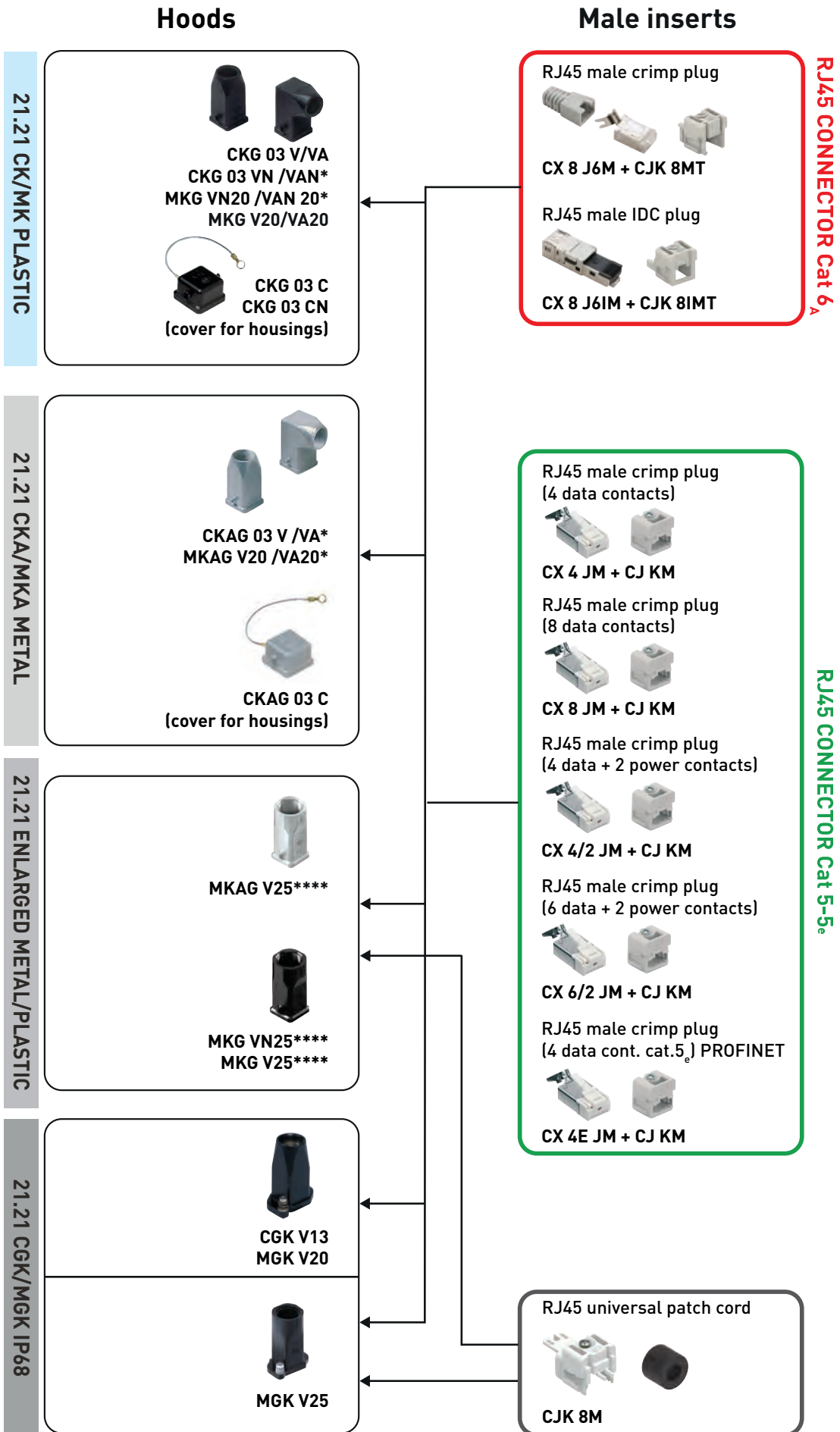
CGK I

CGK IAP13***
MGK IAP20***

21.21 CGK/MGK IP68

Legend

- * angled enclosures cannot be used with CX 8 J6IM, CJK 8FT/IFT, CLK and CJ KF inserts/adapters
- ** version with 4 data crossover wirings on request (CX4 JF, CX4/2 JF)
- *** cannot be used with CJ KF adapter
- **** suitable cable glands AW M25 PJ/IJ/INJ
- ***** suitable cable glands AW M25 PJ/IJ/INJ + CR CJK G gasket (already supplied with the CJK 8M universal patch cord adapter, see page 233, note 1); cannot be used with CJ KF adapter



RJ45 DATA CONNECTORS

RJ45 CONNECTOR Cat 6_A

RJ45 CONNECTOR Cat 5-5_e

CUK adapters with 1 USB connector

enclosures:
size "21.21" page:

insulating type 346 - 348
(CK IN, CKG/MKG VN/VAN *)

metallic type 349 and 353
(CKAX I, CKAX/MKAX IAP/AP/VG) 354 - 355
(CKAG/MKAG V/VA *)

IP68 628 - 631
(CGK I, CGK/MGK IAP, CGK/MGK V)

*) angled enclosures cannot be used with CX 8 J6IM

USB female - female connectors



patch cable USB



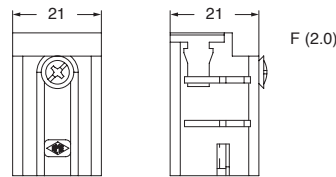
description	part No.	part No.
female insert with USB 2.0 female - female connector	CUK 2FT	CW 2 UAM
female insert with USB 3.0 female - female connector,	CUK 3FT	
patch cable USB-A / USB-A, 2 m ¹⁾		

¹⁾ 5 m on request

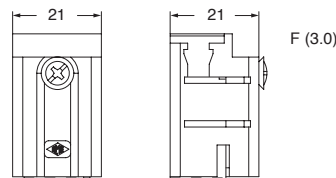
USB connector features:
 - USB-A / USB-A Hi-Speed - 2.0 or 3.0 insert
 - temperature range: from -25 °C to +80 °C

- us (UL for USA and Canada) certified

CUK 2FT

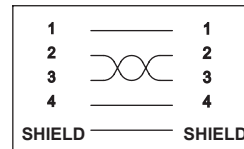
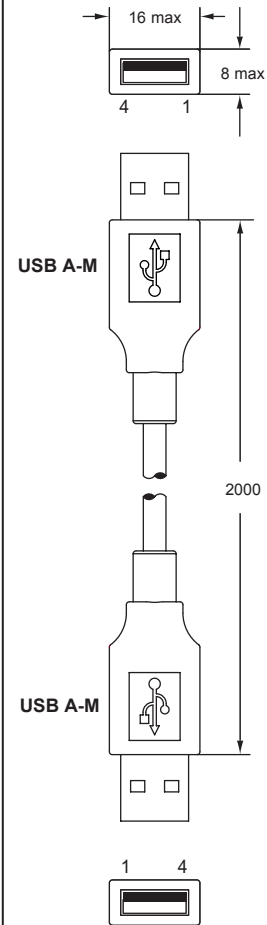


CUK 3FT



inserts already supplied with stainless steel fixing screw with gasket, which ensures IP66/IP67/IP69 degree of protection

CW UAM



ATR cover for boxes for unit Ø 22 mm

cover for RJ45/USB/LC connectors



RJ45/USB/LC connectors for ATR C22



description	part No.	part No.
communication interface bulkhead IP65	ATR C22	
RJ45 jack A Cat.6A ¹⁾		AT 8IFT
RJ45 coupler Cat.6		AT 8FT
USB 2.0 coupler F-F Type A		AT U2F
USB 3.0 coupler F-F Type A		AT U3F
LC-Duplex adapter MM		AT LCMM
LC-Duplex adapter SM		AT LCSM

¹⁾ jack B and jack P on request

Technical Data

Mechanical Characteristics

Materials	
Housing	PA UL94V-0 - black
Nut	PA UL94V-0 - black
Bulkhead protective cap	EPDM
Elastic band / Seal	EPDM
EU Directive 2011/65/EU (RoHS)	RoHS-compliant

Environmental Requirements

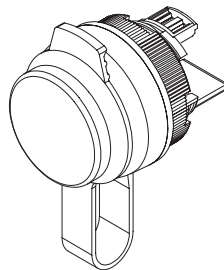
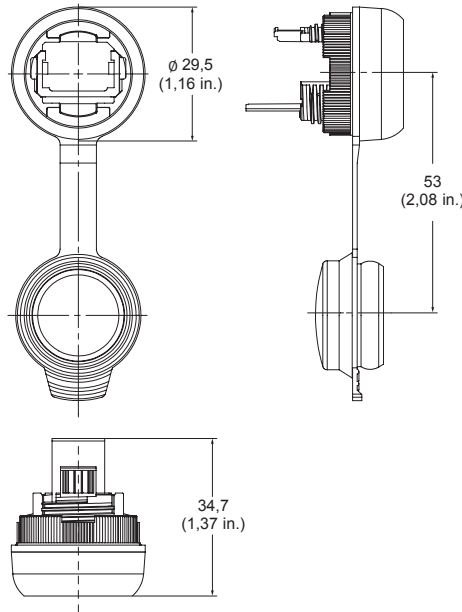
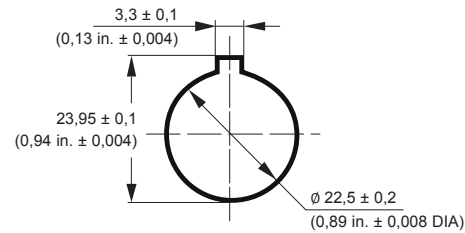
Protection against ingress	
Particulate ingress	IP6X
Water / Immersion	IPX5
Degrees of protection provided by enclosures (IP code)	IEC 60529

Climatical and chemical

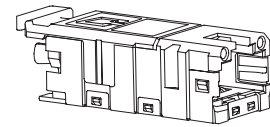
Ambient temperature	-40 °C ... + 70 °C
---------------------	--------------------

Mounting dimensions

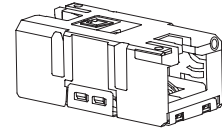
wall thickness 1-5 mm (0,039-0,197 in.)



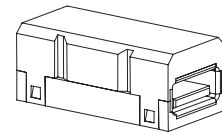
AT 8IFT (RJ45 IDC-FEMALE)



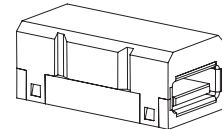
AT 8FT (RJ45 FEMALE-FEMALE)



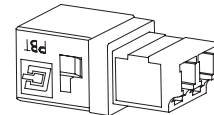
AT U2F (USB 2.0)



AT U3F (USB 3.0)



AT LCMM - AT LCSM (LC DUPLEX)



CLK 04 SC adapters

TECHNICAL FEATURES

The adapter CLK 04 SC enables use of fibre optic SC contacts, up to 4 SC contacts per connector, for indoor or outdoor heavy duty industrial applications, with ILME connector enclosures size "21.21" series CKA (IP66/IP67/IP69, metallic, both C-TYPE, grey-painted, for normal environments, and W-TYPE black-painted, for aggressive environments, only the hood models provided with sealing gasket), series CGK/MGK (IP66/IP68/IP69, metallic, either Pg or metric-threaded cable outlet) and series CK (IP66/IP67/IP69, insulating, only the hood models provided with sealing gasket).

The fibre optic SC contacts (genderless, to be purchased separately) are available both for multi-mode fibres (50/125 μm or 62,5/125 μm) and single-mode fibre (9/125 μm). The fibre optic SC contacts are also available for the hard-clad silica (HCS) or polymer-clad fibre (PCF) 200/230 μm fibre optic cables and for the less demanding, with shorter transmission distance covered, but more cost effective POF \varnothing 1 mm applications, available with crimp technique version (crimping tool required).

NOTE

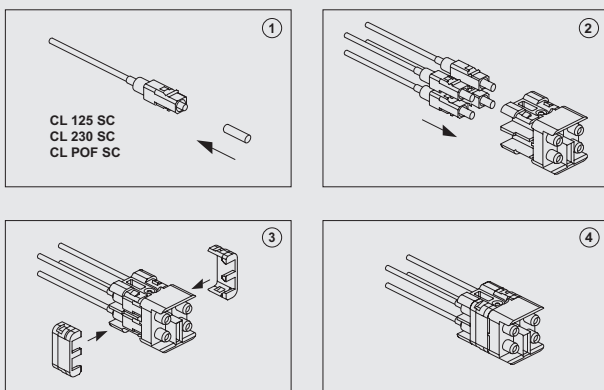
Due to the higher skill and training required to produce an effectively performing fibre optic junction for a single-mode type fibre-optic cable than for a multi-mode one, dedicated contacts for single-mode are available only upon request. Contact our Commercial Department for a quotation. It is more practical in such case to equip the CLK 04 SC adaptor with ready-to-use fibre optic patch cords. Quick assembly technique version (tool-less) for POF \varnothing 1 mm cables are also available only upon request, please send inquiry to our Commercial Department.

The female adapter inserts are provided with 4 ceramic (zirconia) type split alignment sleeves, for minimal insertion loss (e.g. critical network connections) and best suitable for single-mode F/O cable connections. As optional accessory, metallic (phosphor bronze) split alignment sleeves are also available for more durable (less prone to cracking) applications, but less demanding precision alignment, thus most suitable for multi-mode fibre applications.

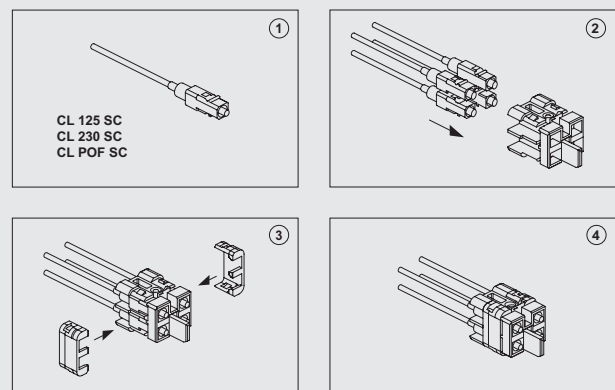
Part No. of adapter	CLK 04 SC
No. of seats/poles for optical contacts	4
Ambient temperature limit (°C)	min -40 / max +70
Degree of protection with enclosures (according to type)	IP66/IP67/IP69, IP66/IP68/IP69
Conductor connections	crimp
Mechanical endurance (rating cycles)	≥ 500
Self-extinguishing capacity UL 94	V0

CLK 04 SC Assembling instructions

FEMALE



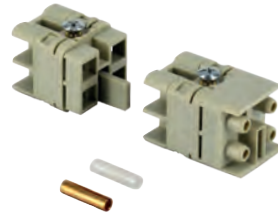
MALE



CLK adapters 4 seats for fibre optic SC contacts

enclosures: size "21.21"	page:
insulating type (CK IN, CKG/MKG VN)	346 - 348
metallic type (CKAX I, CKAX/MKAX IAP/AP/VG)	349 and 353
(CKAG/MKAG V)	354 - 355
(MKAX/MKA/MKAXXIAP/AP25)	358 - 359
(MKAX/MKA/MKAXX VG25)	360 - 361
(MKAX/MKA/MKAXX IF)	362 - 363
IP68 (CGK I, CGK/MGK IAP, CGK/MGK V)	628 - 631

adapter insert for SC connectors



crimp FO contacts

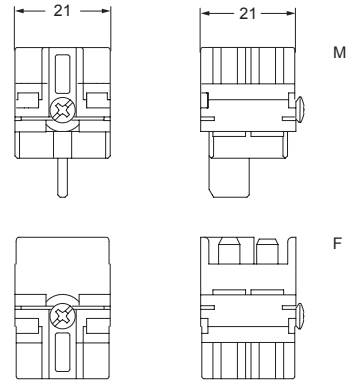


description	part No.	part No.
adapter insert with seats for 4 SC contacts	CLK 04 SCF	CL 125 SC
female insert, with ceramic sleeve	CLK 04 SCF-H	CL POF SC
female insert, with metallic sleeve	CLK 04 SCM	
male insert		
SC contact for GI ¹⁾ FIBRE 50/125 µm or 62.5/125 µm		
SC contact for 1 mm Ø POF		

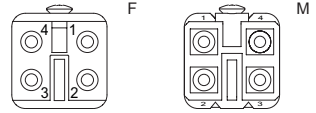
- ¹⁾ GI = Graded Index
- inserts already supplied with stainless steel fixing screw with gasket, which ensures IP66/IP67/IP69 degree of protection
 - adapter insert designed to be used with SC contacts
 - SC contact for SI ²⁾ FIBRE (HCS_®) 200/230 µm: **CL 230 SC** (on request)
 - ²⁾ SI = Step Index
 - base equipment for SC contact GI FIBRE: **CLKZ 125 SC**
If this application is required, please contact ILME S.p.A.
 - supplementary set for POF: **CLKZ POF**
(to be ordered with CLKZ 125 SC)
If this application is required, please contact ILME S.p.A.

- (UL for USA and Canada), certified
 - insulation resistance: ≥ 10 GΩ
 - temperature range: from -40 °C to +70 °C

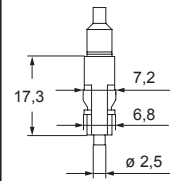
CLK 04 SCF, CLK 04 SCM



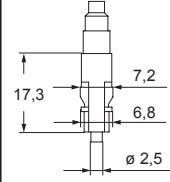
contacts side (front view)



CL 125 SC



CL POF SC



DATA CONNECTORS

CW SC patch cord FO SC duplex patch cords

SC duplex patch cord



SC duplex patch cord



DATA CONNECTORS

description	part No.	(L) metre	part No.	(L) metre
SC duplex patch cord, GL fibre E9/125 (YELLOW)	CW 1 SC9	1		
	CW 2 SC9	2		
	CW 3 SC9	3		
	CW 5 SC9	5		
	CW 10 SC9	10		
SC duplex patch cord, GL fibre G50/125 (ORANGE)	CW 1 SC50	1		
	CW 2 SC50	2		
	CW 3 SC50	3		
	CW 5 SC50	5		
	CW 10 SC50	10		
SC duplex connector, GL fibre G62,5/125 (ORANGE)	CW 1 SC62	1		
	CW 2 SC62	2		
	CW 3 SC62	3		
	CW 5 SC62	5		
	CW 10 SC62	10		

- operating temperature: from -5 °C + +55 °C
- storage temperature: from -30 °C + +70 °C
- installation temperature: from -5 °C + +50 °C
- flame retardancy: IEC 60332-1
- halogen-free acc. to: IEC 60754-2



CX BD adapter insert

TECHNICAL FEATURES

To be able to use circular shielded connectors series **MIXO BUS** (multiaxial, for balanced cables with multiple pairs) or coaxial connectors (for coaxial cables) even in compact enclosures size "21.21" **CK/MK**, **CKA/MKA** or **CGK/MGK**, it is necessary to purchase the adapter insert **CX 1/2 BD**. This insert can be used to assemble MIXO coaxial connectors part No. **CX 01 BM/BF** for coaxial cables with a characteristic impedance of 75 Ω and **CX 01 BCM/BCF** for coaxial cables with a characteristic impedance of 50 Ω, or MIXO BUS **CX 04 BM/BF** multiaxial shielded connectors with 4 poles + shield and **CX 08 BM/BF** shielded connectors with 8 poles + shield, in addition to providing seats for 2 additional optional contacts series CD for the connection of a SELV (safety extra-low voltage) supply line.

The connector portion of this adaptor has rated values compliant with standard EN 61984 and equivalent to 10A 50V 0,8kV 3.

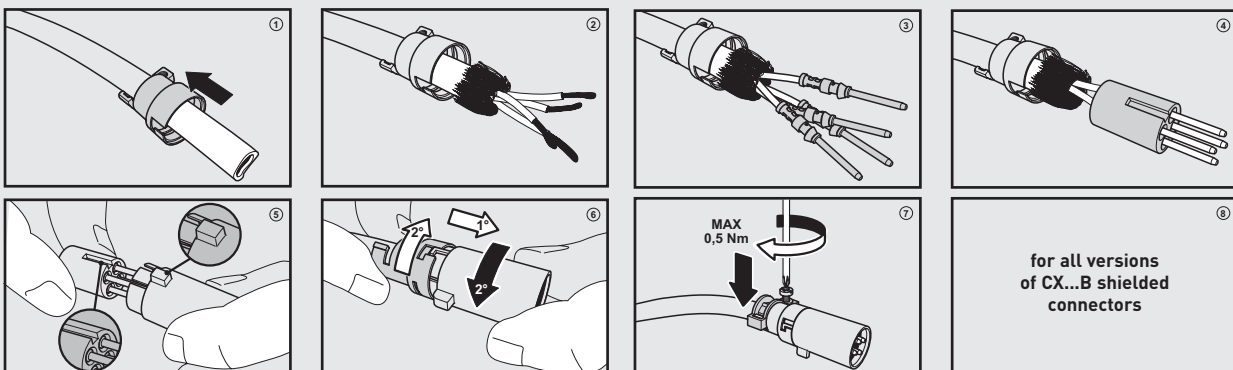
Adaptor insert **CX 1/2 BDM/BDF** is fitted with multiaxial and coaxial MIXO BUS shielded connectors and is designed to be used only with the models specified below of the following enclosures: **CK/MK** or **CKA/MKA** (IP66/IP67/IP69) or **CGK/MGK** (IP66/IP68/IP69) with glued gasket on hoods and covers. The cable shielding is electrically separated from the earthing connection of the metal enclosure. If used with MIXO BUS **CX 04 BM/BF** shielded connectors, the connector is able to support all field bus protocols with 4 conductors.

Part No. of adapter		CX 1/2 BD
No. of seats/poles	seats for shielded connector ¹⁾	1
	seats for auxiliary contacts	2
Rated current ²⁾	shielded connector	depending on type: 5A, 10A, 16A
	auxiliary contacts	10A
EN 61984	rated voltage	50V
	rated impulse withstand voltage	0,8kV
	pollution degree	3
UL 1977 / CSA C22.2 - N°187.3	rated voltage (a.c./d.c.)	50V
Contact resistance	shielded connector	depending on the type of contact used
	auxiliary contacts	≤ 3 mΩ
Insulation resistance		≥ 10 GΩ
Ambient temperature limit (°C)	min	-40
	max	+70
Degree of protection	with enclosures (according to type)	IP66/IP67/IP69, IP66/IP68/IP69
	without enclosures (in mated condition)	IP20 (IPXXB)
Conductor connections		crimp
Conductor section	shielded connector (mm ² /AWG)	depending on the type of contact used
	auxiliary contacts (mm ²)	0,14÷2,5
	auxiliary contacts (AWG)	26÷14
Conductors stripping length		depending on contact
Mechanical endurance (mating cycles)		≥ 500
Self-extinguishing capacity UL 94		V0

¹⁾ Depending on the selected shielded connector, which must be ordered separately, the number of poles + shield could be 1 (coaxial connectors), 4 (4-way multiaxial connector for 2 pairs) or 8 (8-way multiple connector, for example for 4 pairs).

²⁾ It is generally necessary to refer to the loading curves of the inserts to determine the actual operating current limit for a specific ambient temperature. These curves are not required for MIXO BUS / coaxial shielded connectors, because these are signal connectors designed to be used by the transmission protocols to transmit currents in fractions of amperes. The current capacity specified is the maximum current traditionally assigned to contacts, not the one assigned to the shielded connector when in use.

CX 04 BF/BM Assembling instructions



CX BD adapter insert 1 seat for shielded connector + 2 aux contacts 10A - 50V

enclosures: size "21.21"	page:
insulating type (CK IN, CKG/MKG VN)	346 - 348
metallic type (CKAX I, CKAX/MKAX IAP/AP/VG)	349 and 353
(CKAG/MKAG V)	354 - 355
(MKAX/MKA/MKAXXIAP/AP25)	358 - 359
(MKAX/MKA/MKAXX VG25)	360 - 361
(MKAX/MKA/MKAXX IF)	362 - 363
IP68 (CGK I, CGK/MGK IAP, CGK/MGK V)	628 - 631

adapter insert for shielded connectors



10A crimp contacts, silver or gold plated



description	part No.	part No.	part No.
-------------	----------	----------	----------

adapter insert with seats for 1 shielded connector + 2 aux contacts 10A
 female insert, 1 seat for BUS connector and 2 seats for 10A female contacts (CDF)
 male insert, 1 seat for BUS connector and 2 seats for 10A male contacts (CDM)

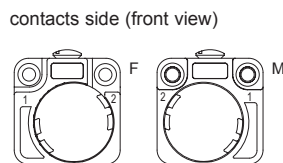
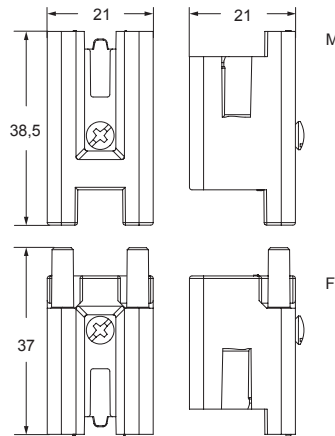
CX 1/2 BDF
CX 1/2 BDM

10A female contacts		
0,14-0,37 mm ²	AWG 26-22	identification No. 1
0,5 mm ²	AWG 20	identification No. 2
0,75 mm ²	AWG 18	identification No. ②
1 mm ²	AWG 18	identification No. 3
1,5 mm ²	AWG 16	identification No. 4
2,5 mm ²	AWG 14	identification No. 5
10A male contacts		
0,14-0,37 mm ²	AWG 26-22	identification No. 1
0,5 mm ²	AWG 20	identification No. 2
0,75 mm ²	AWG 18	identification No. ②
1 mm ²	AWG 18	identification No. 3
1,5 mm ²	AWG 16	identification No. 4
2,5 mm ²	AWG 14	identification No. 5

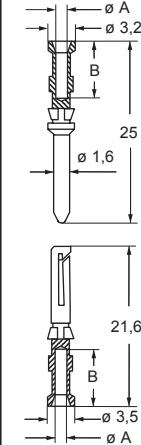
silver plated	CDFA 0.3 CDFA 0.5 CDFA 0.7 CDFA 1.0 CDFA 1.5 CDFA 2.5	gold plated ⁺
	CDMA 0.3 CDMA 0.5 CDMA 0.7 CDMA 1.0 CDMA 1.5 CDMA 2.5	CDFD 0.3 CDFD 0.5 CDFD 0.7 CDFD 1.0 CDFD 1.5 CDFD 2.5
	CDMD 0.3 CDMD 0.5 CDMD 0.7 CDMD 1.0 CDMD 1.5 CDMD 2.5	

- characteristics according to EN 61984: adapter insert CX 1/2 BD (2 aux contacts) **10A 50V 0,8kV 3**
- (UL for USA and Canada), certified
- both the female and the male inserts may accept any of the above shielded connectors of any gender, as far as the correct specular assignment is set on the mating connector
- it is recommended to crimp the contacts with crimping tools homologated by ILME (please see the crimping tool section 10A contacts, CDF and CDM series on pages 708 - 741)
- extraction tool for BUS/coax shielded connectors from adaptor insert CX 1/2 BD part No. CX BES see page 703
- contact resistance adaptor insert, 2 aux contacts: ≤ 3 mΩ
- inserts already supplied with stainless steel fixing screw with gasket, which ensures IP66/IP67/IP69 degree of protections
- adapter insert designed to be used with CX01 BCF/M CX 01 BF/M, CX 04 BF/M and CX 08 BF/M shielded connectors see pages 289, 291, 293

CX 1/2 BDF, CX 1/2 BDM



CDF and CDM



CDF and CDM contacts		
conductor section mm ²	conductor slot ø A (mm)	conductors stripping length B (mm)
0,14-0,37	0,9	8
0,5	1,1	8
0,75	1,3	8
1,0	1,45	8
1,5	1,8	8
2,5	2,2	6

⁺ for basic or high thickness gold plating, please refer to page 674

TECHNICAL FEATURES

DESINA® (which stands for **DE**centralised and **Standardised IN**stallation technology) is an innovative installation concept behind a study headed by the German manufacturers of machine tools association (VDW), with the co-operation of users (including German automotive manufacturers) and component manufacturers, which has led to the introduction of a specification aimed to standardise electrical, hydraulic and pneumatic components and their interconnection on common platform for CNC controlled machine tools and manufacturing lines.

In the last few years, the DESINA® specification has been successfully endorsed by the ISO TC 184/SC 1 "Industrial automation systems and integration / Physical device control" as an ISO standard.

This work has been completed, and the following standards have become available:

ISO 23570-1 Industrial automation systems and integration – Distributed installation in industrial applications:
Part 1 – Sensors and actuators.

ISO 23570-2 Industrial automation systems and integration – Distributed installation in industrial applications:
Part 2 – Hybrid communication bus.

ISO 23570-3 Industrial automation systems and integration – Distributed installation in industrial applications:
Part 3 – Power distribution bus.

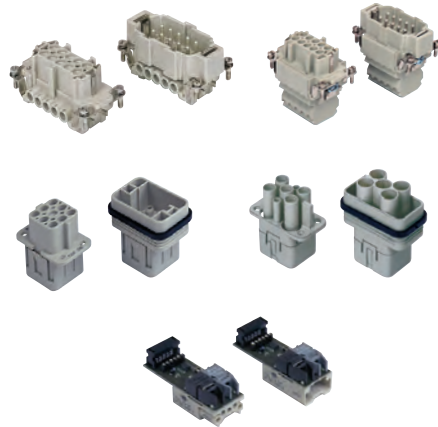
Normally, production systems are controlled by various field buses available on the market such as PROFIBUS, CAN, INTERBUS, etc. DESINA® decentralised approach and interface and connector standardisation, which allows a single distributed control system to be independent from the bus communication protocol selected by the final user, ensure lower installation costs.

The availability of diagnostic capabilities in all the system components ensures a speedier diagnosis in the event of faults and an easier and quicker reset operation, which may be carried out by less specialised staff. DESINA® connection topology requires a **control bus** and a **power bus**.

The hybrid (optical/electrical) control bus provides a serial connection for the devices by using a cable consisting of two fibre optics and four power lines. The devices are fitted with 2 hybrid connectors (and matching flush mounted enclosures) for bus entry and exit.

The hybrid connectors include an interface circuit which turns the TX electrical signal to optical signal with TTL levels and the RX signal from optical to electrical signal with TTL levels.

In other words, **the interface is independent from the selected field bus protocol**, and simply converts the electrical signals into optical signals and vice versa; by doing so, the physical connection between the devices can be used for different bus protocols and can reach a 50 m range by using POF plastic fibres or 300 m by using HCS® fibreglass (Hard Clad Silica – Spectran Corporation registered trademark). The highest baud rate is 12 Mbit/s, compatible with the most advanced field buses.



**ISO 23570-3 standard and
DESINA® specification compliant**

Another variant is also available, which is based on transmitting data on a pair of screened copper cables (instead of fibre optics); in this case, however, the system can only be used for PROFIBUS or CAN buses with RS 485 TX signals.

In both cases, the connector is fitted with housings for 5, 10A auxiliary contacts (**CD** series crimp contacts), which allow all connected devices to receive a permanent direct voltage of 24V (to supply circuits) and a 24V non permanent power supply (only used to open the contactors after operating an emergency switch or a safety switch), as well as a contact available for an optional earth.

The power bus provides a serial connection for drives, controls and power supplies and, more specifically, is suitable to supply power to motors and to their control units.

The standard connector to control motors is the **CQM/F 08** which, with 8 poles + ⊕ 16A 500V, and **CC** series crimp contacts, not only provides a power connection, but also connects the motor brake and safety thermistor.

Another variant is available in the same sizes as the enclosure: **CQM/F 04/2** featuring 4 poles + ⊕ 40A 400/690V and 2, 10A 250V auxiliaries.

For the motor side connection, the connector **CNEM/F 10** (10P + ⊕ 16A 500V 6kV 3, with screw terminals) should be used; with the option to make a star or a delta connection on the connector, the **CSSM/F 10** connector (10P + ⊕ 16A 500V 6kV 3, with spring terminals, two per pole) should be used.

ILME connectors are manufactured to DESINA® specifications and in compliance with ISO 23570-2 and 23570-3 standards.

Hybrid socket and plug connectors for field buses compliant with DESINA® specifications and with ISO 23570-2 standard

The hybrid connectors for field buses are listed below:

- optical field bus **plug**

- optical field bus **socket**

electrical auxiliary female contacts

CXL 2/4 PF (for plastic fibre optics POF)

CXL 2/4 PFH (for glass fibre optics HCS®)

CXL 2/4 SF

electrical auxiliary male contacts

CXL 2/4 PM (for plastic fibre optics POF)

CXL 2/4 PMH (for glass fibre optics HCS®)

CXL 2/4 SM

The hybrid inserts for **socket** type optical field buses can only be fitted inside **fixed enclosures**.

The **plug** types, on the other hand, can only be fitted inside **free enclosures (hoods)**.

The enclosures and matching accessories available are listed below:

Construction details

- fixed, flush mounted enclosure:

- free enclosures (hoods), top entry:

- free enclosures (hoods), side entry:

- cover:

Material: **PLASTIC**

CK 03 IN

CKG 03 VN (Pg 11)

MKG VN20 (M 20)

CKG 03 VAN (Pg 11)

MKG VAN20 (M 20)

CKG 03 CN

Material: **METAL**

CKAX 03 I

CKAG 03 V (Pg 11)

MKAG V20 (M 20)

CKAG 03 VA (Pg 11)

MKAG VA20 (M 20)

CKAG 03 C

The portable enclosures and the covers are fitted with an additional seal in order to achieve the versatile **IP65/IP67** degree of protection according to IEC/EN 60529. With these accessories the enclosures also achieve the **IP69** degree of protection (tightness to high pressure and temperature water jets) according to the same standard. The full versatile degree of protection becomes therefore **IP65/IP67/IP69**. The **IPX9** test is identical with that of former German standard DIN 40050-9 (IP69K) currently specified by **ISO 20653** for use on board road vehicles.

Specifications

Interface

Hybrid electrical-optical connector insert consisting of 2 connectors for fibre optics and 4 contacts for electrical wires; an interface circuit built into the optical socket converts the electrical signals into optical signals and vice versa.

Optical parts

transmitter (T): Agilent (HP) Versatile Link HFBR-1525, or equivalent

receiver (R): Agilent (HP) Versatile Link HFBR-2525, or equivalent

male optical contact: Agilent (HP) Versatile Link

HFBR-4531, or equivalent, Simplex snap-in type (without crimping) for POF plastic fibre optics;

HFBR-4521, or equivalent, crimp contact, for HCS® glass fibre optics

note: POF is a plastic fibre optic with a 1000 µm diameter for red light and wavelength = 660 nm.

HCS® is a Hard Clad Silica glass fibre optic with a 200 µm diameter for red light with wavelength = 660 nm.

Optical parts:

laser class I

Electrical contacts

4 maximum current 10A, gold or silver plated brass crimp contacts, cable section 0,14...2,5 mm² (CD series); live wire end female. Nominal voltage 24V.

Electrical data in compliance with EN 61984: **10A 25V 0,8kV 3**

Degrees of protection: IP65/IP67/IP69 according to EN 60529 (if a cable clamp with IP67/IP69 rating is used).

Temperature range: -40 °C / +70 °C

Data transmission/reception rate (Data rate): up to 12 Mbit/s

Designation of auxiliary electrical contacts

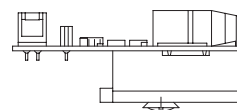
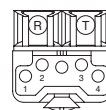
Designation of auxiliary electrical contacts (male and female) in the hybrid socket connector with optical TX system:

Socket connector with male auxiliary electrical contacts CXL 2/4 SM

Pos.	Function
1:	+ 24V not switched
2:	0V (reference for contact 1)
3:	0V (reference for contact 4)
4:	+ 24V switched

optical →

electrical →

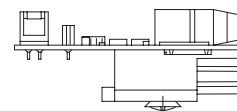
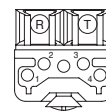


Socket connector with female auxiliary electrical contacts CXL 2/4 SF

Pos.	Function
1:	+ 24V not switched
2:	0V (reference for contact 1)
3:	0V (reference for contact 4)
4:	+ 24V switched

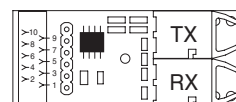
optical →

electrical →



Insulation displacement connector (IDC) for ribbon flat cable on printed circuit

Pos.	Function	Pos.	Function
1:	earth	6:	TXD
2:	RXD	7:	earth
3:	RXD	8:	+5V DC
4:	earth	9:	+5V DC
5:	TXD	10:	earth



The contacts in the hybrid socket connector are numbered in a clockwise direction.

With reference to this, the contacts in the field bus hybrid plug connector are numbered anticlockwise.

"R" Data reception (beam exit) - "T" Data transmission (beam entry).

Socket and plug connectors for power buses compliant with DESINA® specifications and with ISO 23570-3 standard

The connector inserts on the power bus for a motor controller are as follows:

- **CQM 08** plug
- **CQF 08** socket

The connector inserts for the motor controller may be fitted inside the following enclosures:

Construction details
Material: **PLASTIC**

- bulkhead mounting, straight, fixed enclosure: **CQ 08 I**
- bulkhead mounting, angled, fixed enclosure: **CQ 08 IA**
- bulkhead mounting, angled, fixed enclosure, rear entry: **CQ 08 IAP**
- free enclosure (hood), top entry: **CQ 08 V**
- free enclosure (hood), side entry: **CQ 08 VA**
- free enclosure (hood), top entry and lever: **CQ 08 VG**
- free enclosure (hood), side and top entry: **MQ 08 VO225**
- socket cover: **CQ 08 C**
- plug cover: **CQ 08 CA**

The **CQ/MQ 08** enclosures and covers once complete and fitted with suitably rated cable gland or conduit fitting ensure the versatile **IP65/IP67** degree of protection according to IEC/EN 60529. With these accessories the enclosures also achieve the **IP69** degree of protection (tightness to high pressure and temperature water jets) according to the same standard. The full versatile degree of protection becomes therefore **IP65/IP67/IP69**. The **IPX9** test is identical with that of former German standard DIN 40050-9 currently specified by **ISO 20653** for use on board road vehicles.

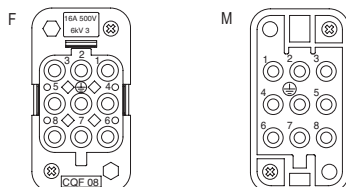
Specifications

- Connection:** **9 contacts (8 + ⊕)**
The male connectors (plugs) are used for termination of connecting cables; the female connectors (sockets) are fitted on the motor controller
- Electrical contacts:** 9 maximum current 10A, gold or silver plated crimp contacts, cable section 0,5...2,5 mm² (20 AWG -14 AWG) CC series
- Degrees of protection:** IP65/IP67/IP69 according to EN 60529 (if a cable clamp with IP67/IP69 rating is used)
- Temperature range:** -40 °C / +125 °C
- Electrical data:** compliant with EN 61984: **16A 500V 6kV 3**
- Self extinguishing properties:** 94V-0 compliant with UL 94 standard; glow-wire 960 °C compliant with IEC/EN 60695-2-11 standard

Designation of contacts

The designation of contacts for motor controller outlet is as follows:

contact	designation
1	line L1
2	
3	line L3
4	brake (0 V)
5	temperature sensor
6	brake (+24V c.c.)
7	line L2
8	temperature sensor
PE	protective earth



The connector inserts on the power bus for a motor controller are as follows:

- **CQM 04/2** plug
- **CQF 04/2** socket

These connector inserts can be fitted inside the following enclosures:

Construction details
Material: **PLASTIC**

- bulkhead mounting, straight, fixed enclosure: **CQ 08 I**
- bulkhead mounting, angled, fixed enclosure: **CQ 08 IA**
- bulkhead mounting, angled, fixed enclosure, rear entry: **CQ 08 IAP**
- free enclosure (hood), top entry: **CQ 08 V**
- free enclosure (hood), side entry: **CQ 08 VA**
- free enclosure (hood), top entry and lever: **CQ 08 VG**
- free enclosure (hood), side and top entry: **MQ 08 VO225**
- socket cover: **CQ 08 C**
- plug cover: **CQ 08 CA**

The **CQ/MQ 08** enclosures and covers once complete and fitted with suitably rated cable gland or conduit fitting ensure the versatile **IP65/IP67** degree of protection according to IEC/EN 60529. With these accessories the enclosures also achieve the **IP69** degree of protection (tightness to high pressure and temperature water jets) according to the same standard. The full versatile degree of protection becomes therefore **IP65/IP67/IP69**. The **IPX9** test is identical with that of former German standard DIN 40050-9 (IP69K) currently specified by **ISO 20653** for use on board road vehicles.

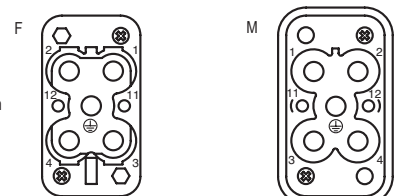
Specifications

- Connection:** **5 (4 + ⊕) power contacts + 2 auxiliary contacts**
The male connectors (plugs) are used for termination of connecting cables; the female connectors (sockets) are fitted on the motor controller
- Electrical contacts:** 5 maximum current 40A (3P+N+⊕) gold or silver plated crimp contacts, cable section 1,5...6 mm² (16 AWG -10 AWG) CX series; 2 maximum current 10A, gold or silver plated crimp contacts, cable section 0,14...2,5 mm² (26 AWG -14 AWG) CD series
- Degrees of protection:** IP65/IP67/IP69 according to EN 60529 (if a cable clamp with IP67/IP69 rating is used)
- Temperature range:** -40 °C / +125 °C
- Electrical data:** compliant with EN 61984: **40A 400/690V 6kV 3**
- Self extinguishing properties:** 94V-0 compliant with UL 94 standard glow-wire 960 °C compliant with IEC/EN 60695-2-11 standard

Designation of contacts

The designation of contacts for motor controller outlet is as follows:

contact	designation
1	line L1
2	line L2
3	line L3
4	neutral
PE	protective earth
11	aux
12	aux



The connector inserts on the power bus for a motor controller are as follows:

	screw type	spring type
	with cover	dual terminal for pole
- plug	CNEM 10 T	CSSM 10
- socket	CNEF 10 T	CSSF 10

To be installed in the enclosures illustrated in this catalogue or equivalent, with single lever (directed towards the motor).

The enclosures once complete and fitted with suitably rated cable gland or conduit fitting ensure the versatile **IP65/IP67** degree of protection according to IEC/EN 60529. With these accessories the enclosures also achieve the **IP69** degree of protection (tightness to high pressure and temperature water jets) according to the same standard. The full versatile degree of protection becomes therefore **IP65/IP67/IP69**. The **IPX9** test is identical with that of former German standard DIN 40050-9 (IP69K) currently specified by **ISO 20653** for use on board road vehicles.

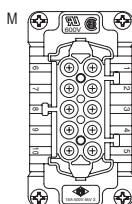
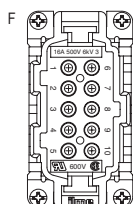
Specifications

Connection:	10 contacts + ⊕
Electrical contacts:	10 screw type contacts (CNE series) or spring type (CSS series), maximum current 16A, silver plated, wire section 0,5...2,5 mm ² (20 AWG -14 AWG)
Degrees of protection:	IP65/IP67/IP69 according to EN 60529 (if a cable clamp with IP67/IP69 rating is used).
Temperature range:	-40 °C / +125 °C
Electrical data	compliant with EN 61984: 16A 500V 6kV 3
Self extinguishing properties	94V-0 compliant with UL 94 standard glow-wire 960 °C compliant with IEC/EN 60695-2-11 standard

Designation of contacts

The designation of contacts for motor connector is as follows:

contact	designation
1	winding U1 - L1
2	winding V1 - L2
3	winding W1 - L3
4	brake (0 V)
5	brake (+24V cc)
6	winding W2
7	winding U2
8	winding V2
9	temperature sensor
10	temperature sensor
PE	protective earth

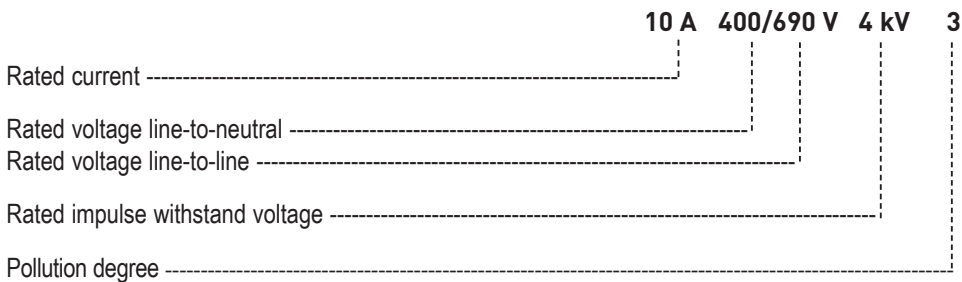


Inserts series	No. of poles		EN 61984 (2001-11) pollution degree 3			EN 61984 (2001-11) pollution degree 2			Certification UL/CSA
	main contacts	aux. contacts	rated voltage	rated impulse withstand voltage	pollution degree	rated voltage	rated impulse withstand voltage	pollution degree	
Code									rated voltage AC or DC
CXL 2/4	2	—	contacts for plastic fibre optics (POF) Ø 1mm						—
		4 (+⊕)	25V	0,8kV	3	—	—	—	50V
CXL 2/4...H	2	—	contacts for HCS® fibre optics Ø 200 µm						—
		4 (+⊕)	25V	0,8kV	3	—	—	—	50V
CQ 08	8 (+⊕)	—	500V	6kV	3	400/690V	6kV	2	600V
CQ 04/2	4 (+⊕)	—	400/690V	6kV	3	—	—	—	600V
		2	250V	4kV	3	—	—	—	600V
CQ 12	10 (+⊕)	—	500V	6kV	3	400/690V	6kV	2	600V
CNE	12 (+⊕)	—	400V	6kV	3	400/690V	6kV	2	600V

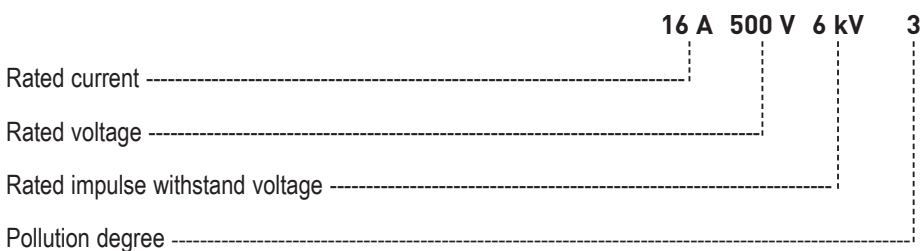
Nominal Data

Nominal data complies with requirements of EN 61984 standard.

Marking example to be applied only in a mains power supply with insulated neutral or with neutral to earth in a corner (see Table 5, EN 61984):



Marking example to be applied in any mains power supplies, including those with insulated neutral and the delta power supplies with earth in a corner (see Table 5, EN 61984):



Insert series	max. rated current ¹⁾	contact resistance ≤	insulation resistance ≥	Ambient temperature limit (° C)		Protection rating		Wire connection ²⁾					Certifications
				min	max	with enclosures	without enclosures (in mated condition)	screw	spring	connection block at 45°	crimp	snap-in	
Code													
CXL 2/4	—	—	—	-40	+70	IP65/IP67	IP20 ³⁾	—					—
	10A	3 mΩ	10 GΩ	-40	+70	IP65/IP67	IP20 ³⁾	—	—	•	—	—	UL, CSA, DNV-GL, BV, EAC
CXL 2/4...H	—	—	—	-40	+70	IP65/IP67	IP20 ³⁾	—	—	•	—	—	—
	10A	3 mΩ	10 GΩ	-40	+70	IP65/IP67	IP20 ³⁾	—	—	•	—	—	UL, CSA, DNV-GL, BV, EAC
CQ 08	16A	1 mΩ	10 GΩ	-40	+125	IP65/IP67	IP20 ³⁾	—	—	•	—	—	cUL _A), CSA, CQC, DNV-GL, BV, EAC
CQ 04/2	40A	0,3 mΩ	10 GΩ	-40	+125	IP65/IP67	IP20 ³⁾	—	—	•	—	—	cUL _A), CSA, CQC, DNV-GL, BV, EAC
	10A	3 mΩ	10 GΩ										
CQ 12	10A	3 mΩ	10 GΩ	-40	+125	IP66/IP67	IP20 ³⁾	—	—	•	—	—	cUL _A), CSA, CQC, DNV-GL, BV, EAC
CNE	16A	1 mΩ	10 GΩ	-40	+125	IP65	IP20 ³⁾	•	—	—	—	—	cUL _A), CSA, CQC, DNV-GL, BV, EAC

¹⁾ See the insert load curves to establish the actual maximum operating current according to the ambient temperature







²⁾ For the wire electrical connection data, see from page 22

³⁾ IPXXB.

^{A)} UL for USA and Canada









Contacts series

10A max contacts - CD series

Conductor section		Number Identification
(mm ²)	AWG	
0,14 - 0,37	26 - 22	
0,5	20	
0,75	18	
1	18	
1,5	16	
2,5	14	

Contacts supplied in both silver/gold plated versions

16A max contacts - CC series

Conductor section		Throat Identification
(mm ²)	AWG	
0,14 - 0,37	26 - 22	
0,5	20	
0,75	18	
1	18	
1,5	16	
2,5	14	
3,0	12	
4	12	

Contacts supplied in both silver/gold plated versions; male contacts can also be supplied in the "advanced" version and iron/constantan contacts for thermocouples J type.

40A max contacts - CX series

Conductor section		Number hole
(mm ²)	AWG	
1,5	16	Ø 1,75 mm
2,5	14	Ø 2,25 mm
4	12	Ø 2,85 mm
6	10	Ø 3,5 mm

Contacts supplied in both silver/gold plated versions

CXL 2 p fibre optics + 4 p 10A max - 25V/0,8kV/3 + ⊕ opt. DESINA®

enclosures: size "21.21"	page:
insulating type	346
metallic type	353
	362 - 363
W-TYPE for aggressive environments (MKAXW IF, MKAXXW IF)	516 - 517
(MKAXW VG25, MKAXXW VG25)	518
EMC (MKAXS IF, MKAS/MKAXXS IF)	568 - 569
(MKAXS IVG20, MKAS/MKAXXS IVG20)	570 - 571

inserts, crimp connections



10A crimp contacts
silver and gold plated



description	part No.	part No.	part No.
-------------	----------	----------	----------

inserts for fixed enclosures, complete with electro-optical interface ¹⁾
without contacts (to be ordered separately)
socket inserts for female contacts
plug inserts for male contacts

CXL 2/4 SF
CXL 2/4 SM

without electro-optical interface for housings
without contacts (to be ordered separately)
socket inserts for female contacts
plug inserts for male contacts

CXL SF
CXL SM

10A female contacts

0,14-0,37 mm ²	AWG 26-22	identification No. 1
0,5 mm ²	AWG 20	identification No. 2
0,75 mm ²	AWG 18	identification No. ②
1 mm ²	AWG 18	identification No. 3
1,5 mm ²	AWG 16	identification No. 4
2,5 mm ²	AWG 14	identification No. 5

silver plated	CDFA 0.3	CDFD 0.3
	CDFA 0.5	CDFD 0.5
	CDFA 0.7	CDFD 0.7
	CDFA 1.0	CDFD 1.0
	CDFA 1.5	CDFD 1.5
	CDFA 2.5	CDFD 2.5

10A male contacts

0,14-0,37 mm ²	AWG 26-22	identification No. 1
0,5 mm ²	AWG 20	identification No. 2
0,75 mm ²	AWG 18	identification No. ②
1 mm ²	AWG 18	identification No. 3
1,5 mm ²	AWG 16	identification No. 4
2,5 mm ²	AWG 14	identification No. 5

gold plated⁺	CDMA 0.3	CDMD 0.3
	CDMA 0.5	CDMD 0.5
	CDMA 0.7	CDMD 0.7
	CDMA 1.0	CDMD 1.0
	CDMA 1.5	CDMD 1.5
	CDMA 2.5	CDMD 2.5

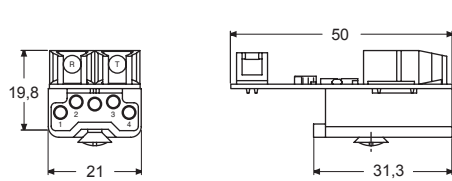
¹⁾ fitted with IDC connector for TTL to bus connection ribbon cable

- characteristics according to EN 61984:

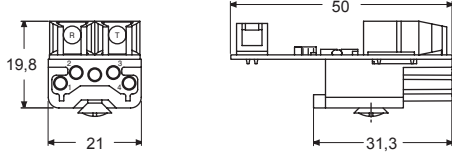
10A 25V 0,8kV 3

- certified
- rated voltage according to UL/CSA: 600V
- insulation resistance: ≥ 10 GΩ
- data baud rate: up to 12 MBit/s
- temperature range: from -40 °C to +70 °C
- contact resistance: ≤ 3 mΩ
- inserts already supplied with stainless steel fixing screw with gasket, which ensures IP66/IP67/IP69 degree of protection
- **it is recommended to crimp the contacts with crimping tools homologated by ILME** (please see the crimping tool section 10A contacts, CDF and CDM series on pages 708 - 741)

CXL 2/4 SM



CXL 2/4 SF



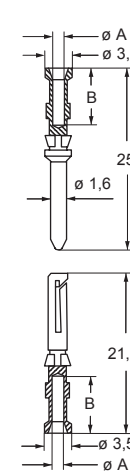
CXL SM



CXL SF



CDF and CDM



CDF and CDM contacts

conductor section mm ²	conductor slot ø A (mm)	conductors stripping length B (mm)
0,14-0,37	0,9	8
0,5	1,1	8
0,75	1,3	8
1,0	1,45	8
1,5	1,8	8
2,5	2,2	6

⁺ for basic or high thickness gold plating, please refer to page 674

CXL 2 p fibre optics + 4 p 10A max - 25V/0,8kV/3 + ⊕ opt. DESINA®

enclosures: size "21.21"	page:
insulating type	346 - 348
metallic type	353 - 355 358 - 363
W-TYPE for aggressive environments	
(MKAXW IAP25/AP25)	514
(MKAXXW IAP25/AP25)	515
(MKAXW IF, MKAXXW IF)	516 - 517
(MKAXW VG25, MKAXXW VG25)	518
EMC	
(MKAXS IAP25/AP25)	566
(MKAS/MKAXXS IAP25/AP25)	567
(MKAXS IF, MKAS/MKAXXS IF)	568 - 569
(MKAXS IVG20, MKAS/MKAXXS IVG20)	570 - 571
(MKAXS/MKAS/MKAXXS VG25)	572

inserts, snap-in (POF)
or crimp (HCS®) optical connection
electrical crimp connection



10A crimp contacts
silver and gold plated



description	part No.	part No.	part No.
inserts for portable enclosures with: 4 + 1 crimp 1,5 mm ² contacts (included) + 2 snap on contacts for 1 mm ¹⁾ plastic (POF) fibre optics socket inserts with CDFA 1.5 female contacts plug inserts with CDMA 1.5 male contacts	CXL 2/4 PF CXL 2/4 PM		
inserts for hoods with: 4 + 1 crimp 1,5 mm ² contacts (included) + 2 crimp contacts for 0,2 mm ²⁾ HCS® fibre optics socket inserts with CDFA 1.5 female contacts plug inserts with CDMA 1.5 male contacts	CXL 2/4 PFH CXL 2/4 PMH		
inserts for hoods with: 4 + 1 crimp contacts (not included – CDF and CDM series) + 2 snap on POF fibre optic contacts (not included) ³⁾ socket inserts with female contacts plug inserts with male contacts	CXL PF CXL PM		
10A female contacts			
0,14-0,37 mm ² AWG 26-22 identification No. 1		CDFA 0.3	CDFD 0.3
0,5 mm ² AWG 20 identification No. 2		CDFA 0.5	CDFD 0.5
0,75 mm ² AWG 18 identification No. ②		CDFA 0.7	CDFD 0.7
1 mm ² AWG 18 identification No. 3		CDFA 1.0	CDFD 1.0
1,5 mm ² AWG 16 identification No. 4		CDFA 1.5	CDFD 1.5
2,5 mm ² AWG 14 identification No. 5		CDFA 2.5	CDFD 2.5
10A male contacts			
0,14-0,37 mm ² AWG 26-22 identification No. 1		CDMA 0.3	CDMD 0.3
0,5 mm ² AWG 20 identification No. 2		CDMA 0.5	CDMD 0.5
0,75 mm ² AWG 18 identification No. ②		CDMA 0.7	CDMD 0.7
1 mm ² AWG 18 identification No. 3		CDMA 1.0	CDMD 1.0
1,5 mm ² AWG 16 identification No. 4		CDMA 1.5	CDMD 1.5
2,5 mm ² AWG 14 identification No. 5		CDMA 2.5	CDMD 2.5

silver plated

gold plated⁺

¹⁾ for POF fibre preparation, the polishing kit Agilent HFBR-4593 (CXL POL) is available on request

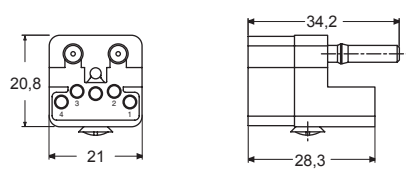
²⁾ for HCS® (Hard Clad Silica - SpecTran Corporation registered™) connection preparation, the Crimp & Clear cabling kit (without glue or polishing kit) for simplex connectors for 200/300 µm HCS® fibre optics is available on request.
The (CXL KCC) kit consists of:
- No. 1 scissors for kevlar cutting
- No. 1 cable stripper
- No. 1 fibre stripper
- No. 1 calibrated pliers
- No. 1 precision fibre optics cutter with diamond blade.
- All accessories are stored in a hard carrying case

³⁾ see data on page 245

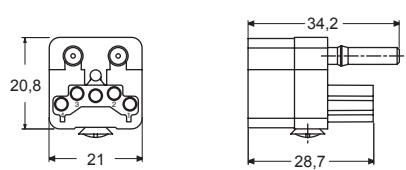
- characteristics according to EN 61984:
10A 25V 0,8kV 3

- certified
- rated voltage according to UL/CSA: 600V
- insulation resistance: ≥ 10 GΩ
- temperature range: from -40 °C to +70 °C
- contact resistance: ≤ 3 mΩ
- inserts already supplied with stainless steel fixing screw with gasket, which ensures IP66/IP67/IP69 degree of protection
- **it is recommended to crimp the contacts with crimping tools homologated by ILME** (please see the crimping tool section 10A contacts, CDF and CDM series on pages 708 - 741)

CXL 2/4 PM and PMH

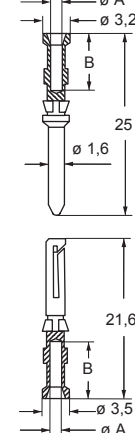


CXL 2/4 PF and PFH



- 8 mm wire stripping
- POF 7 mm fibre stripping

CDF and CDM



⁺ for basic or high thickness gold plating, please refer to page 674

CDF and CDM contacts

conductor section mm ²	conductor slot ø A (mm)	conductors stripping length B (mm)
0,14-0,37	0,9	8
0,5	1,1	8
0,75	1,3	8
1,0	1,45	8
1,5	1,8	8
2,5	2,2	6

MIXO INSERTS

MIXO



- Crimp
4A/5A/10A/16A/40A/70A/100A/200A

From page..... 262



- Screw terminal
40A

From page..... 268



- Spring
16A

From page..... 273



- Dummy module - Pneumatic contacts

From page..... 309



- Frames

From page..... 316



- PE terminal adapters for MIXO frames

From page..... 319

MIXO DATA



- Gigabit - BUS - USB - D-SUB

- POF/MOST® - Coaxial - Optic - RJ45

From page..... 286

MIXO HNM



- Crimp
10A/16A/40A

From page..... 321

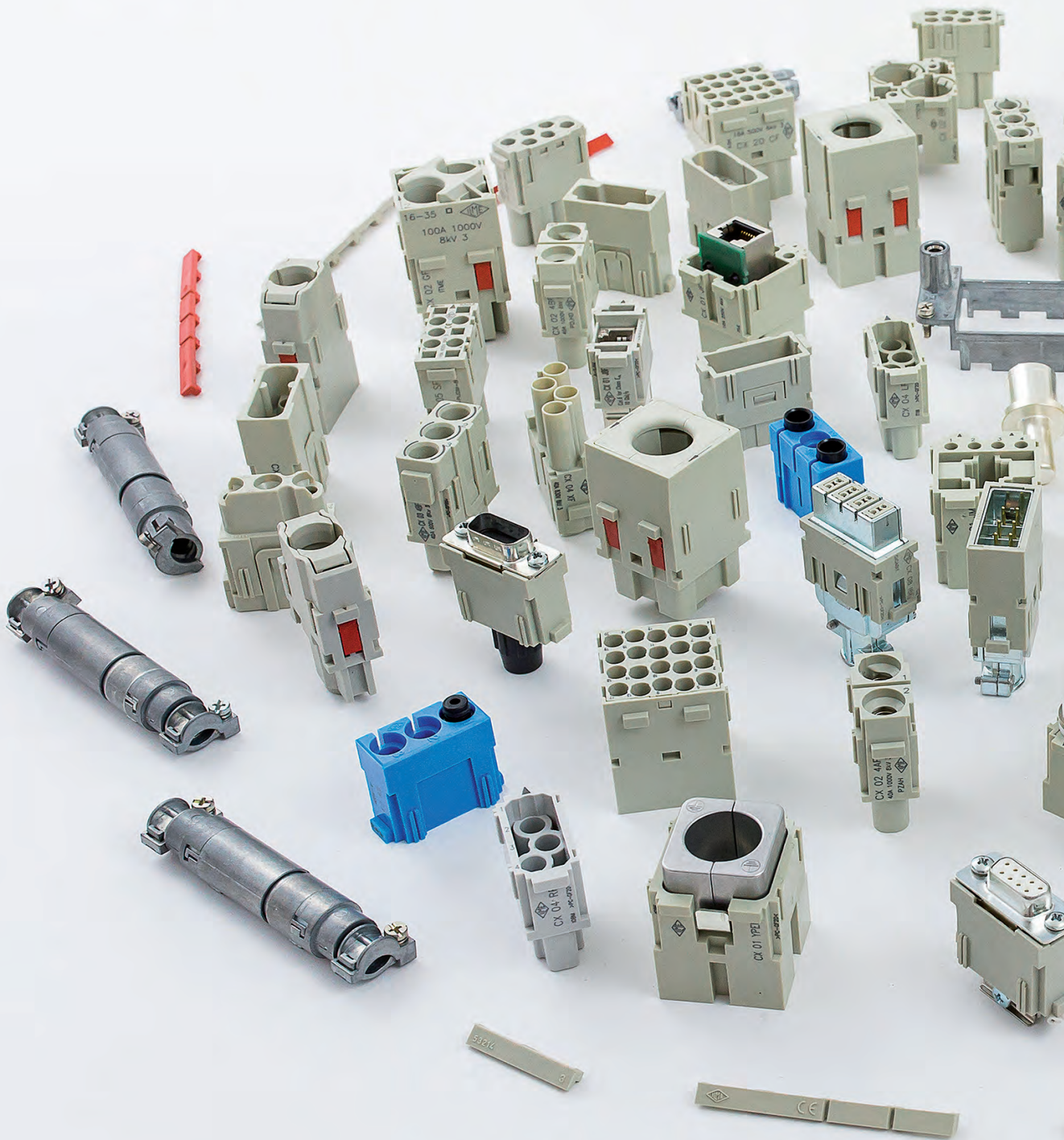


- HNM frames

From page..... 333

BUILD YOUR CONNECTOR

MIXO INSERTS





MIXO INSERTS

MIXO SERIES

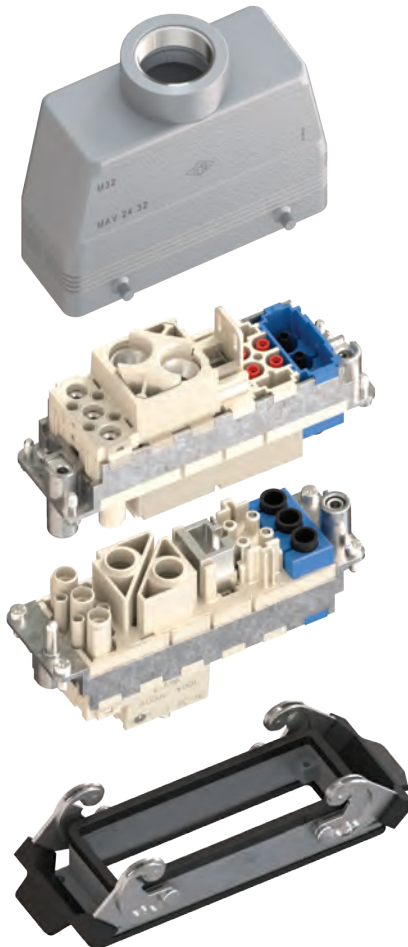
GENERAL OVERVIEW

The MIXO series is a system of modular units for special applications that uses the traditional ILME enclosures. Each enclosure can house different types of connections such as: electric signals and contacts for the conduction of compressed air with pressure values of up to 8 bars.

The inserts are arranged side by side to form a single **compact block** which is inserted into metallic frames with constrained positioning. Once the modules have been inserted and locked with the special tabs, the connector can be placed into the enclosure.

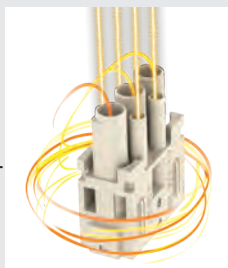
The modular system makes it easy to access a series of contacts inserted in the frame (e.g., for substitution, check or the addition of signals with new inserts for needs not foreseen during the initial installation) without having to disassemble the entire connector.

ILME MIXO series of modular connectors is an open connector system that provides versatile configuration to the users' individual requirements, giving the **freedom to assemble a customized connector** from a range of over 40 modules for power electrical, data transmission, optical signals or air. The module range is continuously expanded, allowing new configurations to be realised.

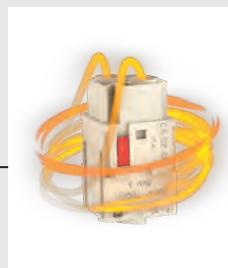


The use of enclosures provides the possibility of innumerable **applications.**

POWER/
SIGNAL



POWER



DATA
TRANSMISSION



FIBRE OPTIC

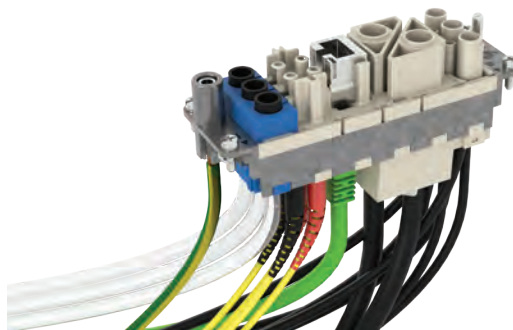


PNEUMATIC



The MIXO series can be used with **5 different frame sizes**:

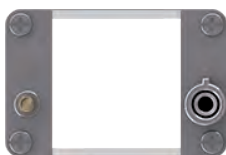
Frames	one or two-lever metallic enclosures
CX 01 T	size "49.16"
CX 02 TM/TF	size "44.27"
CX 03 TM/TF	size "57.27"
CX 04 TM/TF	size "77.27"
CX 06 TM/TF	size "104.27"
CX 04 TM/TF (x 2)	size "77.62"
CX 06 TM/TF (x 2)	size "104.62"



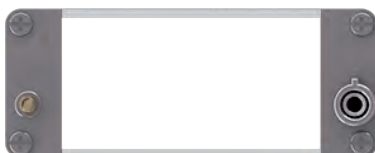
CX 01 T
1 module



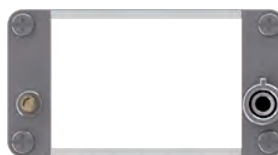
CX 02 TF/TM
2 modules



CX 04 TF/TM
4 modules



CX 03 TF/TM
3 modules



CX 06 TF/TM
6 modules



Possibility – to be verified case-by-case – to use the recently added MIXO **HNM frames** (provided with special gold plated PE contacts) together with R series of crimp contacts and the relevant

connector hoods and housings, to produce, where required, an **HNM connector** (High Number of Matings, up to 10.000 cycles of operation). For more information refer to page 333

Fill the unused frame slots with **CX FM dummy module**



In addition, the MIXO series can be used with the **COB series panel supports**.

Frames	COB panel supports part No.
CX 02 TM/TF	fixed: COB 06 BC and COB TCQ mobile: COB TSF, COB TSFS and COB 06 CMS
CX 03 TM/TF	fixed: COB 10 BC and COB TCQ mobile: COB TSF, COB TSFS and COB 10 CMS

Frames	COB panel supports part No.
CX 04 TM/TF	fixed: COB 16 BC and COB TCQ mobile: COB TSF, COB TSFS and COB 16 CMS
CX 06 TM/TF	fixed: COB 24 BC and COB TCQ mobile: COB TSF, COB TSFS and COB 24 CMS

THE COMPLETE RANGE

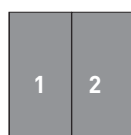
Inserts	Contact type	Signal type	Kind of connection	Rated current (A)	Rated voltage (V)	No. of frame slots	HNM suitable
CX 01 YF/M	main	electric	crimp	200	1000	2	—
CX 01 YPEF/M	PE	—	crimp	200	—	2	—
CX 01 GF/M	main	electric	crimp	100	830	1	—
CX 02 GF/M	main	electric	crimp	100	1000	2	—
CX 02 7F/M	main	electric	crimp	70	1000	1	—
CX 02 4AF/M	main	electric	axial screw	40	1000	1	—
CX 02 4BF/M	main	electric	axial screw	40	1000	1	—
CX 02 4F/M	main	electric	crimp	40	1000	1	—
CX 03 4F/M	main	electric	crimp	40	400/690	1	yes
CX 03 4BF/BM	main	electric	crimp	40	500	1	yes
CX 3/4 XDF/M	main / auxiliary	electric	crimp	40/10	830	1	—
CX 04 XF/M	main	electric	crimp	40	830	1	yes
CX 05 SF/M ▲	main	electric	spring	16	400	1	—
CX 05 SHF/M	main	electric	SQUICH®-spring	16	400	1	—
CX 06 CF/M	main	electric	crimp	16	500	1	yes
CX 06P CF/M	main	electric	crimp	16	830	1	yes
CX 08 CF/M	main	electric	crimp	16	400	1	yes
CX 08 I6F/M	main + shield	electric	crimp	5	50	1	—
CX 20 CF/M	main	electric	crimp	16	500	2	yes
CX 12 DF/M	main / auxiliary	electric	crimp	10	250	1	yes
CX 17 DF/M	main / auxiliary	electric	crimp	10	160	1	yes
CX 42 DF/M	main / auxiliary	electric	crimp	10	150	2	yes
CX 25 IBF/M	main / auxiliary	electric	crimp	4	50	1	—
CX 25 IF/M ▲	main / auxiliary	electric	crimp	4	50	1	—
CX 02 CHF/M	main	electric	crimp	16	2500	1	—
CX 02 HF/M	main	electric	crimp	16	2900/5000	2	—
CX 02 BF/M	seat for two shielded connectors (refer to CX 04 B, CX 01 B, CX 01 BC, CX 08 B)					2	—
CX 01 BCF/M	main / auxiliary + shield	electric	crimp	16	50	—	—
CX 01 BF/M	main / auxiliary + shield	electric	crimp	10	50	—	—
CX 04 BF/M	main / auxiliary + shield	electric	crimp	10	50	—	—
CX 08 BF/M	main / auxiliary + shield	electric	crimp	5	50	—	—
CX 03 P	pneumatic Ø 1,6 - 3,0 - 4,0 mm	air	snap-in	—	—	1	—
CX 02 P	pneumatic Ø 6,0 mm	air	snap-in	—	—	1	—
CX FM	none (dummy module)	—	—	—	—	1	yes
CX 01 J8F/M/IM	RJ45	electric	crimp/IDC	—	—	1	—
CX 01 JF/M	RJ45 + auxiliary	electric	crimp	10	250	2	—
CX 02 JF/M	RJ45 + auxiliary	electric	crimp	10	250	3	—
CX 01 UF/M	USB	electric	—	—	—	1	—
CX 01 9VF/M	D-SUB	electric	crimp	5	50	1	—
CX 01 9VTF	D-SUB	electric	screw	5	50	1	—
CX 04 LF/M	POF / MOST	optic	crimp	—	—	1	—
CX 04 RF/M	coaxial	electric	crimp	—	—	1	—
CX 04 SCF/M	SC fibre optic	optic	crimp/glue	—	—	1	—

▲ Available upon request

Calculate the number of frame slots taken up by the required inserts (frame slot 1, 2 or 3 modules) and select the right frame according to the number of required modules (available 1, 2, 3, 4 and 6 modules).



size: 1 frame slot



size: 2 frame slots



size: 3 frame slots

THE 41-VARIANT RANGE OF CHOICE

ILME MIXO portfolio includes a series of key modular units being continuously widened:

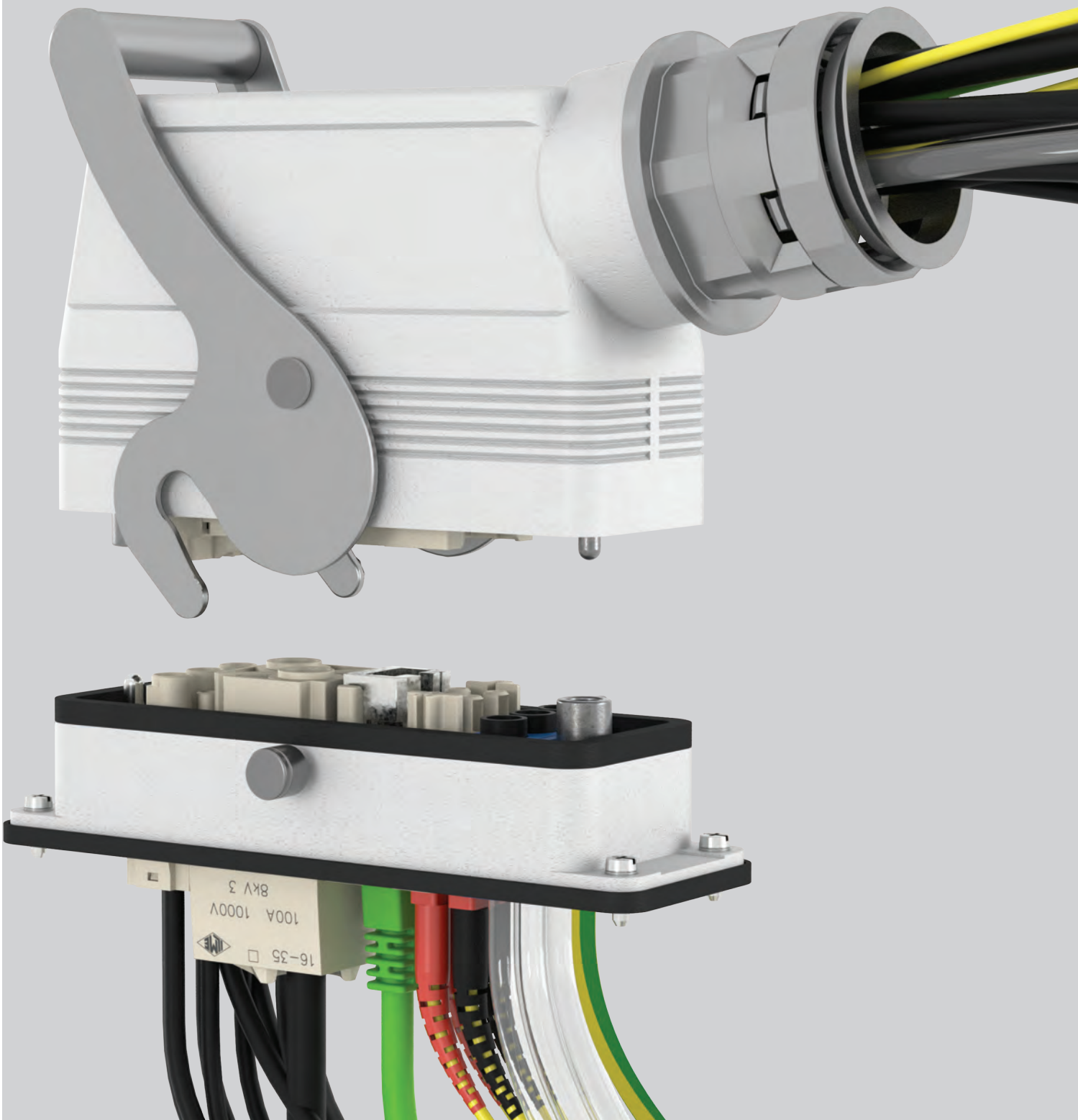
23 modules	for electric power and signal transmission with contacts for rated current up to:
- 2 module for 200A	with CX 01 YF/YM and CX 01 YPEF/YPEM (for PE connection) (crimp)
- 2 modules for 100A	with CX 02 GF/GM and CX 01 GF/GM (crimp)
- 1 module for 70A	with CX 02 7F/7M (crimp)
- 7 modules for 40A	with CX 02 4F/4M (crimp), CX 02 4AF/4AM and CX 02 4BF/4BM (axial screw), with CX 03 4F/4M and CX 03 4BF/4BM (crimp), CX 3/4 XDF/XDM (crimp), CX 04 XF/XM (crimp)
- 6 modules for 16A	with CX 05 SF/SM ▲ (spring clamp), CX 05 SHF/SHM (SQUICH®), CX 06P CF/CM, CX 06 CF/CM, CX 08 CF/CM, CX 20 CF/CM
- 3 modules for 10A	with CX 12 DF/DM (crimp), CX 17 DF/DM (crimp), CX 42 DF/DM (crimp)
- 2 modules for 4A	with CX 25 IF/IM ▲ and CX 25 IBF/IBM (crimp)
2 modules	for high voltage connections 16A – 2,9/5,0 kV with CX 02 HF/HM and 2,5 kV with CX 02 CHF/ CHM
4 MIXO-BUS	shielded connectors for bus data transmission:
- 1 module CX 02 BF/BM	for two shielded connectors to be chosen among the following 4 options:
1. CX 01 BF/BM	coaxial, 10A (crimp) – 75 Ω characteristic impedance
2. CX 01 BCF/BCM	coaxial, 16A (crimp) – 50 Ω characteristic impedance
3. CX 04 BF/BM	quad-axial 10A (crimp)
4. CX 08 BF/BM	8-ways 5A (crimp)
3 modules/adapters	for RJ-45:
- CX 01 J8F/J8M/J8IM	single-sized module for 1 RJ-45 patch cord, female module is a “gender changer”
- CX 01 JF/JM	double-sized module for 1 RJ-45 patch cord + 4 auxiliary 10A (crimp) contacts
- CX 02 JF/JM	triple-sized module for 2 RJ-45 patch cords + 8 auxiliary 10A (crimp) contacts
1 module	for Gigabit Ethernet , with CX 08 I6F/ I6M, 5A (crimp) and relevant accessories
1 module/adapter	for USB:
	male adapter for USB patch cord
	female adapter is a F/F “gender changer”, for rear connection to a male USB patch cord with CX 01 UF/UM
2 modules	with D-Sub 9-pole with CX 01 9VF/9VM, 5A (crimp) and CX 01 9VTF (for RS-485 T-connection)
2 modules	for pneumatic quick-couplings with CX 02 P and CX 03 P
3 modules	for fibre optic (POF or MOST® or SC) or coaxial crimp contacts (50 Ω or 75 Ω characteristic impedance) with CX 04 LF/LM, CX 04 RF/RM and CX 04 SCF/SCM

In addition to:

- 5 frames** for the build-up of a modular connector.
The connector consists of a multiple number of the above listed single-sized and/or double-sized modular units and/or triple-sized modules; 4 +1 frames in particular fit the main housing sizes:
- “44.27” for 2 single-sized modules or 1 double-sized module;
 - “57.27” for 3 single-sized modules or a combination of 1 single-sized module or 1 double-sized module, or 1 triple-sized module;
 - “77.27” for 4 single-sized modules, 2 double-sized modules, 1 triple-sized module and 1 single-sized module, or a combination of 2 single-sized modules or 1 double-sized module;
 - “104.27” for 6 single-sized modules, 4 single-sized modules and 1 double-sized module, 2 single-sized modules and 2 double-sized modules, 3 double-sized modules, 2 triple-sized modules, 1 triple-sized module and 1 double-sized module and 1 single-sized module, or 1 triple-sized module and 3 single-sized modules.

1 frame for the build-up of 1 single-sized module in connector housings size “49.16”.

The frame range allows the build-up of 7 different sizes of multipole modular connectors (this because 2 frames each of sizes “77.27” and “104.27” may be additionally combined in the double-sized “77.62” and “104.62” connector housings).

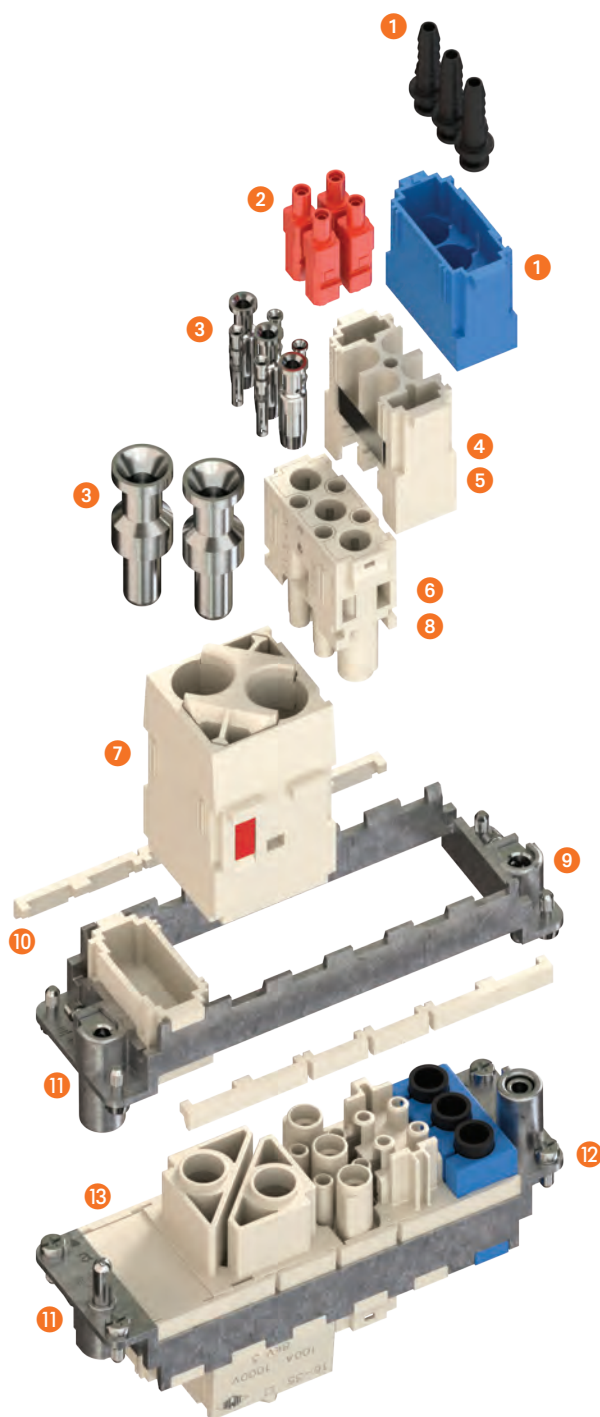


TECHNICAL CHARACTERISTICS

- 1 Pneumatic contacts in plastic with hose barb connection.
- 2 Fibre optic contacts SC type.
- 3 Electric contacts in silver-plated or gold-plated brass with connections to the conductors via crimping, spring clamp or axial screw.
- 4 Modular inserts of identical size with insertion system for forming the complete module and frame lock tab.
- 5 Inserts in self-extinguishing thermoplastic material, reinforced with glass fibre, UL 94V-0 approved, with a working temperature range of -40 °C to +125 °C.
- 6 Inserts in conformance with the requirements of the EN 61984 standard and certified and marked with the UL, CSA, CQC, DNV-GL, BV, EAC marks.
- 7 Inserts with patented "swallowtails" to prevent incorrect coupling.
- 8 Position of contacts identified with numbers or codes on both sides of every insert.
- 9 Male/female module carrier frames with mandatory housings and polarity, in die-cast zinc alloy.
- 10 Module lock tab, may be divided according to the number of modules used; it guarantees a perfect stability of the modules during wiring and coupling/uncoupling of the connectors.
- 11 Asymmetric protective earth contacts (two per frame) with wide contact surface to prevent incorrect coupling; when two or more identical connectors of the MIXO series are used, coded pins may prevent incorrect coupling (refer to pages 684, 685 and 689).
- 12 Captive frame fastening screws, with spring washer.
- 13 Dummy module for unused frame slots.

ADVANTAGES

- ☑ Easy and user-friendly assembly of the complete multi-module insert before fixing it on the relevant sized metal frame;
- ☑ use of proprietary ILME technology providing each module with "swallowtails" (lateral keys/keyways), for reciprocal locking of modules and overall assembly of the insert into rigid (non hinged) frames with snap-in locking strips;
- ☑ faster and easier assembly compared with competitor solutions (easier handling of modules as a complete block than e.g. 6 independent parts);
- ☑ intermateability at "complete connector" (modules in frame) with other industry standard products;
- ☑ robust and long lasting prevailing crimp connection technology (largely preferred over screw type technology in high vibration and shock environments).



Watch our
MIXO & MATCH
video

CX 01 YF/YM 1 pole 200A - 1000V

The modular inserts must be installed in suitable frames, which are then mounted in traditional enclosures* or in COB panel supports.

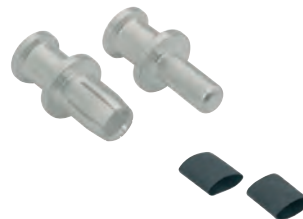
frames for modular units*

page: 317

modular units, crimp connections



200A silver plated crimp contacts heat shrink tube



* enclosures: housings or high construction hoods

description	part No.	part No.
-------------	----------	----------

without contacts (to be ordered separately)
female inserts for female contacts
male inserts for male contacts

CX 01 YF
CX 01 YM

200A female crimp contacts

16 mm ²	AWG 6	one groove (back side)
25 mm ²	AWG 4	with no grooves
35 mm ²	AWG 2	one groove
50 mm ²	AWG 1	two grooves
70 mm ²	AWG 2/0	with no grooves

CYFA 16
CYFA 25
CYFA 35
CYFA 50
CYFA 70

silver plated

200A male crimp contacts

16 mm ²	AWG 6	one groove (back side)
25 mm ²	AWG 4	with no grooves
35 mm ²	AWG 2	one groove
50 mm ²	AWG 1	two grooves
70 mm ²	AWG 2/0	with no grooves

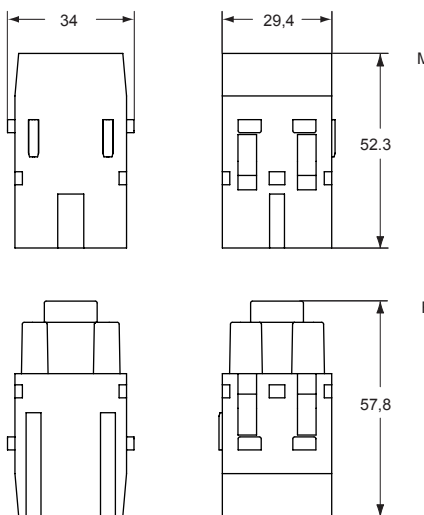
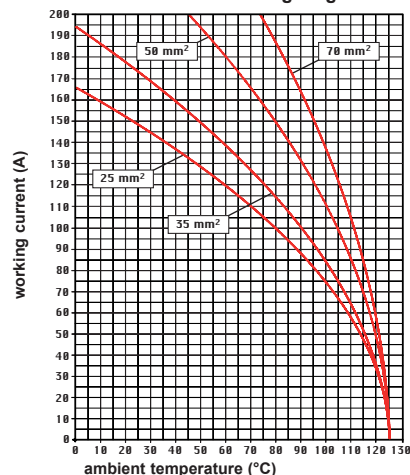
CYMA 16
CYMA 25
CYMA 35
CYMA 50
CYMA 70

heat shrink tube for CYFA/CYMA 16 contacts or for conductor with total external Ø < 10 mm

CR TT

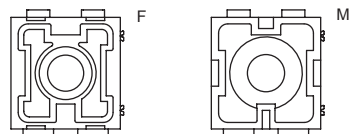
- characteristics according to EN 61984:
200A 1000V 8kV 3
200A 920/1600V 8kV 2
- cULus (UL for USA and Canada),
- certified
- rated voltage according to UL/CSA: 600V
- insulation resistance: ≥ 10 GΩ
- ambient temperature limit: -40 °C ... +125 °C
- made of self-extinguishing thermoplastic resin UL 94V-0
- mechanical life: ≥ 500 cycles
- contact resistance: ≤ 0,2 mΩ
- **it is recommended to crimp the contacts with crimping tools homologated by ILME** (please see the crimping tool section 200A contacts, CYF and CYM series) on pages 708 - 741
- for max. current load see the connector inserts derating diagram below; for more information see page 28

CX 01 Y, 1 pole connector inserts (MIXO 200A)
Maximum current load derating diagram

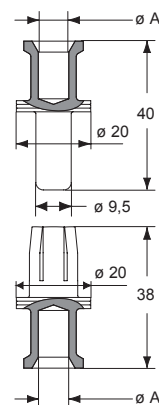


contacts side (front view)

side with reference arrow ▲



- 2 frame slots



CYF and CYM contacts

conductor section (mm ²)	conductor slot (mm)	conductor stripping length (mm)
16	6,1	15
25	7,0	15
35	8,2	15
50	9,8	15
70	11,8	15

MIXO INSERTS

CX 01 YPEF/YPEM 1 PE pole 200A

The modular inserts must be installed in suitable frames, which are then mounted in traditional enclosures* or in COB panel supports.

frames for modular units*

page:
317

modular units, crimp connections
PE module for earth termination



200A silver plated crimp contacts



* enclosures: housings or high construction hoods

description	part No.	part No
-------------	----------	---------

without contacts (to be ordered separately)
PE female inserts for female contacts
PE male inserts for male contacts

CX 01 YPEF
CX 01 YPEM

200A female crimp contacts

16 mm ²	AWG 6	one groove (back side)
25 mm ²	AWG 4	with no grooves
35 mm ²	AWG 2	one groove
50 mm ²	AWG 1	two grooves
70 mm ²	AWG 2/0	with no grooves

CYFA 16
CYFA 25
CYFA 35
CYFA 50
CYFA 70

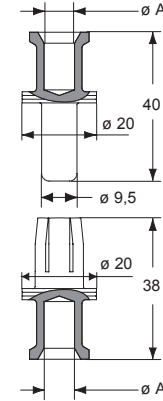
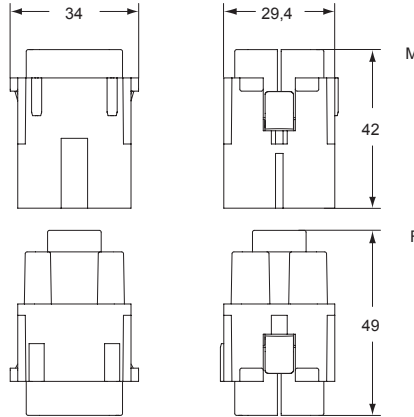
silver plated

200A male crimp contacts

16 mm ²	AWG 6	one groove (back side)
25 mm ²	AWG 4	with no grooves
35 mm ²	AWG 2	one groove
50 mm ²	AWG 1	two grooves
70 mm ²	AWG 2/0	with no grooves

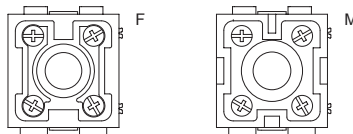
CYMA 16
CYMA 25
CYMA 35
CYMA 50
CYMA 70

- cULus (UL for USA and Canada), SB, cec, DNV-GL
- EAC certified
- ambient temperature limit: -40 °C ... +125 °C
- made of self-extinguishing thermoplastic resin UL 94V-0
- mechanical life: ≥ 500 cycles
- contact resistance: ≤ 0,2 mΩ
- **it is recommended to crimp the contacts with crimping tools homologated by ILME** (please see the crimping tool section 200A contacts, CYF and CYM series) on pages 708 - 741



contacts side (front view)

side with reference arrow ▲



- 2 frame slots

CYF and CYM contacts

conductor section ø A (mm ²)	conductor slot (mm)	conductor stripping length (mm)
16	6,1	15
25	7,0	15
35	8,2	15
50	9,8	15
70	11,8	15

CX 01 GF/GM 1 pole 100A - 830V

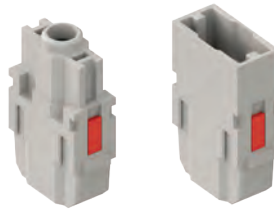
The modular inserts must be installed in suitable frames which are then mounted in traditional enclosures* or in COB panel support.
Single-sized modular units may be directly mounted inside MIXO ONE enclosures.

frames for modular units* page: 316 - 317

MIXO ONE enclosures 369

* enclosures: bulkhead mounting housings, high construction housings or high construction hoods

modular units,
crimp connections



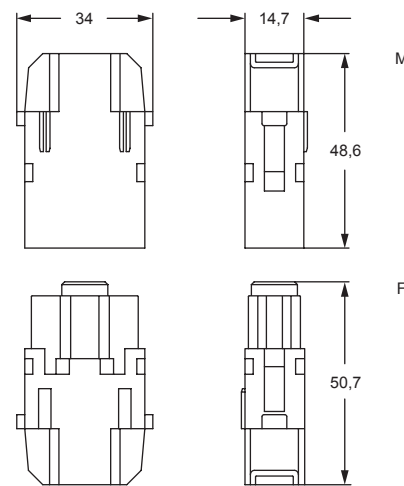
100A silver plated crimp contacts,
PE adapter



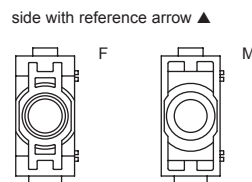
description	part No.	part No.
without contacts (to be ordered separately)		
female inserts for female contacts	CX 01 GF	
male inserts for male contacts	CX 01 GM	
100A female crimp contacts		CGFA 10
8-10 mm ² AWG 8-7		CGFA 16
16 mm ² AWG 6-5		CGFA 25
25 mm ² AWG 4-3		CGFA 35
35 mm ² AWG 2		
100A male crimp contacts		CGMA 10
8-10 mm ² AWG 8-7		CGMA 16
16 mm ² AWG 6-5		CGMA 25
25 mm ² AWG 4-3		CGMA 35
35 mm ² AWG 2		
cable earthing adapter 16 mm ² (AWG 6-5)		CGT 16

silver plated

- characteristics according to EN 61984:
- 100A 830V 8kV 3**
- certified
- rated voltage according to UL/CSA: 600V
- insulation resistance: ≥ 10 GΩ
- ambient temperature limit: -40 °C ... +125 °C
- made of self-extinguishing thermoplastic resin UL 94V-0
- mechanical life: ≥ 500 cycles
- contact resistance: ≤ 0,3 mΩ
- **it is recommended to crimp the contacts with crimping tools homologated by ILME** (please see the crimping tool section 100A contacts, CGF and CGM series) on pages 708 - 741
- contact removal only using a screwdriver
- for max. current load see the connector inserts derating diagram below; for more information see page 28



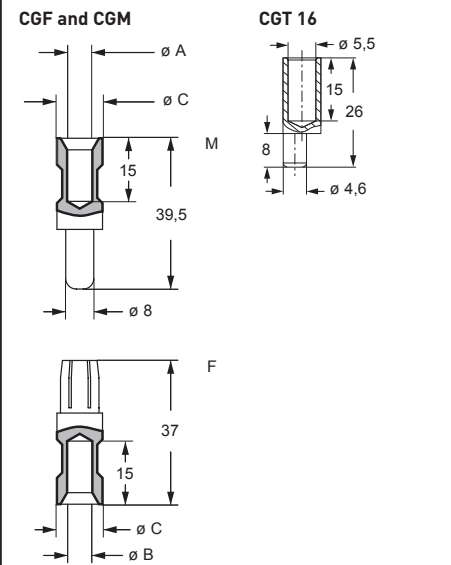
contacts side (front view)



- 1 frame slot



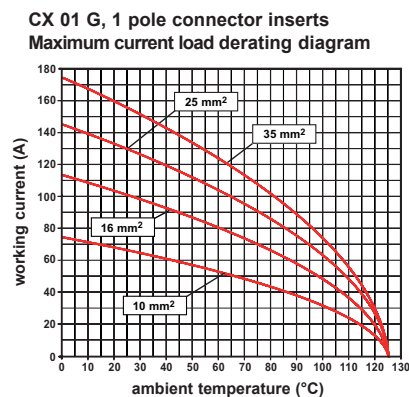
Watch our online tutorial



CGF and CGM contacts				
conductor section (mm ²)	conductor ø A (mm)	conductor slot ø B (mm)	conductor ø C (mm)	conductor stripping length (mm)
8-10	4,3	4,3	13	15
16	5,5	5,5	13	15
25	7,0	7,0	13	15
35	7,9	8,2	12,5	15

How to use the PE adapter (CGT 16):

- 1) Strip 15 mm of flexible PE protective cable
- 2) Crimp the cable on the CGT 16 adapter by using the CGPZ pliers with the CGD 16 C matrix
- 3) Fix the adapter tip in the larger earth terminal (6 mm²) of frames CX...TM/TF
- 4) To be used with bulkhead mounting housings or high construction hoods
- 5) Cannot be used with T-TYPE series



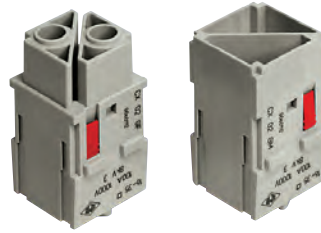
CX 02 GF/GM 2 poles 100A - 1000V

The modular inserts must be installed in suitable frames, which are then mounted in traditional enclosures* or in COB panel supports.

frames for modular units*

page:
317

modular units,
crimp connections



100A silver plated crimp contacts,
PE adapter



* enclosures: bulkhead mounting housings, high construction housings or high construction hoods

description	part No.	part No.
without contacts (to be ordered separately)		
female inserts for female contacts ¹⁾	CX 02 GF	
male inserts for male contacts ¹⁾	CX 02 GM	
100A female crimp contacts		CGFA 10
8-10 mm ² AWG 8-7		CGFA 16
16 mm ² AWG 6-5		CGFA 25
25 mm ² AWG 4-3		CGFA 35
35 mm ² AWG 2		
100A male crimp contacts		CGMA 10
8-10 mm ² AWG 8-7		CGMA 16
16 mm ² AWG 6-5		CGMA 25
25 mm ² AWG 4-3		CGMA 35
35 mm ² AWG 2		
cable earthing adapter 16 mm ² (AWG 6-5)		CGT 16

silver plated

¹⁾ on request, version with pole 3/4 numbering, references: **CX 02 GFN, CX 02 GMN**

- characteristics according to EN 61984:

100A 1000V 8kV 3
100A 920/1600V 8kV 2

- cULus (UL for USA and Canada),

ERC certified

- rated voltage according to UL/CSA: 600V

- insulation resistance: $\geq 10 \text{ G}\Omega$

- ambient temperature limit: -40 °C ... +125 °C

- made of self-extinguishing thermoplastic resin UL 94V-0

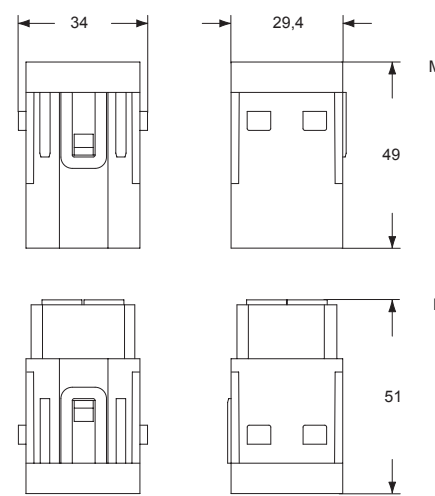
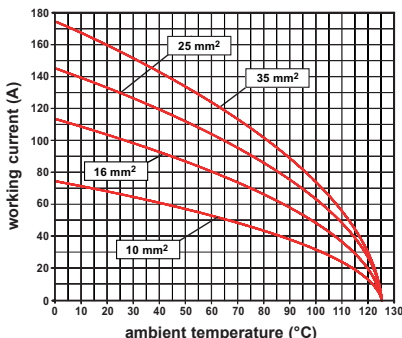
- mechanical life: ≥ 500 cycles

- contact resistance: $\leq 0,3 \text{ m}\Omega$

- **it is recommended to crimp the contacts with crimping tools homologated by ILME** (please see the crimping tool section 100A contacts, CGF and CGM series) on pages 708 - 741

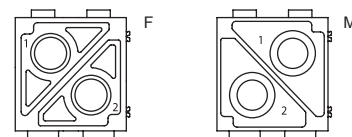
- for max. current load see the connector inserts derating diagram below; for more information see page 28

CX 02 G, 2 poles connector inserts
Maximum current load derating diagram



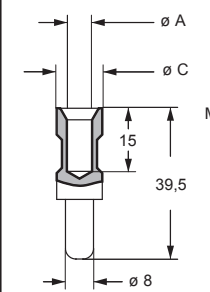
contacts side (front view)

side with reference arrow ▲

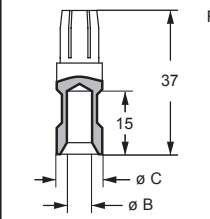
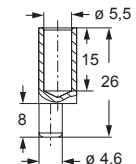


- 2 frame slots

CGF and CGM



CGT 16



CGF and CGM contacts

conductor section (mm ²)	conductor slot ø A (mm)	conductor slot ø B (mm)	conductor slot ø C (mm)	conductor stripping length (mm)
8-10	4,3	4,3	13	15
16	5,5	5,5	13	15
25	7,0	7,0	13	15
35	7,9	8,2	12,5	15

How to use the PE adapter (CGT 16):

- 1) Strip 15 mm of flexible PE protective cable
- 2) Crimp the cable on the CGT 16 adapter by using the CGPZ pliers with the CGD 16 C matrix
- 3) Fix the adapter tip in the larger earth terminal (6 mm²) of frames CX...TM/TF
- 4) To be used with bulkhead mounting housings or high construction hoods
- 5) Cannot be used with T-TYPE series

CX 02 7F/7M 2 poles 70A - 1000V

The modular inserts must be installed in suitable frames which are then mounted in traditional enclosures* or in COB panel support.
Single-sized modular units may be directly mounted inside MIXO ONE enclosures.

frames for modular units*	page: 317
MIXO ONE enclosures	369

* enclosures: bulkhead mounting housings, high construction housings or high construction hoods

modular units, crimp connections



70A silver plated crimp contacts



description	part No.	part No.
-------------	----------	----------

without contacts (to be ordered separately)
female inserts for female contacts
male inserts for male contacts

CX 02 7F
CX 02 7M

70A female crimp contacts
10 mm² AWG 8 - 7
16 mm² AWG 6 - 5
25 mm² AWG 4 - 3

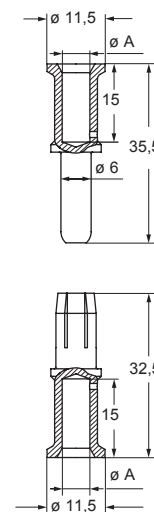
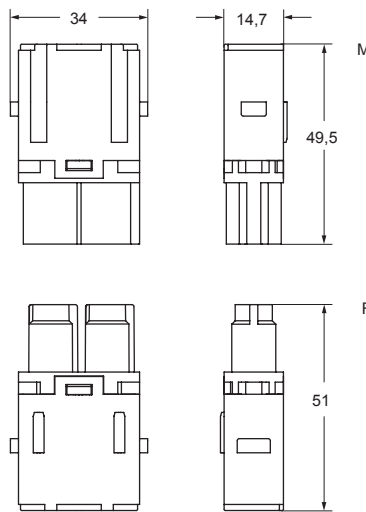
CX7FA 10
CX7FA 16
CX7FA 25

silver plated

70A male crimp contacts
10 mm² AWG 8 - 7
16 mm² AWG 6 - 5
25 mm² AWG 4 - 3

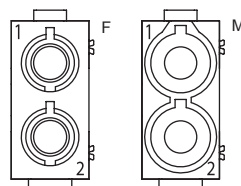
CX7MA 10
CX7MA 16
CX7MA 25

- characteristics according to EN 61984:
70A 1000V 8kV 3
70A 1600V 12kV 2
- (UL for USA and Canada), certified
- rated voltage according to UL/CSA: 600V
- insulation resistance: ≥ 10 GΩ
- ambient temperature limit: -40 °C ... +125 °C
- made of self-extinguishing thermoplastic resin UL 94V-0
- mechanical life: ≥ 500 cycles
- contact resistance: ≤ 0,5 mΩ
- **it is recommended to crimp the contacts with crimping tools homologated by ILME** (please see the crimping tool section 70A contacts, CX7F and CX7M series) on pages 708 - 741
- **C7ES** removal tool
- for max. current load see the connector inserts derating diagram below; for more information see page 28



contacts side (front view)

side with reference arrow ▲

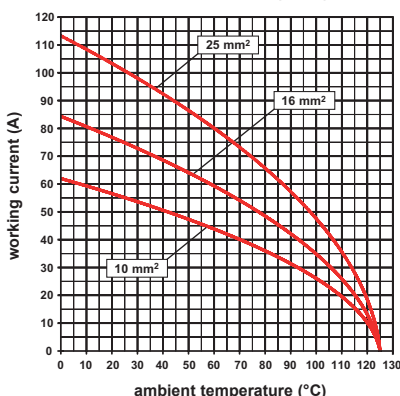


- 1 frame slot

CX7F and CX7M contacts

conductor section (mm ²)	conductor slot ø A (mm)	conductor stripping length (mm)
10	4,3	15
16	5,5	15
25	7,0	15

CX 02 7, 2 poles connector inserts
Maximum current load derating diagram



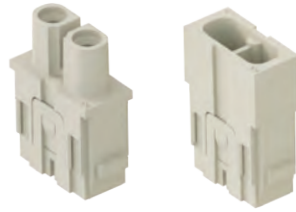
CX 02 4F/4M 2 poles 40A - 1000V

The modular inserts must be installed in suitable frames which are then mounted in traditional enclosures* or in COB panel support.
Single-sized modular units may be directly mounted inside MIXO ONE enclosures.

frames for modular units* page: 316 - 317
MIXO ONE enclosures 369

* enclosures: bulkhead mounting housings, high construction housings or high construction hoods

modular units, crimp connections



40A silver plated crimp contacts



description	part No.	part No.
-------------	----------	----------

without contacts (to be ordered separately)
female inserts for female contacts ¹⁾
male inserts for male contacts ¹⁾

CX 02 4F
CX 02 4M

40A female crimp contacts
1,5 mm² AWG 16
2,5 mm² AWG 14
4 mm² AWG 12
6 mm² AWG 10
10 mm² AWG 8

CXFA 1.5
CXFA 2.5
CXFA 4.0
CXFA 6.0
CXFA 10

silver plated

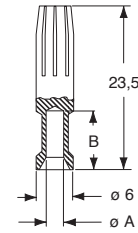
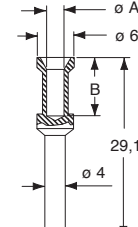
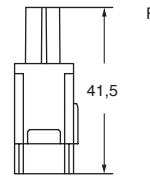
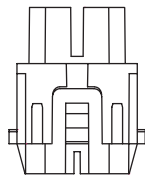
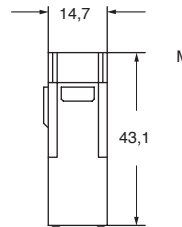
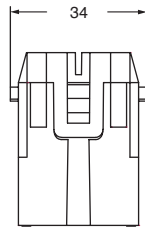
40A male crimp contacts
1,5 mm² AWG 16
2,5 mm² AWG 14
4 mm² AWG 12
6 mm² AWG 10
10 mm² AWG 8

CXMA 1.5
CXMA 2.5
CXMA 4.0
CXMA 6.0
CXMA 10

¹⁾ cable diameter up to 7,5 mm
contact size up to 10 mm²

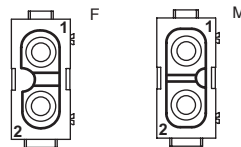
- characteristics according to EN 61984:
40A 1000V 8kV 3

- certified
- rated voltage according to UL/CSA: 600V
- insulation resistance: ≥ 10 GΩ
- ambient temperature limit: -40 °C ... +125 °C
- made of self-extinguishing thermoplastic resin UL 94V-0
- mechanical life: ≥ 500 cycles
- contact resistance: ≤ 0,3 mΩ
- can be mated with CX 02 4A/4B modules
- **it is recommended to crimp the contacts** (1,5 - 10 mm²), **with crimping tools homologated by ILME** (please see the crimping tool section 40A contacts, CXF and CXM series) on pages 708 - 741
- for max. current load see the connector inserts derating diagram below; for more information see page 28



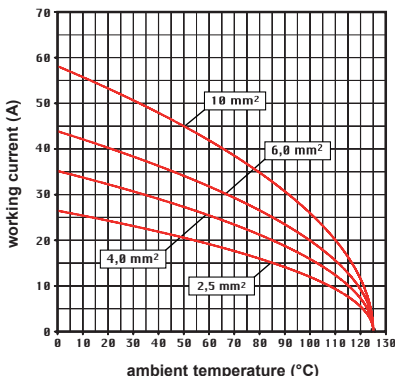
contacts side (front view)

side with reference arrow ▲



- 1 frame slot

CX 02 4, 2 poles connector inserts
Maximum current load derating diagram



CXF and CXM contacts

conductor section (mm ²)	conductor slot ø A (mm)	conductor stripping length B (mm)
1,5	1,8	9
2,5	2,2	9
4	2,85	9,6
6	3,5	9,6
10	4,3	15

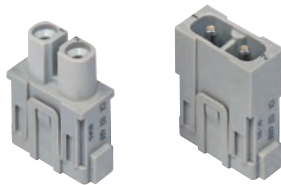
CX 02 4AF/4AM - CX 02 4BF/4BM 2 poles 40A - 1000V

The modular inserts must be installed in suitable frames which are then mounted in traditional enclosures or in COB panel support.
Single-sized modular units may be directly mounted inside MIXO ONE enclosures.

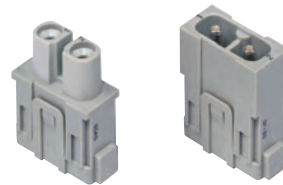
frames for modular units page:
316 - 317

MIXO ONE enclosures 369

modular units,
screw terminal connection
2,5 - 8 mm²



modular units,
screw terminal connection
6 - 10 mm²



description

part No.

part No.

female inserts with female contacts
male inserts with male contacts

CX 02 4AF
CX 02 4AM

female inserts with female contacts
male inserts with male contacts

CX 02 4BF
CX 02 4BM

- use flexible cables with sections from 2,5 to 10 mm² or extra flexible cables with sections from 2,5 to 6 mm²
- do not twist the cables
- fully insert the braids in the rear section of the contact

conductor section (mm ²)	conductor stripping length (mm)	tightening torque (Nm)
2,5	5+1	1,5
4	5+1	1,5
6	8+1	2
10	8+1	2

- insert a 2 mm hexagonal key in the front section of the contact and tighten by keeping the cable held down in position
- a 2 mm hexagonal key can be supplied on request, reference **CX AS**

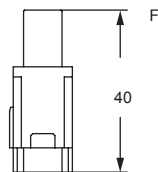
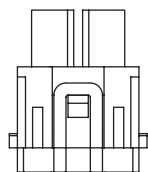
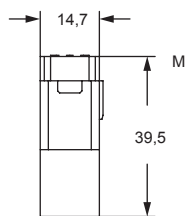
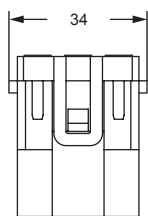
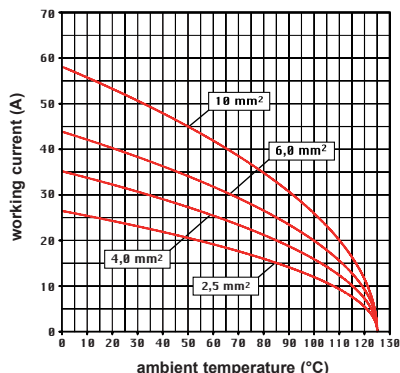


- characteristics according to EN 61984:

40A 1000V 8kV 3
40A 1600V 12kV 2

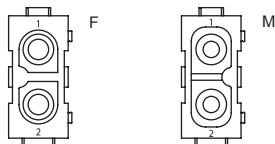
- certified
- rated voltage according to UL/CSA: 600V
- insulation resistance: ≥ 10 GΩ
- ambient temperature limit: -40 °C ... +125 °C
- made of self-extinguishing thermoplastic resin UL 94V-0
- mechanical life: ≥ 500 cycles
- contact resistance: ≤ 0,5 mΩ
- for max. current load see the connector inserts derating diagram below; for more information see page 28

CX 02 4A/B, 2 poles connector inserts
Maximum current load derating diagram

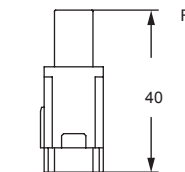
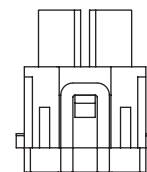
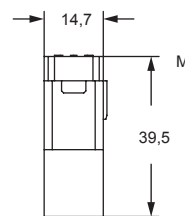
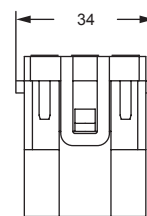


contacts side (front view)

side with reference arrow ▲

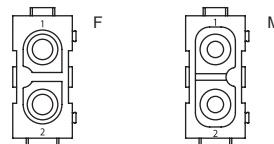


- inserts for Ø 4mm cables, section: 2,5-8 mm² - AWG 14-8
- 1 frame slot



contacts side (front view)

side with reference arrow ▲



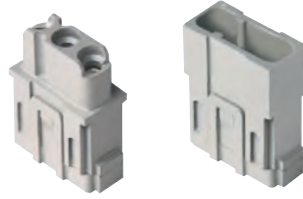
- inserts for Ø 4,8 mm cables, section: 6-10 mm² - AWG 10-8
- 1 frame slot

CX 03 4F/4M 3 poles 40A - 400/690V

The modular inserts must be installed in suitable frames which are then mounted in traditional enclosures or in COB panel support.
Single-sized modular units may be directly mounted inside MIXO ONE enclosures.

frames for modular units page: 316 - 317
MIXO ONE enclosures 369

modular units, crimp connections



40A silver plated crimp contacts



description	part No.	part No.
-------------	----------	----------

without contacts (to be ordered separately)
female inserts for female contacts ¹⁾ **CX 03 4F**
male inserts for male contacts ¹⁾ **CX 03 4M**

40A female crimp contacts
1,5 mm² AWG 16
2,5 mm² AWG 14
4 mm² AWG 12
6 mm² AWG 10

CXFA 1.5
CXFA 2.5
CXFA 4.0
CXFA 6.0

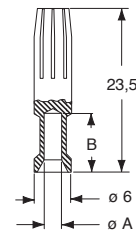
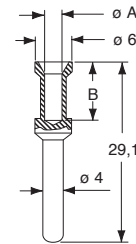
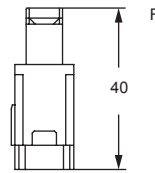
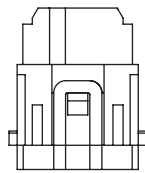
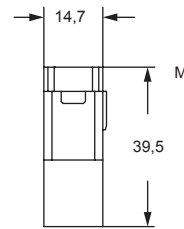
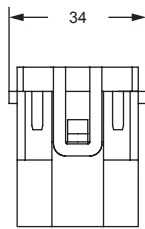
silver plated

40A male crimp contacts
1,5 mm² AWG 16
2,5 mm² AWG 14
4 mm² AWG 12
6 mm² AWG 10

CXMA 1.5
CXMA 2.5
CXMA 4.0
CXMA 6.0

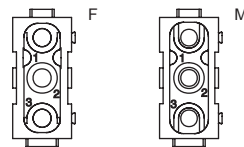
¹⁾ cable diameter up to 5 mm

- characteristics according to EN 61984:
- 40A 400/690V 6kV 3**
- cULus (UL for USA and Canada), certified
- rated voltage according to UL/CSA: 600V
- insulation resistance: ≥ 10 GΩ
- ambient temperature limit: -40 °C ... +125 °C
- made of self-extinguishing thermoplastic resin UL 94V-0
- mechanical life: ≥ 500 cycles
- contact resistance: ≤ 0,3 mΩ
- **it is recommended to crimp the contacts with crimping tools homologated by ILME** (please see the crimping tool section 40A contacts, CXF and CXM series) on pages 708 - 741
- for max. current load see the connector inserts derating diagram below; for more information see page 28



contacts side (front view)

side with reference arrow ▲

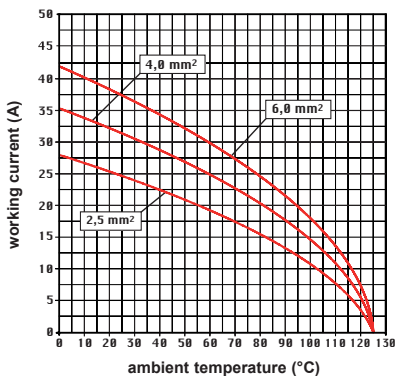


- 1 frame slot

CXF and CXM contacts

conductor section (mm ²)	conductor slot ø A (mm)	conductor stripping length B (mm)
1,5	1,8	9
2,5	2,2	9
4	2,85	9,6
6	3,5	9,6

CX 03 4, 3 poles connector inserts
Maximum current load derating diagram



CX 03 4BF/4BM 3 poles 40A - 500V

The modular inserts must be installed in suitable frames which are then mounted in traditional enclosures* or in COB panel support.

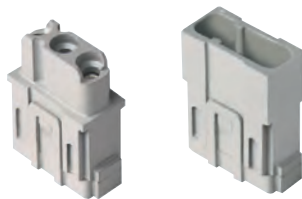
Single-sized modular units may be directly mounted inside MIXO ONE enclosures.

frames for modular units* page: 316 - 317

MIXO ONE enclosures 369

* enclosures: bulkhead mounting housings, high construction housings or high construction hoods

modular units, crimp connections



40A silver plated crimp contacts



description

part No.

part No

without contacts (to be ordered separately)

female inserts for female contacts ¹⁾

male inserts for male contacts ¹⁾

CX 03 4BF
CX 03 4BM

40A female crimp contacts

1,5 mm ²	AWG 16
2,5 mm ²	AWG 14
4 mm ²	AWG 12
6 mm ²	AWG 10
10 mm ²	AWG 8

40A male crimp contacts

1,5 mm ²	AWG 16
2,5 mm ²	AWG 14
4 mm ²	AWG 12
6 mm ²	AWG 10
10 mm ²	AWG 8

CXFA 1.5
CXFA 2.5
CXFA 4.0
CXFA 6.0
CXFA 10

silver plated

CXMA 1.5
CXMA 2.5
CXMA 4.0
CXMA 6.0
CXMA 10

¹⁾ cable diameter up to 7,5 mm
contact size up to 10 mm²

- characteristics according to EN 61984:

40A 500V 6kV 3

- cULus (UL for USA and Canada),

- certified

- rated voltage according to UL/CSA: 600V

- insulation resistance: $\geq 10 \text{ G}\Omega$

- ambient temperature limit: -40 °C ... +125 °C

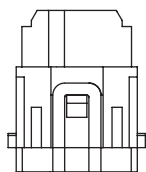
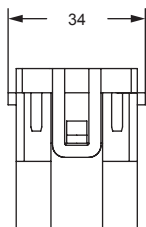
- made of self-extinguishing thermoplastic resin UL 94V-0

- mechanical life: ≥ 500 cycles

- contact resistance: $\leq 0,3 \text{ m}\Omega$

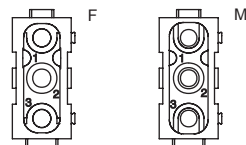
- **it is recommended to crimp the contacts** (1,5 - 10 mm²), **with crimping tools homologated by ILME** (please see the crimping tool section 40A contacts, CXF and CXM series) on pages 708 - 741

- for max. current load see the connector inserts derating diagram below; for more information see page 28

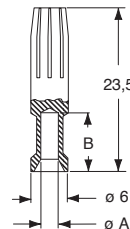
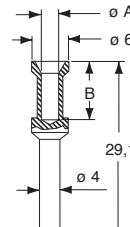
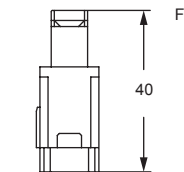
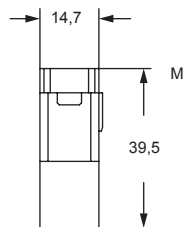


contacts side (front view)

side with reference arrow ▲



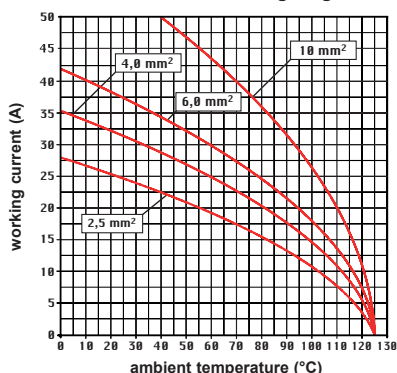
- 1 frame slot



CXF and CXM contacts

conductor section (mm ²)	conductor slot ø A (mm)	conductor stripping length B (mm)
1,5	1,8	9
2,5	2,2	9
4	2,85	9,6
6	3,5	9,6
10	4,3	15

CX 03 4B, 3 poles connector inserts
Maximum current load derating diagram



CX 3/4 XDF/XDM 3 poles (40A - 830V) + 4 poles (10A - 830V)

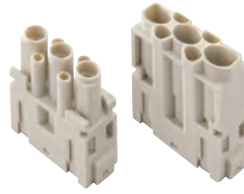
The modular inserts must be installed in suitable frames which are then mounted in traditional enclosures or in COB panel support. Single-sized modular units may be directly mounted inside MIXO ONE enclosures.

page:

frames for modular units 316 - 317
MIXO ONE enclosures 369

- male and female contacts finger proof
- their key characteristic lies in the fact that they guarantee maximum safety even in case of accidental contact with fingers (IP2X or IPXXB). Safety is guaranteed as standard on female contacts, but also on male contacts. This feature is important as it ensures full compliance with the recent safety standard EN 60204-1, concerning electric equipment fitted on machines and in particular with the requirements of Article 6.2.4 concerning protection against residual voltage. In the case of plugs or similar devices, the withdrawal of which results in the exposure of conductors (for example pins), the discharge time shall not exceed 1 s, otherwise such conductors shall be protected against direct contact to at least an IP2X or IPXXB.

modular units, crimp connections



40A and 10A crimp contacts silver and gold plated



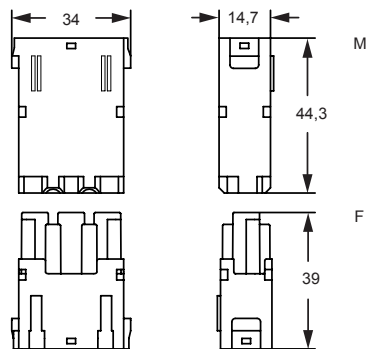
description	part No.	part No.	part No.
without contacts (to be ordered separately)			
female inserts for female contacts	CX 3/4 XDF		
male inserts for male contacts	CX 3/4 XDM		
40A female crimp contacts		CXFA 1.5	
1,5 mm ² AWG 16		CXFA 2.5	
2,5 mm ² AWG 14		CXFA 4.0	
4 mm ² AWG 12		CXFA 6.0	
6 mm ² AWG 10			
40A male crimp contacts		CXMA 1.5	
1,5 mm ² AWG 16		CXMA 2.5	
2,5 mm ² AWG 14		CXMA 4.0	
4 mm ² AWG 12		CXMA 6.0	
6 mm ² AWG 10			
10A female crimp contacts			
0,14-0,37 mm ² AWG 26-22 identification No. 1		CDFA 0.3	CDFD 0.3
0,5 mm ² AWG 20 identification No. 2		CDFA 0.5	CDFD 0.5
0,75 mm ² AWG 18 identification No. ②		CDFA 0.7	CDFD 0.7
1 mm ² AWG 18 identification No. 3		CDFA 1.0	CDFD 1.0
1,5 mm ² AWG 16 identification No. 4		CDFA 1.5	CDFD 1.5
2,5 mm ² AWG 14 identification No. 5		CDFA 2.5	CDFD 2.5
10A male crimp contacts			
0,14-0,37 mm ² AWG 26-22 identification No. 1		CDMA 0.3	CDMD 0.3
0,5 mm ² AWG 20 identification No. 2		CDMA 0.5	CDMD 0.5
0,75 mm ² AWG 18 identification No. ②		CDMA 0.7	CDMD 0.7
1 mm ² AWG 18 identification No. 3		CDMA 1.0	CDMD 1.0
1,5 mm ² AWG 16 identification No. 4		CDMA 1.5	CDMD 1.5
2,5 mm ² AWG 14 identification No. 5		CDMA 2.5	CDMD 2.5

silver plated

+ for basic or high thickness gold plating, please refer to page 674

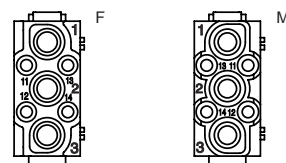
gold plated+

- characteristics according to EN 61984:
- 3 poles 40A 830V 8kV 3**
- 4 poles 10A 830V 8kV 3**
- cULus (UL for USA and Canada),
- certified
- rated voltage according to UL/CSA: 600V
- insulation resistance: ≥ 10 GΩ
- ambient temperature limit: -40 °C ... +125 °C
- made of self-extinguishing thermoplastic resin UL 94V-0
- mechanical life: ≥ 500 cycles
- contact resistance: ≤ 0,3 mΩ (3 poles), ≤ 3 mΩ (4 poles)
- for max. current load see the connector inserts derating diagram below; for more information see page 28



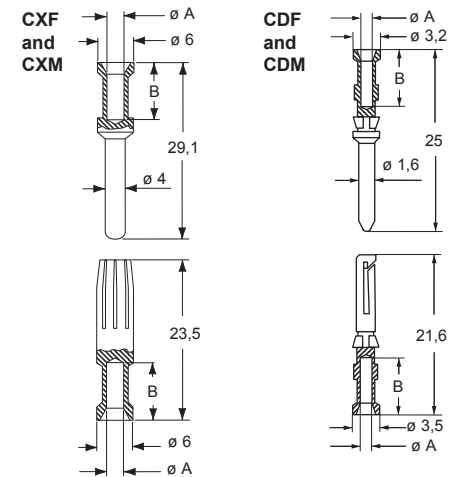
contacts side (front view)

side with reference arrow ▲



- 1 frame slot

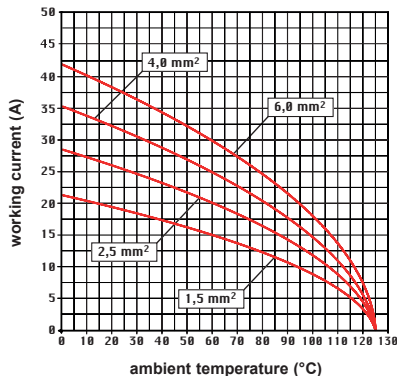
- it is recommended to crimp the contacts with crimping tools homologated by ILME (please see the crimping tool section 40A contacts, CXF, CXM series and 10A contacts CDF, CDM series) on pages 708 - 741



CXF and CXM contacts		
conductor section (mm ²)	conductor slot (mm)	conductor stripping length (mm)
1,5	1,8	9
2,5	2,2	9
4	2,85	9,6
6	3,5	9,6

CDF and CDM contacts		
conductor section (mm ²)	conductor slot (mm)	conductor stripping length (mm)
0,14-0,37	0,9	8
0,5	1,1	8
0,75	1,3	8
1,0	1,45	8
1,5	1,8	8
2,5	2,2	6

CX 3/4 XD, 3/4 poles connector inserts
Maximum current load derating diagram



CX 04 XF/XM 4 poles 40A - 830V

The modular inserts must be installed in suitable frames which are then mounted in traditional enclosures* or in COB panel support.
Single-sized modular units may be directly mounted inside MIXO ONE enclosures.

frames for modular units* page: 316 - 317
MIXO ONE enclosures 369

* enclosures: bulkhead mounting housings, high construction housings or high construction hoods

modular units, crimp connections with red lock-in tab (included)



40A silver plated crimp contacts



description

part No.

part No

without contacts (to be ordered separately)
(module red lock-in tab included)
female inserts for female contacts
male inserts for male contacts

CX 04 XF
CX 04 XM

40A female crimp contacts
1,5 mm² AWG 16
2,5 mm² AWG 14
4 mm² AWG 12
6 mm² AWG 10

CXFA 1.5
CXFA 2.5
CXFA 4.0
CXFA 6.0

40A male crimp contacts
1,5 mm² AWG 16
2,5 mm² AWG 14
4 mm² AWG 12
6 mm² AWG 10

CXMA 1.5
CXMA 2.5
CXMA 4.0
CXMA 6.0

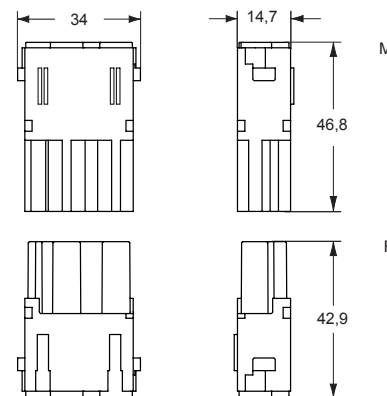
silver plated

- characteristics according to EN 61984:

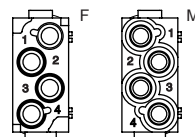
40A 830V 8kV 3
40A 1000V 8kV 2

- cULus (UL for USA and Canada),

- certified
- rated voltage according to UL/CSA: 600V
- insulation resistance: $\geq 10 \text{ G}\Omega$
- ambient temperature limit: $-40 \text{ }^\circ\text{C} \dots +125 \text{ }^\circ\text{C}$
- made of self-extinguishing thermoplastic resin UL 94V-0
- mechanical life: ≥ 500 cycles
- contact resistance: $\leq 0,3 \text{ m}\Omega$
- for spare lock-in tab **CX CFMX** see SPARE SPARTS catalogue
- **it is recommended to crimp the contacts with crimping tools homologated by ILME** (please see the crimping tool section 40A contacts, CXF and CXM series) on pages 708 - 741
- for max. current load see the connector inserts derating diagram below; for more information see page 28

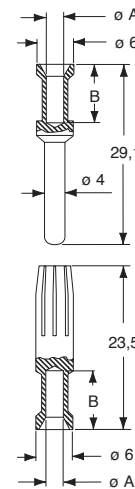
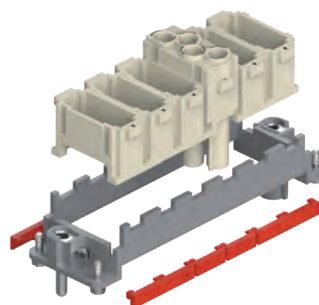


contacts side (front view)
side with reference arrow ▲



- 1 frame slot

Female inserts are supplied with two red lock tab that must be used instead of those supplied with the frames.

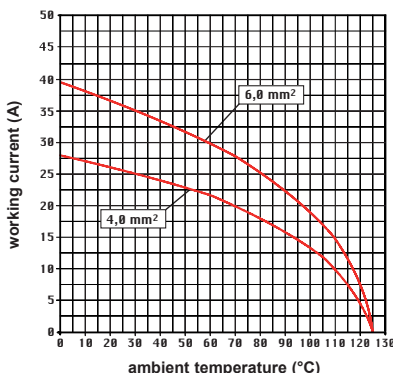


CXF and CXM contacts

conductor section (mm ²)	conductor slot σA (mm)	conductor stripping length B (mm)
1,5	1,8	9
2,5	2,2	9
4	2,85	9,6
6	3,5	9,6

- male and female contacts finger proof
- their key characteristic **lies in the fact that they guarantee maximum safety even in case of accidental contact with fingers (IP2X or IPXXB)**. Safety is guaranteed as standard on female contacts, but also on male contacts. This feature is important as it ensures full compliance with the recent safety standard **EN 60204-1**, concerning electric equipment fitted on machines and in particular with the requirements of Article 6.2.4 concerning protection against residual voltage. **In the case of plugs or similar devices, the withdrawal of which results in the exposure of conductors (for example pins), the discharge time shall not exceed 1 s, otherwise such conductors shall be protected against direct contact to at least an IP2X or IPXXB.**

CX 04 X, 4 poles connector inserts
Maximum current load derating diagram



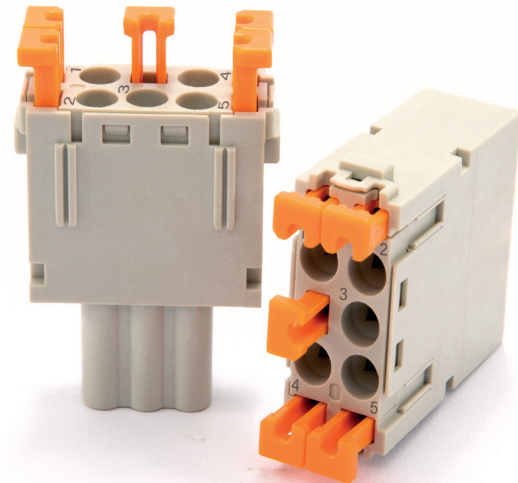
CX 05 SHF/SHM

MIXO - SQUICH®

SQUICH® technology has now been applied to the ILME MIXO series of modular connectors. Main aim is to make wiring an installation easier and safer on every possible connector.

On this purpose, the MIXO SQUICH® 5 poles is the improved version of the CX 05 SF/SM spring clamp module:

- **consistently reduced wiring time**, as the actuator buttons are supplied lifted, in “open terminal” position, so that the stripped wires can be directly inserted;
- **operator skill independence**: thanks to the SQUICH® proprietary technology a simple pressure on the top of the actuator button triggers the locking of the conductor in the terminal, avoiding the need of a specific screwdriver and the relevant skill in its correct choice and application;
- **great resistance to strong vibrations** inherent to self-compensating spring-clamp technology;
- **no special wire preparation** (only stripping at the correct length);
- it allows the **use of both rigid and flexible** copper conductors, with a range of cross-sectional area between 0,14 mm² and 2,5 mm² (26 AWG to 14 AWG);
- for conductors prepared with **crimped ferrules**, the maximum cross-sectional area is 1,5 mm²;
- possibility to insert the **test probe** of a measurement instrument in the dedicated cavity on the actuator button (proprietary design);
- **silver plated** contacts;
- simple re-opening of a terminal (if needed) using a 0,5 x 3 mm flat blade screwdriver on the actuator button dedicated side window (on terminal #3 use the same screwdriver under any of the two lateral projections of the actuator button head; after removing the wire from the relevant terminal #1 or #4).



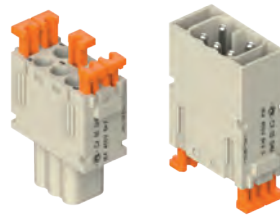
Watch
our
SQUICH®
video

The modular inserts must be installed in suitable frames which are then mounted in traditional enclosures or in COB panel support.
Single-sized modular units may be directly mounted inside MIXO ONE enclosures.

frames for modular units	page: 316
MIXO ONE enclosures	369

- ☑ Suitable for every conductor type (prepared with ferrule, unprepared and solid) up to cross-sectional area 2,5 mm²

modular units,
SQUICH®-spring terminal connection

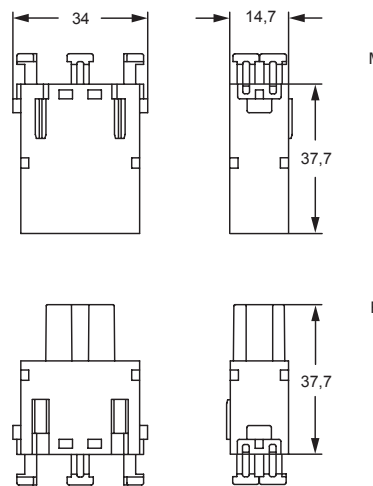


description	part No.
-------------	----------

spring terminals with actuator button
female inserts with female contacts
male inserts with male contacts

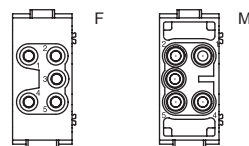
CX 05 SHF
CX 05 SHM

- characteristics according to EN 61984:
- 16A 400V 6kV 3**
- 16A 500V 6kV 2**
- cURus, CSA, CQC, DNV-GL, BV, EAC pending
- rated voltage according to UL/CSA: 600V
- insulation resistance: ≥ 10 GΩ
- ambient temperature limit: -40 °C ... +125 °C
- made of self-extinguishing thermoplastic resin UL 94V-0
- mechanical life: ≥ 500 cycles
- contact resistance: ≤ 3 mΩ
- for max. current load see the connector inserts derating diagram below; for more information see page 28



contacts side (front view)

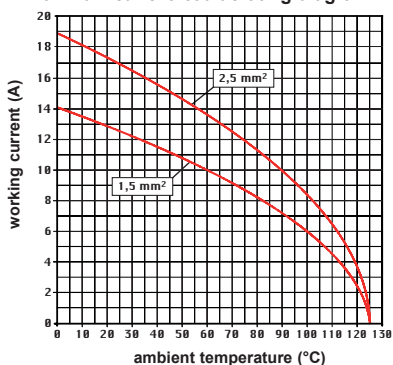
rear view, side with reference arrow ▲



- 1 frame slot

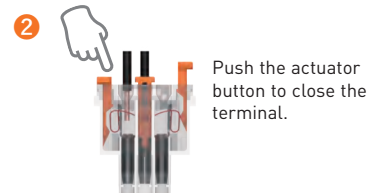
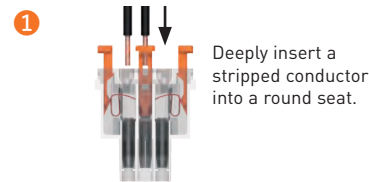
- inserts for cables with the following cross-sectional area: 0,14 - 2,5 mm² - AWG 26 - 14
- conductors stripping length: 9...11 mm

CX 05 SH, 5 power poles connector inserts
Maximum current load derating diagram

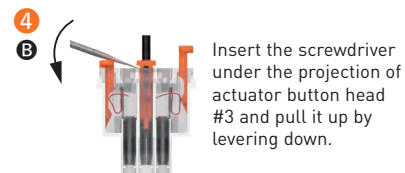
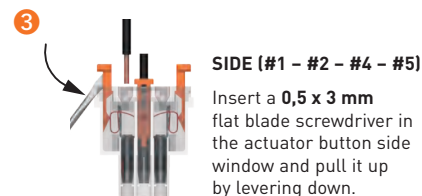


MIXO CX 05 SHF/M
SQUICH®-spring connection technology

WIRING



RE-OPENING



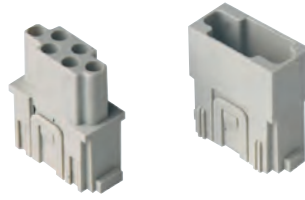
CX 06 CF/CM 6 poles 16A - 500V

The modular inserts must be installed in suitable frames which are then mounted in traditional enclosures or in COB panel support.
Single-sized modular units may be directly mounted inside MIXO ONE enclosures.

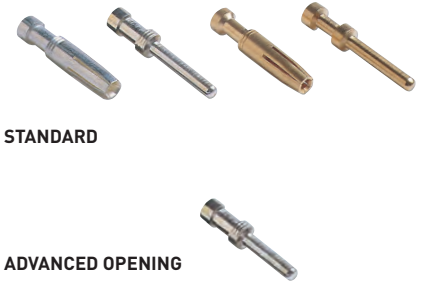
frames for modular units page: 316 - 317
MIXO ONE enclosures 369

- it is recommended to crimp the contacts with crimping tools homologated by ILME (please see the crimping tool section 16A contacts, CCF, CCM and CC...AN series) on pages 708 - 741

modular units, crimp connections



16A crimp contacts standard or for advanced opening silver and gold plated



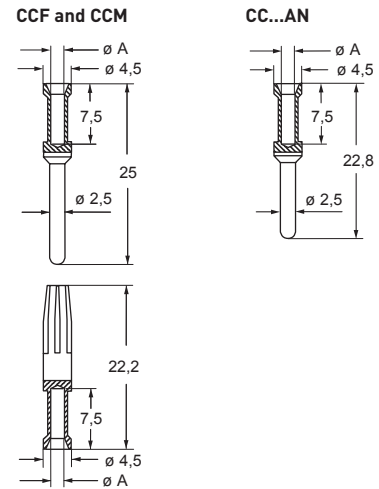
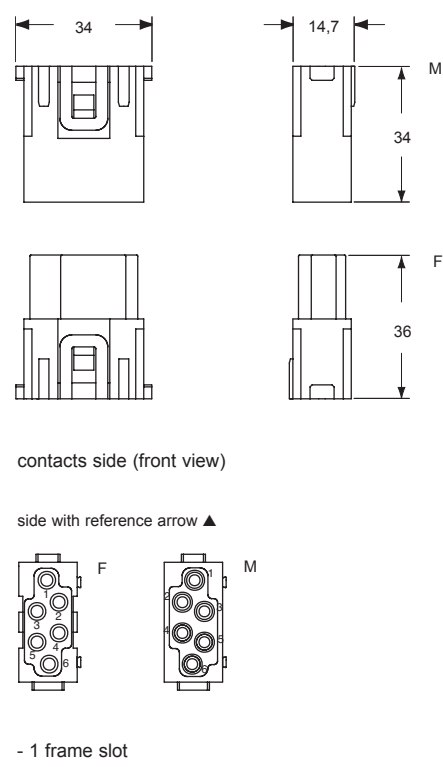
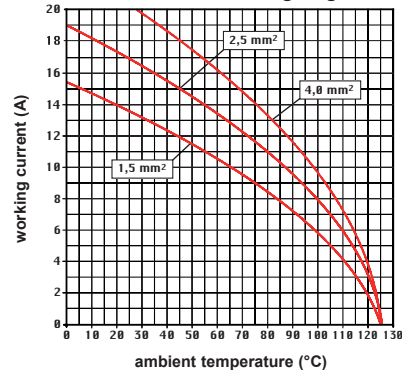
STANDARD

ADVANCED OPENING

description	part No.	part No.	part No.		
without contacts (to be ordered separately)					
female inserts for female contacts	CX 06 CF				
male inserts for male contacts	CX 06 CM				
16A female crimp contacts					
0,14-0,37 mm ² AWG 26-22 one groove		CCFA 0.3	CCFD 0.3	silver plated	
0,5 mm ² AWG 20 with no grooves		CCFA 0.5	CCFD 0.5		
0,75 mm ² AWG 18 one groove (back side)		CCFA 0.7	CCFD 0.7		
1 mm ² AWG 18 one groove		CCFA 1.0	CCFD 1.0		
1,5 mm ² AWG 16 two grooves		CCFA 1.5	CCFD 1.5		
2,5 mm ² AWG 14 three grooves		CCFA 2.5	CCFD 2.5		
3 mm ² AWG 12 one wide groove		CCFA 3.0	CCFD 3.0		
4 mm ² AWG 12 with no grooves		CCFA 4.0	CCFD 4.0		
16A male crimp contacts					gold plated+
0,14-0,37 mm ² AWG 26-22 one groove		CCMA 0.3	CCMD 0.3		
0,5 mm ² AWG 20 with no grooves		CCMA 0.5	CCMD 0.5		
0,75 mm ² AWG 18 one groove (back side)		CCMA 0.7	CCMD 0.7		
1 mm ² AWG 18 one groove		CCMA 1.0	CCMD 1.0		
1,5 mm ² AWG 16 two grooves		CCMA 1.5	CCMD 1.5		
2,5 mm ² AWG 14 three grooves		CCMA 2.5	CCMD 2.5		
3 mm ² AWG 12 one wide groove		CCMA 3.0	CCMD 3.0		
4 mm ² AWG 12 with no grooves		CCMA 4.0	CCMD 4.0		
16A male crimp contacts for advanced opening					
0,5 mm ² AWG 20 with no grooves		CC 0.5 AN	+ for basic or high thickness gold plating, please refer to page 675		
0,75 mm ² AWG 18 one groove (back side)		CC 0.7 AN			
1 mm ² AWG 18 one groove		CC 1.0 AN			
1,5 mm ² AWG 16 two grooves		CC 1.5 AN			
2,5 mm ² AWG 14 three grooves		CC 2.5 AN			

- characteristics according to EN 61984:
- 16A 500V 6kV 3**
- 16A 400/690V 6kV 2**
- certified
- rated voltage according to UL/CSA: 600V
- insulation resistance: ≥ 10 GΩ
- ambient temperature limit: -40 °C ... +125 °C
- made of self-extinguishing thermoplastic resin UL 94V-0
- mechanical life: ≥ 500 cycles
- contact resistance: ≤ 1 mΩ
- for max. current load see the connector inserts derating diagram below; for more information see page 28

CX 06 C, 6 poles connector inserts
Maximum current load derating diagram



CCF, CCM and CC...AN contacts		
conductor section (mm ²)	conductor slot ø A (mm)	conductor stripping length (mm)
0,14-0,37	0,9	7,5
0,5	1,1	7,5
0,75	1,3	7,5
1,0	1,45	7,5
1,5	1,8	7,5
2,5	2,2	7,5
3	2,55	7,5
4	2,85	7,5

CX 06P CF/CM 6 poles protected 16A - 830V

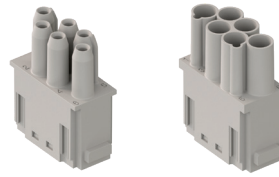
The modular inserts must be installed in suitable frames which are then mounted in traditional enclosures or in COB panel support.
Single-sized modular units may be directly mounted inside MIXO ONE enclosures.

frames for modular units page:
316 - 317

MIXO ONE enclosures 369

- we recommend the use of CRF / CRM coding pins together with relevant MIXO frame
- it is recommended to crimp the contacts with crimping tools homologated by ILME (please see the crimping tool section 16A contacts, CCF, CCM and CC...AN series) on pages 708 - 741

modular units, crimp connections



RATING 830V

16A crimp contacts standard or for advanced opening silver and gold plated



STANDARD



ADVANCED OPENING

description	part No.	part No.	part No.
without contacts (to be ordered separately)			
female inserts for female contacts	CX 06P CF		
male inserts for male contacts	CX 06P CM		
16A female contacts			
0,14-0,37 mm ² AWG 26-22 one groove		CCFA 0.3	CCFD 0.3
0,5 mm ² AWG 20 with no grooves		CCFA 0.5	CCFD 0.5
0,75 mm ² AWG 18 one groove (back side)		CCFA 0.7	CCFD 0.7
1 mm ² AWG 18 one groove		CCFA 1.0	CCFD 1.0
1,5 mm ² AWG 16 two grooves		CCFA 1.5	CCFD 1.5
2,5 mm ² AWG 14 three grooves		CCFA 2.5	CCFD 2.5
3 mm ² AWG 12 one wide groove		CCFA 3.0	CCFD 3.0
4 mm ² AWG 12 with no grooves		CCFA 4.0	CCFD 4.0
16A male contacts			
0,14-0,37 mm ² AWG 26-22 one groove		CCMA 0.3	CCMD 0.3
0,5 mm ² AWG 20 with no grooves		CCMA 0.5	CCMD 0.5
0,75 mm ² AWG 18 one groove (back side)		CCMA 0.7	CCMD 0.7
1 mm ² AWG 18 one groove		CCMA 1.0	CCMD 1.0
1,5 mm ² AWG 16 two grooves		CCMA 1.5	CCMD 1.5
2,5 mm ² AWG 14 three grooves		CCMA 2.5	CCMD 2.5
3 mm ² AWG 12 one wide groove		CCMA 3.0	CCMD 3.0
4 mm ² AWG 12 with no grooves		CCMA 4.0	CCMD 4.0
16A male crimp contacts for advanced opening			
0,5 mm ² AWG 20 with no grooves		CC 0.5 AN	+ for basic or high thickness gold plating, please refer to page 675
0,75 mm ² AWG 18 one groove (back side)		CC 0.7 AN	
1 mm ² AWG 18 one groove		CC 1.0 AN	
1,5 mm ² AWG 16 two grooves		CC 1.5 AN	
2,5 mm ² AWG 14 three grooves		CC 2.5 AN	

silver plated

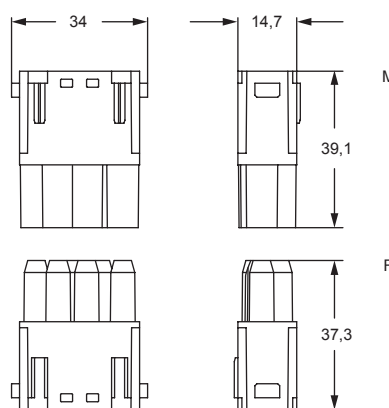
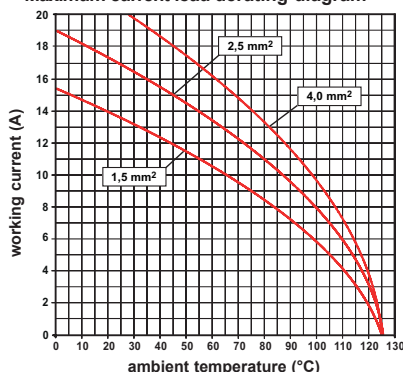
gold plated+

- characteristics according to EN 61984:

16A 830V 8kV 3

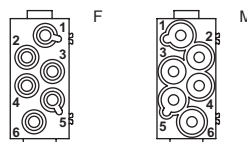
- certified
- rated voltage according to UL/CSA: 600V
- insulation resistance: $\geq 10 \text{ G}\Omega$
- ambient temperature limit: $-40 \text{ }^\circ\text{C} \dots +125 \text{ }^\circ\text{C}$
- made of self-extinguishing thermoplastic resin UL 94V-0
- mechanical life: ≥ 500 cycles
- contact resistance: $\leq 1 \text{ m}\Omega$
- for max. current load see the connector inserts derating diagram below; for more information see page 28

CX 06P C, 6 poles connector inserts Maximum current load derating diagram



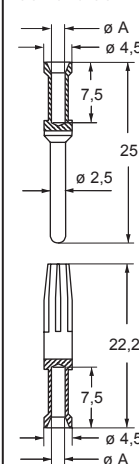
contacts side (front view)

side with reference arrow ▲

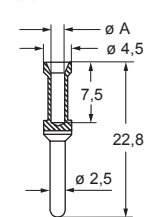


- 1 frame slot

CCF and CCM



CC...AN



CCF, CCM and CC..AN contacts

conductor section (mm ²)	conductor slot $\varnothing A$ (mm)	conductors stripping length (mm)
0,14-0,37	0,9	7,5
0,5	1,1	7,5
0,75	1,3	7,5
1,0	1,45	7,5
1,5	1,8	7,5
2,5	2,2	7,5
3	2,55	7,5
4	2,85	7,5

CX 08 CF/CM 8 poles 16A - 400V

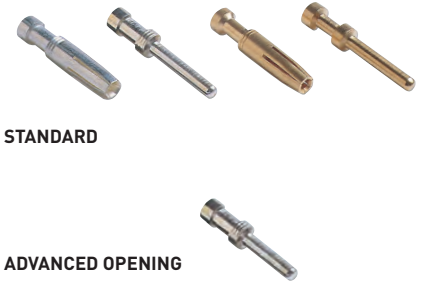
The modular inserts must be installed in suitable frames which are then mounted in traditional enclosures or in COB panel support.
Single-sized modular units may be directly mounted inside MIXO ONE enclosures.

frames for modular units page: 316 - 317
MIXO ONE enclosures 369

modular units, crimp connections



16A crimp contacts standard or for advanced opening silver and gold plated

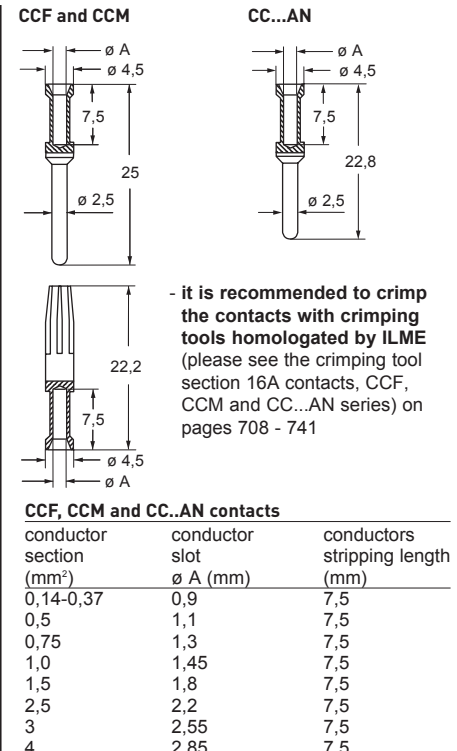
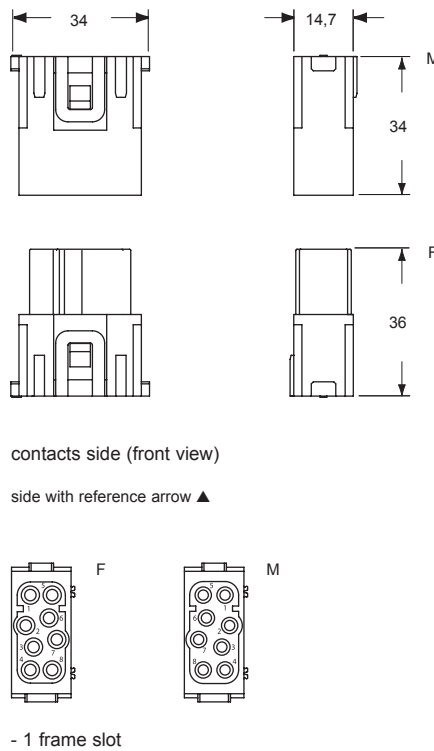
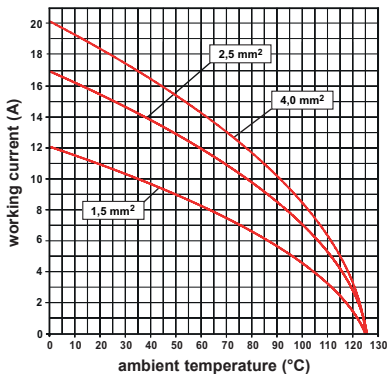


description	part No.	part No.	part No.
without contacts (to be ordered separately)			
female inserts for female contacts	CX 08 CF		
male inserts for male contacts	CX 08 CM		
16A female crimp contacts			
0,14-0,37 mm ² AWG 26-22 one groove		CCFA 0.3	CCFD 0.3
0,5 mm ² AWG 20 with no grooves		CCFA 0.5	CCFD 0.5
0,75 mm ² AWG 18 one groove (back side)		CCFA 0.7	CCFD 0.7
1 mm ² AWG 18 one groove		CCFA 1.0	CCFD 1.0
1,5 mm ² AWG 16 two grooves		CCFA 1.5	CCFD 1.5
2,5 mm ² AWG 14 three grooves		CCFA 2.5	CCFD 2.5
3 mm ² AWG 12 one wide groove		CCFA 3.0	CCFD 3.0
4 mm ² AWG 12 with no grooves		CCFA 4.0	CCFD 4.0
16A male crimp contacts			
0,14-0,37 mm ² AWG 26-22 one groove		CCMA 0.3	CCMD 0.3
0,5 mm ² AWG 20 with no grooves		CCMA 0.5	CCMD 0.5
0,75 mm ² AWG 18 one groove (back side)		CCMA 0.7	CCMD 0.7
1 mm ² AWG 18 one groove		CCMA 1.0	CCMD 1.0
1,5 mm ² AWG 16 two grooves		CCMA 1.5	CCMD 1.5
2,5 mm ² AWG 14 three grooves		CCMA 2.5	CCMD 2.5
3 mm ² AWG 12 one wide groove		CCMA 3.0	CCMD 3.0
4 mm ² AWG 12 with no grooves		CCMA 4.0	CCMD 4.0
16A male crimp contacts for advanced opening			
0,5 mm ² AWG 20 with no grooves		CC 0.5 AN	+ for basic or high thickness gold plating, please refer to page 675
0,75 mm ² AWG 18 one groove (back side)		CC 0.7 AN	
1 mm ² AWG 18 one groove		CC 1.0 AN	
1,5 mm ² AWG 16 two grooves		CC 1.5 AN	
2,5 mm ² AWG 14 three grooves		CC 2.5 AN	

- characteristics according to EN 61984:
- 16A 400V 6kV 3**
- 16A 400/690V 6kV 2**
- certified
- rated voltage according to UL/CSA: 600V
- insulation resistance: ≥ 10 GΩ
- ambient temperature limit: -40 °C ... +125 °C
- made of self-extinguishing thermoplastic resin UL 94V-0
- mechanical life: ≥ 500 cycles
- contact resistance: ≤ 1 mΩ
- for max. current load see the connector inserts derating diagram below; for more information see page 28

CX 08 C, 8 poles connector inserts

Maximum current load derating diagram



CX 20 CF/CM 20 poles 16A - 500V

The modular inserts must be installed in suitable frames, which are then mounted in traditional enclosures or in COB panel supports.

frames for modular units page:
316 - 317

- it is recommended to crimp the contacts with crimping tools homologated by ILME (please see the crimping tool section 16A contacts, CCF, CCM and CC...AN series) on pages 708 - 741

modular units, crimp connections



16A crimp contacts standard or for advanced opening silver and gold plated



STANDARD

ADVANCED OPENING

description	part No.	part No.	part No.
without contacts (to be ordered separately)			
female inserts for female contacts ¹⁾	CX 20 CF		
male inserts for male contacts ¹⁾	CX 20 CM		
16A female crimp contacts			
0,14-0,37 mm ² AWG 26-22 one groove	CCFA 0.3	CCFD 0.3	
0,5 mm ² AWG 20 with no grooves	CCFA 0.5	CCFD 0.5	
0,75 mm ² AWG 18 one groove (back side)	CCFA 0.7	CCFD 0.7	
1 mm ² AWG 18 one groove	CCFA 1.0	CCFD 1.0	
1,5 mm ² AWG 16 two grooves	CCFA 1.5	CCFD 1.5	
2,5 mm ² AWG 14 three grooves	CCFA 2.5	CCFD 2.5	
3 mm ² AWG 12 one wide groove	CCFA 3.0	CCFD 3.0	
4 mm ² AWG 12 with no grooves	CCFA 4.0	CCFD 4.0	
16A male crimp contacts			
0,14-0,37 mm ² AWG 26-22 one groove	CCMA 0.3	CCMD 0.3	
0,5 mm ² AWG 20 with no grooves	CCMA 0.5	CCMD 0.5	
0,75 mm ² AWG 18 one groove (back side)	CCMA 0.7	CCMD 0.7	
1 mm ² AWG 18 one groove	CCMA 1.0	CCMD 1.0	
1,5 mm ² AWG 16 two grooves	CCMA 1.5	CCMD 1.5	
2,5 mm ² AWG 14 three grooves	CCMA 2.5	CCMD 2.5	
3 mm ² AWG 12 one wide groove	CCMA 3.0	CCMD 3.0	
4 mm ² AWG 12 with no grooves	CCMA 4.0	CCMD 4.0	
16A male crimp contacts for advanced opening			
0,5 mm ² AWG 20 with no grooves	CC 0.5 AN		+ for basic or high thickness gold plating, please refer to page 675
0,75 mm ² AWG 18 one groove (back side)	CC 0.7 AN		
1 mm ² AWG 18 one groove	CC 1.0 AN		
1,5 mm ² AWG 16 two grooves	CC 1.5 AN		
2,5 mm ² AWG 14 three grooves	CC 2.5 AN		

¹⁾ on request, version with 3 fastened CX 20 CF/CM inserts with poles numbered from 1 – 60 references: **CX 60 CF, CX 60 CM**

- characteristics according to EN 61984:

16A 500V 6kV 3
16A 830V 8kV 2

- US (UL for USA and Canada),

- certified

- rated voltage according to UL/CSA: 600V

- insulation resistance: $\geq 10 \text{ G}\Omega$

- ambient temperature limit: -40 °C ... +125 °C

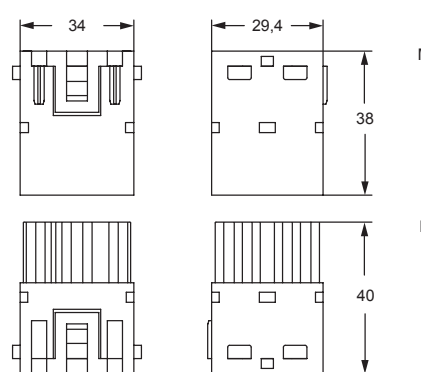
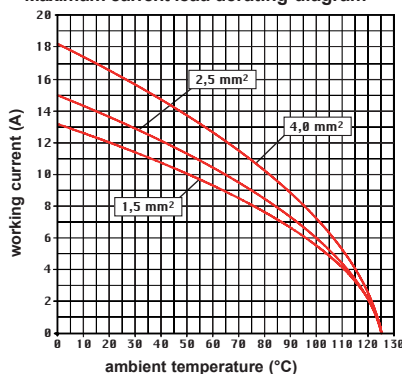
- made of self-extinguishing thermoplastic resin UL 94V-0

- mechanical life: ≥ 500 cycles

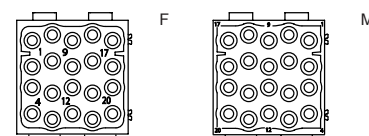
- contact resistance: $\leq 1 \text{ m}\Omega$

- for max. current load see the connector inserts derating diagram below; for more information see page 28

CX 20 C, 20 poles connector inserts
Maximum current load derating diagram

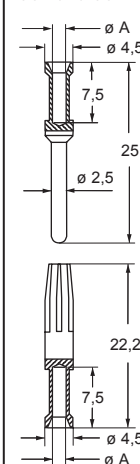


contacts side (front view)
side with reference arrow ▲

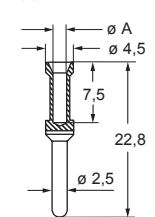


- 2 frame slots

CCF and CCM



CC...AN



CCF, CCM and CC...AN contacts

conductor section (mm ²)	conductor slot ø A (mm)	conductors stripping length (mm)
0,14-0,37	0,9	7,5
0,5	1,1	7,5
0,75	1,3	7,5
1,0	1,45	7,5
1,5	1,8	7,5
2,5	2,2	7,5
3	2,55	7,5
4	2,85	7,5

MIXO INSERTS

HT 2 poles single module 16A - 2500V

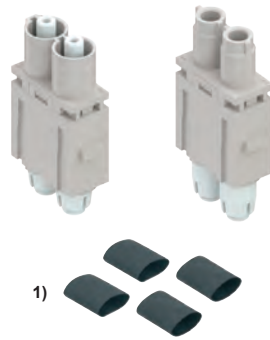
The modular inserts must be installed in suitable frames which are then mounted in traditional enclosures* or in COB panel support.
Single-sized modular units may be directly mounted inside MIXO ONE enclosures.

frames for modular units* page: 316 - 317
MIXO ONE enclosures 369

* enclosures: bulkhead mounting housings, high construction housings or high construction hoods

1) supplied with heat shrink insulating tubes for the rear of the contacts

high voltage modular units, crimp connections

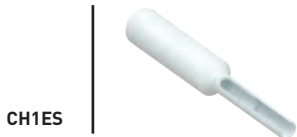


16A crimp contacts silver and gold plated

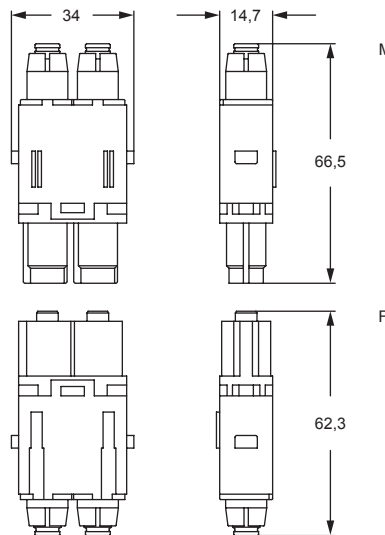


description	part No.	part No.	part No.
without contacts (to be ordered separately)			
high voltage female inserts for female contacts	CX 02 CHF		
high voltage male inserts for male contacts	CX 02 CHM		
contact holder removal tool	CH1ES		
16A female crimp contacts			
0,5 mm ² AWG 20 with no grooves		CCFA 0.5	CCFD 0.5
0,75 mm ² AWG 18 one groove (back side)		CCFA 0.7	CCFD 0.7
1 mm ² AWG 18 one groove		CCFA 1.0	CCFD 1.0
1,5 mm ² AWG 16 two grooves		CCFA 1.5	CCFD 1.5
2,5 mm ² AWG 14 three grooves		CCFA 2.5	CCFD 2.5
3 mm ² AWG 12 one wide groove		CCFA 3.0	CCFD 3.0
4 mm ² AWG 12 with no grooves		CCFA 4.0	CCFD 4.0
16A male crimp contacts			
0,5 mm ² AWG 20 with no grooves		CCMA 0.5	CCMD 0.5
0,75 mm ² AWG 18 one groove (back side)		CCMA 0.7	CCMD 0.7
1 mm ² AWG 18 one groove		CCMA 1.0	CCMD 1.0
1,5 mm ² AWG 16 two grooves		CCMA 1.5	CCMD 1.5
2,5 mm ² AWG 14 three grooves		CCMA 2.5	CCMD 2.5
3 mm ² AWG 12 one wide groove		CCMA 3.0	CCMD 3.0
4 mm ² AWG 12 with no grooves		CCMA 4.0	CCMD 4.0

- characteristics according to EN 61984 2): **16A 2500V 15kV 3**
- 2) used for guidance as applicable
- cURus, CSA, CQC, DNV-GL, BV, EAC pending
- insulation resistance: $\geq 10 \text{ G}\Omega$
- ambient temperature limit: $-40 \text{ }^\circ\text{C} \dots +125 \text{ }^\circ\text{C}$
- made of self-extinguishing thermoplastic resin UL 94V-0
- mechanical life: ≥ 500 cycles
- contact resistance: $\leq 1 \text{ m}\Omega$
- **it is recommended to crimp the contacts with crimping tools homologated by ILME** (please see the crimping tool section 16A contacts, CCF and CCM series) on pages 708 - 741
- contact holder removal tool: **CH1ES**

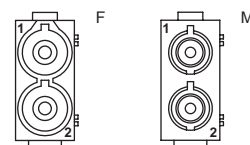


CH1ES

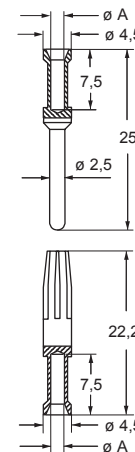


contacts side (front view)

side with reference arrow ▲



- 1 frame slot



CCF and CCM contacts

conductor section (mm ²)	conductor slot $\varnothing A$ (mm)	conductors stripping length (mm)
0,5	1,1	9,5
0,75	1,3	9,5
1,0	1,45	9,5
1,5	1,8	9,5
2,5	2,2	9,5
3	2,55	9,5
4	2,85	9,5

+ for basic or high thickness gold plating, please refer to page 675



Watch our online tutorial

HT 2 poles 16A - 2900/5000V

The modular inserts must be installed in suitable frames, which are then mounted in traditional enclosures* or in COB panel supports.

frames for modular units*

page: 316

* enclosures: bulkhead mounting housings, high construction housings or high construction hoods

1) supplied with heat shrink insulating tubes for the rear of the contacts

high voltage modular units, crimp connections contact holder removal tool



16A crimp contacts silver and gold plated



description	part No.	part No.	part No.
without contacts (to be ordered separately)			
high voltage female inserts for female contacts	CX 02 HF		
high voltage male inserts for male contacts	CX 02 HM		
contact holder removal tool	CHES		
16A female crimp contacts			
0,5 mm ² AWG 20 with no grooves		CCFA 0.5	CCFD 0.5
0,75 mm ² AWG 18 one groove (back side)		CCFA 0.7	CCFD 0.7
1 mm ² AWG 18 one groove		CCFA 1.0	CCFD 1.0
1,5 mm ² AWG 16 two grooves		CCFA 1.5	CCFD 1.5
2,5 mm ² AWG 14 three grooves		CCFA 2.5	CCFD 2.5
3 mm ² AWG 12 one wide groove		CCFA 3.0	CCFD 3.0
4 mm ² AWG 12 with no grooves		CCFA 4.0	CCFD 4.0
16A male crimp contacts			
0,5 mm ² AWG 20 with no grooves		CCMA 0.5	CCMD 0.5
0,75 mm ² AWG 18 one groove (back side)		CCMA 0.7	CCMD 0.7
1 mm ² AWG 18 one groove		CCMA 1.0	CCMD 1.0
1,5 mm ² AWG 16 two grooves		CCMA 1.5	CCMD 1.5
2,5 mm ² AWG 14 three grooves		CCMA 2.5	CCMD 2.5
3 mm ² AWG 12 one wide groove		CCMA 3.0	CCMD 3.0
4 mm ² AWG 12 with no grooves		CCMA 4.0	CCMD 4.0

MIXO INSERTS

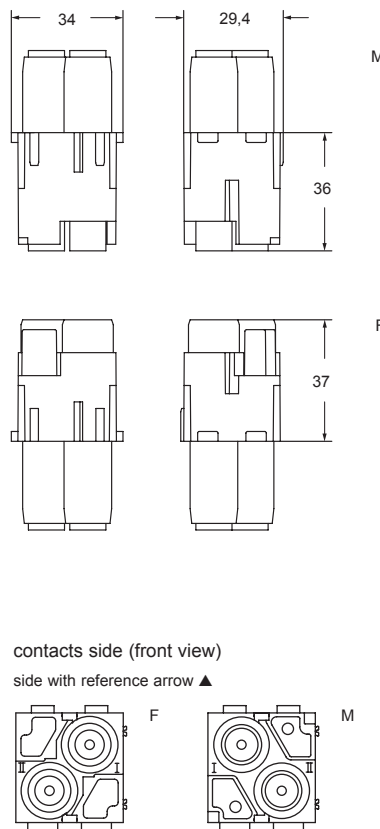
silver plated

gold plated+

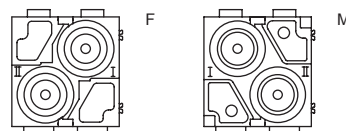
- characteristics according to EN 61984 2):
- 16A 2900/5000V 15kV 3**
- 2) used for guidance as applicable
- cURus, CSA, CQC, DNV-GL, BV, EAC pending
- insulation resistance: $\geq 10 \text{ G}\Omega$
- ambient temperature limit: $-40 \text{ }^\circ\text{C} \dots +125 \text{ }^\circ\text{C}$
- made of self-extinguishing thermoplastic resin UL 94V-0
- mechanical life: ≥ 500 cycles
- contact resistance: $\leq 1 \text{ m}\Omega$
- **it is recommended to crimp the contacts with crimping tools homologated by ILME** (please see the crimping tool section 16A contacts, CCF and CCM series) on pages 708 - 741
- contact holder removal tool: **CHES**
- maximum diameter of the cable insulation: 8 mm



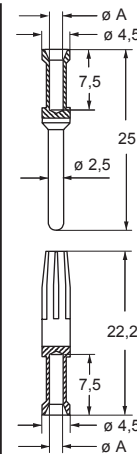
CHES



contacts side (front view)
side with reference arrow ▲



- 2 frame slots



CCF and CCM contacts

conductor section (mm ²)	conductor slot ø A (mm)	conductors stripping length (mm)
0,14-0,37	0,9	9,5
0,5	1,1	9,5
0,75	1,3	9,5
1,0	1,45	9,5
1,5	1,8	9,5
2,5	2,2	9,5
3	2,55	9,5
4	2,85	9,5

+ for basic or high thickness gold plating, please refer to page 675

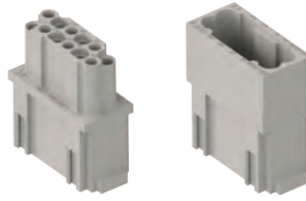
CX 12 DF/DM 12 poles 10A - 250V

The modular inserts must be installed in suitable frames which are then mounted in traditional enclosures* or in COB panel support.
Single-sized modular units may be directly mounted inside MIXO ONE enclosures.

frames for modular units*	page: 316 - 317
MIXO ONE enclosures	369

* enclosures: bulkhead mounting housings, high construction housings or high construction hoods

modular units,
crimp connections



RATING 250V

10A crimp contacts,
silver and gold plated



description	part No.	part No.	part No.
-------------	----------	----------	----------

without contacts (to be ordered separately)
female inserts for female contacts
male inserts for male contacts

CX 12 DF
CX 12 DM

10A female crimp contacts

0,14-0,37 mm ²	AWG 26-22	identification No. 1
0,5 mm ²	AWG 20	identification No. 2
0,75 mm ²	AWG 18	identification No. ②
1 mm ²	AWG 18	identification No. 3
1,5 mm ²	AWG 16	identification No. 4
2,5 mm ²	AWG 14	identification No. 5

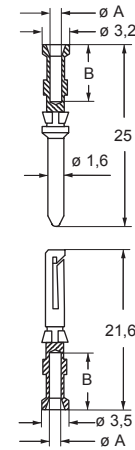
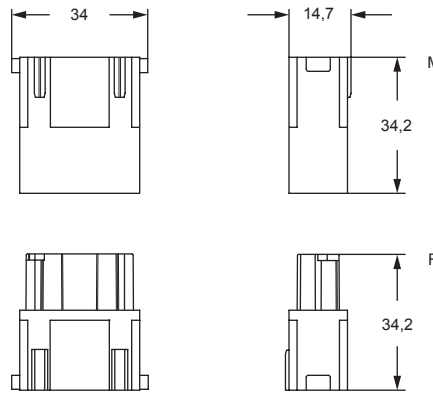
CDFA 0.3	silver plated	CDFD 0.3	gold plated+
CDFA 0.5		CDFD 0.5	
CDFA 0.7		CDFD 0.7	
CDFA 1.0		CDFD 1.0	
CDFA 1.5		CDFD 1.5	
CDFA 2.5		CDFD 2.5	

10A male crimp contacts

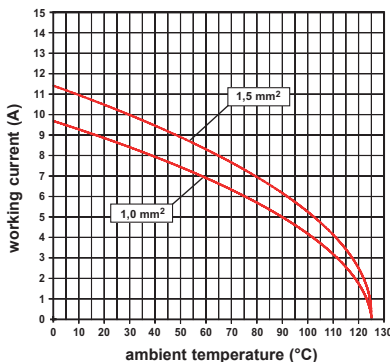
0,14-0,37 mm ²	AWG 26-22	identification No. 1
0,5 mm ²	AWG 20	identification No. 2
0,75 mm ²	AWG 18	identification No. ②
1 mm ²	AWG 18	identification No. 3
1,5 mm ²	AWG 16	identification No. 4
2,5 mm ²	AWG 14	identification No. 5

CDMA 0.3	silver plated	CDMD 0.3	gold plated+
CDMA 0.5		CDMD 0.5	
CDMA 0.7		CDMD 0.7	
CDMA 1.0		CDMD 1.0	
CDMA 1.5		CDMD 1.5	
CDMA 2.5		CDMD 2.5	

- characteristics according to EN 61984:
- 10A 250V 4kV 3**
- certified
- rated voltage according to UL/CSA: 600V
- insulation resistance: ≥ 10 GΩ
- ambient temperature limit: -40 °C ... +125 °C
- made of self-extinguishing thermoplastic resin UL 94V-0
- mechanical life: ≥ 500 cycles
- contact resistance: ≤ 3 mΩ
- PCBs interface, refer to article CIF 2.4 on page 670
- **it is recommended to crimp the contacts with crimping tools homologated by ILME** (please see the crimping tool section 10A contacts, CDF and CDM series) on pages 708 - 741
- for max. current load see the connector inserts derating diagram below; for more information see page 28

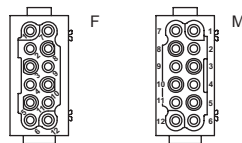


CX 12 D, 12 poles connector inserts
Maximum current load derating diagram



contacts side (front view)

side with reference arrow ▲



- 1 frame slot

CDF and CDM contacts

conductor section (mm ²)	conductor slot $\varnothing A$ (mm)	conductors stripping length B (mm)
0,14-0,37	0,9	8
0,5	1,1	8
0,75	1,3	8
1,0	1,45	8
1,5	1,8	8
2,5	2,2	6

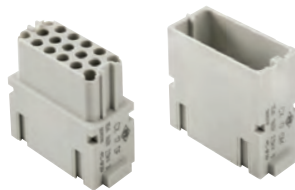
+ for basic or high thickness gold plating, please refer to page 674

CX 17 DF/DM 17 poles 10A - 160V

The modular inserts must be installed in suitable frames which are then mounted in traditional enclosures or in COB panel support.
Single-sized modular units may be directly mounted inside MIXO ONE enclosures.

frames for modular units page: 316 - 317
MIXO ONE enclosures 369

modular units,
crimp connections



10A crimp contacts,
silver and gold plated



description	part No.	part No.	part No.
-------------	----------	----------	----------

without contacts (to be ordered separately)
female inserts for female contacts
male inserts for male contacts

CX 17 DF
CX 17 DM

10A female crimp contacts

0,14-0,37 mm ²	AWG 26-22	identification No. 1
0,5 mm ²	AWG 20	identification No. 2
0,75 mm ²	AWG 18	identification No. ②
1 mm ²	AWG 18	identification No. 3
1,5 mm ²	AWG 16	identification No. 4
2,5 mm ²	AWG 14	identification No. 5

CDFA 0.3
CDFA 0.5
CDFA 0.7
CDFA 1.0
CDFA 1.5
CDFA 2.5

silver plated

CDFD 0.3
CDFD 0.5
CDFD 0.7
CDFD 1.0
CDFD 1.5
CDFD 2.5

gold plated+

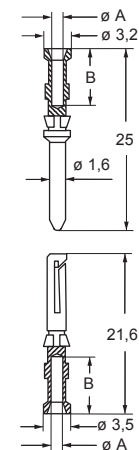
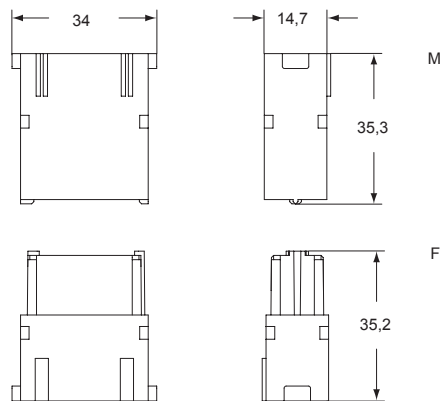
10A male crimp contacts

0,14-0,37 mm ²	AWG 26-22	identification No. 1
0,5 mm ²	AWG 20	identification No. 2
0,75 mm ²	AWG 18	identification No. ②
1 mm ²	AWG 18	identification No. 3
1,5 mm ²	AWG 16	identification No. 4
2,5 mm ²	AWG 14	identification No. 5

CDMA 0.3
CDMA 0.5
CDMA 0.7
CDMA 1.0
CDMA 1.5
CDMA 2.5

CDMD 0.3
CDMD 0.5
CDMD 0.7
CDMD 1.0
CDMD 1.5
CDMD 2.5

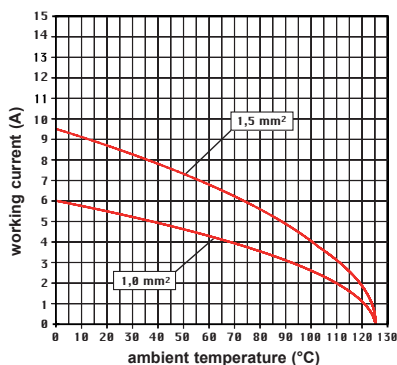
- characteristics according to EN 61984:
10A 160V 2,5kV 3
10A 250V 4kV 2
- us (UL for USA and Canada), cec, DNV-GL
- certified
- rated voltage according to UL/CSA: 250V
- insulation resistance: ≥ 10 GΩ
- ambient temperature limit: -40 °C ... +125 °C
- made of self-extinguishing thermoplastic resin UL 94V-0
- mechanical life: ≥ 500 cycles
- contact resistance: ≤ 3 mΩ
- **it is recommended to crimp the contacts with crimping tools homologated by ILME** (please see the crimping tool section 10A contacts, CDF and CDM series) on pages 708 - 741
- for max. current load see the connector inserts derating diagram below; for more information see page 28



CDF and CDM contacts

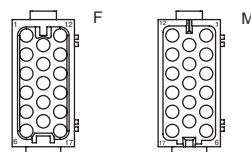
conductor section (mm ²)	conductor slot ϕA (mm)	conductors stripping length B (mm)
0,14-0,37	0,9	8
0,5	1,1	8
0,75	1,3	8
1,0	1,45	8
1,5	1,8	8
2,5	2,2	6

CX 17 D, 17 poles connector inserts
Maximum current load derating diagram



contacts side (front view)

side with reference arrow ▲



- 1 frame slot

+ for basic or high thickness gold plating, please refer to page 674

MIXO INSERTS

CX 42 DF/DM 42 poles 10A - 150V

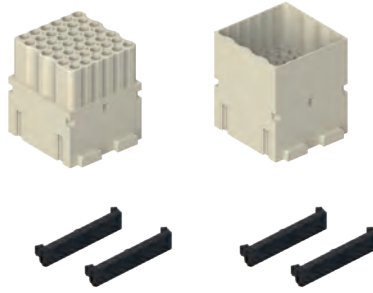
The modular inserts must be installed in suitable frames, which are then mounted in traditional enclosures* or in COB panel supports.

frames for modular units*

page: 316

* enclosures: bulkhead mounting housings, high construction housings or high construction hoods

modular units, crimp connections



10A crimp contacts, silver and gold plated



description	part No.	part No.	part No.
-------------	----------	----------	----------

without contacts (to be ordered separately), supplied with 2 dedicated black coloured 2-slot sized lock-in tab female inserts for female contacts
male inserts for male contacts

CX 42 DF
CX 42 DM

10A female crimp contacts

0,14-0,37 mm ²	AWG 26-22	identification No. 1
0,5 mm ²	AWG 20	identification No. 2
0,75 mm ²	AWG 18	identification No. ②
1 mm ²	AWG 18	identification No. 3
1,5 mm ²	AWG 16	identification No. 4
2,5 mm ²	AWG 14	identification No. 5

10A male crimp contacts

0,14-0,37 mm ²	AWG 26-22	identification No. 1
0,5 mm ²	AWG 20	identification No. 2
0,75 mm ²	AWG 18	identification No. ②
1 mm ²	AWG 18	identification No. 3
1,5 mm ²	AWG 16	identification No. 4
2,5 mm ²	AWG 14	identification No. 5

CDFA 0.3
CDFA 0.5
CDFA 0.7
CDFA 1.0
CDFA 1.5
CDFA 2.5

silver plated

CDFD 0.3
CDFD 0.5
CDFD 0.7
CDFD 1.0
CDFD 1.5
CDFD 2.5

gold plated⁺

CDMA 0.3
CDMA 0.5
CDMA 0.7
CDMA 1.0
CDMA 1.5
CDMA 2.5

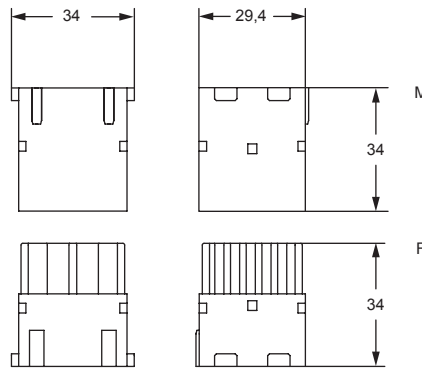
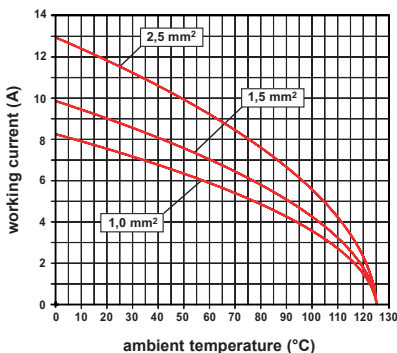
CDMD 0.3
CDMD 0.5
CDMD 0.7
CDMD 1.0
CDMD 1.5
CDMD 2.5

- characteristics according to EN 61984:

10A 150V 2,5kV 3

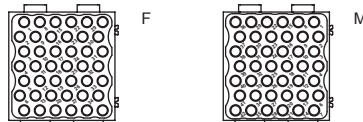
- cULus (UL for USA and Canada) certified, CSA, CQC, DNV-GL, BV, EAC pending
- rated voltage according to UL/CSA: 250V
- insulation resistance: $\geq 10 \text{ G}\Omega$
- ambient temperature limit: $-40 \text{ }^\circ\text{C} \dots +125 \text{ }^\circ\text{C}$
- made of self-extinguishing thermoplastic resin UL 94V-0
- mechanical life: ≥ 500 cycles
- contact resistance: $\leq 3 \text{ m}\Omega$
- supplied with dedicated black coloured 2-slot sized lock-in tab (2, one per each side).
- for spare lock-in tab **CX CFMD** see SPARE SPARTS catalogue
- **it is recommended to crimp the contacts with crimping tools homologated by ILME** (please see the crimping tool section 10A contacts, CDF and CDM series) on pages 708 - 741
- for max. current load see the connector inserts derating diagram below; for more information see page 28

CX 42 D, 42 poles connector inserts
Maximum current load derating diagram

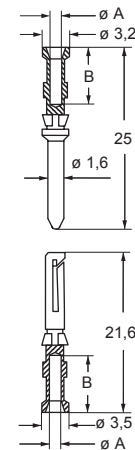


contacts side (front view)

rear view, side with reference arrow ▲



- 2 frame slots



CDF and CDM contacts

conductor section (mm ²)	conductor slot ø A (mm)	conductors stripping length B (mm)
0,14-0,37	0,9	8
0,5	1,1	8
0,75	1,3	8
1,0	1,45	8
1,5	1,8	8
2,5	2,2	6

⁺ for basic or high thickness gold plating, please refer to page 674

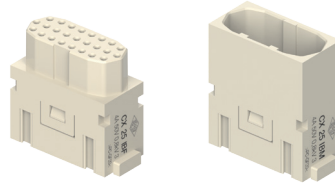
CX 25 IBF/IBM 25 poles 4A - 50V

The modular inserts must be installed in suitable frames which are then mounted in traditional enclosures or in COB panel support.
Single-sized modular units may be directly mounted inside MIXO ONE enclosures.

frames for modular units page: 316 - 317
MIXO ONE enclosures 369

- max insulating diameter 2,1 mm
- we recommend the use of CRF / CRM coding pins

modular units,
crimp connections



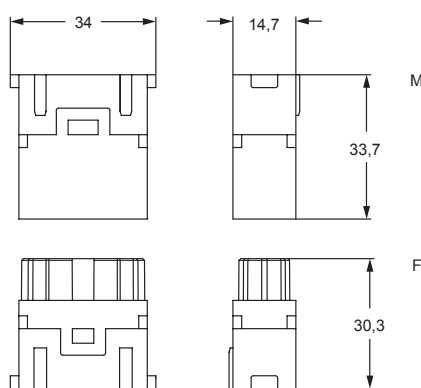
CI (4A) crimp contacts,
silver and gold plated



description	part No.	part No.	part No.
without contacts (to be ordered separately)			
female inserts for female contacts	CX 25 IBF		
male inserts for male contacts	CX 25 IBM		
CI (4A) female crimp contacts			
0,08-0,21 mm ² AWG 28-24		CIFA 0.2	CIFD 0.2
0,13-0,33 mm ² AWG 26-22		CIFA 0.3	CIFD 0.3
0,33-0,52 mm ² AWG 22-20		CIFA 0.5	CIFD 0.5
0,52-0,75 mm ² AWG 20-18		CIFA 0.7	CIFD 0.7
CI (4A) male crimp contacts			
0,08-0,21 mm ² AWG 28-24		CIMA 0.2	CIMD 0.2
0,13-0,33 mm ² AWG 26-22		CIMA 0.3	CIMD 0.3
0,33-0,52 mm ² AWG 22-20		CIMA 0.5	CIMD 0.5
0,52-0,75 mm ² AWG 20-18		CIMA 0.7	CIMD 0.7

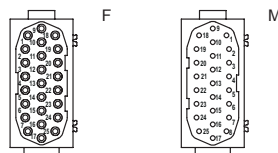
MIXO INSERTS

- characteristics according to EN 61984:
- 4A 50V 0,8kV 3**
- 4A 160V 2,5kV 2**
- DNV-GL **BUREAU VERITAS** certified
- rated voltage according to UL/CSA: 600V
- insulation resistance: ≥ 10 G Ω
- ambient temperature limit: -40 °C ... +125 °C
- made of self-extinguishing thermoplastic resin UL 94V-0
- mechanical life: ≥ 500 cycles
- contact resistance: ≤ 4 m Ω
- for crimp contacts CI series use, on page 716 - 719
- CIPZ D** crimping tool
- CITP D** turret head
- CIES** insertion / removal tool for contacts 0,2 - 0,5 mm²
- CIES B** insertion / removal tool for contacts 0,75 mm²
- for max. current load see the connector inserts derating diagram below; for more information see page 28

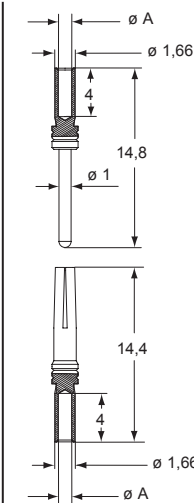


contacts side (front view)

side with reference arrow ▲



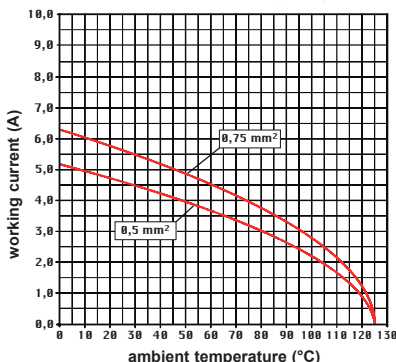
- 1 frame slot



CIF and CIM contacts

conductor section (mm ²)	conductor slot ø A (mm)	conductors stripping length (mm)
0,08-0,21	0,64	4
0,13-0,33	0,90	4
0,33-0,52	1,12	4
0,52-0,75	1,12	4

CX 25 IB, 25 poles connector inserts
Maximum current load derating diagram





MIXO INSERTS

Gigabit 8 poles 5A - 50V

The modular inserts must be installed in suitable frames which are then mounted in traditional enclosures* or in COB panel support.
Single-sized modular units may be directly mounted inside MIXO ONE enclosures.

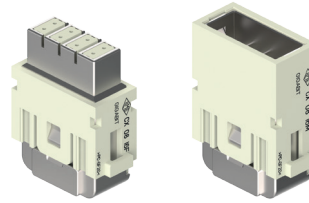
frames for modular units* page:
316 - 317

MIXO ONE enclosures 369

* enclosures: bulkhead mounting housings, high construction housings or high construction hoods

- we recommend the use of CRF / CRM coding pins together with relevant MIXO frame

modular units, crimp connections



cable clamp



description

part No.

part No.

without contacts (to be ordered separately)
female insert for female contacts
male insert for male contacts

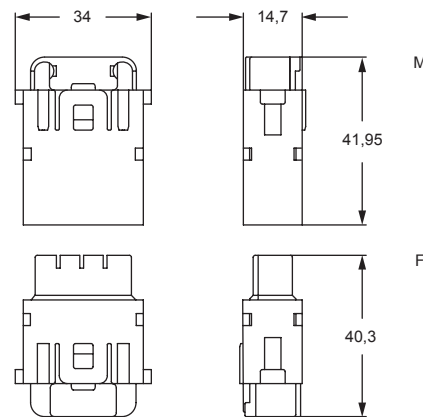
CX 08 I6F
CX 08 I6M

cable clamp for 5-7 mm cable diameter
cable clamp for 7-10 mm cable diameter
cable clamp for 10-12 mm cable diameter

CX 5/7 CA
CX 7/10 CA
CX 10/12 CA

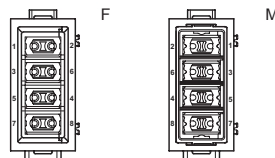
- characteristics according to EN 61984:
5A 50V 0,8kV 3
- (UL for USA and Canada) certified, CSA, CQC, DNV-GL, BV pending
- rated voltage according to UL/CSA: 50V
- insulation resistance: $\geq 10 \text{ G}\Omega$
- ambient temperature limit: $-40 \text{ }^\circ\text{C} \dots +85 \text{ }^\circ\text{C}$
- suitable for bus signals, in particular for Ethernet Cat. 6A (Gigabit)
- shield electrically separated from the PE of the housings
- made of self-extinguishing thermoplastic resin UL 94V-0
- mechanical life: ≥ 500 cycles
- contact resistance: $\leq 4 \text{ m}\Omega$
- for crimp contacts CI series use:
CIPZ D crimping tool
CITP D turret head

CX 08 I6F, CX 08 I6M



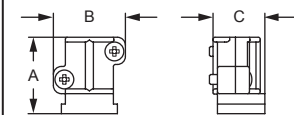
contacts side (front view)

side with reference arrow ▲



- 1 frame slot

CX 5/7 CA, CX 7/10 CA, CX 10/12 CA



part No.	A	B	C
CX 5/7 CA	19,1	18	12,95
CX 7/10 CA	19,1	18	12,95
CX 10/12 CA	19,1	20,8	12,95

MIXO DATA



Watch
our
online
tutorial

**CI (5A) crimp contacts
gold plated**



description

part No.

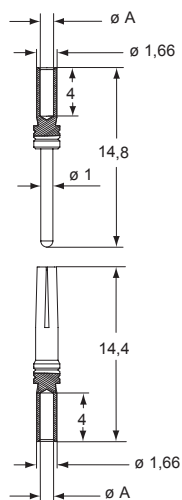
CI (5A) female crimp contacts
0,08-0,21 mm² AWG 28-24
0,13-0,33 mm² AWG 26-22
0,33-0,52 mm² AWG 22-20

CIFD 0.2
CIFD 0.3
CIFD 0.5

gold plated

CI (5A) male crimp contacts
0,08-0,21 mm² AWG 28-24
0,13-0,33 mm² AWG 26-22
0,33-0,52 mm² AWG 22-20

CIMD 0.2
CIMD 0.3
CIMD 0.5



CIF and CIM contacts

conductor section (mm ²)	conductor slot ø A (mm)	conductors stripping length (mm)
0,08-0,21	0,64	4
0,13-0,33	0,90	4
0,33-0,52	1,12	4

MIXO DATA

CX 02 BF/BM 2 seats for connector 1 pole + shield

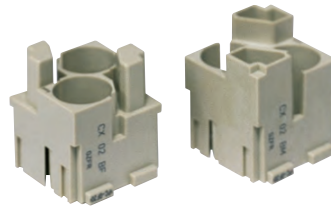
The modular inserts must be installed in suitable frames, which are then mounted in traditional enclosures* or in COB panel supports.

frames for modular units*

page:
316

* enclosures: bulkhead mounting housings, high construction housings or high construction hoods

modular units,
2-seat holder for shielded connectors



earthing adapter



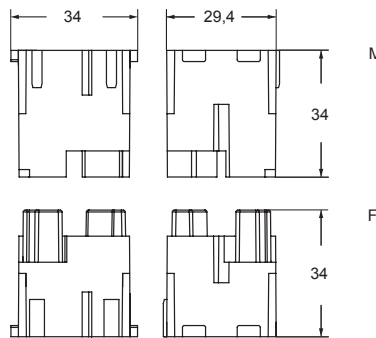
description	part No.	part No
-------------	----------	---------

2-seat holder for shielded connectors
female insert, two seats for BUS connectors
male insert, two seats for BUS connectors
earthing adapter (optional)

CX 02 BF
CX 02 BM

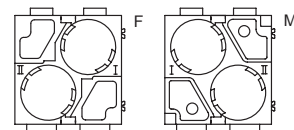
CR GND

- characteristics according to EN 61984:
50V 0,8kV 3
- certified
- rated voltage according to UL/CSA: 50V
- insulation resistance: $\geq 10 \text{ G}\Omega$
- ambient temperature limit: $-40 \text{ }^\circ\text{C} \dots +125 \text{ }^\circ\text{C}$
- made of self-extinguishing thermoplastic resin
UL 94V-0
- suitable to hold in place any combination of up to two shielded connectors **CX 01 BC** (page 289), **CX 01 B** (page 291), **CX 04 B** (page 291) or **CX 08 B** (page 293)
- both the female and the male inserts may accept a combination of up to two shielded connectors of any gender, as far as the correct specular assignment is set on the mating connector
- extraction tool for BUS shielded connectors from MIXO BUS insert part No. **CX BES** see page 703

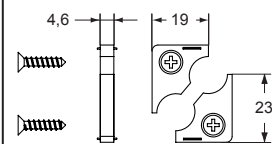


contacts side (front view)

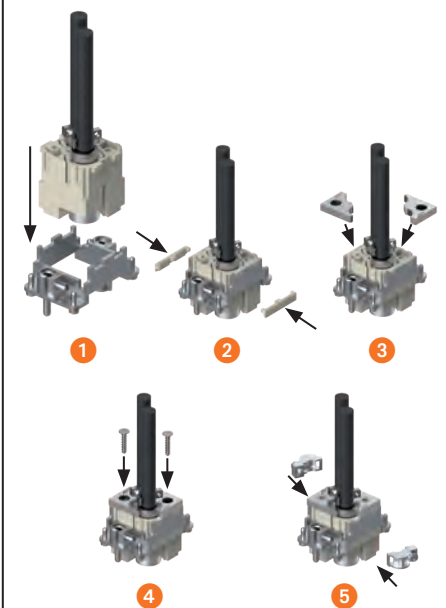
side with reference arrow ▲



- 2 frame slots



USE OF THE CR GND EARTHING ADAPTER



Note:
The shielded connectors have their shield insulated from the enclosure's earthing point.
If you wish to earth-connect the shield, install on the panel an anchorage for shielded cables **CR..ST** (see page 678) or the **CR GND** earthing adapter.



CX 01 BCF/BCM 1 pole + shield (each connector) 16A - 50V

- characteristics according to EN 61984:
CX 01 BC shielded connector
16A 50V 0,8kV 3
- certified
- rated voltage according to UL/CSA: 50V
- insulation resistance: $\geq 10 \text{ G}\Omega$
- ambient temperature limit: $-40 \text{ }^\circ\text{C} \dots +70 \text{ }^\circ\text{C}$
- contact resistance: $\leq 1 \text{ m}\Omega$
- mechanical life: ≥ 500 cycles
- for information on the crimping of contacts series CC (CX 01 BC shielded connector) and on the insertion/removal tools, see the section related to crimping tools (16A contacts, CCF and CCM series) on pages 708 - 741
- CX 01 BC shielded connector for **cable with a typical impedance of 50 Ω** (attenuation see below)
- suitable for **CX 02 B** (MIXO 2-seat holder) or **CX 1/2 BD** ("21.21" 1-seat adapter insert)
- female and male shielded connectors fit both in female and in male holder / adapter insert

shielded connectors



16A crimp contacts, silver and gold plated



description	part No.	part No.	part No.
-------------	----------	----------	----------

shielded BUS coaxial connectors, 1 pole + shield female insert, one contact seat 16A (CCF) + shield male insert, one contact seat 16A (CCM) + shield

CX 01 BCF
CX 01 BCM

16A female crimp contacts

Area	AWG	Profile
0,14-0,37 mm ²	AWG 26-22	one groove with no grooves
0,5 mm ²	AWG 20	one groove (back side)
0,75 mm ²	AWG 18	one groove
1 mm ²	AWG 18	two grooves
1,5 mm ²	AWG 16	three grooves
2,5 mm ²	AWG 14	one wide groove
3 mm ²	AWG 12	with no grooves
4 mm ²	AWG 12	with no grooves

16A male crimp contacts

Area	AWG	Profile
0,14-0,37 mm ²	AWG 26-22	one groove with no grooves
0,5 mm ²	AWG 20	one groove (back side)
0,75 mm ²	AWG 18	one groove
1 mm ²	AWG 18	two grooves
1,5 mm ²	AWG 16	three grooves
2,5 mm ²	AWG 14	one wide groove
3 mm ²	AWG 12	with no grooves
4 mm ²	AWG 12	with no grooves

CCFA 0.3
CCFA 0.5
CCFA 0.7
CCFA 1.0
CCFA 1.5
CCFA 2.5
CCFA 3.0
CCFA 4.0

silver plated

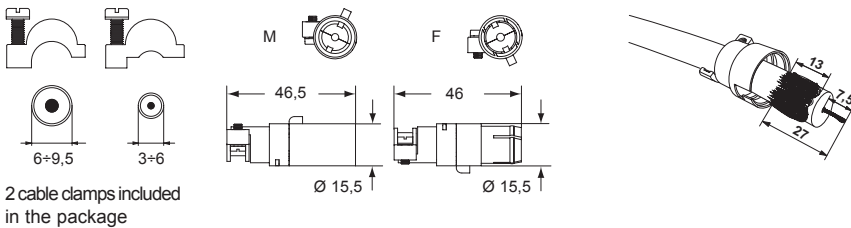
CCFD 0.3
CCFD 0.5
CCFD 0.7
CCFD 1.0
CCFD 1.5
CCFD 2.5
CCFD 3.0
CCFD 4.0

gold plated+

CCMA 0.3
CCMA 0.5
CCMA 0.7
CCMA 1.0
CCMA 1.5
CCMA 2.5
CCMA 3.0
CCMA 4.0

CCMD 0.3
CCMD 0.5
CCMD 0.7
CCMD 1.0
CCMD 1.5
CCMD 2.5
CCMD 3.0
CCMD 4.0

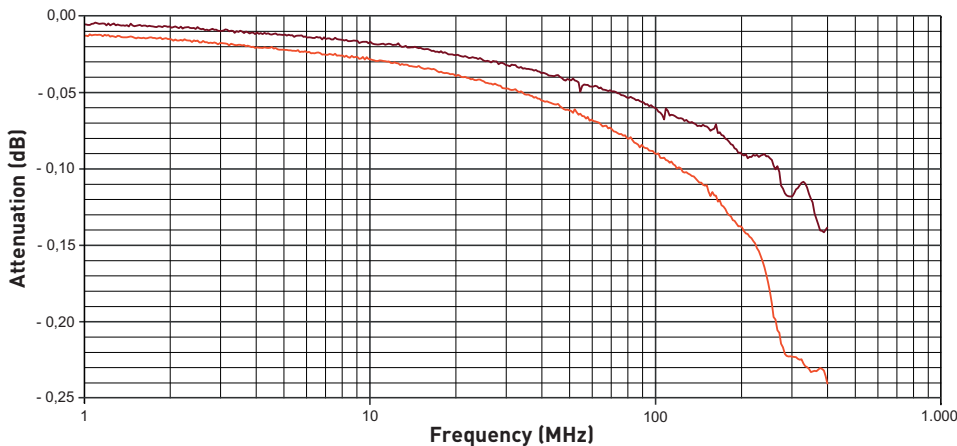
CX 01 BCF, CX 01 BCM



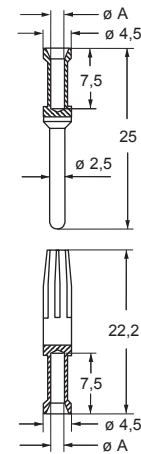
2 cable clamps included in the package

Test performed in accordance with IEC/EN 60512-25-2 (2002), 4.1.3.2 (coaxial cable only) and 4.2.2.2 (coaxial cable and connector).

Attenuation (insertion loss) 50 ohm coaxial connector (CX 01 BCF / BCM)



- RG 213/U cable and CX 01 BC connector (50 ohm)
- RG 213/U cable (50 ohm)



CCF and CCM contacts

conductor section (mm ²)	conductor slot ø A (mm)	conductors stripping length (mm)
0,14-0,37	0,9	7,5
0,5	1,1	7,5
0,75	1,3	7,5
1,0	1,45	7,5
1,5	1,8	7,5
2,5	2,2	7,5
3	2,55	7,5
4	2,85	7,5

+ for basic or high thickness gold plating, please refer to page 675

CX 02 BF/BM 2 seats for connector 1 or 4 poles + shield

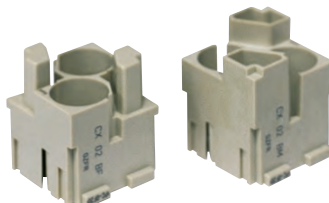
The modular inserts must be installed in suitable frames, which are then mounted in traditional enclosures* or in COB panel supports.

frames for modular units*

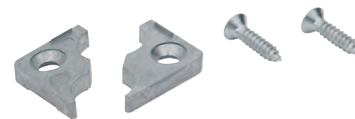
page:
316

* enclosures: bulkhead mounting housings, high construction housings or high construction hoods

modular units,
2-seat holder for shielded connectors



earthing adapter



description

part No.

part No

2-seat holder for shielded connectors
female insert, two seats for BUS connectors
male insert, two seats for BUS connectors
earthing adapter (optional)

CX 02 BF
CX 02 BM

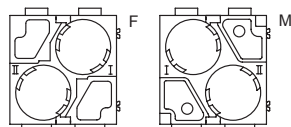
CR GND

- characteristics according to EN 61984:
50V 0,8kV 3
- certified
- rated voltage according to UL/CSA: 50V
- insulation resistance: $\geq 10 \text{ G}\Omega$
- ambient temperature limit: $-40 \text{ }^\circ\text{C} \dots +125 \text{ }^\circ\text{C}$
- made of self-extinguishing thermoplastic resin
UL 94V-0
- suitable to hold in place any combination of up to two shielded connectors **CX 01 BC** (page 289), **CX 01 B** (page 291), **CX 04 B** (page 291) or **CX 08 B** (page 293)
- both the female and the male inserts may accept a combination of up to two shielded connectors of any gender, as far as the correct specular assignment is set on the mating connector
- extraction tool for BUS shielded connectors from MIXO BUS insert part No. **CX BES** see page 703



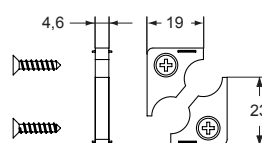
contacts side (front view)

side with reference arrow ▲

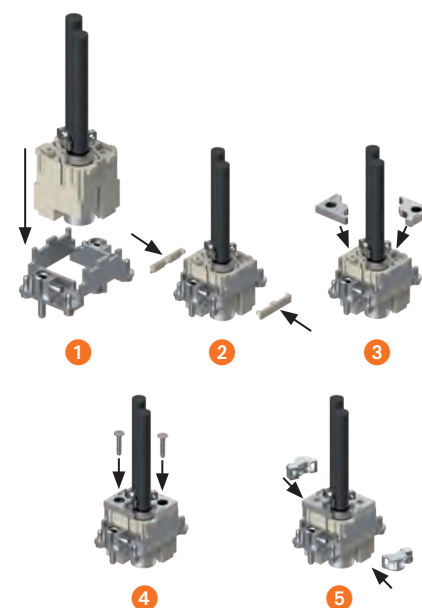


- 2 frame slots

Note:
The shielded connectors have their shield insulated from the enclosure's earthing point.
If you wish to earth-connect the shield, install on the panel an anchorage for shielded cables **CR..ST** (see page 678) or the **CR GND** earthing adapter.



USE OF THE CR GND EARTHING ADAPTER



CX 01 BF/BM - CX 04 BF/BM 1 or 4 poles + shield (each connector) 10A - 50V

- characteristics according to EN 61984: CX 04 B / CX 01 B shielded connector **10A 50V 0,8kV 3**
- certified
- rated voltage according to UL/CSA: 50V
- insulation resistance: $\geq 10 \text{ G}\Omega$
- ambient temperature limit: $-40 \text{ }^\circ\text{C} \dots +85 \text{ }^\circ\text{C}$
- mechanical life: ≥ 500 cycles
- contact resistance: shielded connector CX 04 B: $\leq 3 \text{ m}\Omega$
coaxial connector CX 01 B: $\leq 3 \text{ m}\Omega$
- for contact crimping instructions, refer to the crimping tool section (10A contacts, CDF and CDM series) on pages 708 - 741
- coaxial connector CX 01 B cables with a typical impedance of 75Ω (attenuation see below)
- CX 04 B multi axial connector for STP cables with 2 pairs and terminations compliant with EN 50173-1 Cat. 5 (100 MHz), compatible with 4-wire field bus protocols
- suitable for CX 02 B (MIXO 2-seat holder) or CX 1/2 BD ("21.21" 1-seat adapter insert)
- female and male shielded connectors fit both in female and in male holder / adapter insert

shielded connectors

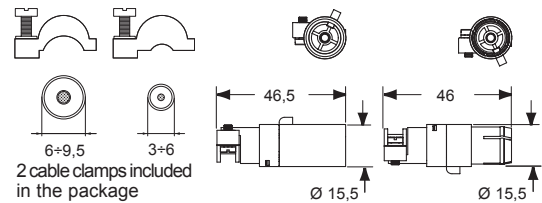


10A crimp contacts, silver and gold plated

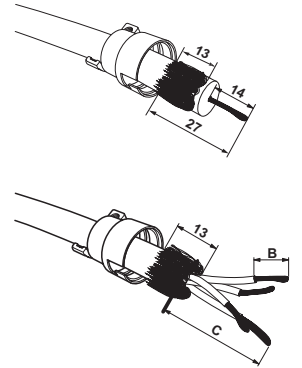
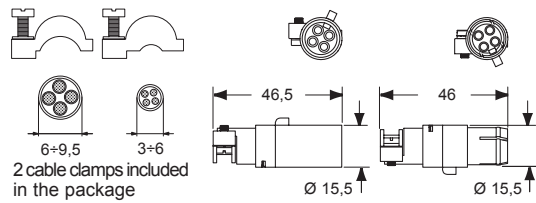


description	part No.	part No.	part No.
shielded BUS coaxial connectors, 1 pole + shield female insert, one contact seat 10A (CDF) + shield male insert, one contact seat 10A (CDM) + shield	CX 01 BF CX 01 BM		
shielded BUS multi axial connectors, 4 poles + shield female insert, four contact seats 10A (CDF) + shield male insert, four contact seats 10A (CDM) + shield	CX 04 BF CX 04 BM		
10A female crimp contacts			
0,14-0,37 mm ² AWG 26-22 identification No. 1		CDFA 0.3	CDFD 0.3
0,5 mm ² AWG 20 identification No. 2		CDFA 0.5	CDFD 0.5
0,75 mm ² AWG 18 identification No. ②		CDFA 0.7	CDFD 0.7
1 mm ² AWG 18 identification No. 3		CDFA 1.0	CDFD 1.0
1,5 mm ² AWG 16 identification No. 4		CDFA 1.5	CDFD 1.5
2,5 mm ² AWG 14 identification No. 5		CDFA 2.5	CDFD 2.5
10A male crimp contacts			
0,14-0,37 mm ² AWG 26-22 identification No. 1		CDMA 0.3	CDMD 0.3
0,5 mm ² AWG 20 identification No. 2		CDMA 0.5	CDMD 0.5
0,75 mm ² AWG 18 identification No. ②		CDMA 0.7	CDMD 0.7
1 mm ² AWG 18 identification No. 3		CDMA 1.0	CDMD 1.0
1,5 mm ² AWG 16 identification No. 4		CDMA 1.5	CDMD 1.5
2,5 mm ² AWG 14 identification No. 5		CDMA 2.5	CDMD 2.5

CX 01 BF, CX 01 BM

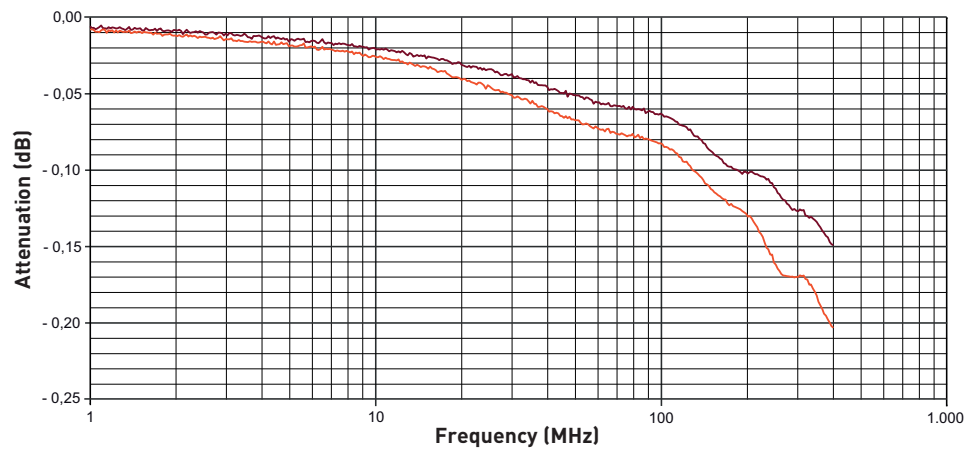


CX 04 BF, CX 04 BM



Test performed in accordance with IEC/EN 60512-25-2 (2002), 4.1.3.2 (coaxial cable only) and 4.2.2.2 (coaxial cable and connector).

Attenuation (insertion loss) 75 ohm coaxial connector (CX 01 BF / BM)



- RG 11 A/U cable and CX 01 B connector (75 ohm)
- RG 11 A/U cable (75 ohm)

cable clamp	C (mm)
3-6	20
6-9,5	25

CDF and CDM contacts		
conductor section	conductor slot	conductors stripping length
(mm ²)	$\varnothing A$ (mm)	B (mm)
0,14-0,37	0,9	8
0,5	1,1	8
0,75	1,3	8
1,0	1,45	8
1,5	1,8	8
2,5	2,2	6

+ for basic or high thickness gold plating, please refer to page 674

CX 02 BF/BM 2 seats for connector 8 poles + shield

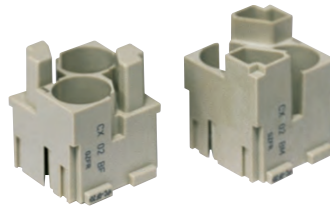
The modular inserts must be installed in suitable frames, which are then mounted in traditional enclosures* or in COB panel supports.

frames for modular units*

page:
317

* enclosures: bulkhead mounting housings, high construction housings or high construction hoods

modular units,
2-seat holder for shielded connectors



earthing adapter



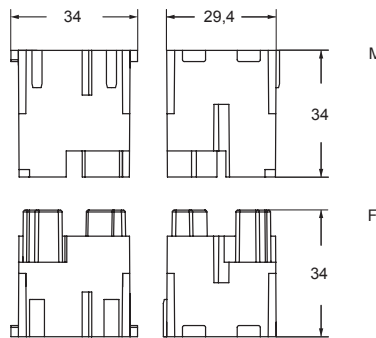
description	part No.	part No
-------------	----------	---------

2-seat holder for shielded connectors
female insert, two seats for BUS connectors
male insert, two seats for BUS connectors
earthing adapter (optional)

CX 02 BF
CX 02 BM

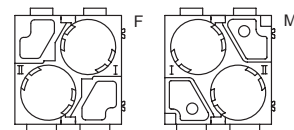
CR GND

- characteristics according to EN 61984:
50V 0,8kV 3
- certified
- rated voltage according to UL/CSA: 50V
- insulation resistance: $\geq 10 \text{ G}\Omega$
- ambient temperature limit: $-40 \text{ }^\circ\text{C} \dots +125 \text{ }^\circ\text{C}$
- made of self-extinguishing thermoplastic resin UL 94V-0
- suitable to hold in place any combination of up to two shielded connectors **CX 01 BC** (page 289), **CX 01 B** (page 291), **CX 04 B** (page 291) or **CX 08 B** (page 293)
- both the female and the male inserts may accept a combination of up to two shielded connectors of any gender, as far as the correct specular assignment is set on the mating connector
- extraction tool for BUS shielded connectors from MIXO BUS insert part No. **CX BES** see page 703

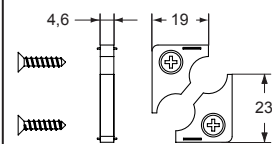


contacts side (front view)

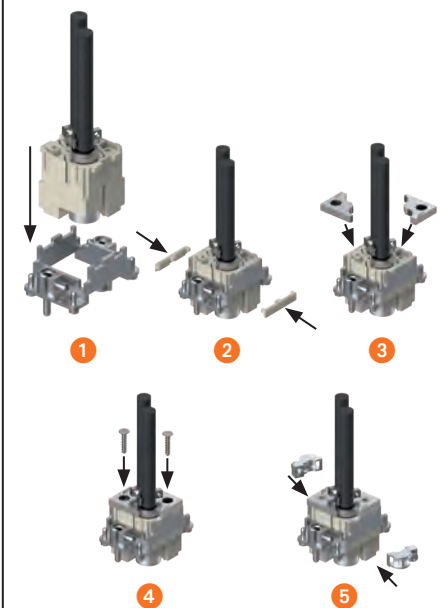
side with reference arrow ▲



- 2 frame slots



USE OF THE CR GND EARTHING ADAPTER



Note:
The shielded connectors have their shield insulated from the enclosure's earthing point.
If you wish to earth-connect the shield, install on the panel an anchorage for shielded cables **CR..ST** (see page 678) or the **CR GND** earthing adapter.

CX 08 BF/BM 8 poles + shield (each connector) 5A - 50V

shielded connectors



CI (5A) crimp contacts, silver and gold plated



description	part No.	part No.	part No.
-------------	----------	----------	----------

shielded BUS multi axial connectors, 8 poles + shield
 female insert, eight contact seats 5A (CIF) + shield
 male insert, eight contact seats 5A (CIM) + shield

CX 08 BF
CX 08 BM

CI (5A) female crimp contacts
 0,08-0,21 mm² AWG 28-24
 0,13-0,33 mm² AWG 26-22
 0,33-0,52 mm² AWG 22-20

CIFA 0.2
 CIFA 0.3
 CIFA 0.5

silver plated

CIFD 0.2
 CIFD 0.3
 CIFD 0.5

gold plated

CI (5A) male crimp contacts
 0,08-0,21 mm² AWG 28-24
 0,13-0,33 mm² AWG 26-22
 0,33-0,52 mm² AWG 22-20

CIMA 0.2
 CIMA 0.3
 CIMA 0.5

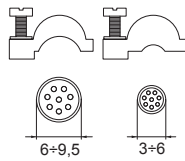
CIMD 0.2
 CIMD 0.3
 CIMD 0.5

- characteristics according to EN 61984:

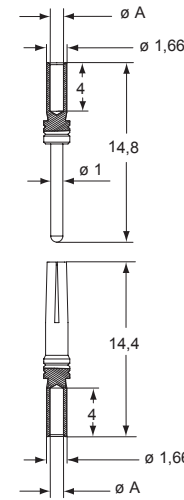
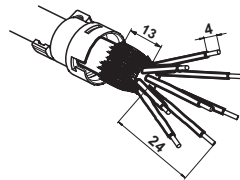
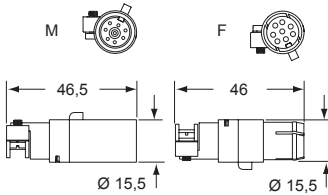
CX 08 B shielded connector

5A 50V 0,8kV 3

- certified
- rated voltage according to UL/CSA: 50V
- insulation resistance: ≥ 10 GΩ
- ambient temperature limit: -40 °C ... +85 °C
- mechanical life: ≥ 500 cycles
- contact resistance: ≤ 4 mΩ
- max. Ø of insulation for contacts CI series: 2,4 mm
- suitable for **CX 02 B** (MIXO 2-seat holder) or **CX 1/2 BD** ("21.21" 1-seat adapter insert)
- female and male shielded connectors fit both in female and in male holder / adapter insert
- for crimp 5A contacts CI series use:
CIPZ D crimping tool
CITP D turret head
CIES insertion / removal tool



2 cable clamps included in the package



CIF and CIM contacts

conductor section (mm ²)	conductor slot Ø A (mm)	conductors stripping length (mm)
0,08-0,21	0,64	4
0,13-0,33	0,90	4
0,33-0,52	1,12	4

CX 01 UF/UM for 1 USB connector

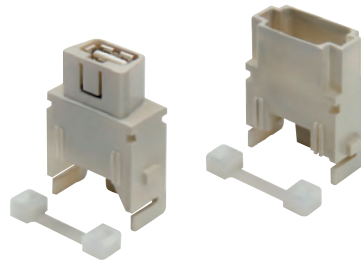
The modular inserts must be installed in suitable frames which are then mounted in traditional enclosures* or in COB panel support.
Single-sized modular units may be directly mounted inside MIXO ONE enclosures.

frames for modular units* page: 316 - 317

MIXO ONE enclosures 369

* enclosures: bulkhead mounting housings, high construction housings or high construction hoods

module adapter for USB male connector, USB 2.0 female-female coupler



patch cable USB



description

part No.

part No.

female insert with USB 2.0 female-female coupler ¹⁾
male insert without USB male connector (patch cable to be ordered separately) ¹⁾

CX 01 UF
CX 01 UM

patch cable USB-A / USB-A, 2 m ²⁾

CW 2 UAM

²⁾ 5 m on request

- characteristics according to EN 61984:

1A 50V 0,8kV 3

- ¹⁾ cULus (UL for USA and Canada),

- Bureau Veritas certified

- insulation resistance: $\geq 10 \text{ G}\Omega$

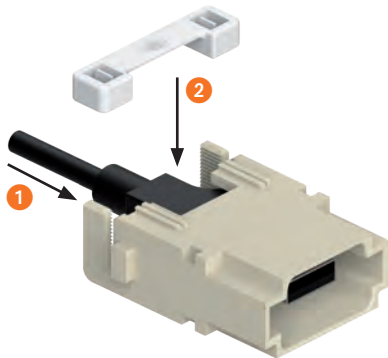
- contact resistance: $\leq 3 \text{ m}\Omega$

USB connector features:

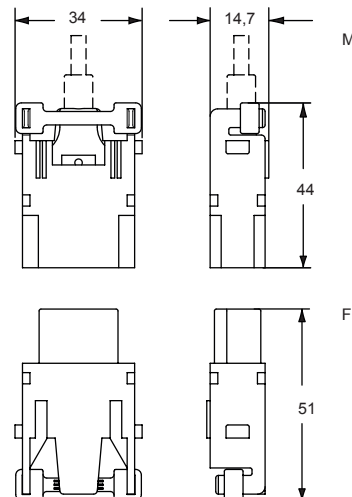
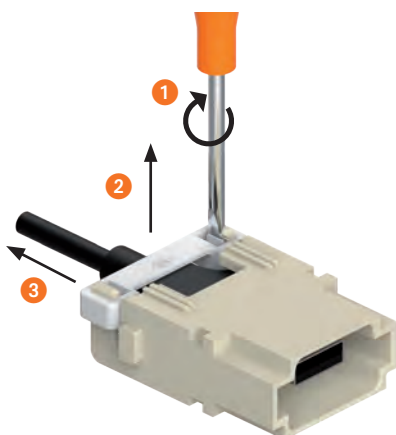
- USB-A / USB-A Hi-Speed - 2.0 insert

- temperature range: from $-25 \text{ }^\circ\text{C}$ to $+80 \text{ }^\circ\text{C}$

FIXING

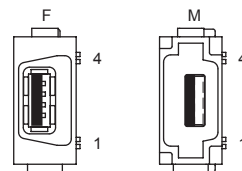


REOPENING

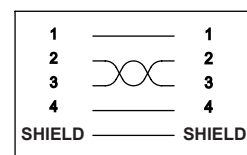
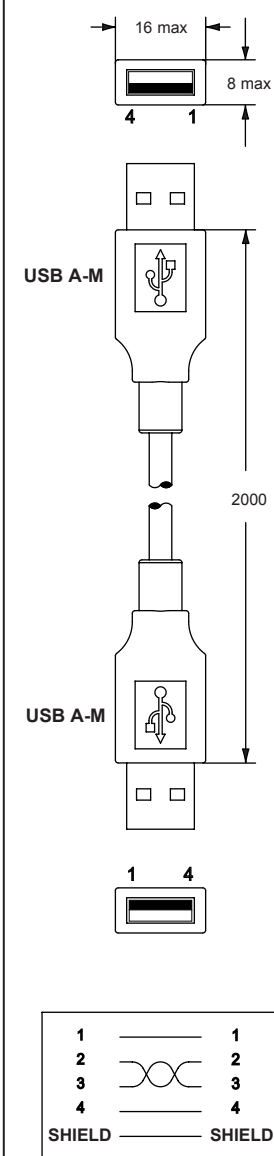


contacts side (front view)

side with reference arrow ▲



- 1 frame slot



MIXO DATA



MIXO DATA

CX 01 9VF/9VM for 9-pole crimp D-SUB connector

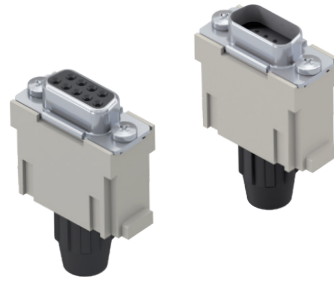
The modular inserts must be installed in suitable frames which are then mounted in traditional enclosures* or in COB panel support.
Single-sized modular units may be directly mounted inside MIXO ONE enclosures.

frames for modular units* page: 316 - 317

MIXO ONE enclosures 369

* enclosures:
housings or high construction hoods

module adapter for 1 D-SUB connector



CI (5 A) crimp contacts for D-SUB gold plated



description	part No.	part No
-------------	----------	---------

seat for 1 D-SUB crimp contacts connector and shield (included)

female insert with connector

CX 01 9VF
CX 01 9VM

male insert with connector

CI (5 A) female crimp contacts
0,08-0,21 mm² AWG 28-24
0,13-0,33 mm² AWG 26-22
0,33-0,52 mm² AWG 22-20
0,52-0,75 mm² AWG 20-18

CIFD 0.2
CIFD 0.3
CIFD 0.5
CIFD 0.7

gold plated

CI (5 A) male crimp contacts
0,08-0,21 mm² AWG 28-24
0,13-0,33 mm² AWG 26-22
0,33-0,52 mm² AWG 22-20
0,52-0,75 mm² AWG 20-18

CIMD 0.2
CIMD 0.3
CIMD 0.5
CIMD 0.7

- characteristics according to EN 61984:

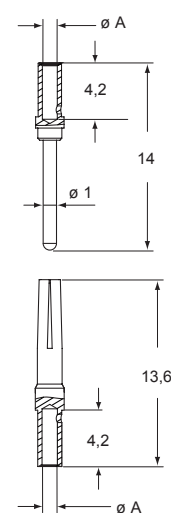
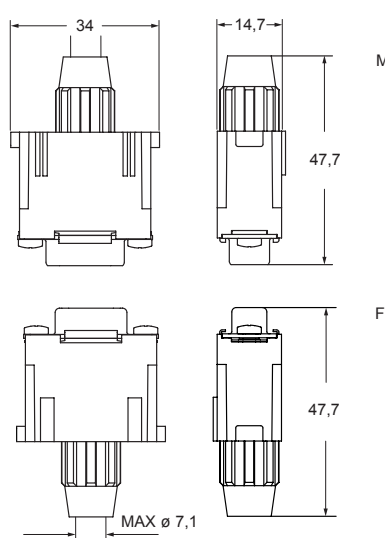
5 A 50 V 0,8 kV 3

- insulation resistance: $\geq 10 \text{ G}\Omega$
- ambient temperature limit: $-40 \text{ }^\circ\text{C} \dots +70 \text{ }^\circ\text{C}$
- mechanical life: ≥ 500 cycles
- contact resistance: $\leq 4 \text{ m}\Omega$
- for crimp 5 A contacts CI series use, on page 716:
CIPZ D crimping tool
CITP D turret head
CIVES insertion / removal tool
CIES B insertion / removal tool for size 0.7 contacts

Warnings:

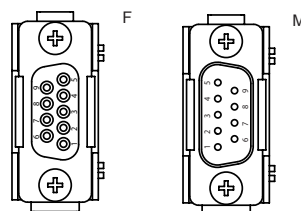
We recommend the use of coding pins
CRF CX / CRM CX (see pages 685 - 686)

CRF CX
CRM CX
coding pins



contacts side (front view)

side with reference arrow ▲

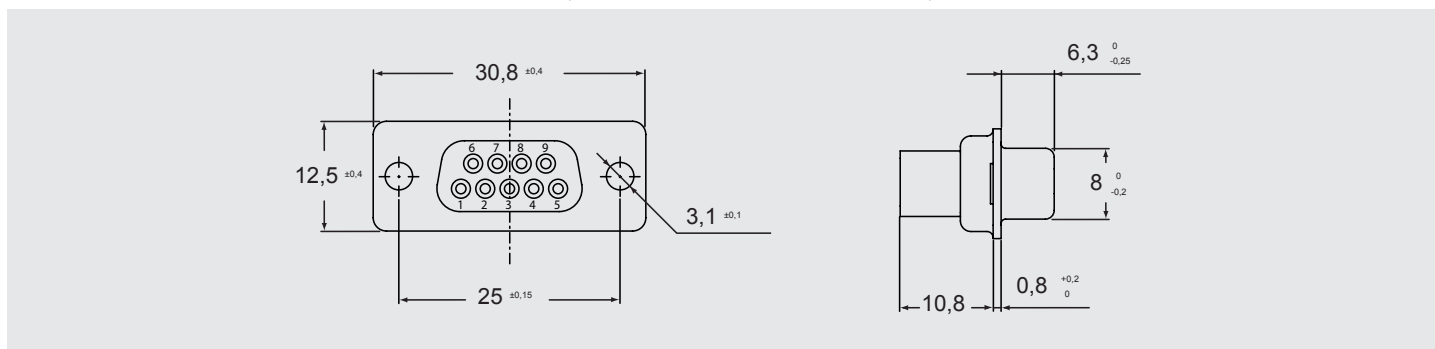


- 1 frame slot

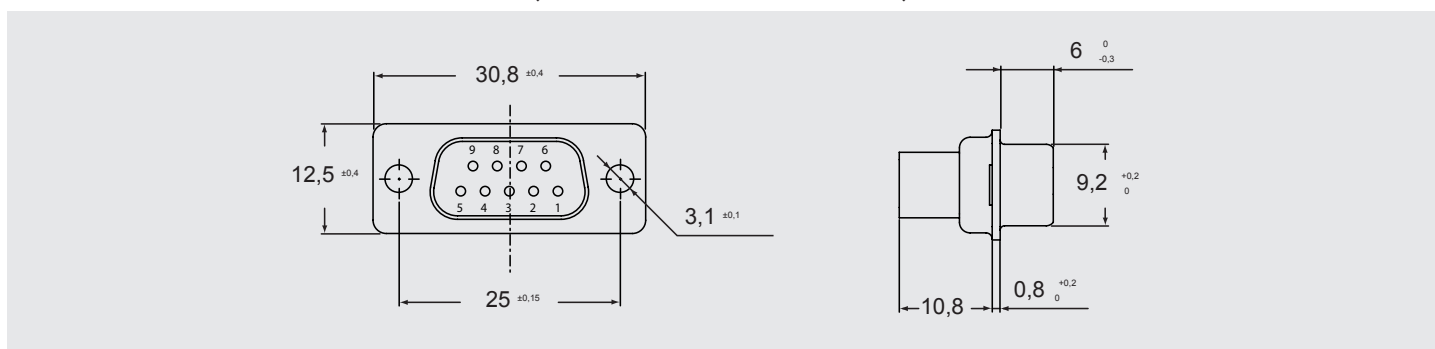
ALTERNATIVELY

	<p>- Seats for 1 D-SUB screw connectors (without shield):</p> <p>CX 01 9VFS (with female connectors) CX 01 9VMS (with male connectors)</p>
	<p>- Seat for 1 D-SUB connector (without connector and shield):</p> <p>CX 01 VM (for male connector) CX 01 VF (for female connector)</p> <p>Can also be used with 15-pole D-SUB Hi-Density connectors. For further information, please contact ILME S.p.A.</p>
	<p>- CR CX VS shield for CX 01 VM/VF inserts</p>

9-POLE FEMALE CRIMP D-SUB CONNECTOR (CAN BE USED WITH CX 01 VF)



9-POLE MALE CRIMP D-SUB CONNECTOR (CAN BE USED WITH CX 01 VM)



CX 01 9VTF 9-pole crimp D-SUB RS-485 BUS connector

The modular inserts must be installed in suitable frames which are then mounted in traditional enclosures* or in COB panel support.
Single-sized modular units may be directly mounted inside MIXO ONE enclosures.

frames for modular units* page: 316 - 317

MIXO ONE enclosures 369

* enclosures:
housings or high construction hoods

module adapter
for 1 D-SUB RS-485 connector



module adapter
for 1 D-SUB connector



description

part No.

part No

MIXO D-Sub 9-pole female module for RS-485 T-connection, with cable clamp accommodation for 2 cables

CX 01 9VTF

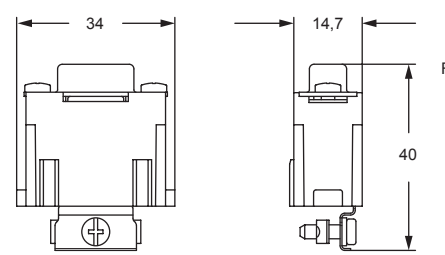
seat for 1 D-SUB crimp contacts connector and shield (included)
male insert with connector

CX 01 9VM

- characteristics according to EN 61984: **5A 50V 0,8kV 3**
- insulation resistance: $\geq 10 \text{ G}\Omega$
- ambient temperature limit: $-40 \text{ }^\circ\text{C} \dots +70 \text{ }^\circ\text{C}$
- mechanical life: ≥ 500 cycles
- contact resistance: $\leq 4 \text{ m}\Omega$
- "T" functionality with connection of two RS-485 bus cables (screw terminal)
- to be coupled with CX 01 9VM module
- for wires 0,14-0,5 mm² - 26-20 AWG
- cable screen max outer diameter 6 mm

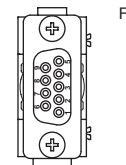
Warnings:
We recommend the use of coding pins
CRF CX / CRM CX (see pages 685 - 686)

CRF CX
CRM CX
coding pins

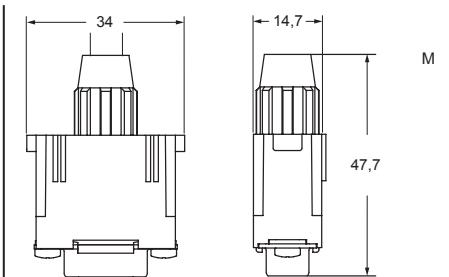


contacts side (front view)

side with reference arrow ▲

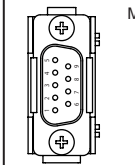


- 1 frame slot



contacts side (front view)

side with reference arrow ▲



- 1 frame slot



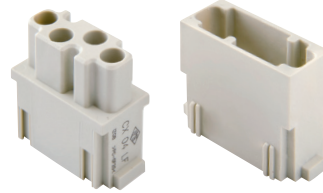
Watch
our
online
tutorial

for 4 POF or MOST^{® 3)} contacts (DIN 41626-3)

The modular inserts must be installed in suitable frames which are then mounted in traditional enclosures or in COB panel support.
Single-sized modular units may be directly mounted inside MIXO ONE enclosures.

frames for modular units page:
316 - 317
MIXO ONE enclosures 369

modular units, crimp connections



POF / MOST crimp contacts

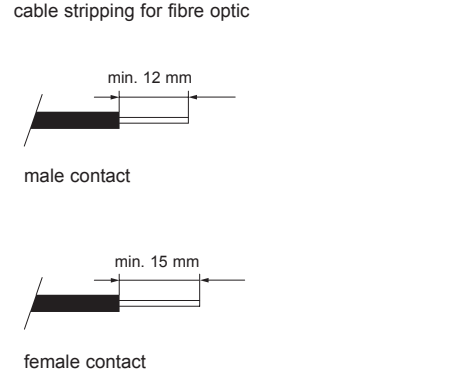
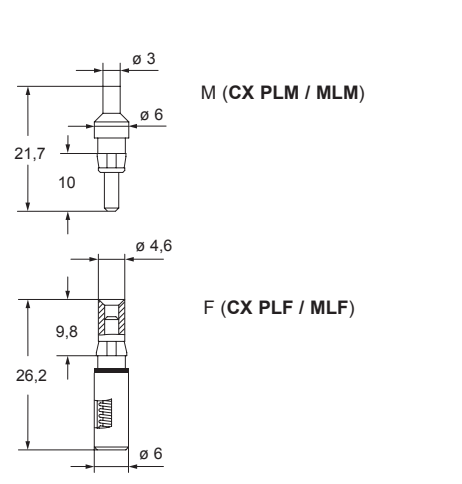
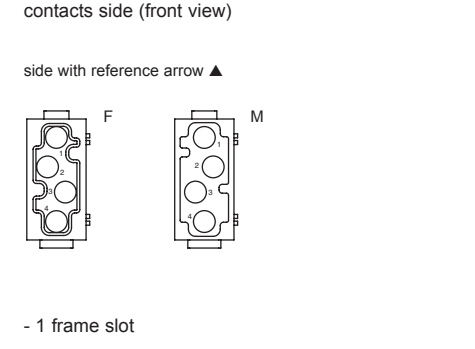
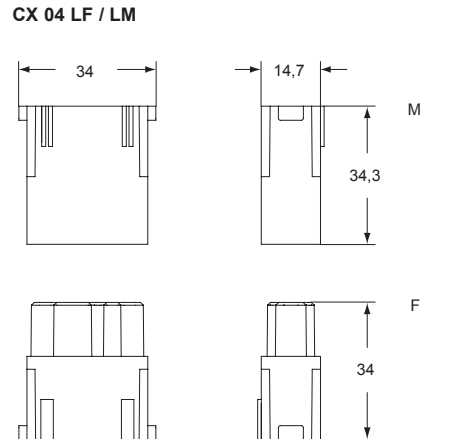
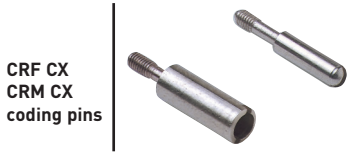


description	part No.	part No.
without contacts (to be ordered separately)		
female inserts for female contacts ¹⁾	CX 04 LF	
male inserts for male contacts ¹⁾	CX 04 LM	
female contacts POF ²⁾ 1,0 mm		CX PLF
male contacts POF ²⁾ 1,0 mm		CX PLM
female contacts MOST ^{® 3)} 1/1,5 mm		CX MLF
male contacts MOST ^{® 3)} 1/1,5 mm		CX MLM

²⁾ POF = POLYMER OPTICAL FIBRE
³⁾ MOST[®] = MEDIA ORIENTED SYSTEM TRANSPORT
MOST[®] is a registered trade mark of Microchip Technology Inc.

- (UL for USA and Canada), certified ¹⁾
- insulation resistance: ≥ 1 GΩ
- ambient temperature limit: -40 °C ... +85 °C
- inserts made of self-extinguishing thermoplastic resin UL 94V-0
- mechanical life: ≥ 500 cycles
- contact resistance: ≤ 30 mΩ
- max external diameter: 2,2 mm (POF)
2,3 mm (MOST)
- polymer fibre diameter: 1,0 mm (POF)
1/1,5 mm (MOST)
- attenuation: < 2.5 dB
- to crimp contacts CX PLF / PLM and CX MLF / MLM please use tool CLPZ R (see the crimping tool section on page 730)

We recommend to use CLASS enclosures with two levers or V-TYPE enclosures (with one or two levers) that provides a higher coupling depth due to the higher locking force they produce. We further suggest the use of coding pins CRF CX / CRM CX (see pages 685 - 686).



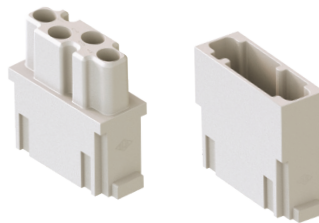
MIXO DATA

for 4 coaxial contacts DIN 41626-T2

The modular inserts must be installed in suitable frames which are then mounted in traditional enclosures or in COB panel support.
Single-sized modular units may be directly mounted inside MIXO ONE enclosures.

frames for modular units page: 316 - 317
MIXO ONE enclosures 369

modular units, crimp connections



crimp coaxial contacts



description

part No.

part No.

without contacts (to be ordered separately)
female inserts for female contacts
male inserts for male contacts

CX 04 RF
CX 04 RM

female coaxial contacts 50Ω
male coaxial contacts 50Ω

CX 50 RF
CX 50 RM

female coaxial contacts 75Ω
male coaxial contacts 75Ω

CX 75 RF
CX 75 RM

- characteristics according to EN 61984:

1,5A 50V 0,8kV 3

- (UL for USA and Canada), certified

- insulation resistance: $\geq 5 \text{ G}\Omega$

- temperature range: $-40 \text{ }^\circ\text{C} \dots +125 \text{ }^\circ\text{C}$

- inserts are made of self-extinguishing thermoplastic resin UL 94V-0

- mechanical life: ≥ 500 cycles

- in accordance with standard DIN 41626-T2

- finishing:

contact surfaces, body, back end and ferrule gold plated

- impedance: $50 \text{ }\Omega$

- frequency: DC to 6 GHz

- return loss: $\geq 21 \text{ dB}$, DC to 2 GHz
 $\geq 19 \text{ dB}$, 2 to 6 GHz

- insertion loss: $\leq 0,1 \times \sqrt{f(\text{GHz})} \text{ dB}$

- center contact resistance: $\leq 10 \text{ m}\Omega$

- outer contact resistance: $\leq 3 \text{ m}\Omega$

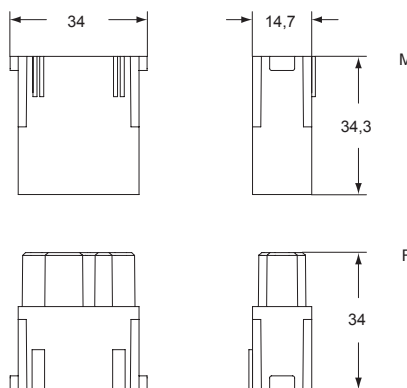
- test voltage: 750V rms

- working voltage: 250V rms

- RF-leakage: $\geq 80 \text{ dB}$ up to 0,5 GHz
 $\geq 65 \text{ dB}$ up to 1,5 GHz

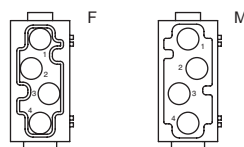
- to crimp contacts CX 50 RM/RF, CX 75 RM/RF use tool COPZ R (see the crimping tool section on page 734)

CX 04 RF / RM

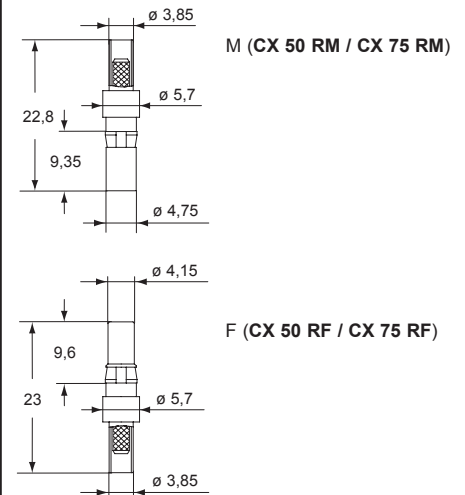


contacts side (front view)

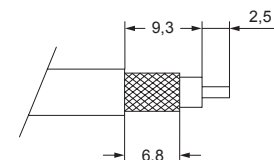
side with reference arrow ▲



- 1 frame slot



conductor stripping



Warnings:

We recommend the use of coding pins
CRF CX / CRM CX (see pages 685 - 686)

CRF CX
CRM CX
coding pins



coaxial contacts	for cables	ø external	part No.
50Ω	RG 316/U	2,49 $\pm 0,1$	CX 50 RF
	RG 174/U	2,79 $\pm 0,127$	CX 50 RM
	RG 188 A/U	2,79 max	
75Ω	RG 179 B/U	2,54 $\pm 0,127$	CX 75 RF
	RG 187 A/U	2,79 max	CX 75 RM
	TZC 75 101	2,79 max	

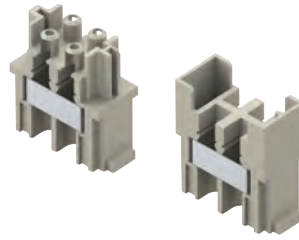
4 seats for fibre optic SC contacts

The modular inserts must be installed in suitable frames which are then mounted in traditional enclosures or in COB panel support.
Single-sized modular units may be directly mounted inside MIXO ONE enclosures.

frames for modular units	page: 316 - 317
MIXO ONE enclosures	369

WARNING:
inserts can be used on high enclosures or bulkhead housings only.

module adapter for SC connectors



crimp FO contacts

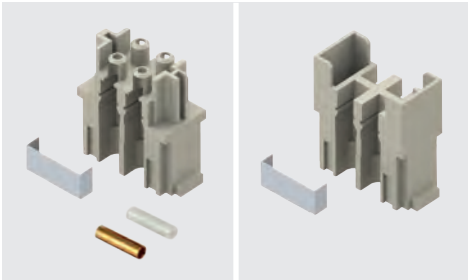


description	part No.	part No.
module insert with seats for 4 SC contacts (metal fixing plate included) female insert, with ceramic sleeve female insert, with metallic sleeve male insert	CX 04 SCF CX 04 SCF-H CX 04 SCM	CL 125 SC CL POF SC
SC contact for GI ¹⁾ FIBRE 50/125 µm or 62.5/125 µm SC contact for Ø POF 1 mm		

¹⁾ GI = Graded Index

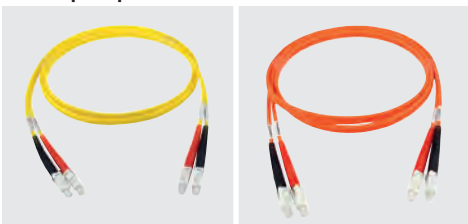
- (UL for USA and Canada), certified
- insulation resistance: ≥ 10 GΩ
- temperature range: from -40 °C to +85 °C
- made of self-extinguishing thermoplastic resin UL 94V-0
- mechanical life: ≥ 500 cycles
- adapter insert fitted with metal plate and sleeve (female only) fixing

CX 04 SC



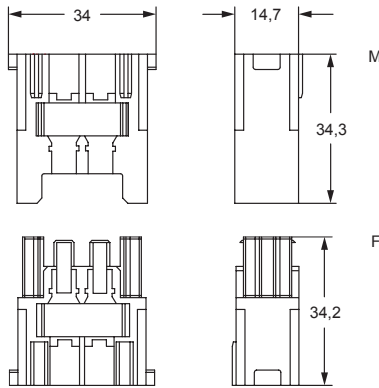
- adapter insert designed to be used with SC contacts
- SC contact for SI ²⁾ FIBRE (HCS_s) 200/230 µm:
CL 230 SC (on request)
- ²⁾ SI = Step Index
- base equipment for SC contact GI FIBRE:
CLKZ 125 SC
If this application is required, please contact ILME S.p.A.
- supplementary set for POF:
CLKZ POF
(to be ordered with CLKZ 125 SC)
If this application is required, please contact ILME S.p.A.

SC duplex patch cord



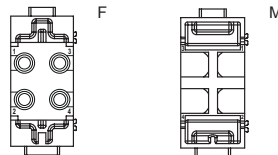
CW SC from page 240

CX 04 SCF, CX 04 SCF-H, CX 04 SCM



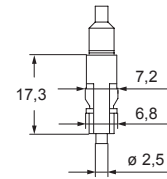
contacts side (front view)

side with reference arrow ▲

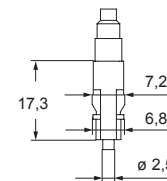


- 1 frame slot

CL 125 SC



CL POF SC




for 1 RJ45 Cat. 6 Class E_A

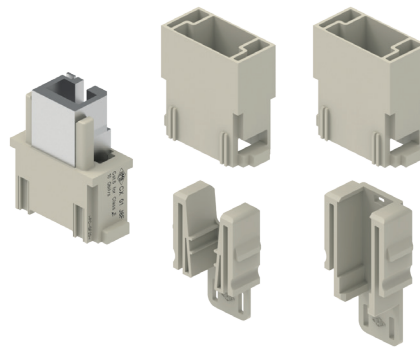
The modular inserts must be installed in suitable frames, which are then mounted in traditional enclosures or in COB panel supports.

frames for modular units page:
316 - 317

MIXO ONE enclosures 369

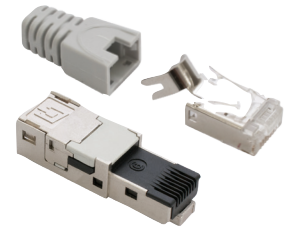
- characteristics according to EN 61984:
- **1A 50V 0,8kV 3**
- certified by UL for USA and Canada),  **BUREAU VERITAS** certified
- rated voltage according to UL/CSA: 50V
- insulation resistance: ≥ 10 GΩ
- made of self-extinguishing thermoplastic resin UL 94V-0
- mechanical life: ≥ 500 cycles
- contact resistance: ≤ 3 mΩ
- temperature range: from -40 °C to +85 °C
- we recommend to fix the cable with cable tie
- for contact crimping instructions, please see the crimping tool section on page 736 and 737

module adapters for RJ45 male connector, female insert with RJ45 female-female coupler



RJ45 male connectors, crimp and IDC termination

 Watch our CX 8 J6M online tutorial



 Watch our CX 8 J6IM online tutorial

description	part No.	part No.
- female insert with 1 RJ45 female-female coupler - male insert for 1 RJ45 male crimp connector, (without RJ45 connector, to be ordered separately) or connecting cables - male insert for 1 RJ45 male IDC connector, 8 data contacts (without RJ45 connector, to be ordered separately) ¹⁾	CX 01 J8F CX 01 J8M CX 01 J8IM	
RJ45 male crimp connector, 8 data contacts		CX 8 J6M
RJ45 male IDC connector, 8 data contacts		CX 8 J6IM

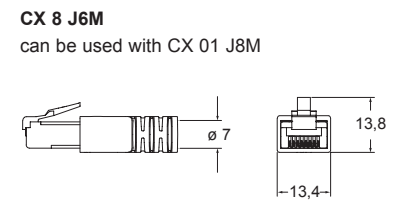
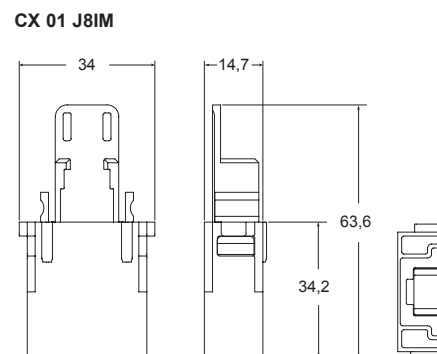
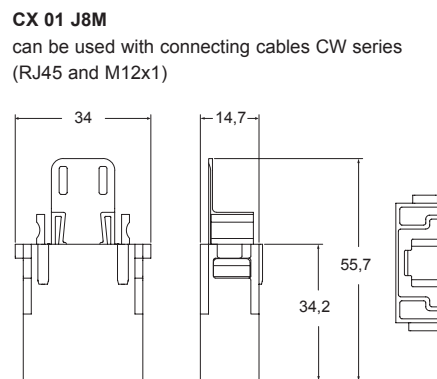
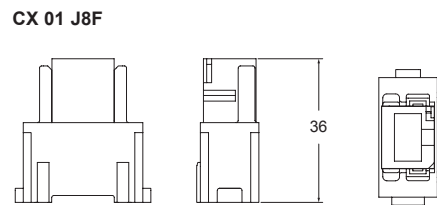
- CX 01 J8F technical data:**
- RJ45 female insert, Cat. 6 Class E_A
 - shielding housing: zinc diecast
 - housing finish: nickel-plated
 - current carrying capacity at 50 °C: 1A
 - adequate for Power over Ethernet: PoE according to IEEE 802.3af
 - connectors: IEC 60603-7-5
 - adequate for 10 Gigabit Ethernet: 10 Gigabit Ethernet acc. to IEEE 802.3an
 - custom-designed cabling systems: PROFINET Installation Guideline
 - generic cabling systems: ANSI/TIA/EIA-568-C.2 ISO/IEC 11801 EN 50173-1 ISO/IEC 24702 EN 61918
 - Class E_A (channel): ISO/IEC 11801, EN 50173-1

- CX 8 J6M technical data:**
- RJ45 male crimp connectors Cat. 6_A
 - crimp pliers: **CJPZ T**
 - screened cable stripper: **CJST**
 - current carrying capacity at 50 °C: 1A
 - Cu-conductor diameter solid: 0,40 - 0,51 mm (AWG 26/1 - 24/1) stranded: 0,46 - 0,61 mm (AWG 27/7 - 24/7)
 - insulation diameter: 0,85 - 1,05 mm
 - cable diameter: 5,0 - 6,6 mm
 - connectors: IEC 60603-7-51
 - 10 Gigabit Ethernet acc. to IEEE 802.3an: adequate for 10 Gigabit Ethernet
 - category 6_A: ISO/IEC 11801; EN 50173-1
 - Class E_A: ISO/IEC 11801; EN 50173-1
 - Category 6_A: ANSI/TIA/EIA-568-C.2

- CX 8 J6IM technical data:**
- RJ45 male IDC connectors Cat. 6 Class E_A
 - Cu-conductor diameter solid: 0,41 - 0,64 mm (AWG 26/1 - 22/1) stranded: 0,48 - 0,76 mm (AWG 26/7 - 22/7)
 - insulation diameter: 0,85 - 1,6 mm
 - current carrying capacity at 50 °C: 1A
 - cable diameter: 5,5 - 7,3 mm
 - connectors: IEC 60603-7-5
 - category 6_A: ISO/IEC 11801; DIN EN 50173-1
 - wrenches pliers for CX 8 J6IM: **CJPW K**
 - 10 Gigabit Ethernet acc. to IEEE 802.3an: adequate for 10 Gigabit Ethernet
 - Class E_A: ISO/IEC 11801; EN 50173-1
 - Category 6: ANSI/TIA/EIA-568-C.2
 - custom-designed cabling systems: according to PROFINET Installation Guideline

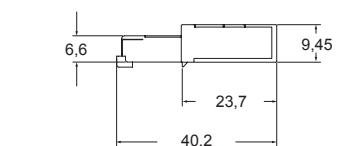
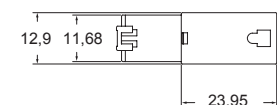
WARNING: inserts can be used on high enclosures or bulkhead housings only.

¹⁾ CX 01 J8IM: to be used with high enclosures (T-TYPE hood M32 / M40 only and CZAV/MZAV top entry hood only), bulkhead housings or COB ... BC/TCQ/TSF/ TSFS only.



for free cable end X-coded DTW X...W (M12x1)

CX 8 J6IM
can be used with CX 01 J8IM



for free cable end X-coded DTW...W (M12x1)

CW RJ45 patch cord

with 2 RJ45 male connectors



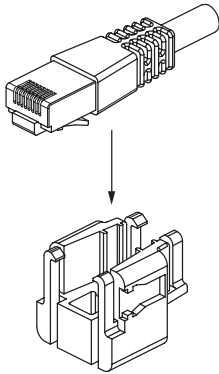
description	part No.	(L) metre
-------------	----------	--------------

RJ45 male connector with 8 data contacts	CW 1 J2M87	1
	CW 2 J2M87	2
	CW 3 J2M87	3
	CW 5 J2M87	5
	CW 7.5J2M87	7,5
	CW 10 J2M87	10
	CW 15 J2M87	15

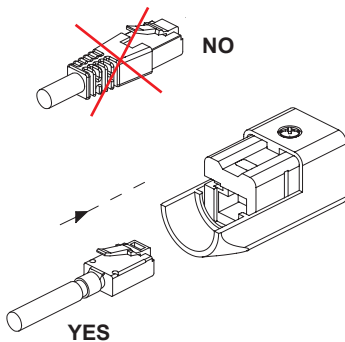
RJ45 patch cord technical data:
 - S/FTP Cat. 7 PUR
 - temperature range: from -40 °C ÷ +75 °C
 - nickel plated brass screening
 - green RAL 6018 colour

Can be used with:
 - MIXO RJ45 **CX 01 J8M** male inserts
 - RJ45 universal patch cord adapter **CJK 8M** (see page 233)
 - **CJK 8MT** adapters (see page 226)

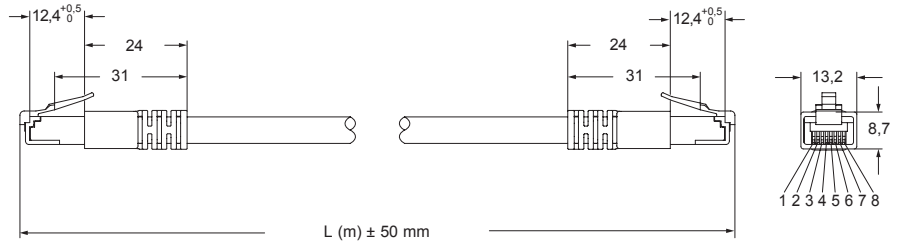
CJK 8MT male assembly



CJK 8FT to be used in VG or IAP enclosures with male crimp version



CW...J2M87



Wiring Diagram

1	—————	1
2	—————	2
3	—————	3
4	—————	4
5	—————	5
6	—————	6
7	—————	7
8	—————	8
S	—————	S

MIXO DATA

for 1 RJ45 + 4 poles connector 10A - 250V





The modular inserts must be installed in suitable frames, which are then mounted in traditional enclosures or in COB panel supports.

frames for modular units

page: 316

- characteristics according to EN 61984:

10A 250V 4kV 3

-  (UL for USA and Canada),   

 certified

- insulation resistance: $\geq 10 \text{ G}\Omega$

- made of self-extinguishing thermoplastic resin UL 94V-0

- mechanical life: ≥ 500 cycles

- contact resistance: $\leq 3 \text{ m}\Omega$

- **it is recommended to crimp the contacts with crimping tools homologated by ILME** (please see the crimping tool section 10A contacts, CDF and CDM series) on pages 708 - 741

housing for RJ45 + 4 poles connector



RJ45 connectors



description	part No.	part No. data contacts only	part No. data contacts/+2 power contacts
-------------	----------	--------------------------------	---

without RJ45 connector and without contacts (to be ordered separately)

- female inserts for 1 RJ45 female connector

CX 01 JF

and for 4 10A (CDF) female contacts ¹⁾

- male inserts for 1 RJ45 male connector

CX 01 JM

and for 4 10A (CDM) male contacts

RJ45 coupler jack, 8 data contacts ²⁾

CX 8 JF

RJ45 coupler jack, 8 data contacts / 2 power contacts ²⁾

CX 8/2 JF

RJ45 plug, 4 data contacts

CX 4 JM

RJ45 plug, 4 data contacts / 2 power contacts

CX 4/2 JM

RJ45 plug, 6 data contacts / 2 power contacts

CX 6/2 JM

RJ45 plug, 8 data contacts **Cat. 5e**

CX 8 JM

RJ45 plug, 4 data contacts **Cat. 5e ProfiNET®**

CX 4E JM

RJ45 connector features:

- RJ45 insert, **Cat. 5 Ethernet**

- rated current: 2,1A at 70 °C

- rated voltage: 50VDC / 35VAC

- IDC terminals:

for 0,22 mm² (AWG 24/7) data contacts **CX 4 JM**

for 0,14 mm² (AWG 26/7) or 0,22 mm² (AWG 24/7) data contacts **CX 4/2 JM**

for 0,34 mm² (AWG 22/7) or 0,38 mm² (AWG 22/19) power contacts **CX 4/2 JM**

for 0,14 mm² (AWG 26/7) data contacts **CX 6/2 JM**

for 0,25 mm² (AWG 23/19) power contacts **CX 6/2 JM**

for 0,14 mm² (AWG 26/7) data contacts **CX 8 JM**

for 0,34 mm² (AWG 22/7) data contacts **CX 4E JM**

- /7 = 7-strands wire

- /19 = 19-strands wire

- insulation diameter: 1 mm (data), 1,4 mm (power and CX 4E JM)

- \varnothing_{max} complete cable 7 mm (CX 8 JM: 6,9 mm)

- temperature range: from -40°C to 120 °C

- nickel plated brass screening

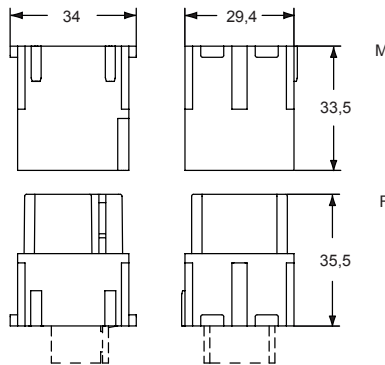
- crimp pliers: **CJPZ Y**

- screened cable stripper: **CJST**

¹⁾ WARNING:

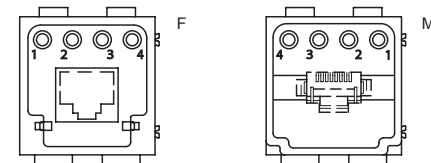
the female inserts can only be used on high or flush mounting enclosures

CX 01 JF, CX 01 JM



contacts side (front view)

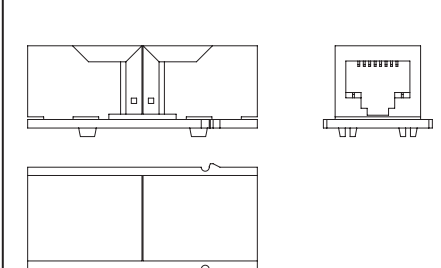
side with reference arrow ▲



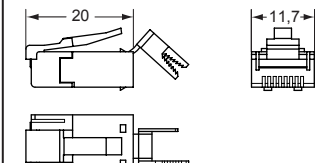
- 2 frame slots

²⁾ 4-pole version on request, part No. **CX 4 JF** and **CX 4/2 JF** with "crossover" link

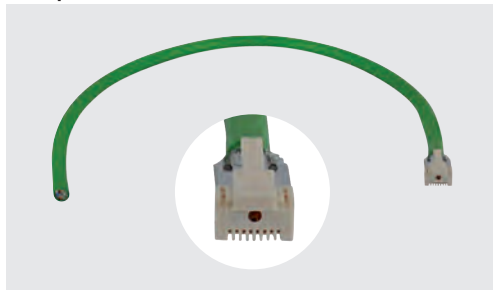
CX 4 JF, CX 4/2 JF, CX 8 JF, CX 8/2 JF



CX 4 JM, CX 4/2 JM, CX 6/2 JM, CX 8 JM, CX 4E JM



CW patch cord RJ45

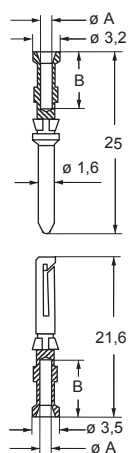


CW JM from page 308

10A crimp contacts, silver and gold plated



description	part No.	part No.
10A female crimp contacts		
0,14-0,37 mm ² AWG 26-22 identification No. 1	CDFA 0.3	CDFD 0.3
0,5 mm ² AWG 20 identification No. 2	CDFA 0.5	CDFD 0.5
0,75 mm ² AWG 18 identification No. ②	CDFA 0.7	CDFD 0.7
1 mm ² AWG 18 identification No. 3	CDFA 1.0	CDFD 1.0
1,5 mm ² AWG 16 identification No. 4	CDFA 1.5	CDFD 1.5
2,5 mm ² AWG 14 identification No. 5	CDFA 2.5	CDFD 2.5
	silver plated	gold plated+
10A male crimp contacts		
0,14-0,37 mm ² AWG 26-22 identification No. 1	CDMA 0.3	CDMD 0.3
0,5 mm ² AWG 20 identification No. 2	CDMA 0.5	CDMD 0.5
0,75 mm ² AWG 18 identification No. ②	CDMA 0.7	CDMD 0.7
1 mm ² AWG 18 identification No. 3	CDMA 1.0	CDMD 1.0
1,5 mm ² AWG 16 identification No. 4	CDMA 1.5	CDMD 1.5
2,5 mm ² AWG 14 identification No. 5	CDMA 2.5	CDMD 2.5



CDF and CDM contacts

conductor section (mm ²)	conductor slot $\varnothing A$ (mm)	conductors stripping length B (mm)
0,14-0,37	0,9	8
0,5	1,1	8
0,75	1,3	8
1,0	1,45	8
1,5	1,8	8
2,5	2,2	6

+ for basic or high thickness gold plating, please refer to page 674

for 2 RJ45 + 8 poles connector 10A - 250V

The modular inserts must be installed in suitable frames, which are then mounted in traditional enclosures or in COB panel supports.

page: 316

frames for modular units

- characteristics according to EN 61984:

10A 250V 4kV 3

- cULus (UL for USA and Canada),   

 **ERIC** certified

- insulation resistance: $\geq 10 \text{ G}\Omega$

- made of self-extinguishing thermoplastic resin UL 94V-0

- mechanical life: ≥ 500 cycles

- contact resistance: $\leq 3 \text{ m}\Omega$

- **it is recommended to crimp the contacts with crimping tools homologated by ILME** (please see the crimping tool section 10A contacts, CDF and CDM series) on pages 708 - 741

housing for RJ45 + 8 poles connector



RJ45 connectors



description	part No.	part No. data contacts only	part No. data contacts/+2 power contacts
-------------	----------	--------------------------------	---

without RJ45 connector and without contacts (to be ordered separately)

- female insert for 2 RJ45 female connectors

CX 02 JF

and for 8 10A (CDF) female contacts ¹⁾

- male insert for 2 RJ45 male connectors

CX 02 JM

and for 8 10A (CDM) male contacts

RJ45 coupler jack, 8 data contacts ²⁾

CX 8 JF

RJ45 coupler jack, 8 data contacts / 2 power contacts ²⁾

CX 8/2 JF

RJ45 plug, 4 data contacts

CX 4 JM

RJ45 plug, 4 data contacts / 2 power contacts

CX 4/2 JM

RJ45 plug, 6 data contacts / 2 power contacts

CX 6/2 JM

RJ45 plug, 8 data contacts **Cat. 5e**

CX 8 JM

RJ45 plug, 4 data contacts **Cat. 5e ProfINET®**

CX 4E JM

RJ45 connector features:

- RJ45 insert, **Cat. 5 Ethernet**

- rated current: 2,1A at 70 °C

- rated voltage: 50VDC / 35VAC

- IDC terminals:

for 0,22 mm² (AWG 24/7) data contacts **CX 4 JM**

for 0,14 mm² (AWG 26/7) or 0,22 mm² (AWG 24/7) data contacts **CX 4/2 JM**

for 0,34 mm² (AWG 22/7) or 0,38 mm² (AWG 22/19) power contacts **CX 4/2 JM**

for 0,14 mm² (AWG 26/7) data contacts **CX 6/2 JM**

for 0,25 mm² (AWG 23/19) power contacts **CX 6/2 JM**

for 0,14 mm² (AWG 26/7) data contacts **CX 8 JM**

for 0,34 mm² (AWG 22/7) data contacts **CX 4E JM**

- /7 = 7-strands wire

- /19 = 19-strands wire

- insulation diameter: 1 mm (data), 1,4 mm (power and CX 4E JM)

- \varnothing_{max} complete cable 7 mm (CX 8 JM: 6,9 mm)

- temperature range: from -40°C to 120 °C

- nickel plated brass screening

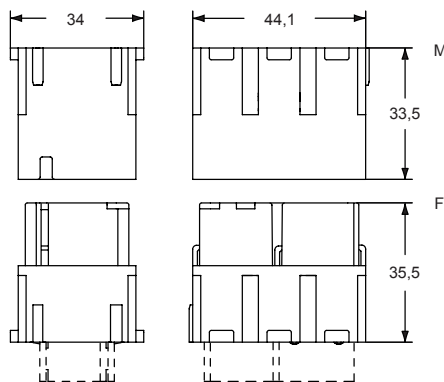
- crimp pliers: **CJPZ Y**

- screened cable stripper: **CJST**

¹⁾ **WARNING:**

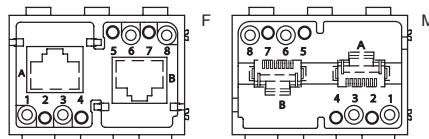
the female inserts can only be used on high or flush mounting enclosures

CX 02 JF, CX 02 JM



contacts side (front view)

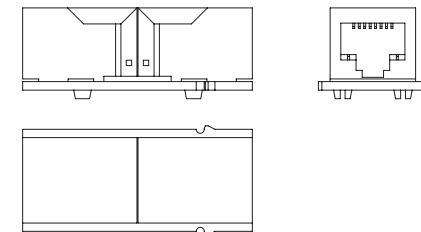
side with reference arrow ▲



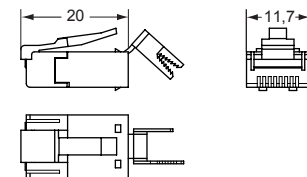
- 3 frame slots

²⁾ 4-pole version on request, part No. **CX 4 JF** and **CX 4/2 JF** with "crossover" link

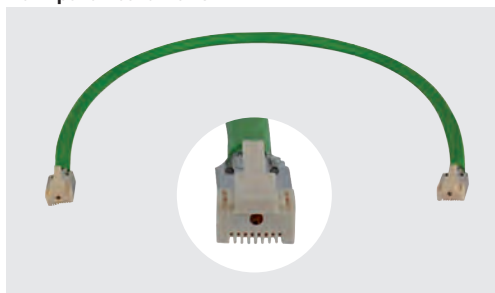
CX 4 JF, CX 4/2 JF, CX 8 JF, CX 8/2 JF



CX 4 JM, CX 4/2 JM, CX 6/2 JM, CX 8 JM, CX 4E JM



CW patch cord RJ45



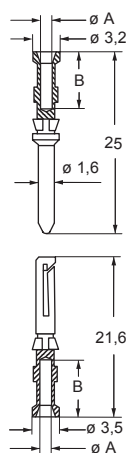
CW J2M from page 308

MIXO DATA

10A crimp contacts, silver and gold plated



description	part No.	part No.
10A female crimp contacts		
0,14-0,37 mm ² AWG 26-22 identification No. 1	CDFA 0.3	CDFD 0.3
0,5 mm ² AWG 20 identification No. 2	CDFA 0.5	CDFD 0.5
0,75 mm ² AWG 18 identification No. ②	CDFA 0.7	CDFD 0.7
1 mm ² AWG 18 identification No. 3	CDFA 1.0	CDFD 1.0
1,5 mm ² AWG 16 identification No. 4	CDFA 1.5	CDFD 1.5
2,5 mm ² AWG 14 identification No. 5	CDFA 2.5	CDFD 2.5
10A male crimp contacts		
0,14-0,37 mm ² AWG 26-22 identification No. 1	CDMA 0.3	CDMD 0.3
0,5 mm ² AWG 20 identification No. 2	CDMA 0.5	CDMD 0.5
0,75 mm ² AWG 18 identification No. ②	CDMA 0.7	CDMD 0.7
1 mm ² AWG 18 identification No. 3	CDMA 1.0	CDMD 1.0
1,5 mm ² AWG 16 identification No. 4	CDMA 1.5	CDMD 1.5
2,5 mm ² AWG 14 identification No. 5	CDMA 2.5	CDMD 2.5



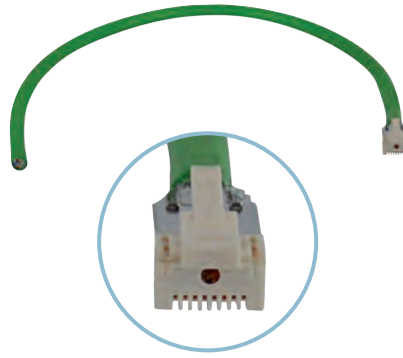
CDF and CDM contacts

conductor section (mm ²)	conductor slot $\varnothing A$ (mm)	conductors stripping length B (mm)
0,14-0,37	0,9	8
0,5	1,1	8
0,75	1,3	8
1,0	1,45	8
1,5	1,8	8
2,5	2,2	6

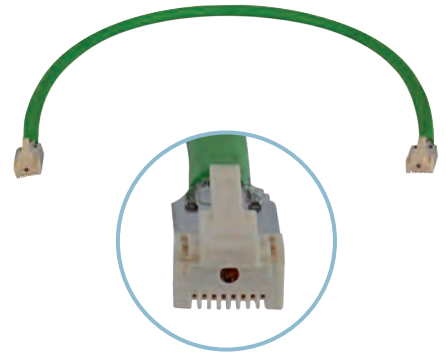
‡ for basic or high thickness gold plating, please refer to page 674

CW patch cord RJ45

with 1 RJ45 male connector



with 2 RJ45 male connectors



description	part No.	(L) metre	part No.	(L) metre
RJ45 male connector with 4 data contacts / 2 power contacts	CW 0.5 JM4/2	0.5		
	CW 2 JM4/2	2		
	CW 5 JM4/2	5		
	CW 10 JM4/2	10		
RJ45 male connector with 8 data contacts	CW 0.5 JM8	0.5	CW 0.5 J2M8	0.5
	CW 2 JM8	2	CW 2 J2M8	2
	CW 5 JM8	5	CW 5 J2M8	5
	CW 10 JM8	10	CW 10 J2M8	10
RJ45 male connector with 4 data contacts, Cat. 5e	CW 0.5 JM4E	0.5	CW 0.5 J2M4E	0.5
	CW 2 JM4E	2	CW 2 J2M4E	2
	CW 5 JM4E	5	CW 5 J2M4E	5
	CW 10 JM4E	10	CW 10 J2M4E	10

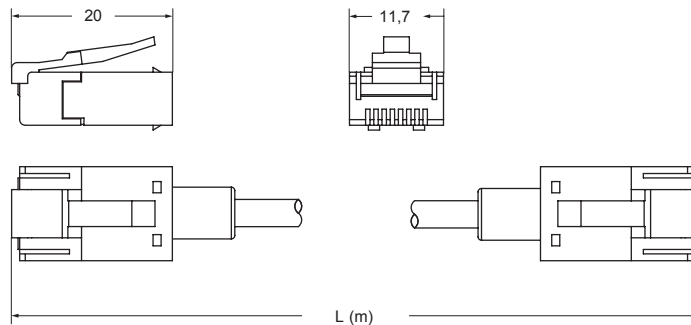
RJ45 connector features:

- insert RJ45, Cat. 5 Ethernet
- nominal current: 2,1A at 70 °C
- nominal voltage: 50V DC / 35V AC
- temperature range: from -40 °C to +120 °C
- nickel plated brass screening

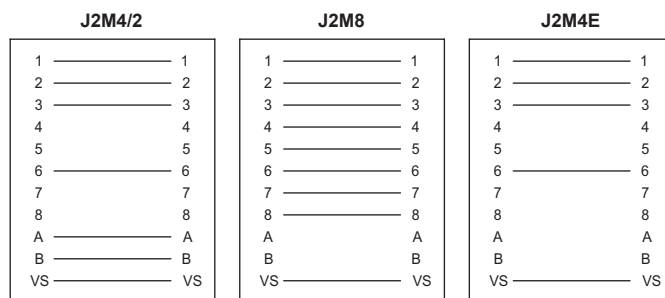
Can be used with:

- MIXO RJ45: CX 01 JM and CX 02 JM male inserts see pages 304 and 306

CW JM 4/2, 8, 4E and CW J2M 4/2, 8, 4E



Wiring Diagram



MIXO DATA

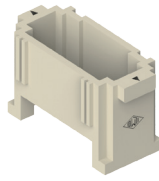
CX FM

The modular inserts must be installed in suitable frames, which are then mounted in traditional enclosures or in COB panel supports.
 Alternatively, individual modules with a width of 14,7 mm can be installed in plastic supports.

frames for modular units

page:
316

dummy module



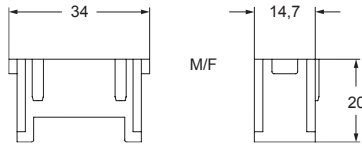
description

part No.

dummy module for unused frame seats

CX FM

Remark:
 This version is formed by a single piece and has a reduced height.
 It allows the mating of a MIXO insert including it with a corresponding MIXO insert even having - in front of the dummy module - a regular male or female module equipped with contacts, which obviously will not work.
 The sole exceptions to this feature are that an insert with this dummy module cannot mate an insert showing in front a CX 3/4 XDF/M, CX 04 XF/M or CX 02 HF module.



- 1 frame slot


MIXO units

MIXO a-f frame for housings

Enclosures

RJ45 MIXO CONNECTOR Cat 6^A

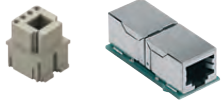
RJ45 female/female coupler



CX 01 J8F


RJ45 MIXO CONNECTOR Cat 5-5e

1x RJ45 female/female coupler
+ 4x 10A crimp contacts

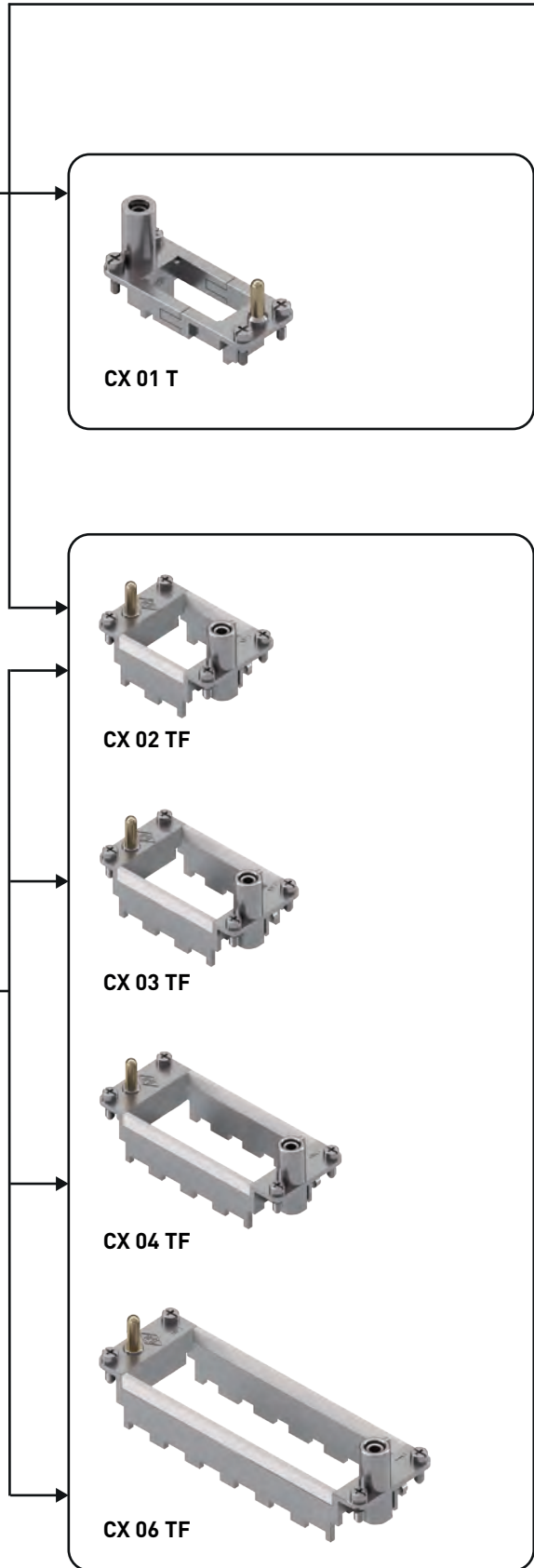


CX 01 JF+ CX 8 JF
or
CX 8/2 JF

2x RJ45 female/female coupler
+ 8x 10A crimp contacts



CX 02 JF + 2x CX 8 JF
or
2x CX 8/2 JF



MIXO ONE

CZ IL-BRID

C-TYPE

C7 IP68

V-TYPE

T-TYPE

W-TYPE

EMC

LS-TYPE

COB

IP68

Central lever

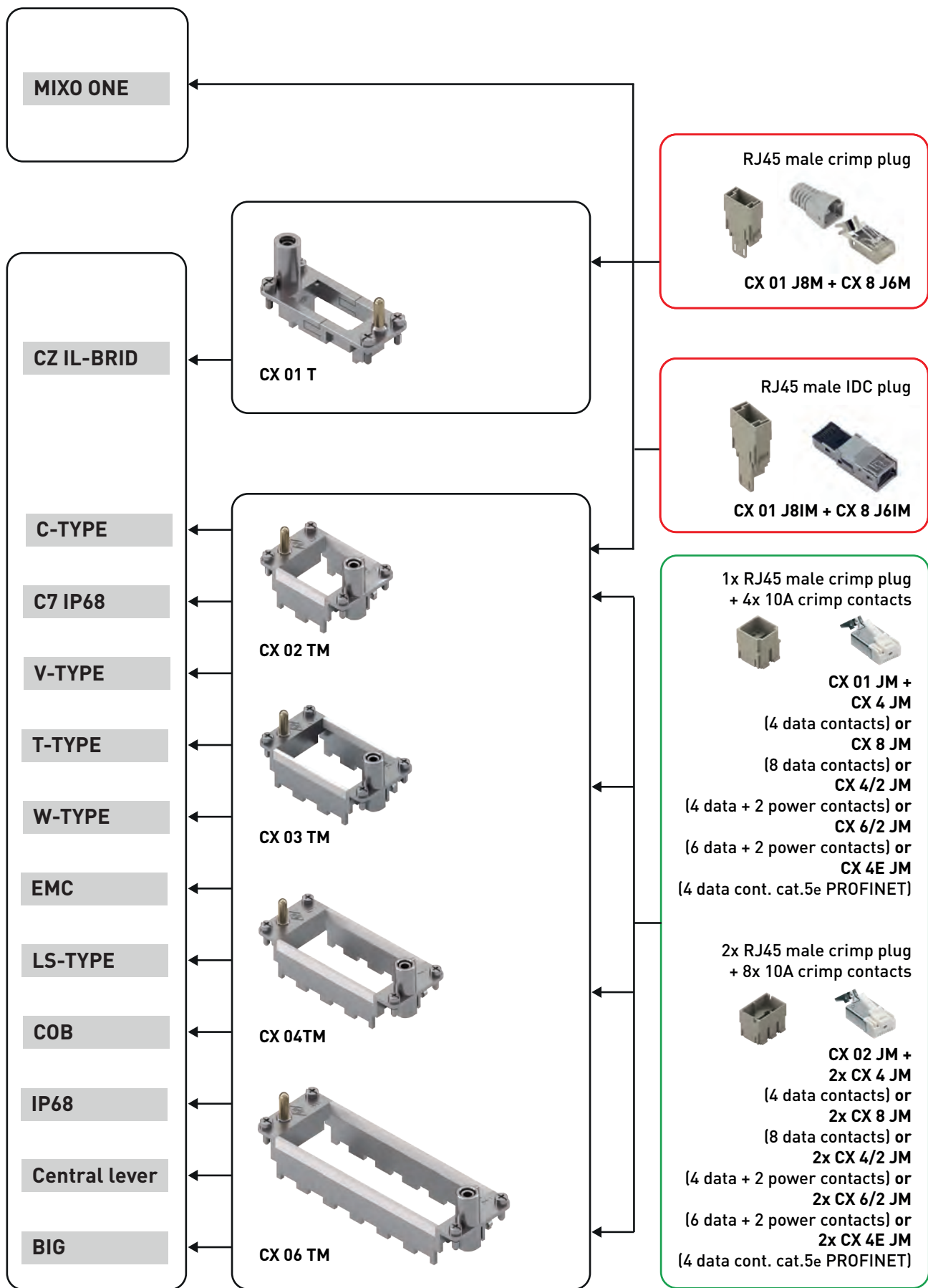
BIG

MIXO RJ45

Enclosures

MIXO A-F frame for hoods

MIXO units



MIXO RJ45

CX 03 P - CX 02 P for pneumatic contacts

The modular inserts must be installed in suitable frames which are then mounted in traditional enclosures or in COB panel support.
Single-sized modular units may be directly mounted inside MIXO ONE enclosures.

	page:
frames for modular units	316 - 317
MIXO ONE enclosures	369

modular units with 3 seats



modular units with 2 seats



description

part No.

part No.

without contacts (to be ordered separately)
inserts with 3 housings for tube Ø 1,6 - 4,0

CX 03 P

without contacts (to be ordered separately)
inserts with 2 housings for tube Ø 6,0

CX 02 P

- certified
- insulation resistance: $\geq 10 \text{ G}\Omega$
- made of self-extinguishing thermoplastic resin UL 94V-0
- mechanical life: ≥ 500 cycles

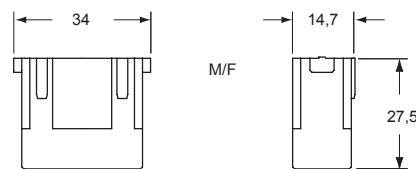
Use of units for pneumatic contacts

- identical male and female modular units
- pneumatic contacts for pressure values up to 8 bar, for use with clean and dry compressed air
- use of tubes with Ø 1,6 - 3 - 4 and 6 mm, and possible replacement of tubes with assembled units
- possibility of using tubes with different diameters in the same modular unit
- female contacts with or without closing valve
- working temperature range - 40 °C ÷ + 80 °C

Warnings:

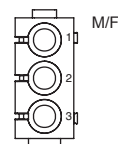
CRM/F CX coding and guiding pins must be used for pneumatic contacts modules.
These pins also provide coding if pneumatic contacts modules are used exclusively.

The use of pneumatic contacts requires an appropriate filtering and dehydration system to prevent dangerous condensation.
Contacts may be used for pressure values of up to a maximum of 8 bars/116 psi.

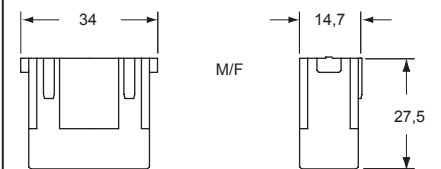


contacts side (front view)

side with reference arrow ▲

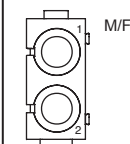


- 1 frame slot



contacts side (front view)

side with reference arrow ▲



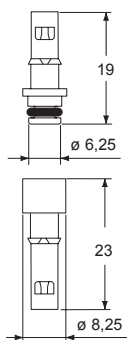
- 1 frame slot

**pneumatic contacts
with or without closing valve**

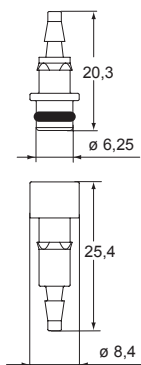


description	part No.
female contacts without closing valve	
- for tubes with internal \varnothing 1,6 mm	CX 1.6 PF
- for tubes with internal \varnothing 3 mm	CX 3.0 PF
- for tubes with internal \varnothing 4 mm	CX 4.0 PF
- for tubes with internal \varnothing 6 mm	CX 6.0 PF
male contacts without closing valve	
- for tubes with internal \varnothing 1,6 mm	CX 1.6 PM
- for tubes with internal \varnothing 3 mm	CX 3.0 PM
- for tubes with internal \varnothing 4 mm	CX 4.0 PM
- for tubes with internal \varnothing 6 mm	CX 6.0 PM
female contacts with closing valve	
- for tubes with internal \varnothing 1,6 mm	CX 1.6 VC
- for tubes with internal \varnothing 3 mm	CX 3.0 VC
- for tubes with internal \varnothing 4 mm	CX 4.0 VC
- for tubes with internal \varnothing 6 mm	CX 6.0 VC
male contact (use contacts without closing valve)	

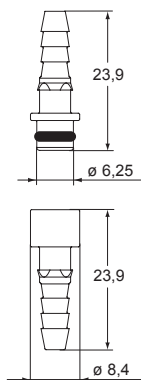
CX 1.6 PF/PM/VC



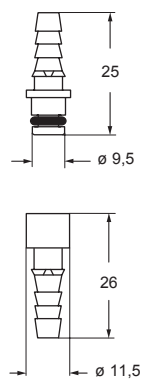
CX 3.0 PF/PM/VC



CX 4.0 PF/PM/VC



CX 6.0 PF/PM/VC

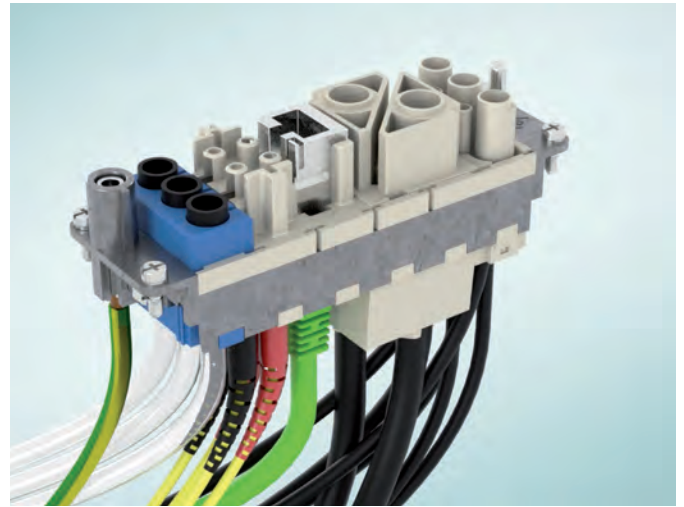


MIXO FRAMES

Made of die-cast zinc alloy
with protective earth (PE) contacts

SUM UP

- ❑ Die-cast zinc alloy frames
- ❑ Protective earth (PE)
- ❑ Possibility of mounting female and male modular units on the same frame
- ❑ Polarisation on frames
- ❑ When two or more identical connectors of the MIXO series are used, use of coding pins (CR...CX series) may prevent incorrect coupling



TECHNICAL FEATURES

MIXO FRAMES

HOW TO SELECT FRAMES

1 Calculate the number of frame slots taken up by the required inserts (frame slot 1, 2 or 3 modules).



	No. of frame slots
CX 01 9VF/M	1
CX 01 9VTF	1
CX 01 GF/M	1
CX 01 J8	1
CX 01 UF/M	1
CX 02 4AF/M	1
CX 02 4BF/M	1
CX 02 4F/M	1
CX 02 7F/M	1
CX 02 CHF/M	1
CX 02 P	1
CX 03 4F/M	1
CX 03 4BF/M	1
CX 03 P	1
CX 3/4 XDF/M	1
CX 04 LF/M	1
CX 04 RF/M	1
CX 04 SCF/M	1
CX 04 XF/M	1
CX 05 SF/M	1
CX 05 SHF/M	1
CX 06 CF/M	1
CX 06P CF/M	1
CX 08 CF/M	1
CX 08 I6F/M	1
CX 12 DF/M	1
CX 17 DF/M	1
CX 25 IBF/M	1
CX 25 IF/M	1
CX FM	1



	No. of frame slots
CX 01 JF/M	2
CX 01 YF/M	2
CX 01 YPEF/M	2
CX 02 BF/M	2
CX 02 GF/M	2
CX 02 HF/M	2
CX 20 CF/M	2
CX 42 DF/M	2



	No. of frame slots
CX 02 JF/M	3

2 Select the right frame according to the number of required modules (available 1, 2, 3, 4 and 6 modules).

CX 01 T
1 module



CX 02 TF/TM
2 modules



CX 03 TF/TM
3 modules



CX 04 TF/TM
4 modules



CX 06 TF/TM
6 modules



Fill the unused frame slots with CX FM dummy module



Possibility to use the MIXO **HNM frames** (provided with special gold plated PE contacts) together with R series of crimp contacts and the relevant connector hoods and housings, to produce where

required an **HNM** connector (High Number of Matings, up to 10.000 cycles of operation).

CX 01 T

enclosures: size "49.16"	page:
IL-BRID	374 - 377, 382
CZ7 IP67, single lever	384
W-TYPE for aggressive environments	519
E-Xtreme® corrosion proof	540
EMC	576
panel supports:	page:
COB + adaptor	652 - 654

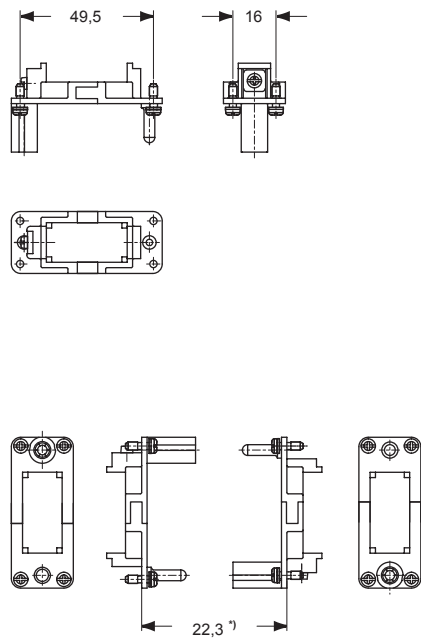
frames for modular units



description	part No.
-------------	----------

for CZ enclosures	CX 01 T
-------------------	---------

- die-cast zinc alloy frames
- protective earth (PE)
- coding pins **CR..CX**



*) distance for electric contacts: max 24 mm
 distance for pneumatic contacts: max 23,5 mm

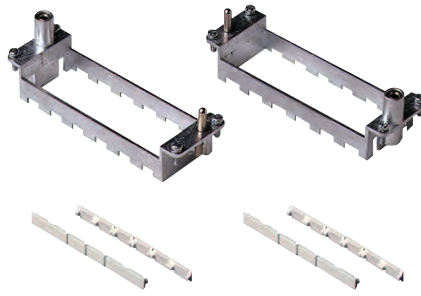
- small earth terminal for cables from 1-2,5 mm²,
 AWG 18-14

MIXO INSERTS

CX 02 TM/TF, CX 03 TM/TF, CX 04 TM/TF, CX 06 TM/TF

enclosures:	page:
C-TYPE IP65 or IP66/IP69	387 - 430
C7 IP67	436 - 442
V-TYPE IP65 or IP66/IP69	444 - 463
BIG hoods	466 - 473
T-TYPE IP65 insulating	480 - 487
T-TYPE / W IP66/IP69 insulating	489 - 492
HYGIENIC T-TYPE / H IP66/IP69	501 - 504
HYGIENIC T-TYPE / C IP66/IP69, -50 °C	506 - 509
W-TYPE for aggressive environments	521 - 526
E-Xtreme® corrosion proof	530 - 537
	542 - 547
	550 - 557
EMC	578 - 581
Central lever	603 - 614
LS-TYPE	618 - 625
IP68	632 - 647
panel supports:	page:
COB	652 - 653

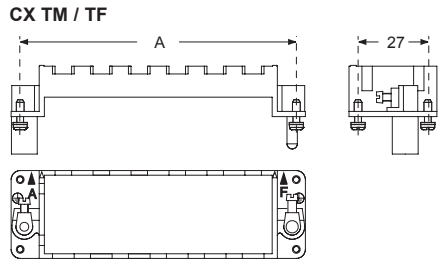
frames for modular units with lock-in tab (included)



description	part No.	part No.
frames for modular units, with lock-in tab included	type for hoods*	type for housings*
for 2 modular units - for housing size 44.27	CX 02 TM	CX 02 TF
for 3 modular units - for housing size 57.27	CX 03 TM	CX 03 TF
for 4 modular units - for housing size 77.27 and 77.62	CX 04 TM	CX 04 TF
for 6 modular units - for housing size 104.27 and 104.62	CX 06 TM	CX 06 TF

- die-cast zinc alloy frames
- protective earth (PE)
- possibility of mounting female and male modular units on the same frame
- frames supplied with lock-in tab to attach units
- polarisation on frames
- coding pins **CR..CX**
- for spare lock-in tab **CX CFM** see SPARE SPARTS catalogue

* Assignment of attribute "for hoods" or "for housings" is merely conventional: both types can be mounted either in a hood or in a housing. In a modular connector coupling there shall be always a frame type "M" and a frame type "F".

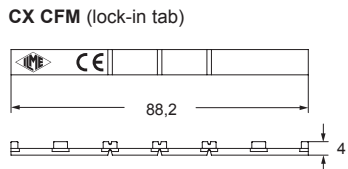
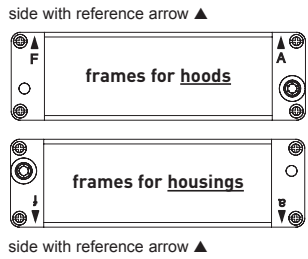


part No.	A (mm)	for housings size
CX 02 TM / TF	44	44.27
CX 03 TM / TF	57	57.27
CX 04 TM / TF	77,5	77.27 and 77.62
CX 06 TM / TF	104	104.27 and 104.62

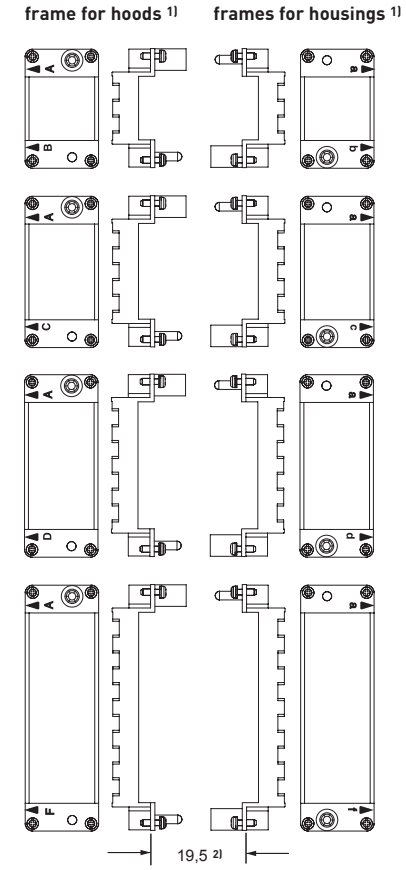
Earth terminal
 - large: for cables from 4-6 mm², AWG 12-10
 - small: for cables from 1-2,5 mm², AWG 18-14

In order to accommodate larger PE conductor cross-sectional area, use CGT PE adapters, see page 319.

position of modules (contact side view)



Polarisation of frames with relative identification letters and couplings



- 1) Warning:**
 The module support frames are marked:
 - FOR HOODS: **upper-case A-B, A-C, A-D and A-F**
 - FOR HOUSINGS: **lower-case a-b, a-c, a-d and a-f**
- Positioning the modules in the frames according to the respective letters is ensuring the specular assembly of modules, for which the hood will be coupled correctly to the housing.
- 2) Distance for:**
 - electric and fibre optic contacts: max 21 mm
 - pneumatic contacts: max 20,5 mm

MIXO INSERTS

CGT 6.0 – CGT 10 – CGT 16 – CGT 25

PE terminal adapters for MIXO frames

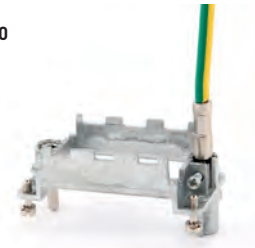
- **PE terminal adapter CGT 6.0** made of nickel plated brass that allows to connect by crimping a 6 mm² / 10 AWG flexible copper conductor **to the small PE terminal** (2,5 mm² / 14 AWG) of a MIXO frame, in case the connector needs a second PE line sized 6 mm²/10 AWG when the large PE terminal (6 mm²/10 AWG) of the MIXO frame is already occupied by a large size PE conductor, by using the existing PE terminal adapter **CGT 16**, or the new ones for the large PE terminal, **CGT 10 or CGT 25**.

- **PE terminal adapters CGT 10 and CGT 25** made of nickel plated brass that allow to connect by crimping respectively a 10 mm² / 8 AWG or a 25 mm² / 4 AWG flexible copper conductor **to the large PE terminal** (6 mm²/10 AWG) of a MIXO frame.

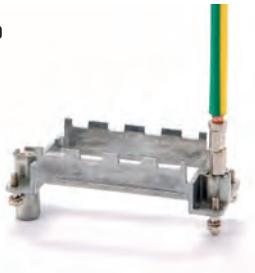
- They are offered in addition to the existing PE terminal adapter **CGT 16** for 16 mm² / 6 AWG protective earth conductor – introduced with MIXO 100A modules **CX 02 G and CX 01 G** – to give more flexibility for the combination of MIXO 100A and 70A high power modules with **multi-core cables**, that have the PE conductor of the same size of the phase conductors.

- Crimping is achieved by using the already available manual hydraulic crimping tool **CPPZ C** (Cembre HT 45) with hexagonal crimping dies **CGD 10 C** (for **CGT 10** with 10 mm² / 8 AWG and for **CGT 6.0** with 6 mm² / 10 AWG flexible copper conductors) and **CGD 25 C** (for **CGT 25** with 25 mm² / 4 AWG flexible copper conductors).

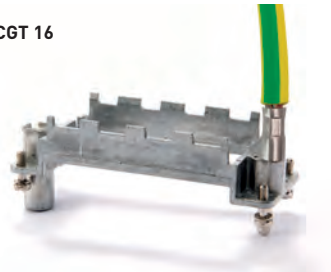
CGT 6.0



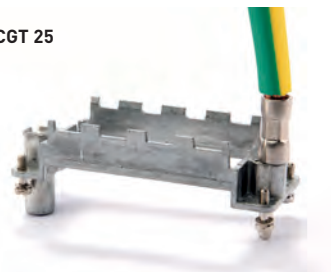
CGT 10



CGT 16



CGT 25



CGT 6.0 - CGT 10 - CGT 16 - CGT 25

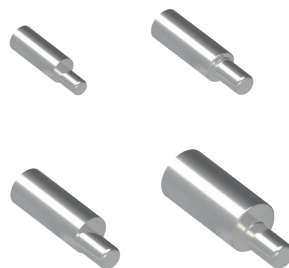
The modular inserts must be installed in suitable frames, which are then mounted in traditional enclosures or in COB panel supports.

frames for modular units page:
316 - 317

To be used in surface mounting housings or low construction hoods.

Cannot be used with T-TYPE surface mounting housings and horizontal cable outlet hoods.

PE terminal adapter



headless screw M4X6



description	part No.	part No.
-------------	----------	----------

PE wire terminal adapter 6 mm ² (10 AWG)	CGT 6.0
PE wire terminal adapter 10 mm ² (8 AWG)	CGT 10
PE wire terminal adapter 16 mm ² (6 AWG)	CGT 16
PE wire terminal adapter 25 mm ² (4 AWG)	CGT 25

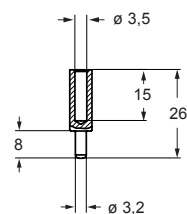
headless screw M4X6, stainless steel, kit of 10 pcs. ¹⁾	CR VGM4
--	----------------

¹⁾ For the use with T-TYPE bulkhead housings and vertical entry hoods it is needed to replace the M4 screw of the 6 mm² PE contact of the frame with the headless screw **CR VGM4**.

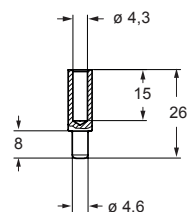
How to use the PE terminal adapter

- 1) Strip 15 mm of flexible PE wire.
- 2) Crimp the cable on the CGT adapter by using the CPPZ C pliers with the dies as follows:
 - **CGD 10 C** for 6 mm² and 10 mm²
 - **CGD 16 C** for 16 mm²
 - **CGD 25 C** for 25 mm²
- 3) Fix the adapter tip in the larger earth terminal (6 mm²) for CGT 10, CGT 16, CGT 25 or in the smaller earth terminal (2,5 mm²) for CGT 6.0 of frames CX...TM/TF.

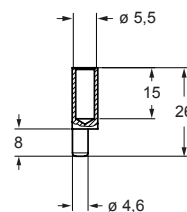
CGT 6.0



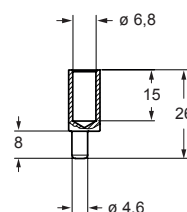
CGT 10



CGT 16



CGT 25



cURus pending

MODULES FOR HIGH NUMBER OF MATINGS

Within the range of **series HNM**, for High Number of Matings, all MIXO modules for crimp contacts 40 A, 16 A and/or 10 A, combined with the use of especially high thickness gold-plated/lubricated crimp contacts of:

- series **RX** (40 A HNM variant of series CX),
- series **RC** (16 A HNM variant of series CC), and
- series **RD** (10 A HNM variant of series CD)

mounted in the dedicated **MIXO HNM frames** cat. nos. **RX 02 /03 /04 /06 TF /TM**, also employing especially gold-plated PE contacts, allow the creation of **HNM** modular connector inserts.

The connector modules of series MIXO that by using HNM 40 A contacts series **RX**, HNM 16 A contacts series **RC** and/or HNM 10 A contacts series **RD** together with **MIXO HNM frames** RX 02...06 TF/M can create MIXO HNM modular connector inserts are:

- **CX 02 4F/M, CX 03 4F/M, CX 03 4BF/M** and **CX 04 XF/XM** (with **RX** HNM contacts)
- **CX 3/4 XDF/M** (with **RX** and **RD** HNM contacts)
- **CX 06 CF/M, CX 06P CF/M, CX 08 CF/M** and **CX 20 CF/M** (with **RC** HNM contacts)
- **CX 12 DF/M, CX 17 DF/M** and **CX 42 DF/M** (with **RD** HNM contacts)



SUM UP

- ☑ **Up to 10.000 matings in combination with HNM enclosures**
- ☑ **Up to 5.000 matings with standard hoods with single lever**

Q NOTE

For contacts in **HNM** version (series **RI, RD, RC** and **RX**) the same tools are suitable for crimping, insertion/extraction (where indicated), as those used for the corresponding contacts in standard version (respectively series **CI, CD, CC** and **CX**).



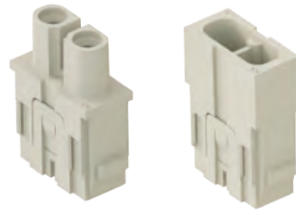
The modular inserts must be installed in suitable frames, which are then mounted in traditional enclosures* or in COB panel supports.

frames for modular units*

page: 333

* enclosures: bulkhead mounting housings, high construction housings or high construction hoods

modular units, crimp connections



Q 10.000 MATINGS WITH HNM FRAMES AND HNM ENCLOSURES

Q 5.000 MATINGS WITH HNM FRAMES AND STANDARD ENCLOSURES, SINGLE LEVER

40A crimp contacts gold plated



description	part No.	part No.
-------------	----------	----------

without contacts (to be ordered separately)
female inserts for female contacts ¹⁾
male inserts for male contacts ¹⁾

CX 02 4F
CX 02 4M

40A female crimp contacts
1,5 mm² AWG 16
2,5 mm² AWG 14
4 mm² AWG 12
6 mm² AWG 10
10 mm² AWG 8

RXF2D 1.5
RXF2D 2.5
RXF2D 4.0
RXF2D 6.0
RXF2D 10

gold plated

40A male crimp contacts
1,5 mm² AWG 16
2,5 mm² AWG 14
4 mm² AWG 12
6 mm² AWG 10
10 mm² AWG 8

RXM2D 1.5
RXM2D 2.5
RXM2D 4.0
RXM2D 6.0
RXM2D 10

¹⁾ cable diameter up to 7,5 mm
contact size up to 10 mm²

- characteristics according to EN 61984:

40A 1000V 8kV 3

- certified

- rated voltage according to UL/CSA: 600V

- insulation resistance: ≥ 10 GΩ

- ambient temperature limit: -40 °C ... +125 °C

- made of self-extinguishing thermoplastic resin UL 94V-0

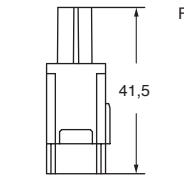
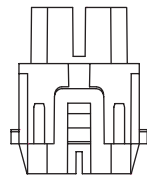
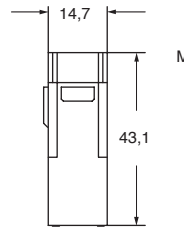
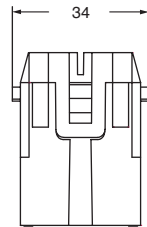
- mechanical life: ≥ 10.000 cycles

- contact resistance: ≤ 0,3 mΩ

- can be mated with CX 02 A/B modules

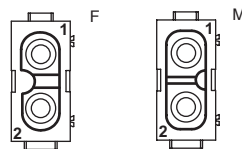
- **it is recommended to crimp the contacts** (1,5 - 10 mm²), **with crimping tools homologated by ILME** (please see the crimping tool section 40A contacts, RXF2D and RXM2D series) on pages 708 - 741

- for max. current load see the connector inserts derating diagram below; for more information see page 28

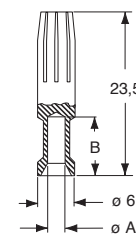
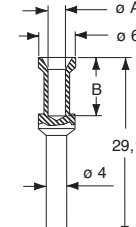


contacts side (front view)

side with reference arrow ▲



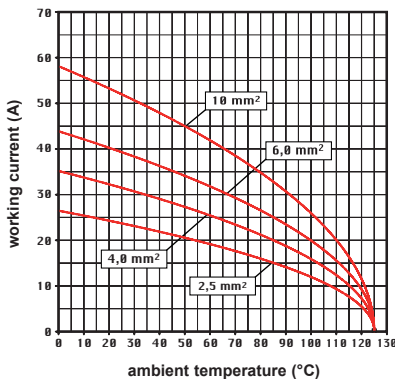
- 1 frame slot



RXF2D and RXM2D contacts

conductor section (mm ²)	conductor slot ø A (mm)	conductor stripping length B (mm)
1,5	1,8	9
2,5	2,2	9
4	2,85	9,6
6	3,5	9,6
10	4,3	15

CX 02 4, 2 poles connector inserts
Maximum current load derating diagram

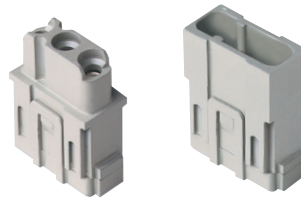


The modular inserts must be installed in suitable frames, which are then mounted in traditional enclosures or in COB panel supports.

frames for modular units

page: 333

modular units, crimp connections



40A crimp contacts gold plated



Q 10.000 MATINGS WITH HNM FRAMES AND HNM ENCLOSURES

Q 5.000 MATINGS WITH HNM FRAMES AND STANDARD ENCLOSURES, SINGLE LEVER

description	part No.	part No.
-------------	----------	----------

without contacts (to be ordered separately)
 female inserts for female contacts ¹⁾
 male inserts for male contacts ¹⁾

CX 03 4F
CX 03 4M

40A female crimp contacts
 1,5 mm² AWG 16
 2,5 mm² AWG 14
 4 mm² AWG 12
 6 mm² AWG 10

RXF2D 1.5
RXF2D 2.5
RXF2D 4.0
RXF2D 6.0

gold plated

40A male crimp contacts
 1,5 mm² AWG 16
 2,5 mm² AWG 14
 4 mm² AWG 12
 6 mm² AWG 10

RXM2D 1.5
RXM2D 2.5
RXM2D 4.0
RXM2D 6.0

¹⁾ cable diameter up to 5 mm

- characteristics according to EN 61984:

40A 400/690V 6kV 3

- cULus (UL for USA and Canada),

- certified

- rated voltage according to UL/CSA: 600V

- insulation resistance: ≥ 10 GΩ

- ambient temperature limit: -40 °C ... +125 °C

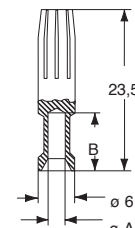
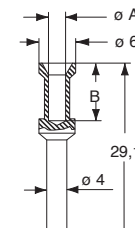
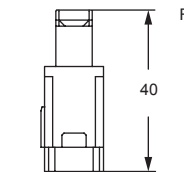
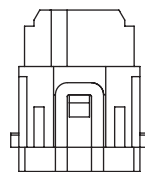
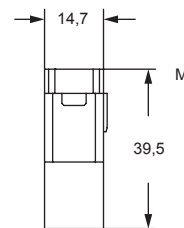
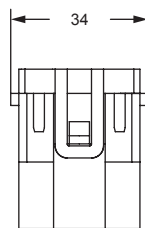
- made of self-extinguishing thermoplastic resin UL 94V-0

- mechanical life: ≥ 10.000 cycles

- contact resistance: ≤ 0,3 mΩ

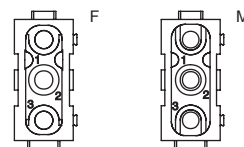
- **it is recommended to crimp the contacts with crimping tools homologated by ILME** (please see the crimping tool section 40A contacts, RXF2D and RXM2D series) on pages 708 - 741

- for max. current load see the connector inserts derating diagram below; for more information see page 28



contacts side (front view)

side with reference arrow ▲

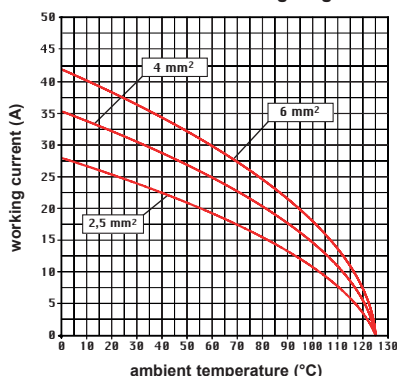


- 1 frame slot

RXF2D and RXM2D contacts

conductor section (mm ²)	conductor slot ø A (mm)	conductor stripping length B (mm)
1,5	1,8	9
2,5	2,2	9
4	2,85	9,6
6	3,5	9,6

CX 03 4, 3 poles connector inserts
Maximum current load derating diagram





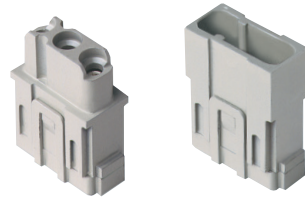
The modular inserts must be installed in suitable frames, which are then mounted in traditional enclosures* or in COB panel supports.

frames for modular units*

page: 333

* enclosures: bulkhead mounting housings, high construction housings or high construction hoods

modular units, crimp connections



Q 10.000 MATINGS WITH HNM FRAMES AND HNM ENCLOSURES

Q 5.000 MATINGS WITH HNM FRAMES AND STANDARD ENCLOSURES, SINGLE LEVER

40A crimp contacts gold plated



description	part No.	part No.
-------------	----------	----------

without contacts (to be ordered separately)
female inserts for female contacts ¹⁾
male inserts for male contacts ¹⁾

CX 03 4BF
CX 03 4BM

40A female crimp contacts
1,5 mm² AWG 16
2,5 mm² AWG 14
4 mm² AWG 12
6 mm² AWG 10
10 mm² AWG 8

RXF2D 1.5
RXF2D 2.5
RXF2D 4.0
RXF2D 6.0
RXF2D 10

gold plated

40A male crimp contacts
1,5 mm² AWG 16
2,5 mm² AWG 14
4 mm² AWG 12
6 mm² AWG 10
10 mm² AWG 8

RXM2D 1.5
RXM2D 2.5
RXM2D 4.0
RXM2D 6.0
RXM2D 10

¹⁾ cable diameter up to 7,5 mm
contact size up to 10 mm²

- characteristics according to EN 61984:

40A 500V 6kV 3

- cULus (UL for USA and Canada),

- certified

- rated voltage according to UL/CSA: 600V

- insulation resistance: ≥ 10 GΩ

- ambient temperature limit: -40 °C ... +125 °C

- made of self-extinguishing thermoplastic resin

UL 94V-0

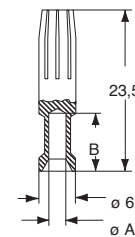
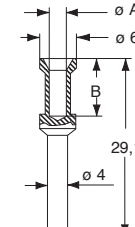
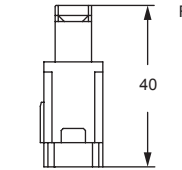
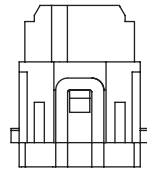
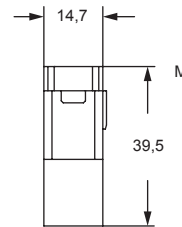
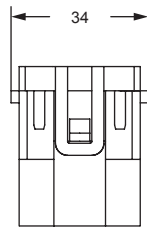
- mechanical life: ≥ 10.000 cycles

- contact resistance: ≤ 0,3 mΩ

- **it is recommended to crimp the contacts**

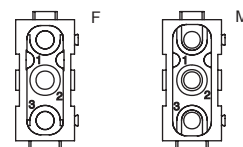
(1,5 - 10 mm²), **with crimping tools homologated by ILME** (please see the crimping tool section 40A contacts, RXF2D and RXM2D series) on pages 708 - 741

- for max. current load see the connector inserts derating diagram below; for more information see page 28



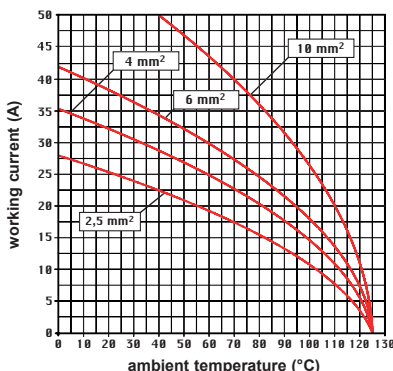
contacts side (front view)

side with reference arrow ▲



- 1 frame slot

CX 03 4B, 3 poles connector inserts
Maximum current load derating diagram



RXF2D and RXM2D contacts

conductor section (mm ²)	conductor slot ø A (mm)	conductor stripping length B (mm)
1,5	1,8	9
2,5	2,2	9
4	2,85	9,6
6	3,5	9,6
10	4,3	15

CX 3/4 XDF/M 3 p (40A - 830V) + 4 p (10A - 830V) HNM (High Number of Matings)

The modular inserts must be installed in suitable frames, which are then mounted in traditional enclosures or in COB panel supports.

page:

frames for modular units

333

- male and female contacts finger proof
- their key characteristic lies in the fact that they guarantee maximum safety even in case of accidental contact with fingers (IP2X or IPXXB). Safety is guaranteed as standard on female contacts, but also on male contacts. This feature is important as it ensures full compliance with the recent safety standard EN 60204-1, concerning electric equipment fitted on machines and in particular with the requirements of Article 6.2.4 concerning protection against residual voltage. In the case of plugs or similar devices, the withdrawal of which results in the exposure of conductors (for example pins), the discharge time shall not exceed 1 s, otherwise such conductors shall be protected against direct contact to at least an IP2X or IPXXB.

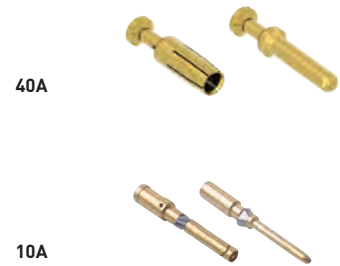
modular units, crimp connections



Q 10.000 MATINGS WITH HNM FRAMES AND HNM ENCLOSURES

Q 5.000 MATINGS WITH HNM FRAMES AND STANDARD ENCLOSURES, SINGLE LEVER

40A and 10A crimp contacts gold plated



description

part No.

part No

without contacts (to be ordered separately)

female inserts for female contacts

CX 3/4 XDF

male inserts for male contacts

CX 3/4 XDM

40A female crimp contacts

1,5 mm ²	AWG 16
2,5 mm ²	AWG 14
4 mm ²	AWG 12
6 mm ²	AWG 10

RXF2D 1.5
RXF2D 2.5
RXF2D 4.0
RXF2D 6.0

40A male crimp contacts

1,5 mm ²	AWG 16
2,5 mm ²	AWG 14
4 mm ²	AWG 12
6 mm ²	AWG 10

RXM2D 1.5
RXM2D 2.5
RXM2D 4.0
RXM2D 6.0

10A female crimp contacts

0,14-0,37 mm ²	AWG 26-22	identification No. 1
0,5 mm ²	AWG 20	identification No. 2
0,75 mm ²	AWG 18	identification No. ②
1 mm ²	AWG 18	identification No. 3
1,5 mm ²	AWG 16	identification No. 4
2,5 mm ²	AWG 14	identification No. 5

RDF2D 0.3
RDF2D 0.5
RDF2D 0.7
RDF2D 1.0
RDF2D 1.5
RDF2D 2.5

10A male crimp contacts

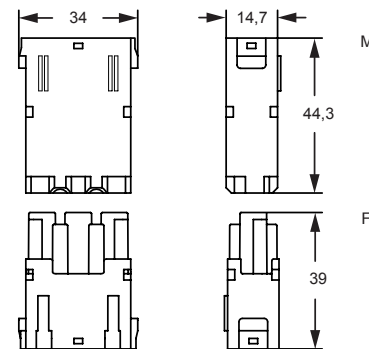
0,14-0,37 mm ²	AWG 26-22	identification No. 1
0,5 mm ²	AWG 20	identification No. 2
0,75 mm ²	AWG 18	identification No. ②
1 mm ²	AWG 18	identification No. 3
1,5 mm ²	AWG 16	identification No. 4
2,5 mm ²	AWG 14	identification No. 5

RDM2D 0.3
RDM2D 0.5
RDM2D 0.7
RDM2D 1.0
RDM2D 1.5
RDM2D 2.5

gold plated

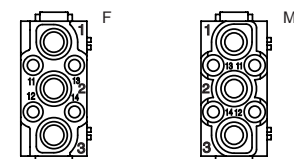
- characteristics according to EN 61984:

- 3 poles 40A 830V 8kV 3
- 4 poles 10A 830V 8kV 3
- cULus (UL for USA and Canada), CE, DNV-GL
- Bureau Veritas EAC certified
- rated voltage according to UL/CSA: 600V
- insulation resistance: ≥ 10 GΩ
- ambient temperature limit: -40 °C ... +125 °C
- made of self-extinguishing thermoplastic resin UL 94V-0
- mechanical life: ≥ 10.000 cycles
- contact resistance: ≤ 0,3 mΩ (3 poles), ≤ 3 mΩ (4 poles)
- for max. current load see the connector inserts derating diagram below; for more information see page 28



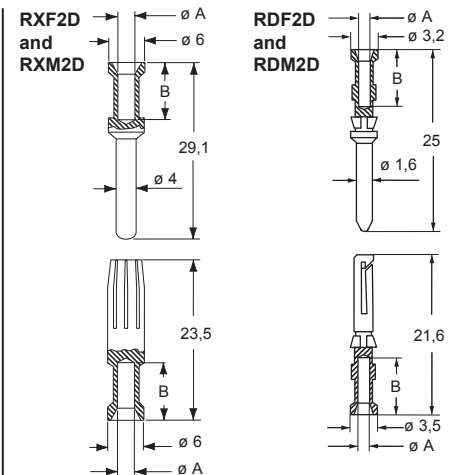
contacts side (front view)

side with reference arrow ▲



- 1 frame slot

- it is recommended to crimp the contacts with crimping tools homologated by ILME (please see the crimping tool section 40A contacts, RXF2D, RXM2D series and 10A contacts RDF2D, RDM2D series) on pages 708 - 741



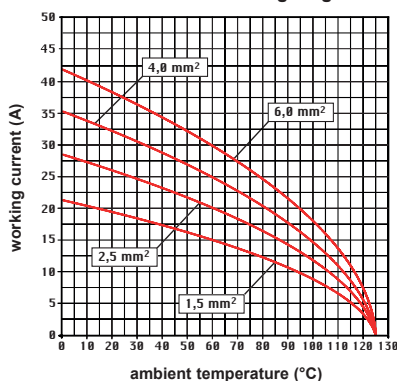
RXF2D and RXM2D contacts

conductor section (mm ²)	conductor slot ø A (mm)	conductors stripping length B (mm)
1,5	1,8	9
2,5	2,2	9
4	2,85	9,6
6	3,5	9,6

RDF2D and RDM2D contacts

0,14-0,37	0,9	8
0,5	1,1	8
0,75	1,3	8
1,0	1,45	8
1,5	1,8	8
2,5	2,2	6

CX 3/4 poles connector inserts
Maximum current load derating diagram





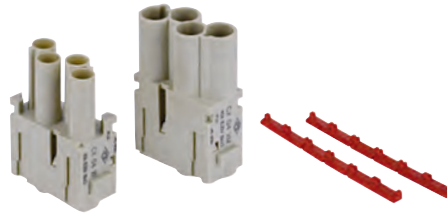
The modular inserts must be installed in suitable frames, which are then mounted in traditional enclosures* or in COB panel supports.

frames for modular units*

page: 333

* enclosures: bulkhead mounting housings, high construction housings or high construction hoods

modular units, crimp connections with red lock-in tab (included)



Q 10.000 MATINGS WITH HNM FRAMES AND HNM ENCLOSURES

Q 5.000 MATINGS WITH HNM FRAMES AND STANDARD ENCLOSURES, SINGLE LEVER

40A crimp contacts gold plated



description	part No.	part No.
-------------	----------	----------

without contacts (to be ordered separately)
(module red lock-in tab included)
female inserts for female contacts
male inserts for male contacts

CX 04 XF
CX 04 XM

40A female crimp contacts
1,5 mm² AWG 16
2,5 mm² AWG 14
4 mm² AWG 12
6 mm² AWG 10

RXF2D 1.5
RXF2D 2.5
RXF2D 4.0
RXF2D 6.0

gold plated

40A male crimp contacts
1,5 mm² AWG 16
2,5 mm² AWG 14
4 mm² AWG 12
6 mm² AWG 10

RXM2D 1.5
RXM2D 2.5
RXM2D 4.0
RXM2D 6.0

- characteristics according to EN 61984:

40A 830V 8kV 3
40A 1000V 8kV 2

- cULus (UL for USA and Canada),

certified

- rated voltage according to UL/CSA: 600V

- insulation resistance: $\geq 10 \text{ G}\Omega$

- ambient temperature limit: -40 °C ... +125 °C

- made of self-extinguishing thermoplastic resin UL 94V-0

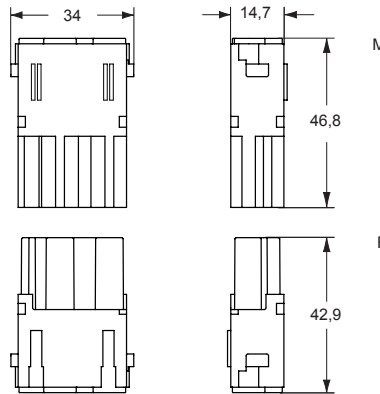
- mechanical life: ≥ 10.000 cycles

- contact resistance: $\leq 0,3 \text{ m}\Omega$

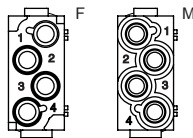
- for spare lock-in tab **CX CFMX** see SPARE SPARTS catalogue

- it is recommended to crimp the contacts with crimping tools homologated by ILME (please see the crimping tool section 40A contacts, RXF2D and RXM2D series) on pages 708 - 741

- for max. current load see the connector inserts derating diagram below; for more information see page 28

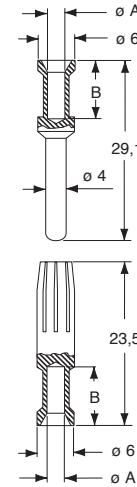
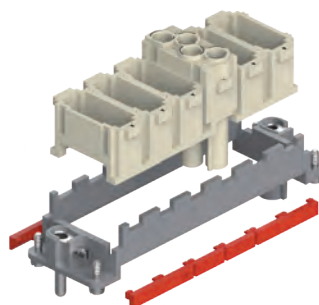


contacts side (front view)
side with reference arrow ▲



- 1 frame slot

Female inserts are supplied with two red lock tab that must be used instead of those supplied with the frames.

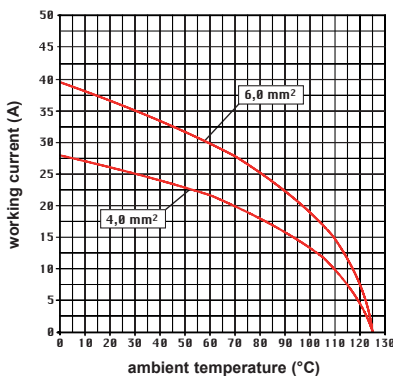


RXF2D and RXM2D contacts

conductor section (mm ²)	conductor slot ø A (mm)	conductor stripping length B (mm)
1,5	1,8	9
2,5	2,2	9
4	2,85	9,6
6	3,5	9,6

- male and female contacts finger proof
- their key characteristic lies in the fact that they guarantee maximum safety even in case of accidental contact with fingers (IP2X or IPXXB). Safety is guaranteed as standard on female contacts, but also on male contacts. This feature is important as it ensures full compliance with the recent safety standard EN 60204-1, concerning electric equipment fitted on machines and in particular with the requirements of Article 6.2.4 concerning protection against residual voltage. In the case of plugs or similar devices, the withdrawal of which results in the exposure of conductors (for example pins), the discharge time shall not exceed 1 s, otherwise such conductors shall be protected against direct contact to at least an IP2X or IPXXB.

CX 04 poles connector inserts
Maximum current load derating diagram



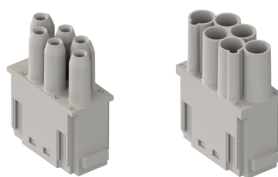
The modular inserts must be installed in suitable frames, which are then mounted in traditional enclosures or in COB panel supports.

frames for modular units

page: 333

- we recommend the use of CRF / CRM coding pins

modular units, crimp connections



RATING 830V

Q 10.000 MATINGS WITH HNM FRAMES AND HNM ENCLOSURES

Q 5.000 MATINGS WITH HNM FRAMES AND STANDARD ENCLOSURES, SINGLE LEVER

16A crimp contacts gold plated



description

part No.

part No.

without contacts (to be ordered separately)
female inserts for female contacts
male inserts for male contacts

CX 06P CF
CX 06P CM

16A female contacts

0,14-0,37 mm ²	AWG 26-22	one groove
0,5 mm ²	AWG 20	with no grooves
0,75 mm ²	AWG 18	one groove (back side)
1 mm ²	AWG 18	one groove
1,5 mm ²	AWG 16	two grooves
2,5 mm ²	AWG 14	three grooves
3 mm ²	AWG 12	one wide groove
4 mm ²	AWG 12	with no grooves

RCF2D 0.3
RCF2D 0.5
RCF2D 0.7
RCF2D 1.0
RCF2D 1.5
RCF2D 2.5
RCF2D 3.0
RCF2D 4.0

gold plated

16A male contacts

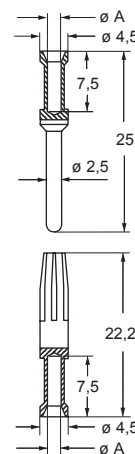
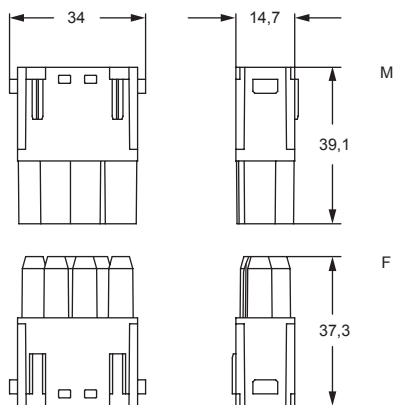
0,14-0,37 mm ²	AWG 26-22	one groove
0,5 mm ²	AWG 20	with no grooves
0,75 mm ²	AWG 18	one groove (back side)
1 mm ²	AWG 18	one groove
1,5 mm ²	AWG 16	two grooves
2,5 mm ²	AWG 14	three grooves
3 mm ²	AWG 12	one wide groove
4 mm ²	AWG 12	with no grooves

RCM2D 0.3
RCM2D 0.5
RCM2D 0.7
RCM2D 1.0
RCM2D 1.5
RCM2D 2.5
RCM2D 3.0
RCM2D 4.0

- characteristics according to EN 61984:

16A 830V 8kV 3

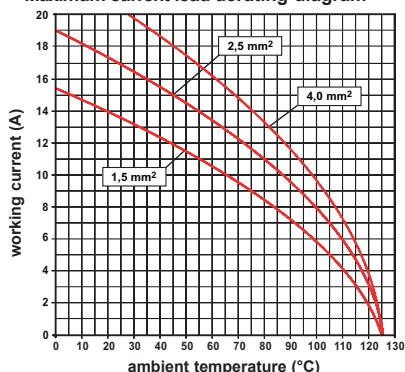
- **BUREAU VERITAS** certified
- rated voltage according to UL/CSA: 600V
- insulation resistance: ≥ 10 G Ω
- ambient temperature limit: -40 °C ... +125 °C
- made of self-extinguishing thermoplastic resin UL 94V-0
- mechanical life: ≥ 10.000 cycles
- contact resistance: ≤ 1 m Ω
- **it is recommended to crimp the contacts with crimping tools homologated by ILME** (please see the crimping tool section 16A contacts, RCF2D and RCM2D series) on pages 708 - 741
- for max. current load see the connector inserts derating diagram below; for more information see page 28



RCF2D and RCM2D contacts

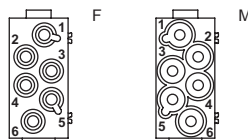
conductor section (mm ²)	conductor slot ϕA (mm)	conductors stripping length (mm)
0,14-0,37	0,9	7,5
0,5	1,1	7,5
0,75	1,3	7,5
1,0	1,45	7,5
1,5	1,8	7,5
2,5	2,2	7,5
3	2,55	7,5
4	2,85	7,5

CX..P 06 poles connector inserts
Maximum current load derating diagram



contacts side (front view)

side with reference arrow ▲



- 1 frame slot

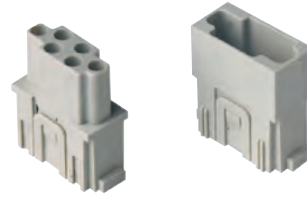


The modular inserts must be installed in suitable frames, which are then mounted in traditional enclosures or in COB panel supports.

frames for modular units

page: 333

modular units, crimp connections



Q 10.000 MATINGS WITH HNM FRAMES AND HNM ENCLOSURES

Q 5.000 MATINGS WITH HNM FRAMES AND STANDARD ENCLOSURES, SINGLE LEVER

16A crimp contacts gold plated



description	part No.	part No.
-------------	----------	----------

without contacts (to be ordered separately)
female inserts for female contacts
male inserts for male contacts

CX 06 CF
CX 06 CM

16A female contacts

Area (mm ²)	AWG	Configuration
0,14-0,37	26-22	one groove
0,5	20	with no grooves
0,75	18	one groove (back side)
1	18	one groove
1,5	16	two grooves
2,5	14	three grooves
3	12	one wide groove
4	12	with no grooves

RCF2D 0.3
RCF2D 0.5
RCF2D 0.7
RCF2D 1.0
RCF2D 1.5
RCF2D 2.5
RCF2D 3.0
RCF2D 4.0

gold plated

16A male contacts

Area (mm ²)	AWG	Configuration
0,14-0,37	26-22	one groove
0,5	20	with no grooves
0,75	18	one groove (back side)
1	18	one groove
1,5	16	two grooves
2,5	14	three grooves
3	12	one wide groove
4	12	with no grooves

RCM2D 0.3
RCM2D 0.5
RCM2D 0.7
RCM2D 1.0
RCM2D 1.5
RCM2D 2.5
RCM2D 3.0
RCM2D 4.0

- characteristics according to EN 61984:

16A 500V 6kV 3
16A 400/690V 6kV 2

- certified

- rated voltage according to UL/CSA: 600V

- insulation resistance: $\geq 10 \text{ G}\Omega$

- ambient temperature limit: $-40 \text{ }^\circ\text{C} \dots +125 \text{ }^\circ\text{C}$

- made of self-extinguishing thermoplastic resin UL 94V-0

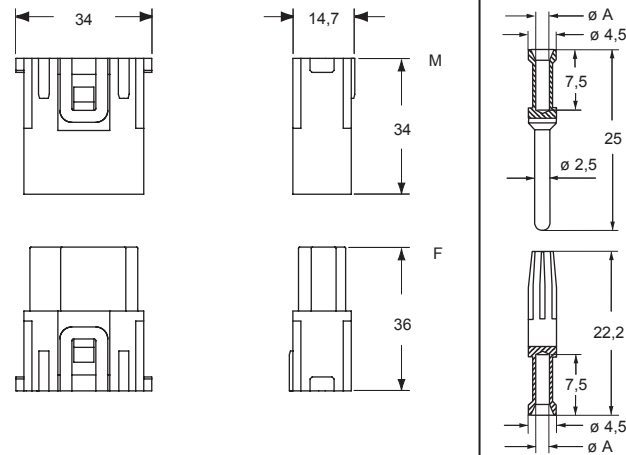
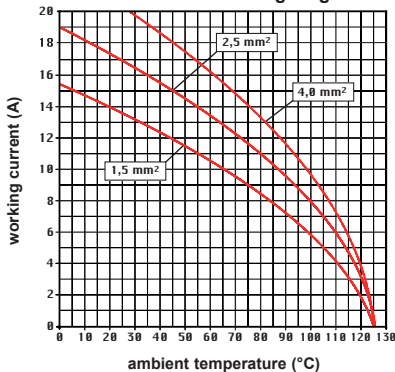
- mechanical life: ≥ 10.000 cycles

- contact resistance: $\leq 1 \text{ m}\Omega$

- it is recommended to crimp the contacts with crimping tools homologated by ILME (please see the crimping tool section 16A contacts, RCF2D and RCM2D series) on pages 708 - 741

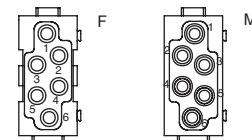
- for max. current load see the connector inserts derating diagram below; for more information see page 28

CX 06 poles connector inserts
Maximum current load derating diagram



contacts side (front view)

side with reference arrow ▲



- 1 frame slot

RCF2D and RCM2D contacts

conductor section mm ²	conductor slot ϕA (mm)	conductors stripping length (mm)
0,14-0,37	0,9	7,5
0,5	1,1	7,5
0,75	1,3	7,5
1,0	1,45	7,5
1,5	1,8	7,5
2,5	2,2	7,5
3	2,55	7,5
4	2,85	7,5

The modular inserts must be installed in suitable frames, which are then mounted in traditional enclosures or in COB panel supports.

frames for modular units

page: 333

modular units, crimp connections



Q 10.000 MATINGS WITH HNM FRAMES AND HNM ENCLOSURES

Q 5.000 MATINGS WITH HNM FRAMES AND STANDARD ENCLOSURES, SINGLE LEVER

16A crimp contacts gold plated



description

part No.

part No

without contacts (to be ordered separately)
female inserts for female contacts
male inserts for male contacts

CX 08 CF
CX 08 CM

16A female contacts

0,14-0,37 mm ²	AWG 26-22	one groove
0,5 mm ²	AWG 20	with no grooves
0,75 mm ²	AWG 18	one groove (back side)
1 mm ²	AWG 18	one groove
1,5 mm ²	AWG 16	two grooves
2,5 mm ²	AWG 14	three grooves
3 mm ²	AWG 12	one wide groove
4 mm ²	AWG 12	with no grooves

RCF2D 0.3
RCF2D 0.5
RCF2D 0.7
RCF2D 1.0
RCF2D 1.5
RCF2D 2.5
RCF2D 3.0
RCF2D 4.0

gold plated

16A male contacts

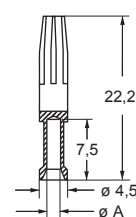
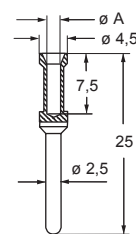
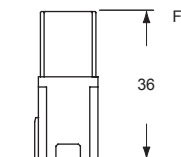
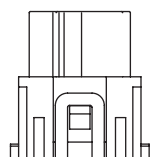
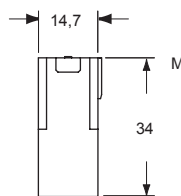
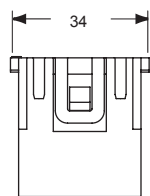
0,14-0,37 mm ²	AWG 26-22	one groove
0,5 mm ²	AWG 20	with no grooves
0,75 mm ²	AWG 18	one groove (back side)
1 mm ²	AWG 18	one groove
1,5 mm ²	AWG 16	two grooves
2,5 mm ²	AWG 14	three grooves
3 mm ²	AWG 12	one wide groove
4 mm ²	AWG 12	with no grooves

RCM2D 0.3
RCM2D 0.5
RCM2D 0.7
RCM2D 1.0
RCM2D 1.5
RCM2D 2.5
RCM2D 3.0
RCM2D 4.0

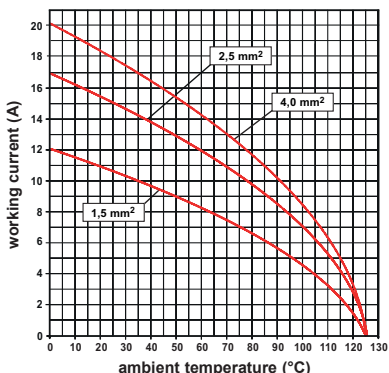
- characteristics according to EN 61984:

16A 500V 6kV 3
16A 400/690V 6kV 2

- certified
- rated voltage according to UL/CSA: 600V
- insulation resistance: ≥ 10 GΩ
- ambient temperature limit: -40 °C ... +125 °C
- made of self-extinguishing thermoplastic resin UL 94V-0
- mechanical life: ≥ 10.000 cycles
- contact resistance: ≤ 1 mΩ
- **it is recommended to crimp the contacts with crimping tools homologated by ILME** (please see the crimping tool section 16A contacts, RCF2D and RCM2D series) on pages 708 - 741
- for max. current load see the connector inserts derating diagram below; for more information see page 28

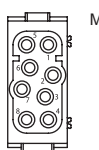
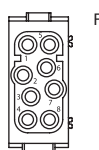


CX 08 C, 8 poles connector inserts
Maximum current load derating diagram



contacts side (front view)

side with reference arrow ▲



- 1 frame slot

RCF2D and RCM2D contacts

conductor section mm ²	conductor slot ø A (mm)	conductors stripping length (mm)
0,14-0,37	0,9	7,5
0,5	1,1	7,5
0,75	1,3	7,5
1,0	1,45	7,5
1,5	1,8	7,5
2,5	2,2	7,5
3	2,55	7,5
4	2,85	7,5

The modular inserts must be installed in suitable frames, which are then mounted in traditional enclosures or in COB panel supports.

frames for modular units

page: 333

modular units, crimp connections



Q 10.000 MATINGS WITH HNM FRAMES AND HNM ENCLOSURES

Q 5.000 MATINGS WITH HNM FRAMES AND STANDARD ENCLOSURES, SINGLE LEVER

16A crimp contacts gold plated



description	part No.	part No.
-------------	----------	----------

without contacts (to be ordered separately)

female inserts for female contacts ¹⁾

CX 20 CF

male inserts for male contacts ¹⁾

CX 20 CM

16A female contacts

Area (mm²)	AWG	Configuration
0,14-0,37	26-22	one groove
0,5	20	with no grooves
0,75	18	one groove (back side)
1	18	one groove
1,5	16	two grooves
2,5	14	three grooves
3	12	one wide groove
4	12	with no grooves

Contact Type
RCF2D 0.3
RCF2D 0.5
RCF2D 0.7
RCF2D 1.0
RCF2D 1.5
RCF2D 2.5
RCF2D 3.0
RCF2D 4.0

gold plated

16A male contacts

Area (mm²)	AWG	Configuration
0,14-0,37	26-22	one groove
0,5	20	with no grooves
0,75	18	one groove (back side)
1	18	one groove
1,5	16	two grooves
2,5	14	three grooves
3	12	one wide groove
4	12	with no grooves

Contact Type
RCM2D 0.3
RCM2D 0.5
RCM2D 0.7
RCM2D 1.0
RCM2D 1.5
RCM2D 2.5
RCM2D 3.0
RCM2D 4.0

¹⁾ on request, version with 3 fastened CX 20 CF/CM inserts with poles numbered from 1 - 60
references: **CX 60 CF, CX 60 CM**

- characteristics according to EN 61984:

16A 500V 6kV 3
16A 830V 8kV 2

- certified

UL ENEC ERI certified

- rated voltage according to UL/CSA: 600V

- insulation resistance: ≥ 10 GΩ

- ambient temperature limit: -40 °C ... +125 °C

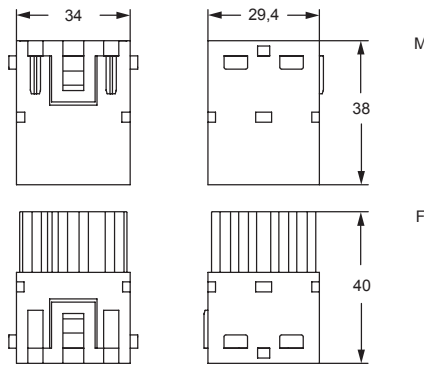
- made of self-extinguishing thermoplastic resin UL 94V-0

- mechanical life: ≥ 10.000 cycles

- contact resistance: ≤ 1 mΩ

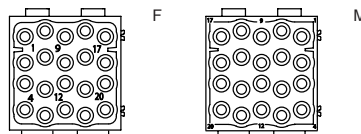
- **it is recommended to crimp the contacts with crimping tools homologated by ILME** (please see the crimping tool section 16A contacts, RCF2D and RCM2D series) on pages 708 - 741

- for max. current load see the connector inserts derating diagram below; for more information see page 28

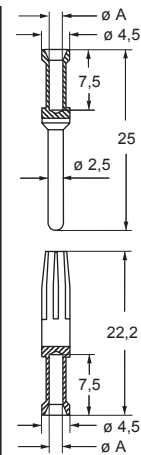


contacts side (front view)

side with reference arrow ▲



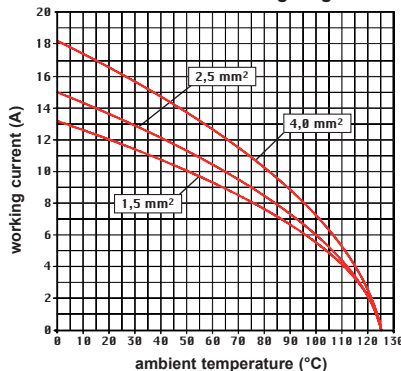
- 2 frame slots



RCF2D and RCM2D contacts

conductor section (mm²)	conductor slot Ø A (mm)	conductors stripping length (mm)
0,14-0,37	0,9	7,5
0,5	1,1	7,5
0,75	1,3	7,5
1,0	1,45	7,5
1,5	1,8	7,5
2,5	2,2	7,5
3	2,55	7,5
4	2,85	7,5

CX20 poles connector inserts
Maximum current load derating diagram



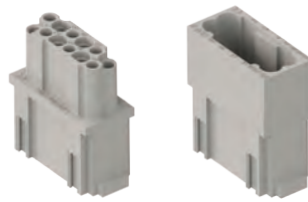
The modular inserts must be installed in suitable frames, which are then mounted in traditional enclosures* or in COB panel supports.

frames for modular units*

page: 333

* enclosures: bulkhead mounting housings, high construction housings or high construction hoods

modular units, crimp connections



RATING 250V

Q 10.000 MATINGS WITH HNM FRAMES AND HNM ENCLOSURES

Q 5.000 MATINGS WITH HNM FRAMES AND STANDARD ENCLOSURES, SINGLE LEVER

10A crimp contacts gold plated



description

part No.

part No

without contacts (to be ordered separately)
female inserts for female contacts
male inserts for male contacts

CX 12 DF
CX 12 DM

10A female contacts

0,14-0,37 mm ²	AWG 26-22	identification No. 1
0,5 mm ²	AWG 20	identification No. 2
0,75 mm ²	AWG 18	identification No. ②
1 mm ²	AWG 18	identification No. 3
1,5 mm ²	AWG 16	identification No. 4
2,5 mm ²	AWG 14	identification No. 5

gold plated

RDF2D 0.3
RDF2D 0.5
RDF2D 0.7
RDF2D 1.0
RDF2D 1.5
RDF2D 2.5

10A male contacts

0,14-0,37 mm ²	AWG 26-22	identification No. 1
0,5 mm ²	AWG 20	identification No. 2
0,75 mm ²	AWG 18	identification No. ②
1 mm ²	AWG 18	identification No. 3
1,5 mm ²	AWG 16	identification No. 4
2,5 mm ²	AWG 14	identification No. 5

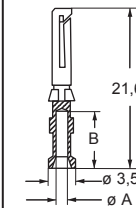
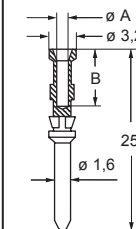
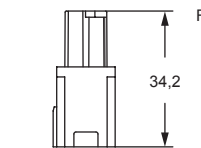
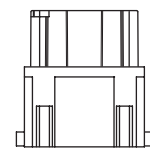
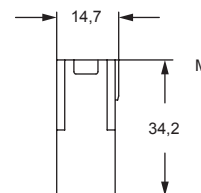
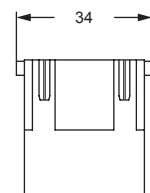
gold plated

RDM2D 0.3
RDM2D 0.5
RDM2D 0.7
RDM2D 1.0
RDM2D 1.5
RDM2D 2.5

- characteristics according to EN 61984:

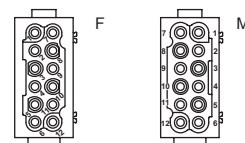
10A 250V 4kV 3

- certified
- rated voltage according to UL/CSA: 600V
- insulation resistance: ≥ 10 GΩ
- ambient temperature limit: -40 °C ... +125 °C
- made of self-extinguishing thermoplastic resin UL 94V-0
- mechanical life: ≥ 10.000 cycles
- contact resistance: ≤ 3 mΩ
- PCBs interface, refer to article CIF 2.4 on page 670
- **it is recommended to crimp the contacts with crimping tools homologated by ILME** (please see the crimping tool section 10A contacts, RDF2D and RDM2D series) on pages 708 - 741
- for max. current load see the connector inserts derating diagram below; for more information see page 28



contacts side (front view)

side with reference arrow ▲

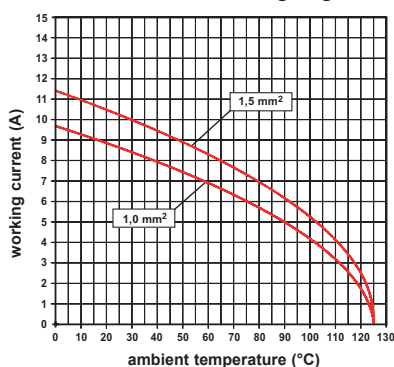


- 1 frame slot

RDF2D and RDM2D contacts

conductor section mm ²	conductor slot ϕA (mm)	conductors stripping length B (mm)
0,14-0,37	0,9	8
0,5	1,1	8
0,75	1,3	8
1,0	1,45	8
1,5	1,8	8
2,5	2,2	6

CX 12 poles connector inserts
Maximum current load derating diagram



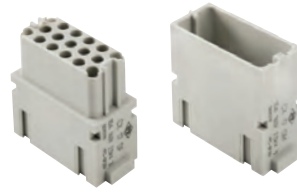


The modular inserts must be installed in suitable frames, which are then mounted in traditional enclosures or in COB panel supports.

frames for modular units

page: 333

modular units, crimp connections



Q 10.000 MATINGS WITH HNM FRAMES AND HNM ENCLOSURES

Q 5.000 MATINGS WITH HNM FRAMES AND STANDARD ENCLOSURES, SINGLE LEVER

10A crimp contacts, gold plated



description	part No.	part No.
-------------	----------	----------

without contacts (to be ordered separately)
female inserts for female contacts
male inserts for male contacts

CX 17 DF
CX 17 DM

10A female contacts

area	AWG	identification No.
0,14-0,37 mm ²	AWG 26-22	identification No. 1
0,5 mm ²	AWG 20	identification No. 2
0,75 mm ²	AWG 18	identification No. ②
1 mm ²	AWG 18	identification No. 3
1,5 mm ²	AWG 16	identification No. 4
2,5 mm ²	AWG 14	identification No. 5

RDF2D 0.3
RDF2D 0.5
RDF2D 0.7
RDF2D 1.0
RDF2D 1.5
RDF2D 2.5

gold plated

10A male contacts

area	AWG	identification No.
0,14-0,37 mm ²	AWG 26-22	identification No. 1
0,5 mm ²	AWG 20	identification No. 2
0,75 mm ²	AWG 18	identification No. ②
1 mm ²	AWG 18	identification No. 3
1,5 mm ²	AWG 16	identification No. 4
2,5 mm ²	AWG 14	identification No. 5

RDM2D 0.3
RDM2D 0.5
RDM2D 0.7
RDM2D 1.0
RDM2D 1.5
RDM2D 2.5

- characteristics according to EN 61984:

10A 160V 2,5kV 3
10A 250V 4kV 2

- cULus (UL for USA and Canada), SP, ccc, DNV-GL

- BUREAU VERITAS EAC certified

- rated voltage according to UL/CSA: 250V

- insulation resistance: ≥ 10 GΩ

- ambient temperature limit: -40 °C ... +125 °C

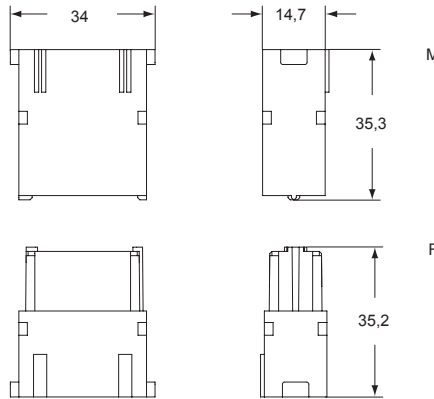
- made of self-extinguishing thermoplastic resin UL 94V-0

- mechanical life: ≥ 10.000 cycles

- contact resistance: ≤ 3 mΩ

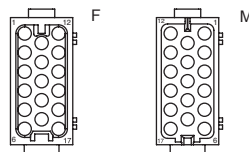
- it is recommended to crimp the contacts with crimping tools homologated by ILME (please see the crimping tool section 10A contacts, RDF2D and RDM2D series) on pages 708 - 741

- for max. current load see the connector inserts derating diagram below; for more information see page 28

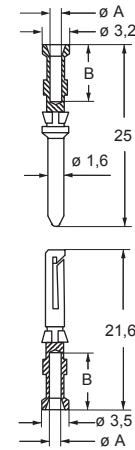


contacts side (front view)

side with reference arrow ▲



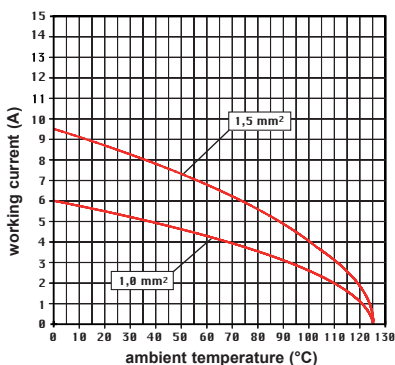
- 1 frame slot



RDF2D and RDM2D contacts

conductor section	conductor slot	conductors stripping length
mm ²	ø A (mm)	B (mm)
0,14-0,37	0,9	8
0,5	1,1	8
0,75	1,3	8
1,0	1,45	8
1,5	1,8	8
2,5	2,2	6

CX 17 poles connector inserts
Maximum current load derating diagram



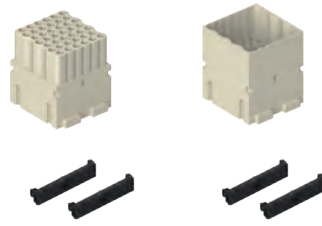
The modular inserts must be installed in suitable frames, which are then mounted in traditional enclosures* or in COB panel supports.

frames for modular units*

page: 333

* enclosures: bulkhead mounting housings, high construction housings or high construction hoods

modular units, crimp connections



Q 10.000 MATINGS WITH HNM FRAMES AND HNM ENCLOSURES

Q 5.000 MATINGS WITH HNM FRAMES AND STANDARD ENCLOSURES, SINGLE LEVER

10A crimp contacts gold plated



description

part No.

part No.

without contacts (to be ordered separately), supplied with 2 dedicated black coloured 2-slot sized lock-in tab female inserts for female contacts male inserts for male contacts

CX 42 DF
CX 42 DM

10A female contacts

0,14-0,37 mm ²	AWG 26-22	identification No. 1
0,5 mm ²	AWG 20	identification No. 2
0,75 mm ²	AWG 18	identification No. ②
1 mm ²	AWG 18	identification No. 3
1,5 mm ²	AWG 16	identification No. 4
2,5 mm ²	AWG 14	identification No. 5

gold plated

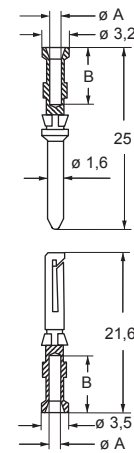
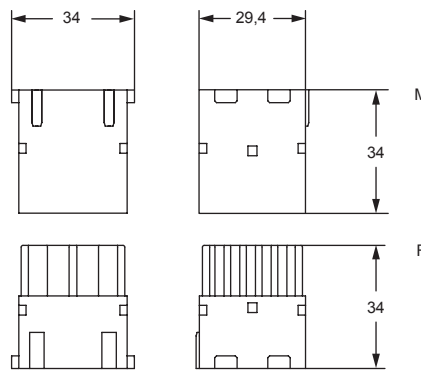
RDF2D 0.3
RDF2D 0.5
RDF2D 0.7
RDF2D 1.0
RDF2D 1.5
RDF2D 2.5

10A male contacts

0,14-0,37 mm ²	AWG 26-22	identification No. 1
0,5 mm ²	AWG 20	identification No. 2
0,75 mm ²	AWG 18	identification No. ②
1 mm ²	AWG 18	identification No. 3
1,5 mm ²	AWG 16	identification No. 4
2,5 mm ²	AWG 14	identification No. 5

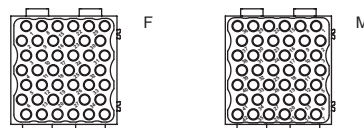
RDM2D 0.3
RDM2D 0.5
RDM2D 0.7
RDM2D 1.0
RDM2D 1.5
RDM2D 2.5

- characteristics according to EN 61984:
- 10A 150V 2,5kV 3**
- cULus (UL for USA and Canada) certified, CSA, CQC, DNV-GL, BV, EAC pending
- rated voltage according to UL/CSA: 250V
- insulation resistance: $\geq 10 \text{ G}\Omega$
- ambient temperature limit: -40 °C ... +125 °C
- made of self-extinguishing thermoplastic resin UL 94V-0
- mechanical life: ≥ 10.000 cycles
- contact resistance: $\leq 3 \text{ m}\Omega$
- supplied with dedicated black coloured 2-slot sized lock-in tab (2, one per each side).
- for spare lock-in tab **CX CFMD** see SPARE SPARTS catalogue
- **it is recommended to crimp the contacts with crimping tools homologated by ILME** (please see the crimping tool section 10A contacts, RDF2D and RDM2D series) on pages 708 - 741
- for max. current load see the connector inserts derating diagram below; for more information see page 28



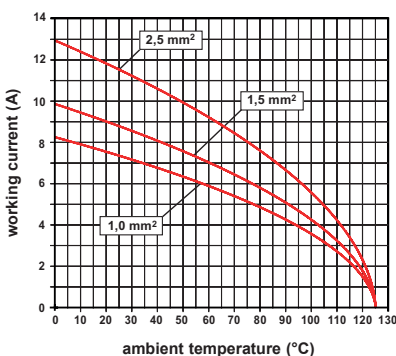
contacts side (front view)

rear view, side with reference arrow ▲



- 2 frame slots

CX 42 D, 42 poles connector inserts
Maximum current load derating diagram



RDF2D and RDM2D contacts

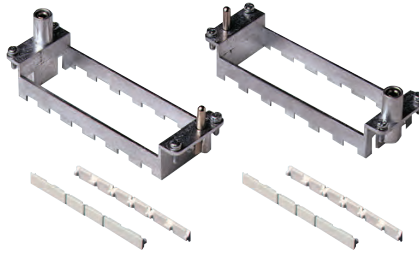
conductor cross-sectional area mm ²	conductor slot ø A (mm)	conductor stripping length B (mm)
0,14-0,37	0,9	8
0,5	1,1	8
0,75	1,3	8
1,0	1,45	8
1,5	1,8	8
2,5	2,2	6



enclosures size:		page:
"44.27"	HNM	592 - 593
	C-TYPE IP65 or IP66/IP69, single lever	387 - 392
	V-TYPE IP65 or IP66/IP69, single lever	444 - 447
	E-Xtreme® corrosion proof	530 - 531
		542, 550 - 551
"57.27"	HNM	594 - 595
	C-TYPE IP65 or IP66/IP69, single lever	393 - 401
	V-TYPE IP65 or IP66/IP69, single lever	448 - 453
	E-Xtreme® corrosion proof	532 - 533
		543, 552 - 553
"77.27"	HNM	596 - 597
	C-TYPE IP65 or IP66/IP69, single lever	402 - 411
	V-TYPE IP65 or IP66/IP69, single lever	454 - 458
	E-Xtreme® corrosion proof	534 - 535
		544, 554 - 555
"104.27"	HNM	598 - 599
	C-TYPE IP65 or IP66/IP69, single lever	412 - 423
	V-TYPE IP65 or IP66/IP69, single lever	459 - 463
	E-Xtreme® corrosion proof	536 - 537
		545, 556 - 557
"77.62"	C-TYPE IP65 or IP66/IP69, single lever	424 - 429
	E-Xtreme® corrosion proof	546
"104.62"	C-TYPE IP65 or IP66/IP69, single lever	430
	E-Xtreme® corrosion proof	547

C-TYPE and V-TYPE 2-lever versions cannot be used to reach 5.000 matings.

frames for modular units with lock-in tab (included)



- Q 10.000 MATINGS WITH HNM FRAMES AND HNM ENCLOSURES
- Q 5.000 MATINGS WITH HNM FRAMES AND STANDARD ENCLOSURES, SINGLE LEVER

description	part No.	part No.
-------------	----------	----------

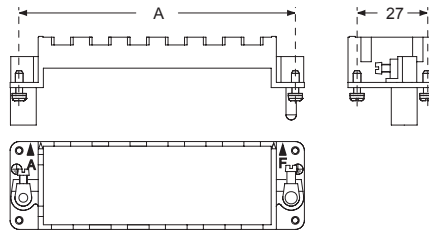
frames for modular units with lock-in tab included
 for 2 modular units - for housing size 44.27
 for 3 modular units - for housing size 57.27
 for 4 modular units - for housing size 77.27 and 77.62
 for 6 modular units - for housing size 104.27 and 104.62

type for hoods*	type for housings*
RX 02 TM	RX 02 TF
RX 03 TM	RX 03 TF
RX 04 TM	RX 04 TF
RX 06 TM	RX 06 TF

- die-cast zinc alloy frames
- protective earth (PE)
- possibility of mounting female and male modular units on the same frame
- frames supplied with lock-in tab to attach units
- polarisation on frames
- coding pins **CR..CX**
- for spare lock-in tab **CX CFM** see SPARE SPARTS catalogue

* Assignment of attribute "for hoods" or "for housings" is merely conventional: both types can be mounted either in a hood or in a housing. In a modular connector coupling there shall be always a frame type "M" and a frame type "F".

RX TM / TF



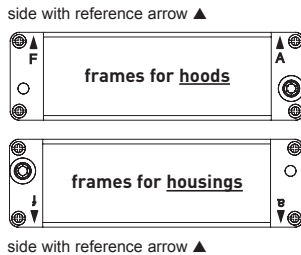
part No.	A (mm)	for housings size
RX 02 TM / TF	44	44.27
RX 03 TM / TF	57	57.27
RX 04 TM / TF	77,5	77.27 and 77.62
RX 06 TM / TF	104	104.27 and 104.62

Earth terminal

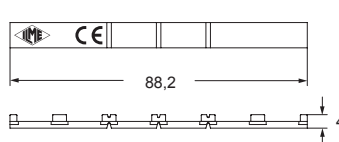
- large: for cables from 4-6 mm², AWG 12-10
- small: for cables from 1-2,5 mm², AWG 18-14

In order to accommodate larger PE conductor cross-sectional area, use CGT PE adapters, see page 319.

position of modules (contact side view)

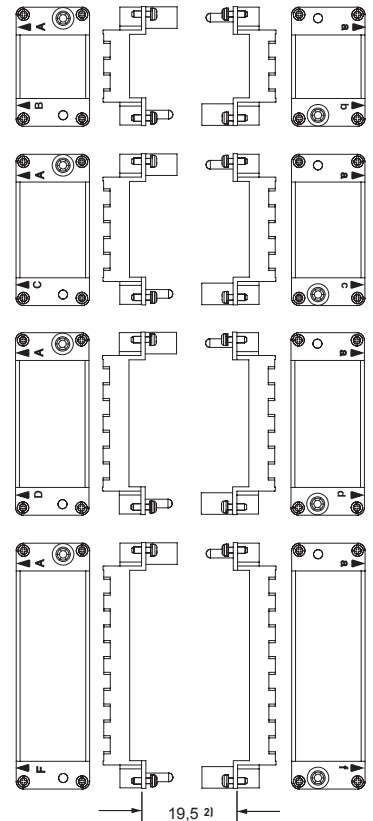


CX CFM (lock-in tab)



Polarisation of frames with relative identification letters and couplings

frame for hoods¹⁾ frames for housings¹⁾



1) Warning:

- The module support frames are marked:
- FOR HOODS: **upper-case A-B, A-C, A-D and A-F**
- FOR HOUSINGS: **lower-case a-b, a-c, a-d and a-f**

Positioning the modules in the frames according to the respective letters is ensuring the specular assembly of modules, for which the hood will be coupled correctly to the housing.

2) Distance for:

- electric and fibre optic contacts: max 21 mm
- pneumatic contacts: max 20,5 mm

MIXO - HNM

ENCLOSURES



CK - MK
 • Size 21.21339 - 343

CKX
 • Size 21.21344 - 345

CK - CKG - MKG *DESINA*
 • Size 21.21346 - 348

CKA - MKA
 • Size 21.21349 - 352

CKA - MKA *DESINA*
 • Size 21.21353 - 354

MKAG *DESINA*
 • Size 21.21355

CKAX
 • Size 21.21356

CKA - CKAXX
 • Size 21.21357

MKAX
 • Size 21.21358, 360, 362

MKA - MKAXX
 • Size 21.21359, 361, 363



CQ - MQ
 • Size 32.13365 - 367



MIXO ONE CXA - MXA
 • Pages.....368 - 371



IL-BRID CZ - MZ
 • Size 49.16374 - 377, 382
 • Size 66.16378 -382



RIGID LEVER CZ7 - MZ7
 • Size 49.16384
 • Size 66.16385



C-TYPE

• Size 44.27	387 - 392
• Size 57.27	393 - 401
• Size 77.27	402 - 411
• Size 104.27	412 - 423
• Size 77.62	424 - 429
• Size 104.62	430
• Size 66.40	431 - 434



V-TYPE IP67 V-TYPE IP65/IP66

• Size 44.27	436 - 437 (IP67), 444 - 447 (IP65/IP66)
• Size 57.27	438 (IP67), 448 - 453 (IP65/IP66)
• Size 77.27	439 - 440 (IP67), 454 - 458 (IP65/IP66)
• Size 104.27	441 - 442 (IP67), 459 - 463 (IP65/IP66)



BIG

• Size 44.27	466 - 467
• Size 57.27	468 - 469
• Size 77.27	470 - 471
• Size 104.27	472 - 473



T-TYPE T-TYPE/W

• Size 44.27	480 - 481, 489 (W)
• Size 57.27	482 - 483, 490 (W)
• Size 77.27	484 - 485, 491 (W)
• Size 104.27	486 - 487, 492 (W)



HYGIENIC T-TYPE/H

• Size 44.27	501
• Size 57.27	502
• Size 77.27	503
• Size 104.27	504

HYGIENIC T-TYPE/C

• Size 44.27	506
• Size 57.27	507
• Size 77.27	508
• Size 104.27	509



W-TYPE

• Size 21.21	512 - 518
• Size 49.16	519
• Size 66.16	520
• Size 44.27	521
• Size 57.27	522
• Size 77.27	523
• Size 104.27	524
• Size 77.62	525
• Size 104.62	526
• Size 66.40	527



E-Xtreme® IP67 V-TYPE lever / standard

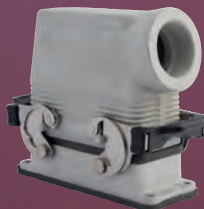
- Size 44.27 530
- Size 57.27 532
- Size 77.27 534
- Size 104.27 536

E-Xtreme® for aggressive environments

- Size 21.21 538 - 539
- Size 49.16 540
- Size 66.16 541
- Size 44.27 531, 542
- Size 57.27 533, 543
- Size 77.27 535, 544
- Size 104.27 537, 545
- Size 77.62 546
- Size 104.62 547
- Size 66.40 548

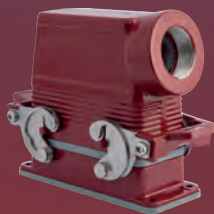
E-Xtreme® IP68

- Size 44.27 550 - 551
- Size 57.27 552 - 553
- Size 77.27 554 - 555
- Size 104.27 556 - 557



EMC

- Size 21.21 564 - 572
- Size 32.13 573 - 575
- Size 49.16 576
- Size 66.16 577
- Size 44.27 578
- Size 57.27 579
- Size 77.27 580
- Size 104.27 581



180 °C

- Size 21.21 583 - 585
- Size 44.27 586
- Size 57.27 587
- Size 77.27 588
- Size 104.27 589
- Size 104.62 590



HNM

- Size 44.27 592 - 593
- Size 57.27 594 - 595
- Size 77.27 596 - 597
- Size 104.27 598 - 599
- Dummy hoods, self-centring floating frame 600 - 601



CENTRAL LEVER

- Size 44.27603 - 605
- Size 57.27606 - 608
- Size 77.27609 - 611
- Size 104.27612 - 614
- Locking device..... 615



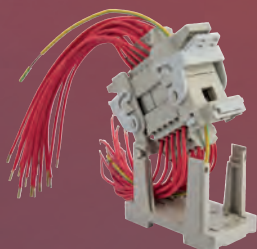
LS-TYPE

- Size 44.27618 - 619
- Size 57.27620 - 621
- Size 77.27622 - 623
- Size 104.27624 - 625



IP68

- Size 21.21628 - 631
- Size 44.27632 - 635
- Size 57.27636 - 639
- Size 77.27640 - 643
- Size 104.27644 - 647



COB

- For inserts size 44.27652 - 653
- For inserts size 57.27652 - 653
- For inserts size 77.27652 - 653
- For inserts size 104.27652 - 653
- For inserts size 49.16654
- For inserts size 66.16654

SPECIAL ENCLOSURES



CVI/MVI angled bulkhead mounting (Motor connection)

- Size 57.27 450



CH bulkhead

- Size 44.27 656
- Size 57.27 656
- Size 77.27 656
- Size 104.27 656



CA bottom entry

- Size 104.27 657



CYR cable passing hoods 658

CYG for in-line joints 659



T-BOX branch couplings660 - 661

Thermoplastic and metallic enclosures size "21.21" for standard or aggressive environments

SUM-UP

- ☒ For use with all size "21.21" connector
- ☒ Thanks to the inner coding key differently shaped between metallic enclosures (trapezoidal cross-section) and insulating enclosures (rectangular cross-section inscribed in the trapeze), connector inserts size "21.21" having a floating PE contact (e.g. CDF/M 07) while for use at voltages higher than SELV (safety extra-low voltage) are prevented to fit into metallic enclosures CKA-MKA, CGK-MGK, as they would not provide the required PE connection to the enclosure. The corresponding outer coding keyway of all "21.21" inserts having the PE contact able to guarantee bonding to earth to the metallic enclosure or of those inserts deemed to be used only at SELV is similarly trapezoidal, thus these inserts fit into all enclosures. Insulating "21.21" enclosures accept all "21.21" inserts.
- ☒ CGK-MGK IP68 enclosures (currently IP66/IP68/IP69 reali) available both with 2-screw locking or by 2-bayonet locking (types with suffix B)



- ✓ UL certified for USA and Canada for Type 4, 4X and 12 degrees of protection (enclosure type ratings, equivalent to NEMA rating), printed on the packaging. IP44 degree of protection, IP66/IP67/IP69 by using the special fixing screw + gasket kit **CKR 65(D)** separately available, and suitable cable outlet device. IP66/IP68/IP69 degree of protection for CGK-MGK enclosures equipped with **CKR 65(D)** kit.

✎ Characteristics of materials for CK and MK series

- Insulating enclosures in self-extinguishing light grey RAL 7035 or jet black RAL 9005 thermoplastic material;
- metal enclosures in die cast zinc or aluminium alloy, according to model;
- metal enclosures with epoxy-polyester thermosetting powder coating grey RAL 7040;
- gaskets in anti-aging, oil-resistant, grease-resistant and fuel-resistant NBR vinyl nitrile elastomer provided on the "21.21" male inserts (according to model), glued on some hood models and some cover models, or provided as flange gasket (according to model);
- metallic enclosures with block locking lever in stainless or galvanized steel;
- insulating enclosures with single-block locking lever in self-extinguishing thermoplastic material (CK-MK) or with stainless steel lever (CKX- MKX).

CK - MK standard insulating version

inserts		page:
CK	3 poles + ⊕	58
CK	4 poles + ⊕	58
CKS	3 poles + ⊕	-
CKS	4 poles + ⊕	-
CKSH	3 poles + ⊕	63
CKSH	4 poles + ⊕	63
CD	7 poles + ⊕	66
CD	8 poles	67
CQ4	2 poles + ⊕	182
CQ4 H	2 poles + ⊕	183
CQ4	3 poles + ⊕	184
CQ	5 poles + ⊕	186
CQ	7 poles + ⊕	187
CQ	12 poles + ⊕	189
CQ	21 poles	190

only for I (straight) housings (if the counterpart has glued gasket):

CJ KF	223
CJK 8FT	226
CJK 8IFT	226, 228
CUK 2FT	236
CUK 3FT	236
CLK 04 SC	239
CX 1/2 BD	243
CXL 2/4 SF, CXL 2/4 SM	250
CXL SF, CXL SM	250

bulkhead mounting housings



angled bulkhead mounting housings



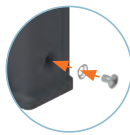
description	part No.	part No. (entry Pg 11)	part No. (entry M20)
with lever	CK 03 I (light grey RAL 7035)		
with lever	CK 03 IN (jet black RAL 9005)		
without cable entry, with lever 1)		CK 03 IA (light grey RAL 7035)	
without cable entry, with lever 1)		CK 03 IAN (jet black RAL 9005)	
with cable entry and lever 1)		CK 03 IAPS (light grey RAL 7035)	MK IAP20 (light grey RAL 7035)
with cable entry and lever 1)		CK 03 IAPNS (jet black RAL 9005)	MK IAPN20 (jet black RAL 9005)
gasket and screw kit for IP66/IP67/IP69 2)	CKR 65	CKR 65	
gasket and screw kit for IP66/IP67/IP69 2) specific for CD 07/08 inserts	CKR 65 D	CKR 65 D	

1) Not suitable for CQ4 series inserts

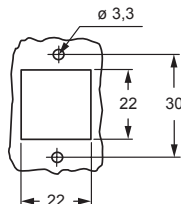
2) To obtain the IP66/IP67/IP69 degree of protection it is necessary to replace the fixing screw supplied with all inserts, with the one with gasket included in the kit (to be purchased separately) **except for** the inserts listed below (already supplied with a fixing screw with gasket):

- CQF/M 07, CQF/M 12
- CJ KF
- CJK 8FT /8IFT
- CUK 2FT /3FT
- CX 1/2 BDF/M
- CLK 04 SCF /SCF-H /SCM
- CXL 2/4 SF /SM, CXL SF/M

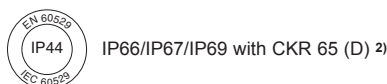
NOTE: The enclosure shown here is an example. The screw and sealing gasket kit can be used with all enclosures' part nos. in this page



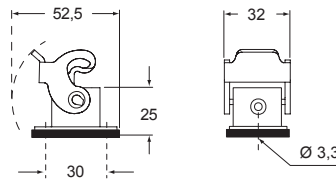
panel cut-out for enclosures



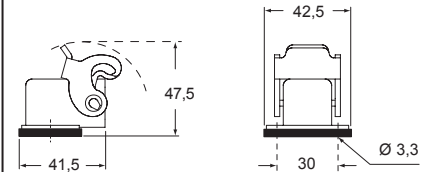
CAIUS Type 12
Type 4/4X only
with CKR 65 (D)



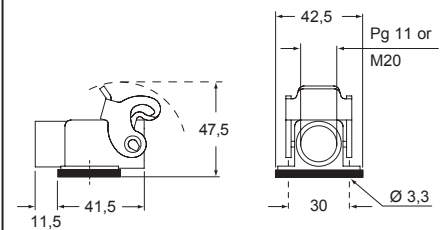
CK I - CK IN



CK IA - CK IAN



CK IAPS - CK IAPSN and MK IAP - MK IAPN



CK - MK

CK - MK standard insulating version

inserts		page:
CK	3 poles + ⊕	58
CK	4 poles + ⊕	58
CKS	3 poles + ⊕	-
CKS	4 poles + ⊕	-
CKSH	3 poles + ⊕	63
CKSH	4 poles + ⊕	63
CD	7 poles + ⊕	66
CD	8 poles	67
CQ4	2 poles + ⊕	182
CQ4 H	2 poles + ⊕	183
CQ4	3 poles + ⊕	184
CQ	5 poles + ⊕	186
CQ	7 poles + ⊕	187
CQ	12 poles + ⊕	189
CQ	21 poles	190

hoods



covers

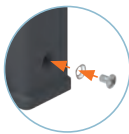


description	part No. (entry Pg 11)	part No. (entry M20)	part No. (with eyelet)	part No. (with loop)
with pegs, top entry 1)	CK 03 VS (light grey RAL 7035)	MK V20 (light grey RAL 7035)		
with pegs, top entry 1)	CK 03 VNS (jet black RAL 9005)	MK VN20 (jet black RAL 9005)		
with pegs, side entry 1)	CK 03 VAS (light grey RAL 7035)	MK VA20 (light grey RAL 7035)		
with pegs, side entry 1)	CK 03 VANS (jet black RAL 9005)	MK VAN20 (jet black RAL 9005)		
with lever, top entry 1)	CK 03 VGS (light grey RAL 7035)	MK VG20 (light grey RAL 7035)		
with lever, top entry 1)	CK 03 VGNS (jet black RAL 9005)	MK VGN20 (jet black RAL 9005)		
with pegs and gasket, for female inserts			CK 03 C (light grey RAL 7035)	CK 03 CS (light grey RAL 7035)
with pegs and gasket, for female inserts			CK 03 CN (jet black RAL 9005)	CK 03 CNS (jet black RAL 9005)
with pegs, for male inserts			CK 03 CA (light grey RAL 7035)	CK 03 CAS (light grey RAL 7035)
with pegs, for male inserts			CK 03 CAN (jet black RAL 9005)	CK 03 CANS (jet black RAL 9005)
with lever and gasket, for female inserts				CK 03 CX (light grey RAL 7035)
with lever and gasket, for female inserts				CK 03 CXN (jet black RAL 9005)
with lever, for male inserts				CK 03 CXA (light grey RAL 7035)
with lever, for male inserts				CK 03 CXAN (jet black RAL 9005)
gasket and screw kit for IP66/IP67/IP69 2)	CKR 65			
gasket and screw kit for IP66/IP67/IP69 2) specific for CD 07/08 inserts	CKR 65 D			

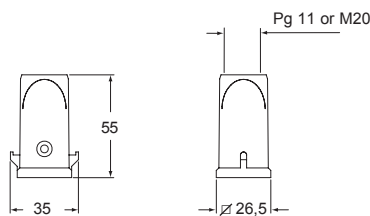
1) Not suitable for CQ4 series inserts

2) To obtain the IP66/IP67/IP69 degree of protection it is necessary to replace the fixing screw supplied with all inserts, with the one with gasket included in the kit (to be purchased separately) **except for** the inserts listed below (already supplied with a fixing screw with gasket):
- CQF/M 07, CQF/M 12

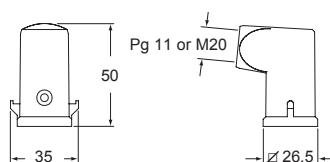
NOTE: The enclosure shown here is an example. The screw and sealing gasket kit can be used with all enclosures' part nos. in this page



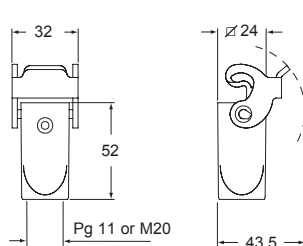
CK VS - CK VNS and MK V - MK VN



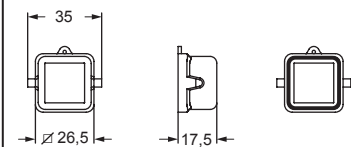
CK VAS - CK VANS and MK VA - MK VAN



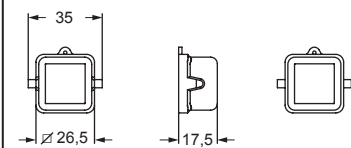
CK VGS - CK VGNS and MK VG - MK VGN



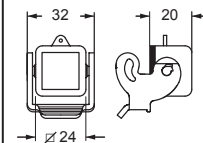
CK C - CK CN - CK CS



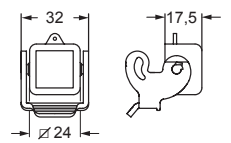
CK CA - CK CAN - CK CAS



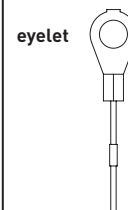
CK CX - CK CXN



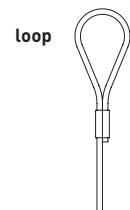
CK CXA - CK CXAN



For fixing on housings



For fixing on hoods



CAIUS Type 12
Type 4/4X only
with CKR 65 (D)



IP66/IP67/IP69 with CKR 65 (D) 2)

MK standard insulating version

inserts		page:
CK	3 poles + ⊕	58
CK	4 poles + ⊕	58
CKS	3 poles + ⊕	-
CKS	4 poles + ⊕	-
CKSH	3 poles + ⊕	63
CKSH	4 poles + ⊕	63
CD	7 poles + ⊕	66
CD	8 poles	67
CQ4	2 poles + ⊕	182
CQ4 H	2 poles + ⊕	183
CQ4	3 poles + ⊕	184
CQ	5 poles + ⊕	186
CQ	7 poles + ⊕	187
CQ	12 poles + ⊕	189
CQ	21 poles	190

hood



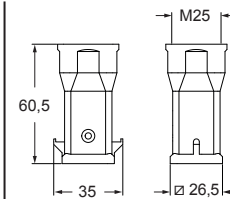
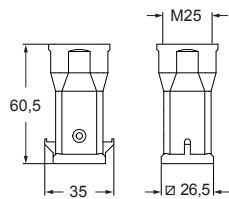
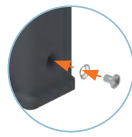
hood



description	part No. (entry M25)	part No. (entry M25)
with pegs, top entry	MK V25 (light grey RAL 7035)	MK VN25 (jet black RAL 9005)
with pegs, top entry		
gasket and screw kit for IP66/IP67/IP69 1)	CKR 65	CKR 65
gasket and screw kit for IP66/IP67/IP69 1) specific for CD 07/08 inserts	CKR 65 D	CKR 65 D

1) To obtain the IP66/IP67/IP69 degree of protection it is necessary to replace the fixing screw supplied with all inserts, with the one with gasket included in the kit (to be purchased separately) **except for** the inserts listed below (already supplied with a fixing screw with gasket):
- CQF/M 07, CQF/M 12

NOTE: The enclosure shown here is an example. The screw and sealing gasket kit can be used with all enclosures' part nos. in this page



CAIUS® Type 12
Type 4/4X only
with CKR 65 (D)



IP66/IP67/IP69 with CKR 65 (D) 1)

MK standard insulating version

inserts	page:
CK 3 and 4 poles + ⊕	58
CKS 3 and 4 poles + ⊕	-
CKSH 3 and 4 poles + ⊕	63
CD 7 poles + ⊕	66
CD 8 poles	67
CQ4 2 poles + ⊕	182
CQ4 H 2 poles + ⊕	183
CQ4 3 poles + ⊕	184
CQ 5 poles + ⊕	186
CQ 7 poles + ⊕	187
CQ 12 poles + ⊕	189
CQ 21 poles	190
CLK 04 SC	239
CX 1/2 BD	243
CXL 2/4 PF, CXL 2/4 PFH	251
CXL 2/4 PM, CXL 2/4 PMH	251
CXL PF, CXL PM	251

hood**description**

part No.
(entry M25)

with lever, top entry

MK VG25 (light grey RAL 7035)

gasket and screw kit
for IP66/IP67/IP69 1)

CKR 65

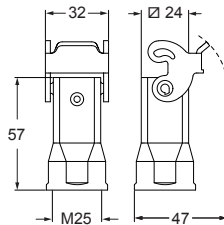
gasket and screw kit for IP66/IP67/IP69 1)
specific for CD 07/08 inserts

CKR 65 D

1) To obtain the IP66/IP67/IP69 degree of protection it is necessary to replace the fixing screw supplied with all inserts, with the one with gasket included in the kit (to be purchased separately) **except for** the inserts listed below (already supplied with a fixing screw with gasket):

- CQF/M 07, CQF/M 12
- CX 1/2 BDF/M
- CLK 04 SCF /SCF-H /SCM
- CXL 2/4 PF /PM /PFH /PMH, CXL PF/PM

NOTE: The enclosure shown here is an example. The screw and sealing gasket kit can be used with all enclosures' part nos. in this page



CAIUS[®]

Type 12
Type 4/4X only
with CKR 65 (D)



IP66/IP67/IP69 with CKR 65 (D) 1)

MK standard insulating version

inserts	page:
CK 3 and 4 poles + ⊕	58
CKS 3 and 4 poles + ⊕	-
CKSH 3 and 4 poles + ⊕	63
CD 7 poles + ⊕	66
CD 8 poles	67
CQ4 2 poles + ⊕	182
CQ4 H 2 poles + ⊕	183
CQ4 3 poles + ⊕	184
CQ 5 poles + ⊕	186
CQ 7 poles + ⊕	187
CQ 12 poles + ⊕	189
CQ 21 poles	190
CLK 04 SC	239
CX 1/2 BD	243
CXL 2/4 PF, CXL 2/4 PFH	251
CXL 2/4 PM, CXL 2/4 PMH	251
CXL PF, CXL PM	251

hood

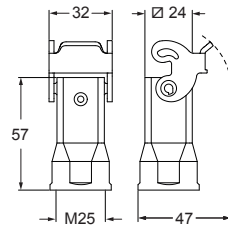
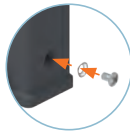


description	part No. (entry M25)
with lever, top entry	MK VGN25 (jet black RAL 9005)
gasket and screw kit for IP66/IP67/IP69 1)	CKR 65
gasket and screw kit for IP66/IP67/IP69 1) specific for CD 07/08 inserts	CKR 65 D

1) To obtain the IP66/IP67/IP69 degree of protection it is necessary to replace the fixing screw supplied with all inserts, with the one with gasket included in the kit (to be purchased separately) **except for** the inserts listed below (already supplied with a fixing screw with gasket):

- CQF/M 07, CQF/M 12
- CX 1/2 BDF/M
- CLK 04 SCF /SCF-H /SCM
- CXL 2/4 PF /PM /PFH /PMH, CXL PF/PM

NOTE: The enclosure shown here is an example. The screw and sealing gasket kit can be used with all enclosures' part nos. in this page



CAIUS®
Type 12
Type 4/4X only
with CKR 65 (D)



IP44 IP66/IP67/IP69 with CKR 65 (D) 1)

CKX standard insulating version

inserts		page:
CK	3 poles + ⊕	58
CK	4 poles + ⊕	58
CKS	3 poles + ⊕	-
CKS	4 poles + ⊕	-
CKSH	3 poles + ⊕	63
CKSH	4 poles + ⊕	63
CD	7 poles + ⊕	66
CD	8 poles	67
CQ4	2 poles + ⊕	182
CQ4 H	2 poles + ⊕	183
CQ4	3 poles + ⊕	184
CQ	5 poles + ⊕	186
CQ	7 poles + ⊕	187
CQ	12 poles + ⊕	189
CQ	21 poles	190

only for I (straight) housings (if the counterpart has glued gasket):

CJ KF		223
CJK 8FT		226
CJK 8IFT	226, 228	
CUK 2FT		236
CUK 3FT		236
CLK 04 SC		239
CX 1/2 BD		243
CXL 2/4 SF, CXL 2/4 SM		250
CXL SF, CXL SM		250

bulkhead mounting housings



angled bulkhead mounting housings



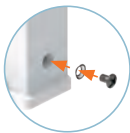
description	part No.	part No. (entry Pg 11)
with stainless steel lever	CKX 03 I (light grey RAL 7035)	
with stainless steel lever	CKX 03 IN (jet black RAL 9005)	
without cable entry, with stainless steel lever 1)		CKX 03 IA
with cable entry and stainless steel lever, with cable gland 1)		CKX 03 IAP
with cable entry and stainless steel lever, without cable gland 1)		CKX 03 IAPS
gasket and screw kit for IP66/IP67/IP69 2)	CKR 65	CKR 65
gasket and screw kit for IP66/IP67/IP69 2) specific for CD 07/08 inserts	CKR 65 D	CKR 65 D

1) Not suitable for CQ4 series inserts

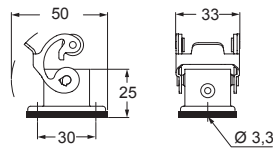
2) To obtain the IP66/IP67/IP69 degree of protection it is necessary to replace the fixing screw supplied with all inserts, with the one with gasket included in the kit (to be purchased separately) **except for** the inserts listed below (already supplied with a fixing screw with gasket):

- CQF/M 07, CQF/M 12
- CJ KF
- CJK 8FT /8IFT
- CUK 2FT /3FT
- CX 1/2 BDF/M
- CLK 04 SCF /SCF-H /SCM
- CXL 2/4 SF /SM, CXL SF/M

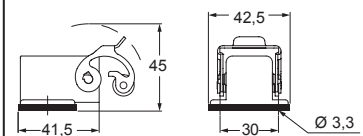
NOTE: The enclosure shown here is an example. The screw and sealing gasket kit can be used with all enclosures' part nos. in this page



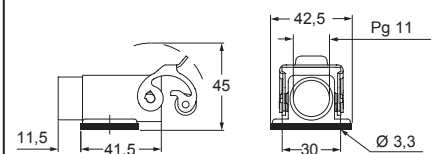
CKX I - CKX IN



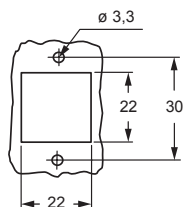
CKX IA



CKX IAP - CKX IAPS



panel cut-out for enclosures



CAUS® Type 12
Type 4/4X only
with CKR 65 (D)



IP66/IP67/IP69 with CKR 65 (D) 2)

CKX standard insulating version

inserts		page:
CK	3 poles + ⊕	58
CK	4 poles + ⊕	58
CKS	3 poles + ⊕	-
CKS	4 poles + ⊕	-
CKSH	3 poles + ⊕	63
CKSH	4 poles + ⊕	63
CD	7 poles + ⊕	66
CD	8 poles	67
CQ	5 poles + ⊕	186
CQ	7 poles + ⊕	187
CQ	12 poles + ⊕	189
CQ	21 poles	190

hoods



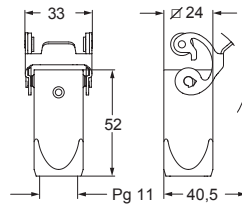
description	part No. (entry Pg 11)
with stainless steel lever, top entry with cable gland	CKX 03 VG
with stainless steel lever, top entry without cable gland	CKX 03 VGS
gasket and screw kit for IP66/IP67/IP69 1)	CKR 65
gasket and screw kit for IP66/IP67/IP69 1) specific for CD 07/08 inserts	CKR 65 D

1) To obtain the IP66/IP67/IP69 degree of protection it is necessary to replace the fixing screw supplied with all inserts, with the one with gasket included in the kit (to be purchased separately) **except for** the inserts listed below (already supplied with a fixing screw with gasket):
- CQF/M 07, CQF/M 12

NOTE: The enclosure shown here is an example. The screw and sealing gasket kit can be used with all enclosures' part nos. in this page



CKX VG - CKX VGS



CAVUS[®] Type 12
Type 4/4X only
with CKR 65 (D)



IP44 IP66/IP67/IP69 with CKR 65 (D) 1)

CK standard insulating version DESINA® ▲

inserts	page:
CJ KF	223
CJK 8FT	226
CJK 8IFT	228
CUK 2FT	236
CUK 3FT	236
CLK 04 SC	239
CX 1/2 BD	243
CXL 2/4 SF	250
CXL 2/4 SM	250
CXL SF	250
CXL SM	250

bulkhead mounting housings



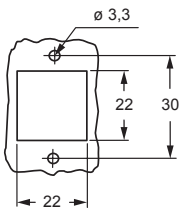
cover



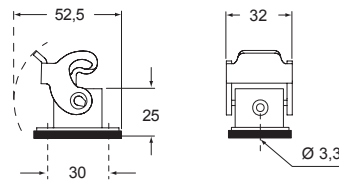
description	part No.	part No.
with lever	CK 03 I (light grey RAL 7035)	
with lever	CK 03 IN (jet black RAL 9005)	
with pegs and glued gasket		CKG 03 C (light grey RAL 7035)
with pegs and glued gasket		CKG 03 CN (jet black RAL 9005)

▲ suitable for DESINA® CXL inserts and CJ, CUK, CLK, CX BD adapters for male inserts without gasket

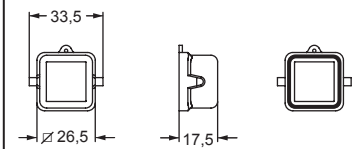
panel cut-out for enclosures



CK I - CK IN



CKG C - CKG CN



CRUS® Type 4/4X/12



CKG - MKG standard insulating version with glued gasket DESINA®

inserts	page:
CJ KM	223
CJK 8MT	226
CJK 8IMT *	226, 228
CUK 2FT	236
CUK 3FT	236
CLK 04 SC *	239
CX 1/2 BD	243
CXL 2/4 PF	251
CXL 2/4 PFH	251
CXL 2/4 PM	251
CXL 2/4 PMH	251
CXL PF	251
CXL PM	251

* cannot be used with angled enclosures
(part No. CKG 03 VA / MKG VA20)

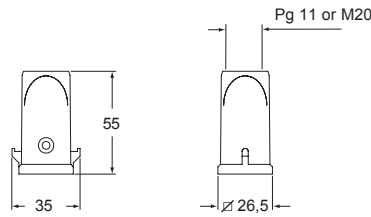
hoods with glued gasket



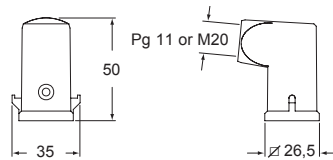
description	part No. (entry Pg 11)	part No. (entry M20)
with pegs and glued gasket, top entry	CKG 03 V (light grey RAL 7035)	MKG V20 (light grey RAL 7035)
with pegs and glued gasket, side entry	CKG 03 VA (light grey RAL 7035)	MKG VA20 (light grey RAL 7035)
with pegs and glued gasket, top entry	CKG 03 VN (jet black RAL 9005)	MKG VN20 (jet black RAL 9005)
with pegs and glued gasket, side entry	CKG 03 VAN (jet black RAL 9005)	MKG VAN20 (jet black RAL 9005)

▲ suitable for DESINA® CXL inserts and CJ, CUK, CLK, CX BD adapters for male inserts without gasket

CKG V - CKG VN and MKG V - MKG VN



CKG VA - CKG VAN and MKG VA - MKG VAN



Type 4/4X/12



inserts	page:
CJ KM	223
CJK 8MT	226
CJK 8IMT	226, 228
CJK 8M	233
CUK 2FT	236
CUK 3FT	236
CLK 04 SC	239
CX 1/2 BD	243
CXL 2/4 PF	251
CXL 2/4 PFH	251
CXL 2/4 PM	251
CXL 2/4 PMH	251
CXL PF	251
CXL PM	251

hood with glued gasket



hood with glued gasket



description

part No.
(entry M25)

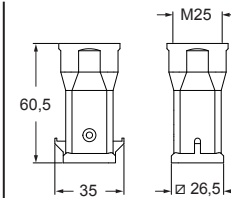
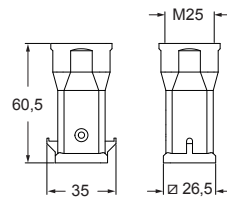
part No.
(entry M25)

with pegs and glued gasket, top entry
with pegs and glued gasket, top entry

MKG V25 (light grey RAL 7035)

MKG VN25 (jet black RAL 9005)

▲ suitable for DESINA® CXL inserts and CJ, CUK, CLK, CX BD adapters for male inserts without gasket



MKG DESINA®

CAUS® Type 4/4X/12



CKA - MKA standard metallic version

inserts		page:
CK	3 poles + ⊕	58
CK	4 poles + ⊕	58
CKS	3 poles + ⊕	-
CKS	4 poles + ⊕	-
CKSH	3 poles + ⊕	63
CKSH	4 poles + ⊕	63
CD	8 poles	67
CQ4	2 poles + ⊕	182
CQ4 H	2 poles + ⊕	183
CQ4	3 poles + ⊕	184
CQ	5 poles + ⊕	186
CQ	7 poles + ⊕	187
CQ	12 poles + ⊕	189
CQ	21 poles	190

only for I (straight) housings (if the counterpart has glued gasket):

CJ KF	223
CJK 8FT	226
CJK 8IFT	226, 228
CUK 2FT	236
CUK 3FT	236
CLK 04 SC	239
CX 1/2 BD	243
CXL 2/4 SF, CXL 2/4 SM	250
CXL SF, CXL SM	250

bulkhead mounting housings



angled bulkhead mounting housings



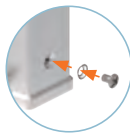
description	part No.	part No. (entry Pg 11)	part No. (entry M20)
with galvanized steel lever	CKA 03 I		
with stainless steel lever	CKAX 03 I		
without cable entry, galvanized steel lever 1)		CKA 03 IA	
without cable entry, stainless steel lever 1)		CKAX 03 IA	
with cable entry, galvanized steel lever 1)		CKA 03 IAPS	MKA IAP20
with cable entry, stainless steel lever 1)		CKAX 03 IAPS	MKAX IAP20
with cable entry, galvanized steel lever, bulkhead hole closed 1)		CKA 03 APS	MKA AP20
with cable entry, stainless steel lever, bulkhead hole closed 1)		CKAX 03 APS	MKAX AP20
gasket and screw kit for IP66/IP67/IP69 2)	CKR 65	CKR 65	
gasket and screw kit for IP66/IP67/IP69 2) specific for CD 08 inserts	CKR 65 D	CKR 65 D	

1) Not suitable for CQ4 series inserts

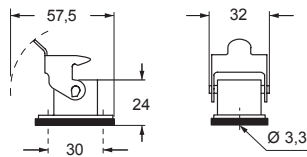
2) To obtain the IP66/IP67/IP69 degree of protection it is necessary to replace the fixing screw supplied with all inserts, with the one with gasket included in the kit (to be purchased separately) **except for** the inserts listed below (already supplied with a fixing screw with gasket):

- CQF/M 07, CQF/M 12
- CJ KF
- CJK 8FT /8IFT
- CUK 2FT /3FT
- CX 1/2 BDF/M
- CLK 04 SCF /SCF-H /SCM
- CXL 2/4 SF /SM, CXL SF/M

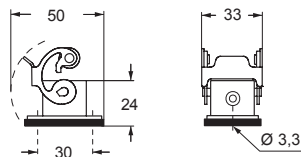
NOTE: The enclosure shown here is an example. The screw and sealing gasket kit can be used with all enclosures' part nos. in this page



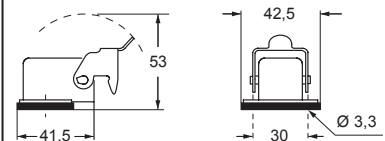
CKA I



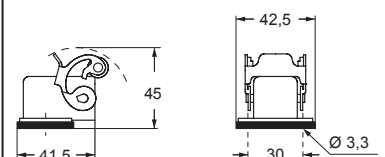
CKAX I



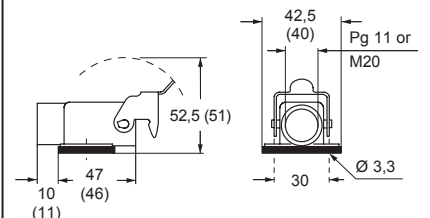
CKA IA



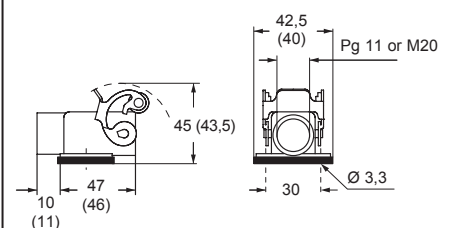
CKAX IA



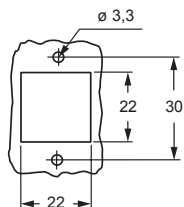
CKA IAPS (CKA APS) and MKA IAP (MKA AP)



CKAX IAPS (CKAX APS) and MKAX IAP (MKAX AP)



panel cut-out for enclosures



Type 12
Type 4/4X only
with CKR 65 (D)



IP66/IP67/IP69 with CKR 65 (D) 2)

inserts		page:
CK	3 poles + ⊕	58
CK	4 poles + ⊕	58
CKS	3 poles + ⊕	-
CKS	4 poles + ⊕	-
CKSH	3 poles + ⊕	63
CKSH	4 poles + ⊕	63
CD	8 poles	67
CQ4	2 poles + ⊕	182
CQ4 H	2 poles + ⊕	183
CQ4	3 poles + ⊕	184
CQ	5 poles + ⊕	186
CQ	7 poles + ⊕	187
CQ	12 poles + ⊕	189
CQ	21 poles	190

angled bulkhead mounting housings



bulkhead mounting housings with SELF-CLOSING cover



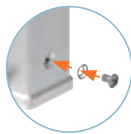
description	part No. (entry M20 / M25)	part No.
galvanized steel lever, M20 fixing thread ^(*) 1) 2)	MKA IAF20	
stainless steel lever, M20 fixing thread ^(*) 1) 2)	MKAX IAF20	
galvanized steel lever, M25 fixing thread ^(*) 1) 2)	MKA IAF25	
stainless steel lever, M25 fixing thread ^(*) 1) 2)	MKAX IAF25	
with galvanized steel lever and gasket, for female inserts		CKA 03 ILS
with galvanized steel lever, for male inserts		CKA 03 ILSA
with stainless steel lever and gasket, for female inserts		CKAX 03 ILS
with stainless steel lever, for male inserts		CKAX 03 ILSA
gasket and screw kit for IP66/IP67/IP69 ²⁾	CKR 65	CKR 65
gasket and screw kit for IP66/IP67/IP69 ²⁾ specific for CD 08 inserts	CKR 65 D	CKR 65 D

(*) Locknut supplied on request, see catalogue cable glands (articles AS M20N and AS M25N metallic, AS M20L and AS M25L insulating)

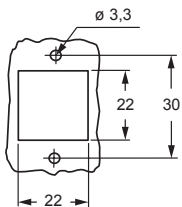
1) Not suitable for CQ4 series inserts

2) To obtain the IP66/IP67/IP69 degree of protection it is necessary to replace the fixing screw supplied with all inserts, with the one with gasket included in the kit (to be purchased separately) **except for** the inserts listed below (already supplied with a fixing screw with gasket):
- CQF/M 07, CQF/M 12

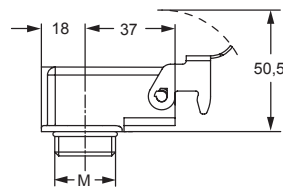
NOTE: The enclosure shown here is an example. The screw and sealing gasket kit can be used with all enclosures' part nos. in this page



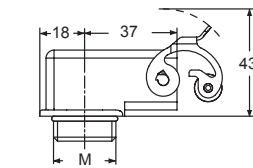
panel cut-out for enclosures CKA ILS/ILSA



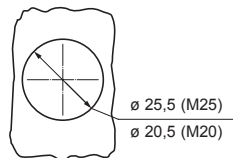
MKA IAF



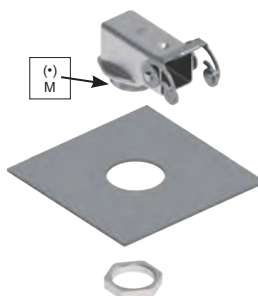
MKAX IAF



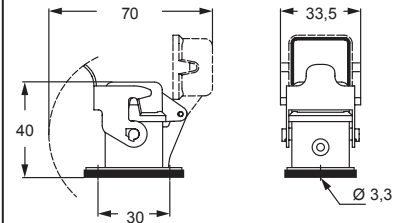
panel cut-out



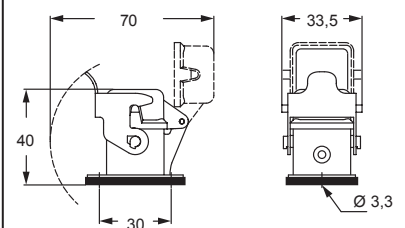
USE OF THE LOCKNUT



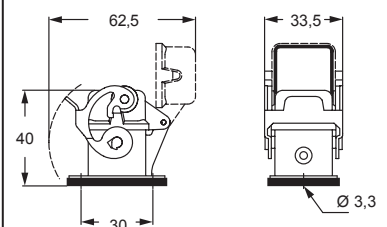
CKA ILS



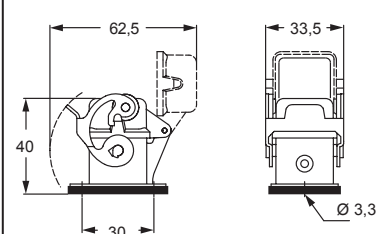
CKA ILSA



CKAX ILS



CKAX ILSA



Type 12
Type 4/4X only
with CKR 65 (D)



IP66/IP67/IP69 with CKR 65 (D) ²⁾

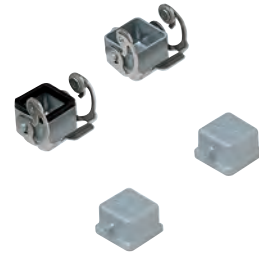
CKA - MKA and CKAX - MKAX standard metallic version

inserts		page:
CK	3 poles + ⊕	58
CK	4 poles + ⊕	58
CKS	3 poles + ⊕	-
CKS	4 poles + ⊕	-
CKSH	3 poles + ⊕	63
CKSH	4 poles + ⊕	63
CD	8 poles	67
CQ4	2 poles + ⊕	182
CQ4 H	2 poles + ⊕	183
CQ4	3 poles + ⊕	184
CQ	5 poles + ⊕	186
CQ	7 poles + ⊕	187
CQ	12 poles + ⊕	189
CQ	21 poles	190

hoods



covers



description	part No. (entry Pg 11)	part No. (entry M20)	part No. (with eyelet)	part No. (with loop)
with pegs, top entry ¹⁾	CKA 03 VS	MKA V20		
angled hoods, with pegs, side entry ¹⁾	CKA 03 VAS	MKA VA20		
with galvanized steel lever, top entry ¹⁾	CKA 03 VGS	MKA VG20		
with stainless steel lever, top entry ¹⁾	CKAX 03 VGS	MKAX VG20		
with pegs and gasket, for female inserts ²⁾			CKA 03 C	CKA 03 CS
with pegs, for male inserts ²⁾			CKA 03 CA	CKA 03 CAS
with stainless steel lever and gasket, for female inserts				CKAX 03 CX
with stainless steel lever, for male inserts				CKAX 03 CXA
gasket and screw kit for IP66/IP67/IP69 ³⁾	CKR 65		CKR 65	
gasket and screw kit for IP66/IP67/IP69 ³⁾ specific for CD 08 inserts	CKR 65 D		CKR 65 D	

¹⁾ Not suitable for CQ4 series inserts

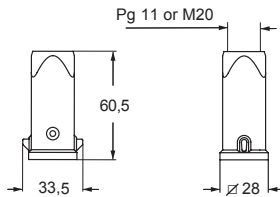
²⁾ Preferably be used with enclosures CKAX (stainless steel lever)

³⁾ To obtain the IP66/IP67/IP69 degree of protection it is necessary to replace the fixing screw supplied with all inserts, with the one with gasket included in the kit (to be purchased separately) **except for** the inserts listed below (already supplied with a fixing screw with gasket):
- CQF/M 07, CQF/M 12

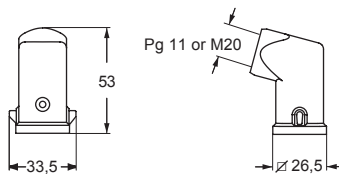
NOTE: The enclosure shown here is an example. The screw and sealing gasket kit can be used with all enclosures' part nos. in this page



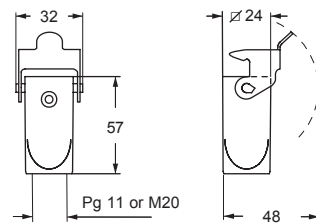
CKA VS and MKA V



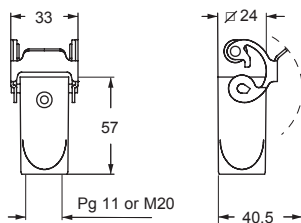
CKA VAS and MKA VA



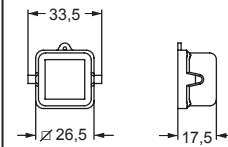
CKA VGS and MKA VG



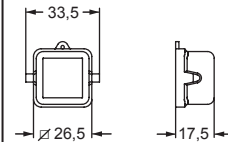
CKAX VGS and MKAX VG



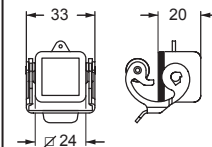
CKA C - CKA CS



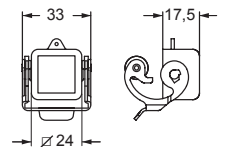
CKA CA - CKA CAS



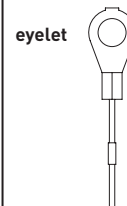
CKAX CX



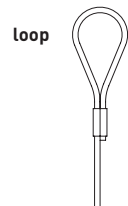
CKAX CXA



For fixing on housings



For fixing on hoods



CEC®
Type 12
Type 4/4X only
with CKR 65 (D)



IP66/IP67/IP69 with CKR 65 (D) ³⁾

MKA standard metallic version

inserts		page:
CK	3 poles + ⊕	58
CK	4 poles + ⊕	58
CKS	3 poles + ⊕	-
CKS	4 poles + ⊕	-
CKSH	3 poles + ⊕	63
CKSH	4 poles + ⊕	63
CD	8 poles	67
CQ4	2 poles + ⊕	182
CQ4 H	2 poles + ⊕	183
CQ4	3 poles + ⊕	184
CQ	5 poles + ⊕	186
CQ	7 poles + ⊕	187
CQ	12 poles + ⊕	189
CQ	21 poles	190

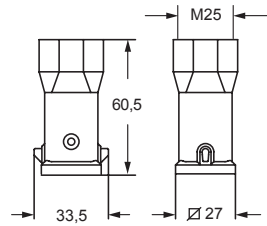
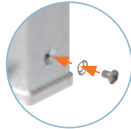
hoods



description	part No. (entry M25)
with pegs, top entry	MKA V25
gasket and screw kit for IP66/IP67/IP69 1)	CKR 65
gasket and screw kit for IP66/IP67/IP69 1) specific for CD 08 inserts	CKR 65 D

1) To obtain the IP66/IP67/IP69 degree of protection it is necessary to replace the fixing screw supplied with all inserts, with the one with gasket included in the kit (to be purchased separately) **except for** the inserts listed below (already supplied with a fixing screw with gasket):
- CQF/M 07, CQF/M 12

NOTE: The enclosure shown here is an example. The screw and sealing gasket kit can be used with all enclosures' part nos. in this page



Type 12
Type 4/4X only
with CKR 65 (D)



IP66/IP67/IP69 with CKR 65 (D) 1)

CKA - CKAX standard metallic version DESINA®

inserts	page:
CJ KF	223
CJK 8FT	226
CJK 8IFT	228
CUK 2FT	236
CUK 3FT	236
CLK 04 SC	239
CX 1/2 BD	243
CXL 2/4 SF	250
CXL 2/4 SM	250
CXL SF	250
CXL SM	250

bulkhead mounting housings cover



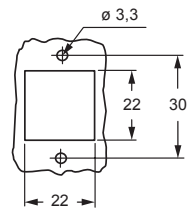
bulkhead mounting housings with SELF-CLOSING cover



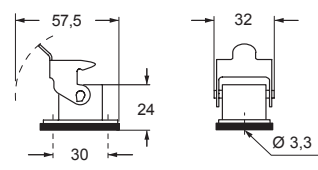
description	part No.	part No.
with galvanized steel lever	CKA 03 I	
with stainless steel lever	CKAX 03 I	
cover with pegs and glued gasket	CKAG 03 C	
with galvanized steel lever and gasket, for female inserts		CKA 03 ILS
with glued gasket on the cover		CKAX 03 ILS
with stainless steel lever and gasket, for female inserts,		
with glued gasket on the cover		

▲ suitable for DESINA® CXL inserts and CJ, CUK, CLK, CX BD adapters for male inserts without gasket

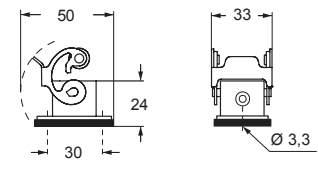
panel cut-out for enclosures



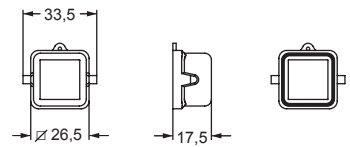
CKA I



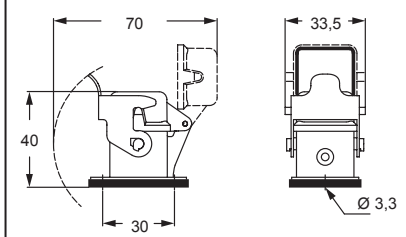
CKAX I



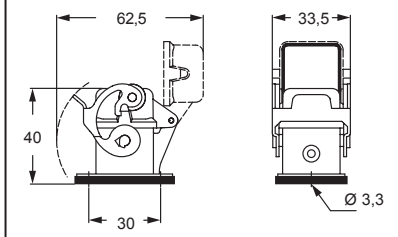
CKAG C



CKA ILS



CKAX ILS



CAIUS Type 4/4X/12

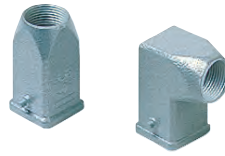


CKA - CKAX DESINA®

inserts	page:
CJ KM	223
CJK 8MT	226
CJK 8IMT *	226, 228
CUK 2FT	236
CUK 3FT	236
CLK 04 SC *	239
CX 1/2 BD	243
CXL 2/4 PF	251
CXL 2/4 PFH	251
CXL 2/4 PM	251
CXL 2/4 PMH	251
CXL PF	251
CXL PM	251

* cannot be used with angled enclosures
(part No. CKAG 03 VA / MKAG VA20)

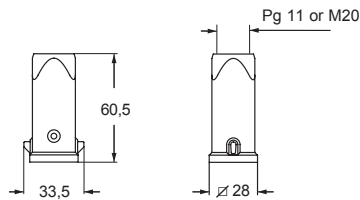
**hoods
with glued gasket**



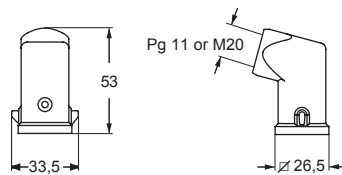
description	part No. (entry Pg 11)	part No. (entry M20)
with pegs and glued gasket, top entry	CKAG 03 V	MKAG V20
with pegs and glued gasket, side entry	CKAG 03 VA	MKAG VA20

▲ suitable for DESINA® CXL inserts and CJ, CUK, CLK, CX BD adapters for male inserts without gasket

CKAG V and MKAG V



CKAG VA and MKAG VA



CAUS® Type 4/4X/12



MKAG standard metallic version with glued gasket DESINA® ▲

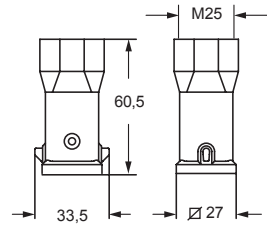
inserts	page:
CJ KM	223
CJK 8MT	226
CJK 8IMT	226, 228
CJK 8M	233
CUK 2FT	236
CUK 3FT	236
CLK 04 SC	239
CX 1/2 BD	243
CXL 2/4 PF	251
CXL 2/4 PFH	251
CXL 2/4 PM	251
CXL 2/4 PMH	251
CXL PF	251
CXL PM	251

**hoods
with glued gasket****description**part No.
(entry M25)

with pegs and glued gasket, top entry

MKAG V25

▲ suitable for DESINA® CXL inserts and CJ, CUK, CLK, CX BD adapters for male inserts without gasket



Type
4/4X/12

CKAX standard metallic version

inserts		page:
CK	3 poles + ⊕	58
CK	4 poles + ⊕	58
CKS	3 poles + ⊕	-
CKS	4 poles + ⊕	-
CKSH	3 poles + ⊕	63
CKSH	4 poles + ⊕	63
CD	8 poles	67
CQ4	2 poles + ⊕	182
CQ4 H	2 poles + ⊕	183
CQ4	3 poles + ⊕	184
CQ	5 poles + ⊕	186
CQ	7 poles + ⊕	187
CQ	12 poles + ⊕	189
CQ	21 poles	190


angled bulkhead mounting housings

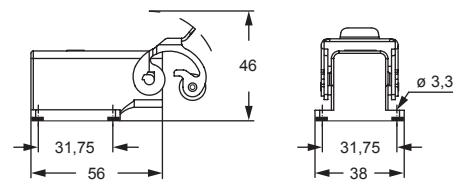
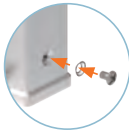


 **STAINLESS STEEL LEVER**

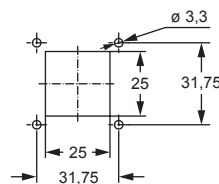
description	part No.
without cable entry, fixing by 4 screws	CKAX 03 IA4
gasket and screw kit for IP66/IP67/IP69 ¹⁾	CKR 65
gasket and screw kit for IP66/IP67/IP69 ¹⁾ specific for CD 08 inserts	CKR 65 D

¹⁾ To obtain the IP66/IP67/IP69 degree of protection it is necessary to replace the fixing screw supplied with all inserts, with the one with gasket included in the kit (to be purchased separately) **except for** the inserts listed below (already supplied with a fixing screw with gasket):
 - CQF/M 07, CQF/M 12

 **NOTE:** The enclosure shown here is an example. The screw and sealing gasket kit can be used with all enclosures' part nos. in this page



panel cut-out for enclosures



CRUS® Type 12
 Type 4/4X only
 with CKR 65 (D)



IP66/IP67/IP69 with CKR 65 (D) ¹⁾

CKA - CKAXX standard metallic version

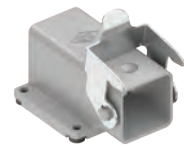
inserts		page:
CK	3 poles + ⊕	58
CK	4 poles + ⊕	58
CKS	3 poles + ⊕	-
CKS	4 poles + ⊕	-
CKSH	3 poles + ⊕	63
CKSH	4 poles + ⊕	63
CD	8 poles	67
CQ4	2 poles + ⊕	182
CQ4 H	2 poles + ⊕	183
CQ4	3 poles + ⊕	184
CQ	5 poles + ⊕	186
CQ	7 poles + ⊕	187
CQ	12 poles + ⊕	189
CQ	21 poles	190

angled bulkhead mounting housings



GALVANIZED STEEL RIGID LEVER

angled bulkhead mounting housings

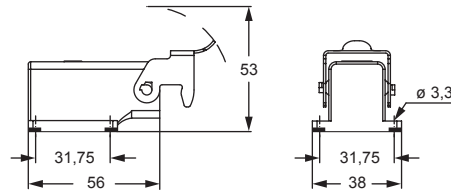
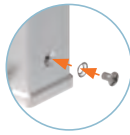


STAINLESS STEEL RIGID LEVER

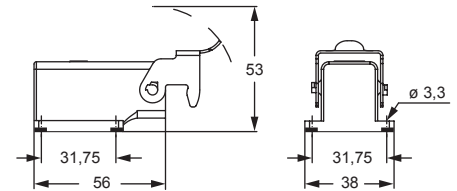
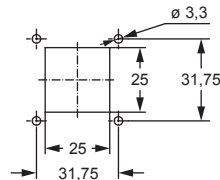
description	part No.	part No.
without cable entry, fixing by 4 screws	CKA 03 IA4	CKAXX 03 IA4
without cable entry, fixing by 4 screws	CKR 65	CKR 65
gasket and screw kit for IP66/IP67/IP69 1)	CKR 65 D	CKR 65 D

1) To obtain the IP66/IP67/IP69 degree of protection it is necessary to replace the fixing screw supplied with all inserts, with the one with gasket included in the kit (to be purchased separately) **except for** the inserts listed below (already supplied with a fixing screw with gasket):
 - CQF/M 07, CQF/M 12

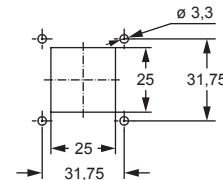
NOTE: The enclosure shown here is an example. The screw and sealing gasket kit can be used with all enclosures' part nos. in this page



panel cut-out for enclosures



panel cut-out for enclosures



CRUS® Type 12
 Type 4/4X only
 with CKR 65 (D)

IP66/IP67/IP69 with CKR 65 (D) 1)

CKA - CKAXX

MKAX standard metallic version

inserts		page:
CK	3 and 4 poles + ⊕	58
CKS	3 and 4 poles + ⊕	-
CKSH	3 and 4 poles + ⊕	63
CD	8 poles	67
CQ4	2 poles + ⊕	182
CQ4 H	2 poles + ⊕	183
CQ4	3 poles + ⊕	184
CQ	5 poles + ⊕	186
CQ	7 poles + ⊕	187
CQ	12 poles + ⊕	189
CQ	21 poles	190

if the counterpart has glued gasket:

CLK 04 SC	239
CX 1/2 BD	243
CXL 2/4 PF/PM	251
CXL 2/4 PFH/PMH	251
CXL PF/PM	251

angled surface mounting housings



STAINLESS STEEL LEVER

angled surface mounting housings



STAINLESS STEEL LEVER

description

part No.
(entry M25)

part No.
(entry M25)

with cable entry, fixing by 4 screws

MKAX IAP25

with cable entry, fixing by 4 screws,
bulkhead hole closed (without gasket)

MKAX AP25

gasket and screw kit
for IP66/IP67/IP69 1)

CKR 65

CKR 65

gasket and screw kit for IP66/IP67/IP69 1)
specific for CD 08 inserts

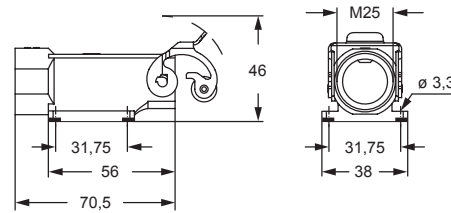
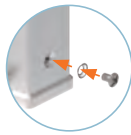
CKR 65 D

CKR 65 D

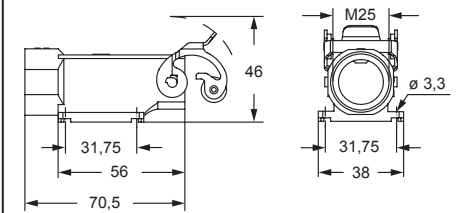
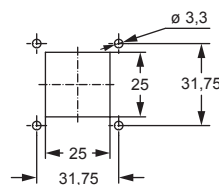
1) To obtain the IP66/IP67/IP69 degree of protection it is necessary to replace the fixing screw supplied with all inserts, with the one with gasket included in the kit (to be purchased separately) **except for** the inserts listed below (already supplied with a fixing screw with gasket):

- CQF/M 07, CQF/M 12
- CX 1/2 BDF/M
- CLK 04 SCF /SCF-H /SCM
- CXL 2/4 PF /PM /PFH /PMH, CXL PF/PM

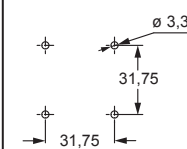
NOTE: The enclosure shown here is an example. The screw and sealing gasket kit can be used with all enclosures' part nos. in this page



panel cut-out for enclosures



panel cut-out for enclosures



Type 12
Type 4/4X only
with CKR 65 (D)



IP66/IP67/IP69 with CKR 65 (D) 1)

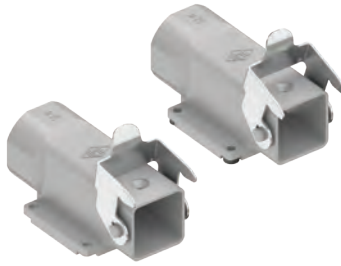
MKA - MKAXX standard metallic version

inserts		page:
CK	3 and 4 poles + ⊕	58
CKS	3 and 4 poles + ⊕	-
CKSH	3 and 4 poles + ⊕	63
CD	8 poles	67
CQ4	2 poles + ⊕	182
CQ4 H	2 poles + ⊕	183
CQ4	3 poles + ⊕	184
CQ	5 poles + ⊕	186
CQ	7 poles + ⊕	187
CQ	12 poles + ⊕	189
CQ	21 poles	190

if the counterpart has glued gasket:

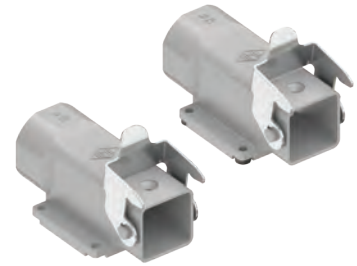
CLK 04 SC	239
CX 1/2 BD	243
CXL 2/4 PF/PM	251
CXL 2/4 PFH/PMH	251
CXL PF/PM	251

angled surface mounting housings



GALVANIZED STEEL RIGID LEVER

angled surface mounting housings



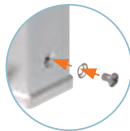
STAINLESS STEEL RIGID LEVER

description	part No. (entry M25)	part No. (entry M25)
with cable entry, fixing by 4 screws	MKA IAP25	
with cable entry, fixing by 4 screws, bulkhead hole closed (without gasket)	MKA AP25	
with cable entry, fixing by 4 screws		MKAXX IAP25
with cable entry, fixing by 4 screws, bulkhead hole closed (without gasket)		MKAXX AP25
gasket and screw kit for IP66/IP67/IP69 1)	CKR 65	CKR 65
gasket and screw kit for IP66/IP67/IP69 1) specific for CD 08 inserts	CKR 65 D	CKR 65 D

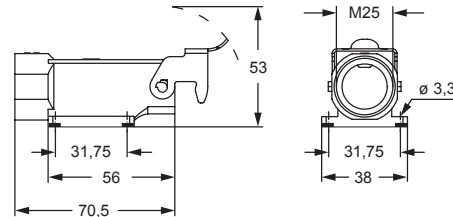
1) To obtain the IP66/IP67/IP69 degree of protection it is necessary to replace the fixing screw supplied with all inserts, with the one with gasket included in the kit (to be purchased separately) **except for** the inserts listed below (already supplied with a fixing screw with gasket):

- CQF/M 07, CQF/M 12
- CX 1/2 BDF/M
- CLK 04 SCF /SCF-H /SCM
- CXL 2/4 PF /PM /PFH /PMH, CXL PF/PM

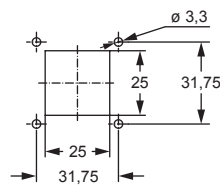
NOTE: The enclosure shown here is an example. The screw and sealing gasket kit can be used with all enclosures' part nos. in this page



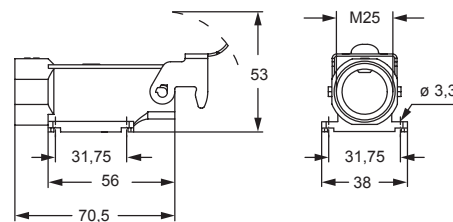
MKA IAP



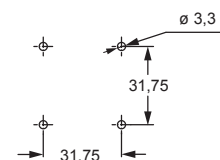
panel cut-out for enclosures



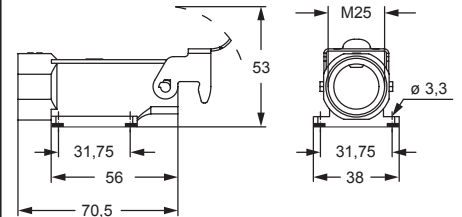
MKA AP



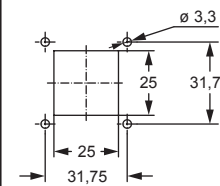
panel cut-out for enclosures



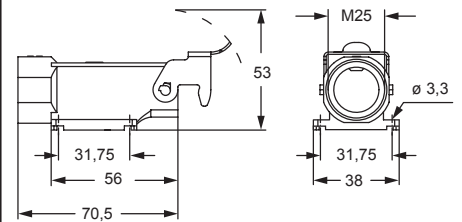
MKAXX IAP



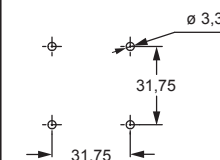
panel cut-out for enclosures



MKAXX AP



panel cut-out for enclosures



Type 12
Type 4/4X only
with CKR 65 (D)



IP66/IP67/IP69 with CKR 65 (D) 1)

MKAX standard metallic version

inserts		page:
CK	3 and 4 poles + ⊕	58
CKS	3 and 4 poles + ⊕	-
CKSH	3 and 4 poles + ⊕	63
CD	8 poles	67
CQ4	2 poles + ⊕	182
CQ4 H	2 poles + ⊕	183
CQ4	3 poles + ⊕	184
CQ	5 poles + ⊕	186
CQ	7 poles + ⊕	187
CQ	12 poles + ⊕	189
CQ	21 poles	190

if the counterpart has glued gasket:

CLK 04 SC	239
CX 1/2 BD	243
CXL 2/4 PF/PM	251
CXL 2/4 PFH/PMH	251
CXL PF/PM	251

hoods




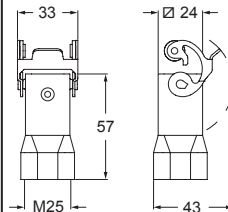
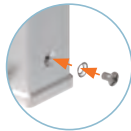
 **STAINLESS STEEL LEVER**

description	part No. (entry M25)
top entry	MKAX VG25
gasket and screw kit for IP66/IP67/IP69 1)	CKR 65
gasket and screw kit for IP66/IP67/IP69 1) specific for CD 08 inserts	CKR 65 D

1) To obtain the IP66/IP67/IP69 degree of protection it is necessary to replace the fixing screw supplied with all inserts, with the one with gasket included in the kit (to be purchased separately) **except for** the inserts listed below (already supplied with a fixing screw with gasket):

- CQF/M 07, CQF/M 12
- CX 1/2 BDF/M
- CLK 04 SCF /SCF-H /SCM
- CXL 2/4 PF /PM /PFH /PMH, CXL PF/PM

 **NOTE:** The enclosure shown here is an example. The screw and sealing gasket kit can be used with all enclosures' part nos. in this page



CRUS® Type 12
Type 4/4X only
with CKR 65 (D)



IP66/IP67/IP69 with CKR 65 (D) 1)

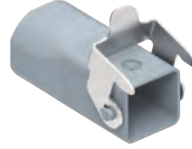
MKA - MKAXX standard metallic version

inserts		page:
CK	3 and 4 poles + ⊕	58
CKS	3 and 4 poles + ⊕	-
CKSH	3 and 4 poles + ⊕	63
CD	8 poles	67
CQ4	2 poles + ⊕	182
CQ4 H	2 poles + ⊕	183
CQ4	3 poles + ⊕	184
CQ	5 poles + ⊕	186
CQ	7 poles + ⊕	187
CQ	12 poles + ⊕	189
CQ	21 poles	190

if the counterpart has glued gasket:

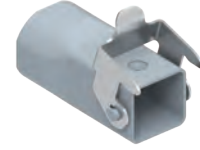
CLK 04 SC	239
CX 1/2 BD	243
CXL 2/4 PF/PM	251
CXL 2/4 PFH/PMH	251
CXL PF/PM	251

hoods



GALVANIZED STEEL RIGID LEVER

hoods



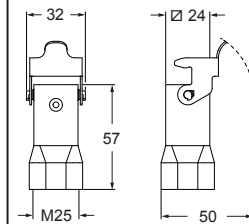
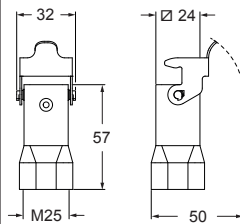
STAINLESS STEEL RIGID LEVER

description	part No. (entry M25)	part No. (entry M25)
top entry	MKA VG25	
top entry		MKAXX VG25
gasket and screw kit for IP66/IP67/IP69 1)	CKR 65	CKR 65
gasket and screw kit for IP66/IP67/IP69 1) specific for CD 08 inserts	CKR 65 D	CKR 65 D

1) To obtain the IP66/IP67/IP69 degree of protection it is necessary to replace the fixing screw supplied with all inserts, with the one with gasket included in the kit (to be purchased separately) **except for** the inserts listed below (already supplied with a fixing screw with gasket):

- CQF/M 07, CQF/M 12
- CX 1/2 BDF/M
- CLK 04 SCF /SCF-H /SCM
- CXL 2/4 PF /PM /PFH /PMH, CXL PF/PM

NOTE: The enclosure shown here is an example. The screw and sealing gasket kit can be used with all enclosures' part nos. in this page



CRUS® Type 12
Type 4/4X only
with CKR 65 (D)



IP66/IP67/IP69 with CKR 65 (D) 1)

MKAX standard metallic version

inserts		page:
CK	3 and 4 poles + ⊕	58
CKS	3 and 4 poles + ⊕	-
CKSH	3 and 4 poles + ⊕	63
CD	8 poles	67
CQ4	2 poles + ⊕	182
CQ4 H	2 poles + ⊕	183
CQ4	3 poles + ⊕	184
CQ	5 poles + ⊕	186
CQ	7 poles + ⊕	187
CQ	12 poles + ⊕	189
CQ	21 poles	190
CJ KF		223
CJK 8FT		226
CJK 8IFT		228
CLK 04 SC		239
CX 1/2 BD		243
CXL 2/4 SF/SM		250
CXL SF/SM		250
CXL 2/4 PF/PM		251
CXL 2/4 PFH/PMH		251
CXL PF/PM		251

bulkhead mounting housings



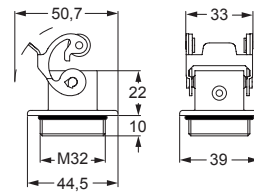
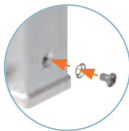
STAINLESS STEEL LEVER

description	part No. (entry M32)
M32 fixing thread ¹⁾ (*)	MKAX IF
gasket and screw kit for IP66/IP67/IP69 ¹⁾	CKR 65
gasket and screw kit for IP66/IP67/IP69 ¹⁾ specific for CD 08 inserts	CKR 65 D

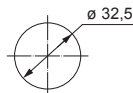
¹⁾ To obtain the IP66/IP67/IP69 degree of protection it is necessary to replace the fixing screw supplied with all inserts, with the one with gasket included in the kit (to be purchased separately) **except for** the inserts listed below (already supplied with a fixing screw with gasket):

- CQF/M 07, CQF/M 12
- CJ KF
- CJK 8FT /8IFT
- CX 1/2 BDF/M
- CLK 04 SCF /SCF-H /SCM
- CXL 2/4 PF /PM /PFH /PMH /SF /SM, CXL SF/M
- CXL PF /PM

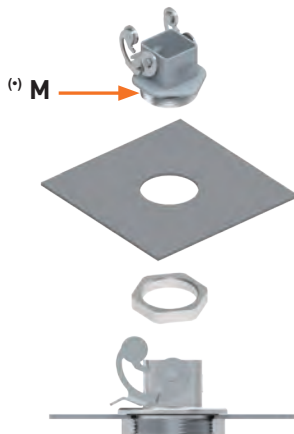
NOTE: The enclosure shown here is an example. The screw and sealing gasket kit can be used with all enclosures' part nos. in this page



panel cut-out for enclosures



^(*) Locknut supplied on request, see Cable glands catalogue (article AS M32N metallic).



CAUS® Type 12
Type 4/4X only
with CKR 65 (D)



IP66/IP67/IP69 with CKR 65 (D) ¹⁾

MKAX

MKA - MKAXX standard metallic version

inserts		page:
CK	3 and 4 poles + ⊕	58
CKS	3 and 4 poles + ⊕	-
CKSH	3 and 4 poles + ⊕	63
CD	8 poles	67
CQ4	2 poles + ⊕	182
CQ4 H	2 poles + ⊕	183
CQ4	3 poles + ⊕	184
CQ	5 poles + ⊕	186
CQ	7 poles + ⊕	187
CQ	12 poles + ⊕	189
CQ	21 poles	190
CJ KF		223
CJK 8FT		226
CJK 8IFT		228
CLK 04 SC		239
CX 1/2 BD		243
CXL 2/4 SF/SM		250
CXL SF/SM		250
CXL 2/4 PF/PM		251
CXL 2/4 PFH/PMH		251
CXL PF/PM		251

bulkhead mounting housings



GALVANIZED STEEL RIGID LEVER

bulkhead mounting housings



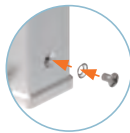
STAINLESS STEEL RIGID LEVER

description	part No. (entry M32)	part No. (entry M32)
M32 fixing thread ¹⁾ (*)	MKA IF	
M32 fixing thread ¹⁾ (*)		MKAXX IF
gasket and screw kit for IP66/IP67/IP69 ¹⁾	CKR 65	CKR 65
gasket and screw kit for IP66/IP67/IP69 ¹⁾ specific for CD 08 inserts	CKR 65 D	CKR 65 D

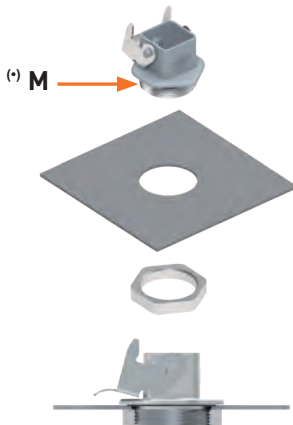
¹⁾ To obtain the IP66/IP67/IP69 degree of protection it is necessary to replace the fixing screw supplied with all inserts, with the one with gasket included in the kit (to be purchased separately) **except for** the inserts listed below (already supplied with a fixing screw with gasket):

- CQF/M 07, CQF/M 12
- CJ KF
- CJK 8FT /8IFT
- CX 1/2 BDF/M
- CLK 04 SCF /SCF-H /SCM
- CXL 2/4 PF /PM /PFH /PMH /SF /SM, CXL SF/M
- CXL PF /PM

NOTE: The enclosure shown here is an example. The screw and sealing gasket kit can be used with all enclosures' part nos. in this page



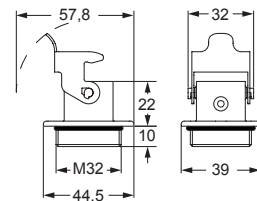
^(*) Locknut supplied on request, see Cable glands catalogue (article AS M32N metallic).



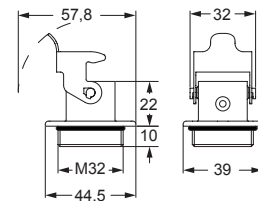
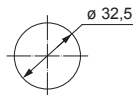
NOTE: Lever colour may vary upon specific part No.

CAVUS® Type 12
Type 4/4X only
with CKR 65 (D)

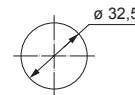
IP44 IP66/IP67/IP69 with CKR 65 (D) ¹⁾



panel cut-out for enclosures



panel cut-out for enclosures



Thermoplastic enclosures size “32.13” standard or EMC versions

SUM-UP

🔖 For use with all size “32.13” connector inserts

🔖 Characteristics of materials for CQ - MQ series

- In self-extinguishing thermoplastic material jet black RAL 9005;
 - gaskets in anti-aging, oil-resistant, grease-resistant and fuel-resistant NBR vinyl nitrile elastomer;
 - with single-block locking lever in self-extinguishing thermoplastic material.
- ✔ UL certified for USA and Canada for Type 4, 4X and 12 degrees of protection (enclosure type ratings, equivalent to NEMA rating), printed on the packaging.

IP66/IP67/IP69 degree of protection.



CQ insulating version

inserts		page:
CQ 04/2	4 poles + 2 poles + ⊕	191
CQ 08	8 poles + ⊕	192
CQ 17	17 poles + ⊕	193

bulkhead mounting housings with single lever

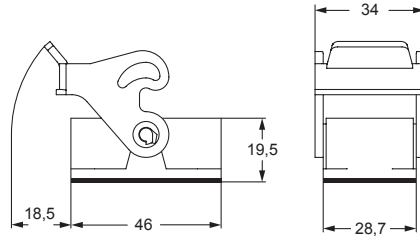


angled bulkhead mounting housings with single lever

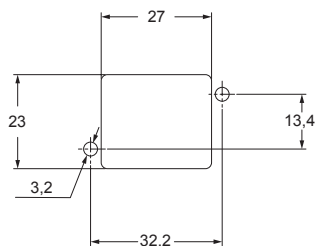


description	part No.	part No.	entry Pg
with lever	CQ 08 I		
without cable entry, with lever		CQ 08 IA	
with cable entry, with lever		CQ 08 IAP	21

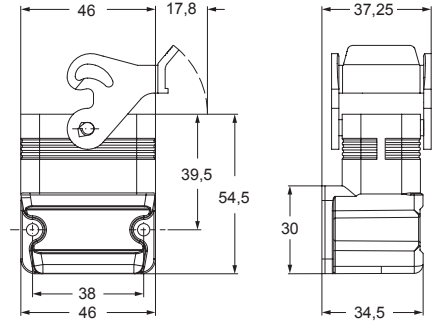
CQ I



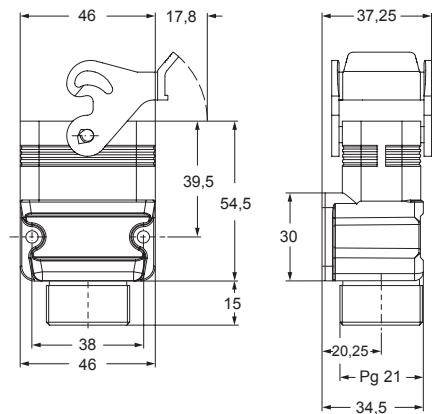
panel cut-out for CQ I enclosure



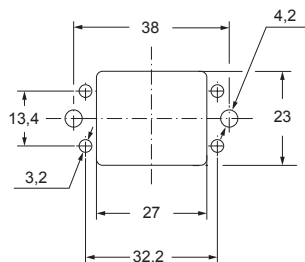
CQ IA



CQ IAP



panel cut-out for CQ IA - CQ IAP enclosure



CALUS Type 4/4X/12



CQ - MQ insulating version

inserts		page:
CQ 04/2	4 poles + 2 poles + ⊕	191
CQ 08	8 poles + ⊕	192
CQ 17	17 poles + ⊕	193

hoods with 2 pegs



hoods with 2 pegs

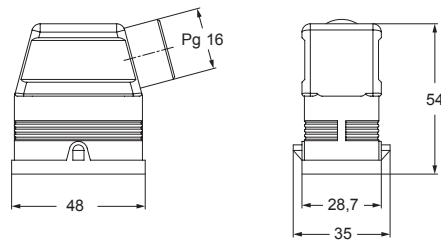


description	part No.	entry Pg	part No.	entry M
with pegs, side entry ¹⁾	CQ 08 VA	16		
with pegs, top entry ¹⁾	CQ 08 V	21		
with pegs, side and top entry ²⁾			MQ 08 VO225	25 x 2

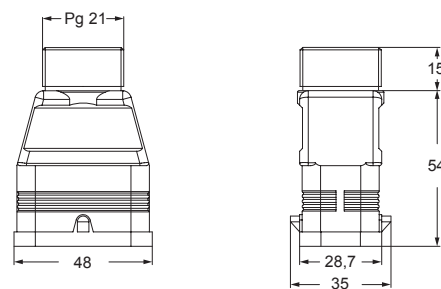
¹⁾ Pg male thread on enclosure exterior

²⁾ metric thread on the internal enclosure;
 accessories to be ordered separately:
 - AL M25DN insulating black sealing plug M25
 - AL M25IN insulating black cable gland M25

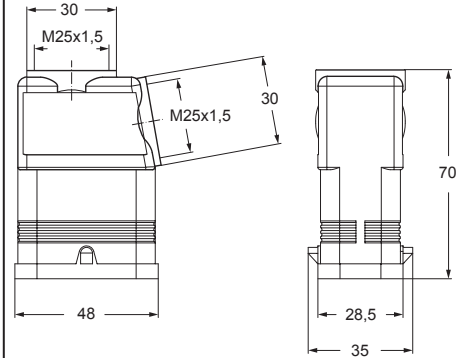
CQ VA



CQ V



MQ VO



CAVUS® Type 4/4X/12
 (pending for MQ 08 VO225)



CQ - MQ

CQ insulating version

inserts		page:
CQ 04/2	4 poles + 2 poles + ⊕	191
CQ 08	8 poles + ⊕	192
CQ 17	17 poles + ⊕	193

hoods with single lever



covers with 2 pegs thermoplastic resin cable glands

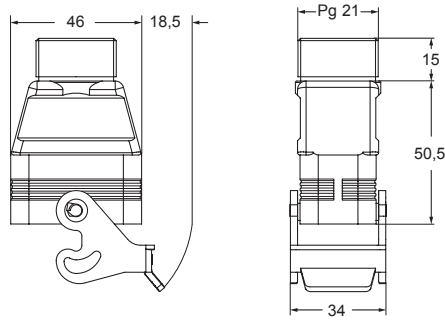


description	part No.	entry Pg	part No.
with lever, top entry ¹⁾	CQ 08 VG	21	
cover with 2 pegs for female inserts			CQ 08 C
cover with 2 pegs for male inserts			CQ 08 CA
cable gland head and gasket for CQ 08 VA enclosure			CRQ 16
cable gland head and gasket for CQ 08 IAP/V/VG enclosure			CRQ 21

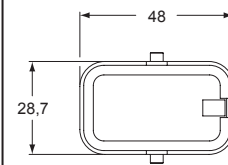
¹⁾ Pg male thread on enclosure exterior

cable diameters for cable glands:
 - **CRQ 16**: 10 - 14,5 mm
 - **CRQ 21**: 14 - 18 mm

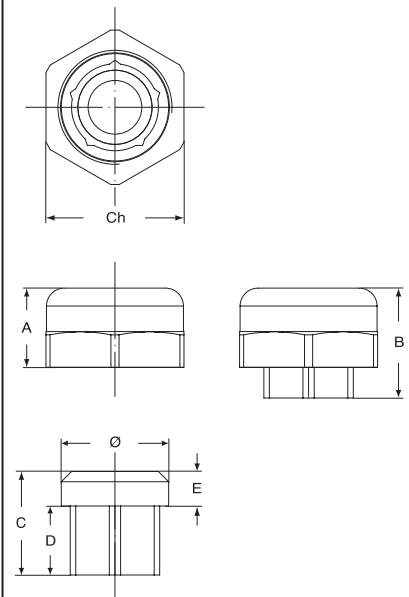
CQ VG



CQ C and CQ CA



CRQ 16 and CRQ 21



part No.	A	B	C	D	E	Ø	Ch
CRQ 16	15,5	21,5	20,25	13,5	6,75	21	27
CRQ 21	18,2	27,5	25	15,5	9	26,5	33

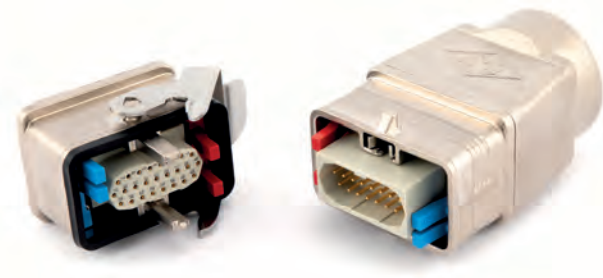
CRUS® Type 4/4X/12



MIXO ONE - CXA - MXA TECHNICAL FEATURES

MIXO ONE is the aluminium housings system designed by ILME to accept the wide range of MIXO series single-sized modules.

- These robust connector enclosures (3 hood variants and 1 bulkhead mounting housing) transform each single MIXO module into a completely independent connector;
- the enclosures allow mounting of single MIXO module only in one guided way, to avoid incorrect match with the mating connector;
- the enclosures incorporate a pre-leading (first-make, last-break) PE connection terminal and contact, for the safest connector operation;
- the pins protruding from the bulkhead mounting housing act also as key guide, in cooperation with the corresponding keyway sockets in the hoods, to avoid incorrect 180° reversed mating with corresponding connector;
- the rigid locking lever is releasably mounted on moulded pegs that include a stopping teeth;
- the hoods are split in two parts (front, rear), to allow MIXO module mounting and simplify the enclosure's PE connection. Supplied with four self-threading screws and self-retaining sealing gasket;
- the bulkhead mounting housing is supplied with the module locking frame and self-retaining flange gasket;
- four optional coding pins available for up to 16 different codings, as a provision against mismatching when identical connectors are installed side by side;
- protection covers for hoods and housings, either with pegs (for enclosures with locking lever and sealing gasket) or with locking lever and sealing gasket (for enclosures with pegs) available either with eyelet-terminated string (for fastening to housings) or with loop-terminated cord (for fastening to hoods, around the incoming cable).



SUM-UP

- ☑ Aluminium die cast alloy, nickel plated
- ☑ Rigid stainless steel locking lever
- ☑ Hoods split in two parts (front, rear), to simplify the PE connection. Supplied with four self-threading screws and sealing gasket
- ☑ Four optional coding pins for up to 16 different codings, as a provision against mismatching when identical connectors are installed side by side
- ☑ Protection covers for hoods and housings made in shock-proof thermoplastic material, either with pegs (for enclosures with locking lever and sealing gasket) or with locking lever and sealing gasket (for enclosures with pegs) both with eyelet-terminated string (for fastening to housings) or with loop-terminated cord (for fastening to hoods, around the incoming cable)



Watch our
MIXO ONE housing
system video

MIXO ONE CXA - MXA

inserts MIXO

insert	quantity	page:
CX 01 G	1 module	264
CX 02 7	1 module	266
CX 02 4	1 module	267
CX 02 4A, CX 02 4B	1 module	268
CX 03 4	1 module	269
CX 03 4B	1 module	270
CX 3/4 XD	1 module	271
CX 04 X	1 module	272
CX 05 S	1 module	-
CX 05 SH	1 module	274
CX 06 C, CX 06P C	1 module	275, 276
CX 08 C	1 module	277
CX 02 CH *)	1 module	279
CX 12 D, CX 17 D	1 module	281, 282
CX 25 IB	1 module	284
CX 25 I	1 module	-
CX 08 I6	1 module	286
CX 01 9V, CX 01 9VT	1 module	296, 298
CX 04 L	1 module	299
CX 04 R	1 module	300
CX 04 SC	1 module	301
CX 01 J8, CX 01 J8I	1 module	302
CX 03 P, CX 02 P	1 module	312

*) can be used only with CXA 01 I and MXA 01 V32 enclosures

bulkhead mounting housing with single lever



hoods with 2 pegs



description	part No.	part No.	entry M
with lever	CXA 01 I		
with pegs, side entry (in 2 parts)		MXA 01 O25	25
with pegs, top entry (in 2 parts)		MXA 01 V25	25
with pegs, top entry (in 2 parts)		MXA 01 V32	32

PE terminal

On both the bulkhead mounting housing and on the hood front part, PE screw terminal without protection plate, zinc plated steel terminal screw with rounded tip.

Connecting capacity:

0,5 mm² (20 AWG) – 10 mm² (8 AWG) both unprepared and prepared stranded copper wire.

PE terminal screw head footprint:

for Ph1 or 1,0x5,5 mm flat screwdriver, recommended torque 1,2 Nm (10.6 lb.in)

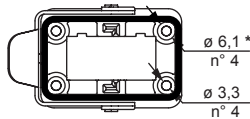
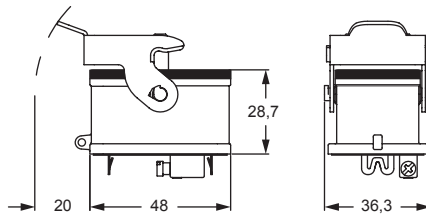
NOTE:

Some regulations may require conductor preparation with a crimped end sleeve.

Recommended crimp shape: square, e.g. by using

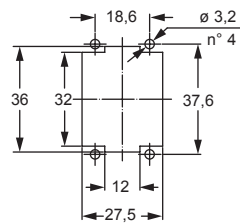
Rennsteig ferrule crimping pliers PEW 8.85 (610 1853).

CXA I

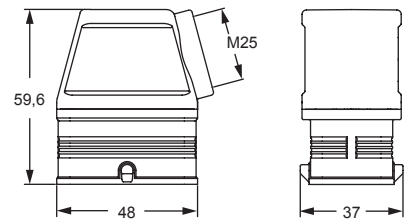


* for M3 fixing screws (not supplied) with maximum 6 mm head diameter

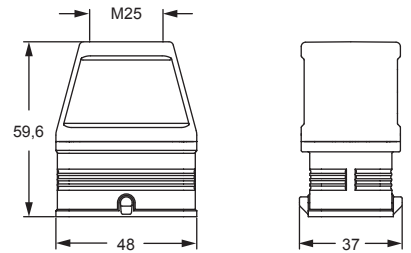
panel cut-out for bulkhead mounting housings



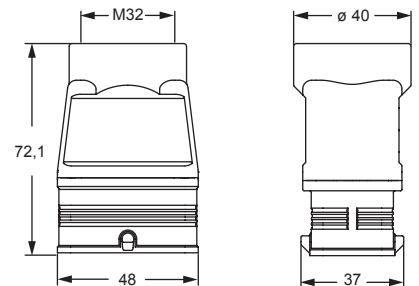
MXA O25



MXA V25



MXA V32

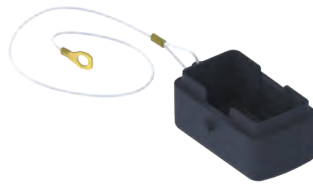


cURus
Type 4/4X/12 pending



according to IEC/EN 60529

plastic covers



plastic covers with lever and gasket



description

part No.
(with eyelet)

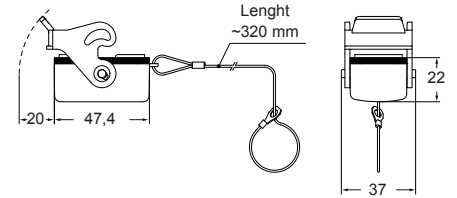
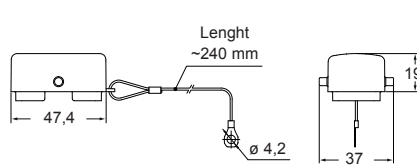
part No.
(with loop)

with 2 pegs (for enclosures with 1 lever with gasket)

CXP 01 C

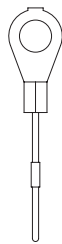
with 1 lever and gasket (for hoods with 2 pegs)

CXP 01 CLG



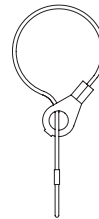
For fixing on housings

eyelet



For fixing on hoods

loop



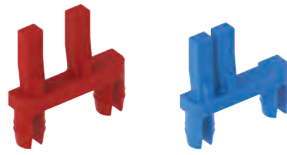
cURus
Type 4/4X/12 pending



according to IEC/EN 60529

MIXO ONE CR CX coding pins

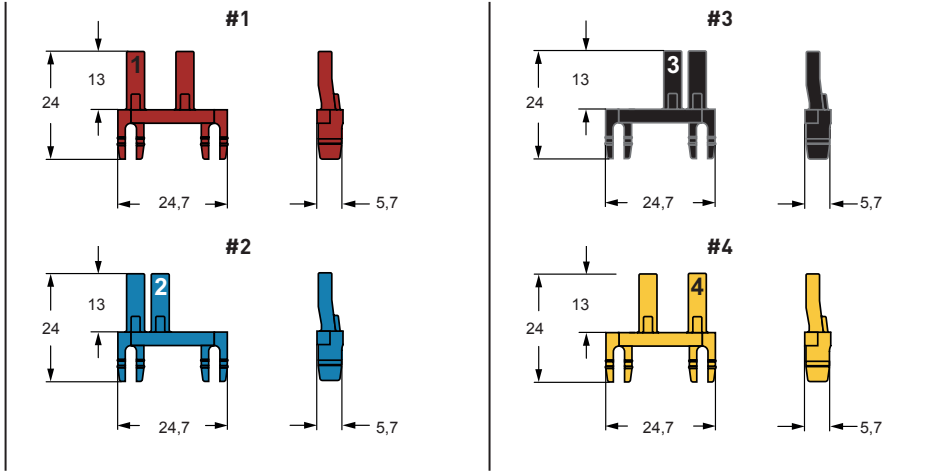
coding pins



coding pins



description	part No.	part No.
red coding pin (#1)	CR CX01R	
blue coding pin (#2)	CR CX01B	
yellow coding pin (#3)		CR CX01G
black coding pin (#4)		CR CX01N



CR CX01 CODING OPTIONS



Example of coding option 6 of 16 different codings possible (4 coding pins per each connector coupling)

MIXO ONE



IL-BRID

IL-BRID

Soft closing, strong hold

Through its original design, the IL-BRID locking lever combines the smoothness of the thermoplastic material with the sturdiness of the stainless steel spring; it has also a linear design which favours a quick wash without retaining external elements.



SUM-UP

- ☑ **Soft closing:** in the first phase, the thermoplastic locking lever component comes into play: sliding the locking lever on the pin reduces friction and wear. It is suitable in all applications with frequent opening and closing
- ☑ **Strong hold:** after the first closing phase involving the plastic component, the stainless steel hook intervenes to guarantee higher resistance to mechanical stress

- ✔ IP66/IP69 degree of protection.
- ✔ IP65 degree of protection versions with hinged cover.

✍ Characteristics of materials for CZ and MZ series

- Made of die cast aluminium alloy;
- with epoxy-polyester powder coating;
- gaskets in anti-aging, oil-resistant, grease-resistant and fuel-resistant vinyl nitrile elastomer;
- locking device with levers and springs in stainless steel;
- lever handles in self-extinguishing thermoplastic material reinforced with glass fibres, UL approved (for CZ and MZ enclosures).

CZ - MZ IL-BRID standard version

inserts

CD	15 poles + ⊕
CDA	10 poles + ⊕
CSAH	10 poles + ⊕
CDC	10 poles + ⊕
MIXO	1 module

page:

68
98
99
104
264 - 316

bulkhead mounting housings with single lever



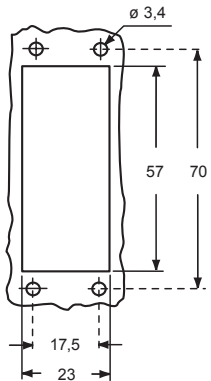
surface mounting housings with single lever



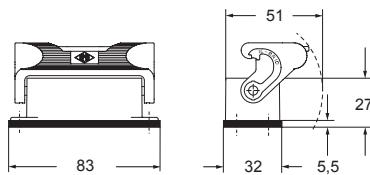
description	part No.	part No.	entry Pg	part No.	entry M
with single lever	CZI 15 L				
with single lever and cover	CZI 15 LS				
with single lever		CZP 15 L	16		
with single lever		CZP 15 L2	16 x 2		
with single lever		CZP 15 L21	21	MZP 15 L25	25
with single lever		CZP 15 L221	21 x 2	MZP 15 L225	25 x 2
with single lever and cover		CZP 15 LS	16		
with single lever and cover		CZP 15 LS2	16 x 2		
with single lever and cover		CZP 15 LS21	21	MZP 15 LS25	25
with single lever and cover		CZP 15 LS221	21 x 2	MZP 15 LS225	25 x 2

☑ The enclosures ensure IP66/IP69 degree of protection (or IP65 for hinged cover versions) when mated and locked with the closing levers.

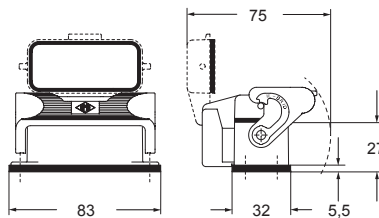
panel cut-out for bulkhead mounting housings



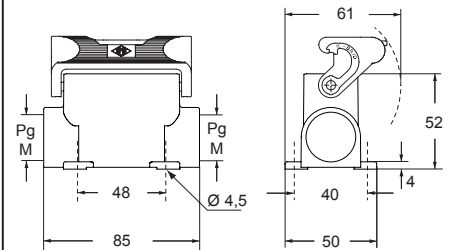
CZI L ▲



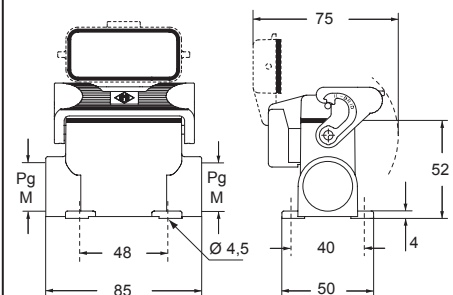
CZI LS ●



CZP L and MZP L ▲



CZP LS and MZP LS ●



CAUS Type 4/4X/12



CZ - MZ IL-BRID lever standard version SIMPLEX self-closing covers

inserts		page:
CD	15 poles + ⊕	68
CDA	10 poles + ⊕	98
CSAH	10 poles + ⊕	99
CDC	10 poles + ⊕	104
MIXO	1 module	264 - 316

bulkhead mounting housings with single lever



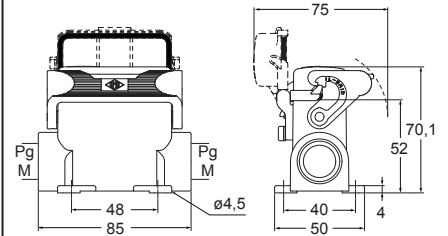
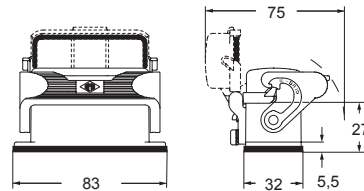
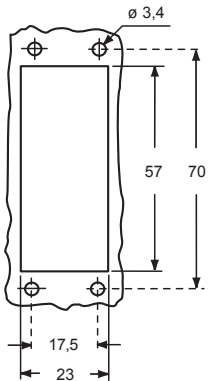
surface mounting housings with single lever



description	part No.	part No.	entry Pg	part No.	entry M
with single lever and cover	CZI 15 LSP				
with lever and cover		CZP 15 LSP16	16	MZP 15 LSP20	20
with lever and cover		CZP 15 LSP21	21	MZP 15 LSP25	25

☑ The enclosures ensure IP65 degree of protection when mated and locked with the closing lever, or IP44 protection when not mated and locked with lever, thanks to the SIMPLEX self-closing cover.

panel cut-out for bulkhead mounting housings



CAVUS Type 4/4X/12



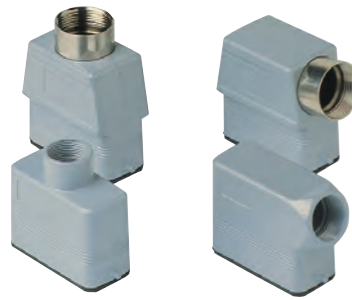
CAVUS Type 4/4X/12 pending



CZ - CZA - CZF and MZ - MZA - MZF IL-BRID standard version

inserts		page:
CD	15 poles + ⊕	68
CDA	10 poles + ⊕	98
CSAH	10 poles + ⊕	99
CDC	10 poles + ⊕	104
MIXO	1 module	264 - 316

hoods with 2 pegs



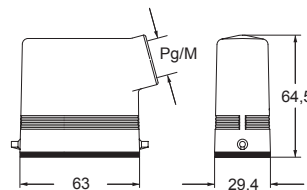
hoods with single lever



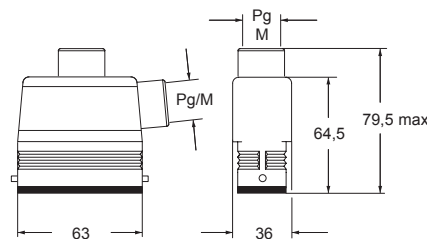
description	part No.	entry Pg	part No.	entry M	part No.	entry Pg	part No.	entry M
with pegs, side entry	CZO 15 L	16	MZO 15 L20	20				
with pegs, side entry			MZO 15 L25	25				
with pegs, side entry, high construction	CZAO 15 L16	16	MZAO 15 L20	20				
with pegs, side entry, high construction	CZAO 15 L21	21	MZAO 15 L25	25				
with pegs, top entry	CZV 15 L	13,5	MZV 15 L20	20				
with pegs, top entry, high construction	CZAV 15 L16	16	MZAV 15 L20	20				
with pegs, top entry, high construction	CZAV 15 L21	21	MZAV 15 L25	25				
with pegs, side entry, high construction, without adapter ¹⁾	CZFO 15 L16	16	MZFO 15 L20	20				
with pegs, side entry, high construction, without adapter ¹⁾	CZFO 15 L21	21	MZFO 15 L25	25				
with pegs, top entry, high construction, without adapter ¹⁾	CZFV 15 L16	16	MZFV 15 L20	20				
with pegs, top entry, high construction, without adapter ¹⁾	CZFV 15 L21	21	MZFV 15 L25	25				
with single lever, top entry			CZV 15 LG	13,5			MZV 15 LG20	20

¹⁾ enclosure without adapter, threaded on the body, to be used only with a complete cable gland.

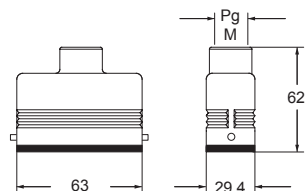
CZO L and MZO L ▲



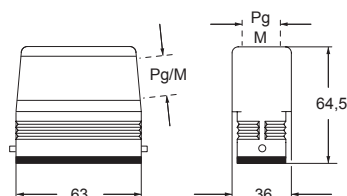
CZAO L - MZAO L and CZAV L - MZAV L ▲



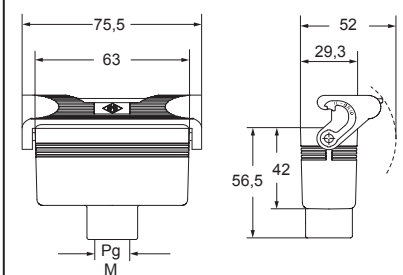
CZV L and MZV L ▲



CZFO L - MZFO L and CZFV L - MZFV L ●



CZV LG and MZV LG ▲



CAUS Type 4/4X/12



▲ insulating cable gland or fittings without gasket



▲ cable gland with O-Ring gasket



● cable gland with O-Ring gasket
IP67 if hoods with fused pegs and without adapters, coupled with IP67 housings

CZ IL-BRID standard version

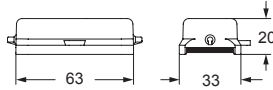
inserts		page:
CD	15 poles + ⊕	68
CDA	10 poles + ⊕	98
CSAH	10 poles + ⊕	99
CDC	10 poles + ⊕	104
MIXO	1 module	264 - 316

covers

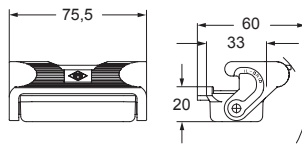


description	part No. (with eyelet)	part No. (with loop)
with pegs and gasket (for 1 lever enclosures)	CZC 15 L	CZC 15 SL
with lever (for enclosures with pegs)		CZC 15 LG

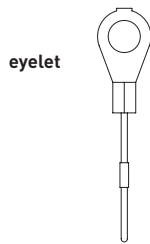
CZC L (SL) ●



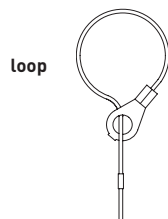
CZC LG ▲



For fixing on housings



For fixing on hoods



CEC® Type 4/4X/12



● IP67 if coupled with CZ7 - MZ7 housings (see page 384)

CZ - CZA and MZA IL-BRID standard version

inserts

CD	25 poles + ⊕
CDD	38 poles + ⊕
CDA	16 poles + ⊕
CSAH	16 poles + ⊕
CDC	16 poles + ⊕

page:

69
77
100
101
105

bulkhead mounting housings with single lever



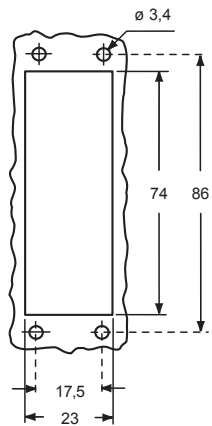
surface mounting housings with single lever



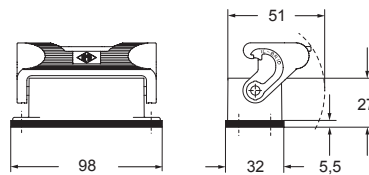
description	part No.	part No.	entry Pg	part No.	entry M
with single lever	CZI 25 L				
with single lever and cover	CZI 25 LS				
with single lever, high construction		CZAP 25 L	16		
with single lever, high construction		CZAP 25 L2	16 x 2		
with single lever, high construction		CZAP 25 L21	21	MZAP 25 L25	25
with single lever, high construction		CZAP 25 L221	21 x 2	MZAP 25 L225	25 x 2
with single lever and cover, high construction		CZAP 25 LS	16		
with single lever and cover, high construction		CZAP 25 LS2	16 x 2		
with single lever and cover, high construction		CZAP 25 LS21	21	MZAP 25 LS25	25
with single lever and cover, high construction		CZAP 25LS221	21 x 2	MZAP 25LS225	25 x 2

☑ The enclosures ensure IP66/IP69 degree of protection (or IP65 for hinged cover versions) when mated and locked with the closing levers.

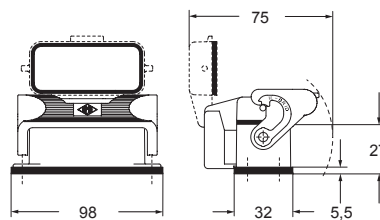
panel cut-out for bulkhead mounting housings



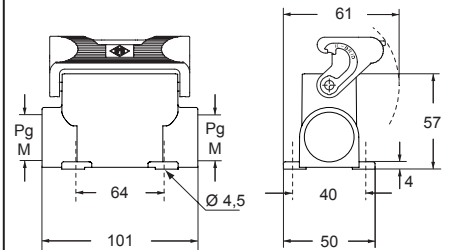
CZI L ▲



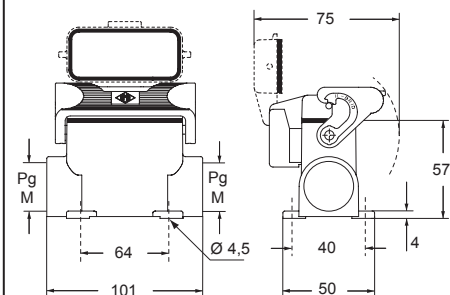
CZI LS ●



CZAP L and MZAP L ▲



CZAP LS and MZAP LS ●



CALUS Type 4/4X/12



● insulating cable gland or fittings
▲ without gasket



▲ cable gland with O-Ring gasket

CZ - CZA and MZA IL-BRID lever standard version SIMPLEX self-closing covers

inserts		page:
CD	25 poles + ⊕	69
CDD	38 poles + ⊕	77
CDA	16 poles + ⊕	100
CSAH	16 poles + ⊕	101
CDC	16 poles + ⊕	105

bulkhead mounting housings with single lever



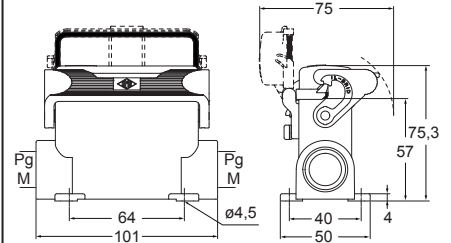
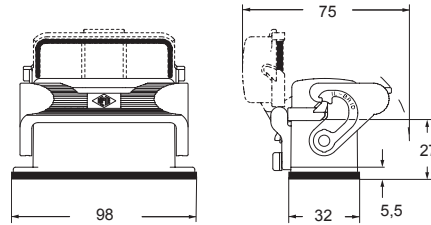
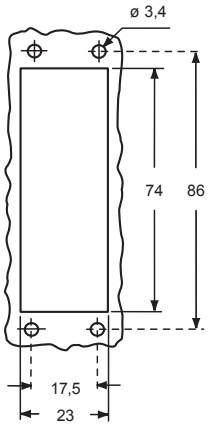
surface mounting housings with single lever



description	part No.	part No.	entry Pg	part No.	entry M
with single lever and cover	CZI 25 LSP				
with lever and cover, high construction		CZAP 25LSP16	16	MZAP 25LSP20	20
with lever and cover, high construction		CZAP 25LSP21	21	MZAP 25LSP25	25

☑ The enclosures ensure IP65 degree of protection when mated and locked with the closing lever, or IP44 protection when not mated and locked with lever, thanks to the SIMPLEX self-closing cover.

panel cut-out for bulkhead mounting housings



CAIUS Type 4/4X/12



CAIUS Type 4/4X/12 pending



CZ - CZA - CZF and MZ - MZA - MZF IL-BRID standard version

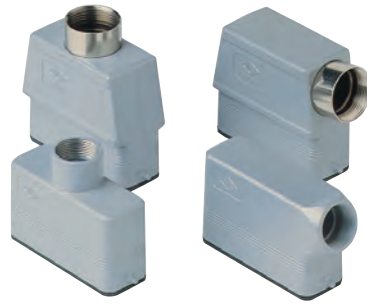
inserts

CD	25 poles + ⊕
CDD	38 poles + ⊕
CDA	16 poles + ⊕
CSAH	16 poles + ⊕
CDC	16 poles + ⊕

page:

69
77
100
101
105

hoods with 2 pegs



hoods with 2 pegs, double top entry

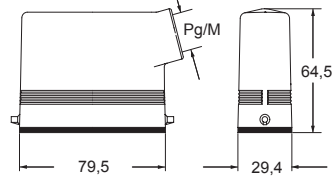


description	part No.	entry Pg	part No.	entry M	part No.	entry Pg	part No.	entry M
side entry	CZO 25 L	16	MZO 25 L20	20				
side entry			MZO 25 L25	25				
side entry, high construction	CZAO 25 L16	16	MZAO 25 L20	20				
side entry, high construction	CZAO 25 L21	21	MZAO 25 L25	25				
top entry	CZV 25 L	16						
top entry 2)			MZV 25 L20	20				
top entry, high construction	CZAV 25 L16	16	MZAV 25 L20	20				
top entry, high construction	CZAV 25 L21	21	MZAV 25 L25	25				
side entry, high construction, without adapter 1)	CZFO 25 L16	16	MZFO 25 L20	20				
side entry, high construction, without adapter 1)	CZFO 25 L21	21	MZFO 25 L25	25				
top entry, high construction, without adapter 1)	CZFV 25 L16	16	MZFV 25 L20	20				
top entry, high construction, without adapter 1)	CZFV 25 L21	21	MZFV 25 L25	25				
with pegs for 1 lever, high construction					CZAV 25 L216	16 x 2	MZAV 25 L220	20 x 2
with pegs for 1 lever, high construction, without adapter 1)					CZFV 25 L216	16 x 2	MZFV 25 L220	20 x 2

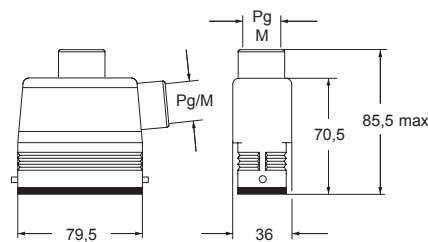
1) enclosure without adapter, threaded on the body, to be used only with a complete cable gland.

2) can only be used with a complete cable gland (to be purchased separately).

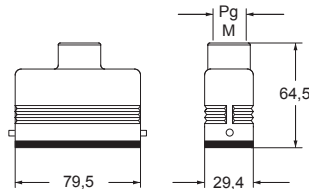
CZO L and MZO L ▲



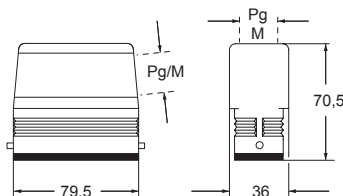
CZAO L - MZAO L and CZAV L - MZAV L ▲



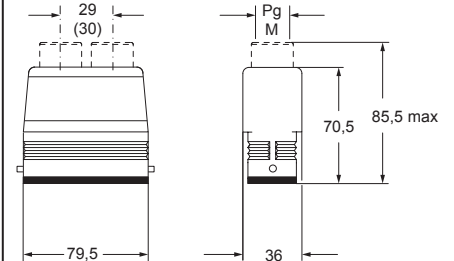
CZV L and MZV L ▲



CZFO L - MZFO L and CZFV L - MZFV L ●



CZAV/CZFV L2 and (MZAV)/MZFV L2 ●



CALUS Type 4/4X/12

▲ ● insulating cable gland or fittings without gasket

▲ cable gland with O-Ring gasket

● cable gland with O-Ring gasket
 IP67 if hoods with fused pegs and without adapters, coupled with IP67 housings

CZ and MZ IL-BRID standard version

inserts		page:
CD	25 poles + ⊕	69
CDD	38 poles + ⊕	77
CDA	16 poles + ⊕	100
CSAH	16 poles + ⊕	101
CDC	16 poles + ⊕	105

hoods with single lever

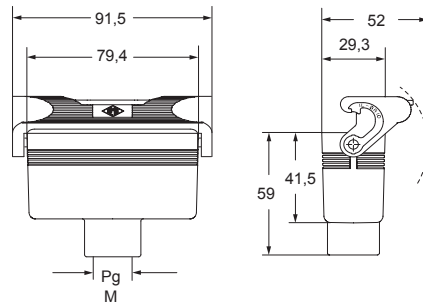


covers

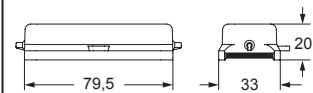


description	part No.	entry Pg	part No.	entry M	part No. (with eyelet)	part No. (with loop)
with single lever, top entry	CZV 25 LG	16	MZV 25 LG20	20		
with pegs and gasket (for 1 lever enclosures)					CZC 25 L	CZC 25 SL
with lever (for enclosures with pegs)						CZC 25 LG

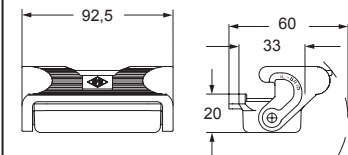
CZV LG and MZV LG ▲



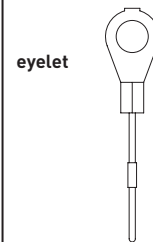
CZC L (SL) ●



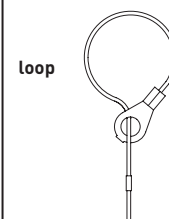
CZC LG ▲



For fixing on housings



For fixing on hoods



CAIUS Type 4/4X/12



▲ insulating cable gland or fittings without gasket



▲ cable gland with O-Ring gasket



● IP67 if coupled with CZ7 - MZ7 housings (see page 385)

CZAC IL-BRID standard version

inserts		page:
size "49.16"		
CD	15 poles + ⊕	68
CDA	10 poles + ⊕	98
CSAH	10 poles + ⊕	99
CDC	10 poles + ⊕	104
MIXO	1 module	264 - 316
size "66.16"		
CD	25 poles + ⊕	69
CDD	38 poles + ⊕	77
CDA	16 poles + ⊕	100
CSAH	16 poles + ⊕	101
CDC	16 poles + ⊕	105

hoods without entry, to be drilled



hoods without entry, to be drilled



description

part No.
(with 2 pegs)

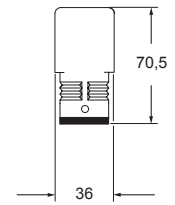
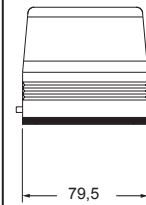
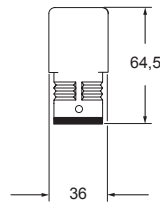
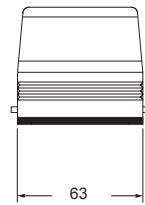
part No.
(with 2 pegs)

with pegs, high construction
used with enclosures size "49.16"

CZAC 15 L

with pegs, high construction
used with enclosures size "66.16"

CZAC 25 L



IL-BRID

CAIUS® Type 4/4X/12



IP66 if coupled with CZ7 - MZ7 housings
(see page 384 or 385)

CZ7 - MZ7

Rigid coupling

Enclosures with rigid stainless steel lever to assure an IP66/IP67/IP69 dust and watertight seal.



SUM-UP

- ☑ **CZ7 and MZ7 series: stainless steel locking lever, rigid**
 - ☑ **Sizes 49.16, 66.16**
 - ☑ **With and without hinged cover**
 - ☑ **Bulkhead or surface mounting**
 - ☑ **Recommended in case of vibrations or heavy weight of cables.**
- ✔ IP65, IP66/IP67/IP69 degrees of protection according to model.

☑ Characteristics of materials for CZ7 and MZ7 series

- Made of die cast aluminium alloy;
- with epoxy-polyester thermosetting powder coating;
- gaskets in anti-aging, oil-resistant, grease-resistant and fuel-resistant vinyl nitrile elastomer;
- locking device integrally in stainless steel;
- ambient temperature range: -40 °C / +125 °C.

CZ7 - MZ7 standard version RIGID LEVER

inserts		page:
CD	15 poles + ⊕	68
CDA	10 poles + ⊕	98
CSAH	10 poles + ⊕	99
CDC	10 poles + ⊕	104
MIXO	1 module	264 - 316

bulkhead mounting housings with single lever



STAINLESS STEEL LEVER

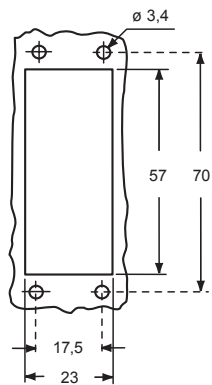
surface mounting housings with single lever



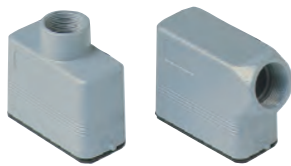
STAINLESS STEEL LEVER

description	part No.	part No.	entry M
with single lever	CZ7I 15 L	MZ7P 15 L25	25
with single lever and cover	CZ7I 15 LS	MZ7P 15 L225	25 x 2
with single lever		MZ7P 15 LS25	25
with single lever and cover		MZ7P 15LS225	25 x 2

panel cut-out for bulkhead mounting housings



Hoods (page 376)



The rigid lever offers an IP66/IP67/IP69 degree of protection (according to EN 60529) when fitted with a complete and coupled connector and used with ILME standard hoods in die cast aluminum with pegs (without adapter).

CAUS® Type 4/4X/12

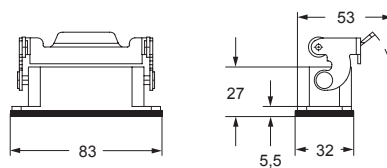


insulating cable gland or fittings without gasket

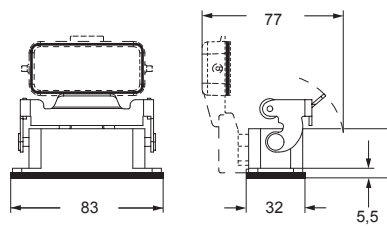


cable gland with O-Ring gasket
IP67 if coupled with IP67 hood or cover

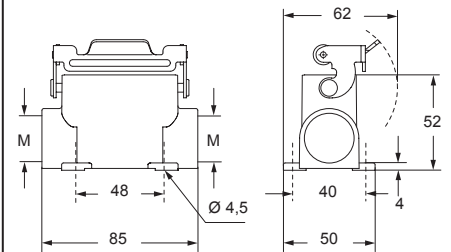
CZ7I L



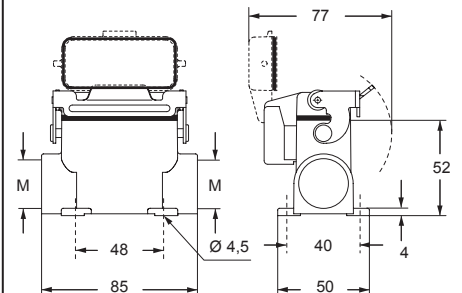
CZ7I LS



MZ7P L



MZ7P LS



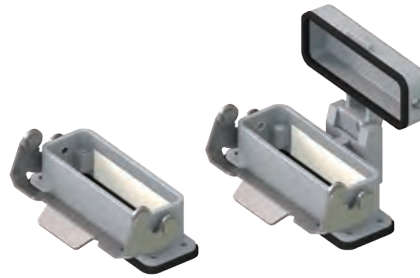
For bulkhead mounting housings, IP66/IP67/IP69 degree of protection is guaranteed for mounting on a sufficiently rigid panel; use M3 screws of suitable length (negligible surface buckling when subjected to tightening torque on the fixing screws of 0,9 - 1 Nm or to deformation caused by the weight of the complete connector).

In addition, the panel surface in contact with the flange gasket of the bulkhead mounting housings must be free from defects (deep scratches, grooves, burrs) that could negatively affect the performance of the gasket.

CZ7 - MZ7 standard version RIGID LEVER

inserts		page:
CD	25 poles + ⊕	69
CDD	38 poles + ⊕	77
CDA	16 poles + ⊕	100
CSAH	16 poles + ⊕	101
CDC	16 poles + ⊕	105

bulkhead mounting housings with single lever



STAINLESS STEEL LEVER

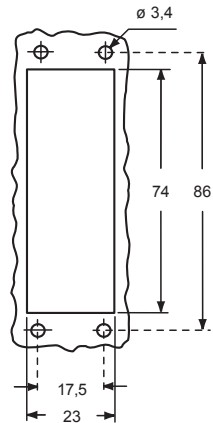
surface mounting housings with single lever



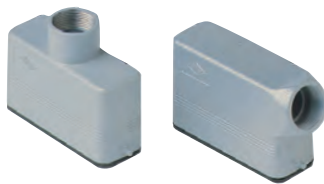
STAINLESS STEEL LEVER

description	part No.	part No.	entry M
with single lever	CZ7I 25 L	MZ7P 25 L25	25
with single lever and cover	CZ7I 25 LS	MZ7P 25 L225	25 x 2
with single lever		MZ7P 25 LS25	25
with single lever and cover		MZ7P 25LS225	25 x 2

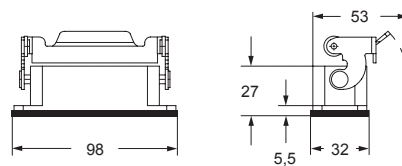
panel cut-out for bulkhead mounting housings



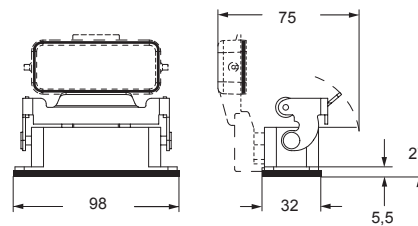
Hoods
(page 380)



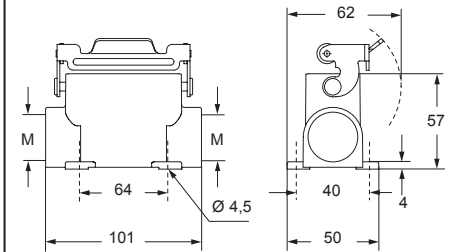
CZ7I L



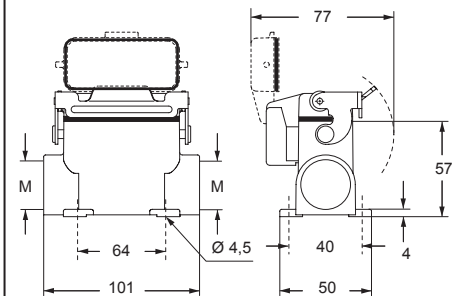
CZ7I LS



MZ7P L



MZ7P LS



The rigid lever offers an IP66/IP67/IP69 degree of protection (according to EN 60529) when fitted with a complete and coupled connector and used with ILME standard hoods in die cast aluminum with pegs (without adapter).

For bulkhead mounting housings, IP66/IP67/IP69 degree of protection is guaranteed for mounting on a sufficiently rigid panel; use M3 screws of suitable length (negligible surface buckling when subjected to tightening torque on the fixing screws of 0,9 - 1 Nm or to deformation caused by the weight of the complete connector).

In addition, the panel surface in contact with the flange gasket of the bulkhead mounting housings must be free from defects (deep scratches, grooves, burrs) that could negatively affect the performance of the gasket.

CAUS® Type
4/4X/12

insulating cable gland or fittings without gasket

cable gland with O-Ring gasket
IP67 if coupled with IP67 hood or cover

C-TYPE

The classic choice

This series has been developed for application in electrical and electronic machinery, control units, electrical panels, control equipment, in industrial environments and in general, wherever a reliable and easily disconnectable connection is required for power and signal circuits.



SUM-UP

📌 **The inserts of the CMCE series (except the 16+2 poles) and of the CMSH series may use standard enclosures also for uses of up to 830V**

✔ **UL certified for USA and Canada for Type 4, 4X (outdoor use) and 12 (indoor use) degrees of protection (enclosure type rating), marked on the packaging.**
IP65 or IP66/IP69 degrees of protection according to model.

📄 **Characteristics of materials for CH, CA and MH, MA, MF series**

- Made of die cast aluminium alloy;
- with epoxy-polyester thermosetting powder coating;
- gaskets in anti-aging, oil-resistant, grease-resistant and fuel-resistant vinyl nitrile elastomer;
- locking device with levers, springs and pins in stainless steel;
- lever handles in self-extinguishing thermoplastic material reinforced with glass fibres, UL approved (for CH, CA and MH, MA enclosures);
- ambient temperature range: -40 °C / +125 °C.

CH C-TYPE standard version

inserts		page:
CDD	24 poles + ⊕	76
CDS	9 poles + ⊕	-
CDSH	9 poles + ⊕	86
CDSH NC	6 poles + ⊕	95
CNE	6 poles + ⊕	110
CSE	6 poles + ⊕	-
CSH	6 poles + ⊕	110
CSH S	6 poles + ⊕	122
CCE	6 poles + ⊕	130
CSS	6 poles + ⊕	148
CT, CTSE (16A) *)	6 poles + ⊕	160
CQE	10 poles + ⊕	168
MIXO	2 modules	262 - 317

*) can be used only in bulkhead mounting housings

bulkhead mounting housings with single lever



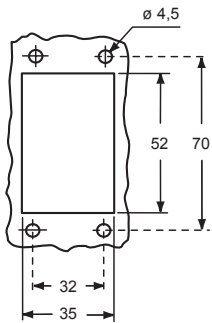
bulkhead mounting housings with 2 pegs



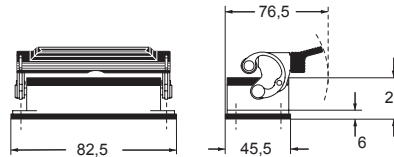
description	part No.	part No.
with lever	CHI 06 L	
with lever and cover	CHI 06 LS	
with pegs 1)		CHI 06 LC
with pegs and aluminum cover 1)		CHI 06 LCS
with pegs and plastic cover 1)		CHI 06 LCP

1) may be combined with enclosures:
 - CHO/CHV 06 LX
 - MHO/MHV 06 LX

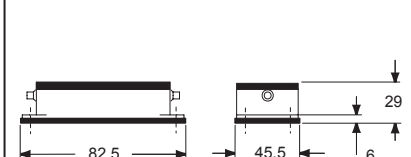
panel cut-out for bulkhead mounting housings



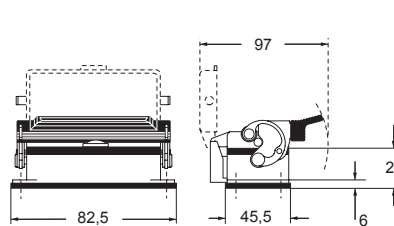
CHI L ▲



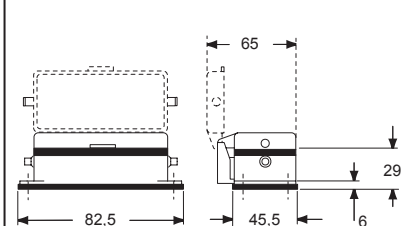
CHI LC ▲



CHI LS ●



CHI LCS/LCP ●



Q IMPORTANT NOTE: The enclosures ensure IP66/IP69 degree of protection (or IP65 for hinged cover versions) when mated and locked with the closing levers.
 The cover (CS, CP) only ensures mechanical protection, but does not ensure IP65 degree of protection.

CAUS Type 4/4X/12
 (except enclosures with plastic cover)



CH - CA and MH - MA C-TYPE standard version

inserts		page:
CDD	24 poles + ⊕	76
CDS	9 poles + ⊕	-
CDSH	9 poles + ⊕	86
CDSH NC	6 poles + ⊕	95
CNE	6 poles + ⊕	110
CSE	6 poles + ⊕	-
CSH	6 poles + ⊕	110
CSH S	6 poles + ⊕	122
CCE	6 poles + ⊕	130
CSS	6 poles + ⊕	148
CQE	10 poles + ⊕	168
MIXO	2 modules	262 - 317

surface mounting housings with single lever



angled surface mounting housings with single lever

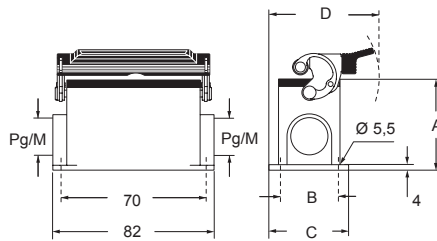


description	part No.	entry Pg	part No.	entry M	part No.	entry M
with lever	CHP 06 L	16	MHP 06 L20	20		
with lever	CHP 06 L2	16 x 2	MHP 06 L220	20 x 2		
with lever, high construction 1)			MAP 06 L25	25		
with lever, high construction 1)			MAP 06 L225	25 x 2		
with lever, high construction	CAP 06 L	21	MAP 06 L32	32		
with lever, high construction	CAP 06 L2	21 x 2	MAP 06 L232	32 x 2		
with lever, high construction	CAP 06 L29	29	MAP 06 L40	40		
with lever, high construction	CAP 06 L229	29 x 2	MAP 06 L240	40 x 2		
with lever and cover	CHP 06 LS	16	MHP 06 LS20	20		
with lever and cover	CHP 06 LS2	16 x 2	MHP 06 LS220	20 x 2		
with lever and cover, high construction	CAP 06 LS	21	MAP 06 LS32	32		
with lever and cover, high construction	CAP 06 LS2	21 x 2	MAP 06 LS232	32 x 2		
with lever and cover, high construction	CAP 06 LS29	29	MAP 06 LS40	40		
with lever and cover, high construction	CAP 06 LS229	29 x 2	MAP 06 LS240	40 x 2		
with lever, cable gland entry, closed bulkhead 1) 2)					MAV 06LG25-F	25

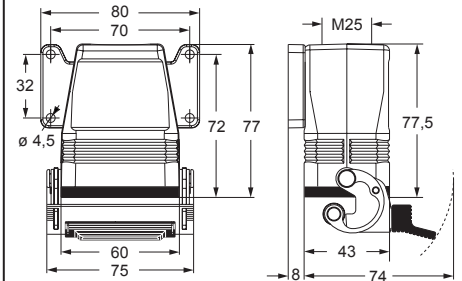
1) be used only with a complete cable gland (to be purchased separately).
 2) versions with M32, Pg 21 or Pg 29 entry on request.

Q IMPORTANT NOTE: The enclosures ensure IP66/IP69 degree of protection (or IP65 for hinged cover versions) when mated and locked with the closing levers. The cover (CS, CP) only ensures mechanical protection, but does not ensure IP65 degree of protection.

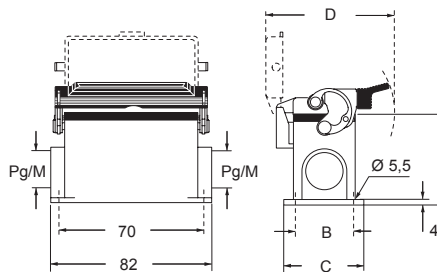
CHP L - CAP L and MHP L - MAP L ▲



MAV 06LG25-F ▲



CHP LS - CAP LS and MHP LS - MAP LS ●



type	A	B	C	D
CHP L / MHP L	53	40	52	79,5
CAP L / MAP L	74	45	57	82
CHP LS / MHP LS	53	40	52	97
CAP LS / MAP LS	74	45	57	97

CAIUS Type 4/4X/12



▲ insulating cable gland or fittings without gasket



▲ cable gland with O-Ring gasket

CH - CA - CF and MH - MA - MF C-TYPE standard version

inserts		page:
CDD	24 poles + ⊕	76
CDS	9 poles + ⊕	-
CDSH	9 poles + ⊕	86
CDSH NC	6 poles + ⊕	95
CNE	6 poles + ⊕	110
CSE	6 poles + ⊕	-
CSH	6 poles + ⊕	110
CSH S	6 poles + ⊕	122
CCE	6 poles + ⊕	130
CSS	6 poles + ⊕	148
CQE	10 poles + ⊕	168
MIXO	2 modules	262 - 317

hoods with 2 pegs



hoods with 2 pegs

M40 cable entry with 20 mm thread length



description	part No.	entry Pg	part No.	entry M	part No.	entry M
with pegs, side entry	CHO 06 L13	13,5	MHO 06 L20	20		
with pegs, side entry	CHO 06 L16	16	MHO 06 L25	25		
with pegs, side entry, high construction	CAO 06 L21	21	MAO 06 L25	25		
with pegs, side entry, high construction	CAO 06 L29	29	MAO 06 L32	32		
with pegs, side entry, high construction, without adapter ¹⁾	CFO 06 L21	21	MFO 06 L25	25		
with pegs, side entry, high construction, without adapter ¹⁾	CFO 06 L29	29	MFO 06 L32	32		
with pegs, side entry, high construction, without adapter ¹⁾					MFO 06 L40	40
with pegs, top entry ²⁾	CHV 06 L13	13,5				
with pegs, top entry ^{2) 3)}			MHV 06 L20	20		
with pegs, top entry ²⁾	CHV 06 L16	16	MHV 06 L25	25		
with pegs, top entry, high construction	CAV 06 L21	21	MAV 06 L25	25		
with pegs, top entry, high construction	CAV 06 L29	29	MAV 06 L32	32		
with pegs, top entry, high construction, without adapter ¹⁾	CFV 06 L21	21	MFV 06 L25	25		
with pegs, top entry, high construction, without adapter ¹⁾	CFV 06 L29	29	MFV 06 L32	32		
with pegs, top entry, high construction, without adapter ¹⁾					MFV 06 L40	40

¹⁾ enclosure without adapter, threaded on the body, to be used only with a complete cable gland.

²⁾ cannot be used with MIXO series.

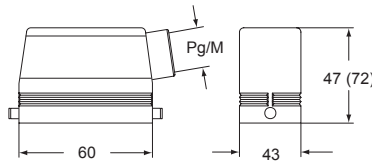
³⁾ can only be used with a complete cable gland (to be purchased separately).

IP degrees are according to the type of lever of the counterpart enclosures.

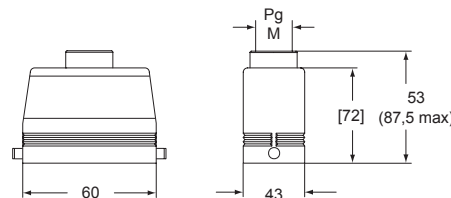
Alternatively, hoods with pegs may be coupled with fixed enclosures:

- C-TYPE, IP65 or IP66/IP69 stainless steel lever, from page 387 to page 391
- C7, IP66/IP67/IP69 stainless steel lever, page 436
- CV, IP65 or IP66/IP69 stainless steel lever, page 444 and 445

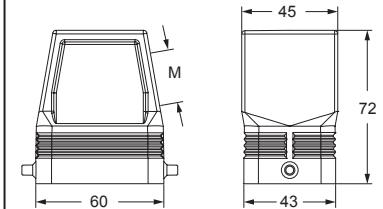
CHO L (CAO L) and (CFO L) MHO L (MAO L) and (MFO L)



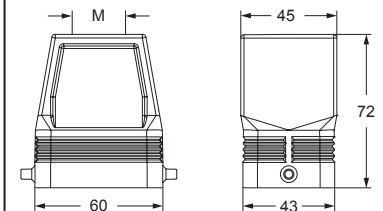
CHV L (CAV L) and [CFV L] MHV L (MAV L) and [MFV L]



MFO 06 L40



MFV 06 L40



CALUS Type 4/4X/12

insulating cable gland or fittings without gasket

cable gland with O-Ring gasket
IP67 if hoods without adapters coupled with IP67 housings

CH - CA - CF and MH - MA - MF C-TYPE standard version

inserts		page:
CDD	24 poles + ⊕	76
CDS	9 poles + ⊕	-
CDSH	9 poles + ⊕	86
CDSH NC	6 poles + ⊕	95
CNE	6 poles + ⊕	110
CSE	6 poles + ⊕	-
CSH	6 poles + ⊕	110
CSH S	6 poles + ⊕	122
CCE	6 poles + ⊕	130
CSS	6 poles + ⊕	148
CQE	10 poles + ⊕	168
MIXO	2 modules	262 - 317

hoods with 1 lever



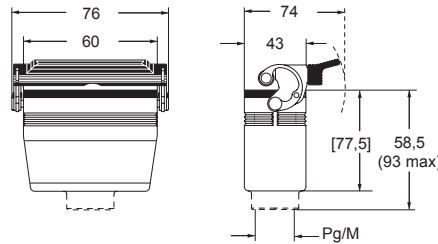
hoods with 1 lever
M40 cable entry with 20 mm thread length



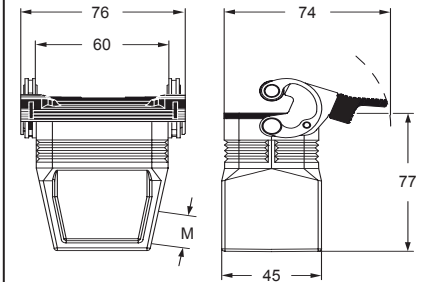
description	part No.	entry Pg	part No.	entry M	part No.	entry M
with lever, top entry	CHV 06 LG	16	MHV 06 LG25	25		
with lever, top entry, high construction	CAV 06 LG21	21	MAV 06 LG25	25		
with lever, top entry, high construction	CAV 06 LG29	29	MAV 06 LG32	32		
with lever, side entry, high construction, without adapter 1)					MFO 06 LG40	40
with lever, top entry, high construction, without adapter 1)	CFV 06 LG21	21	MFV 06 LG25	25		
with lever, top entry, high construction, without adapter 1)	CFV 06 LG29	29	MFV 06 LG32	32		
with lever, top entry, high construction, without adapter 1)					MFV 06 LG40	40

1) enclosure without adapter, threaded on the body, to be used only with a complete cable gland.

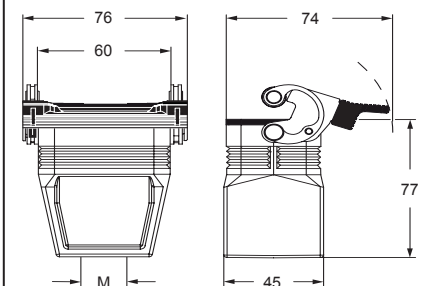
**CHV LG (CAV LG) and [CFV LG]
MHV LG (MAV LG) and [MFV LG]**




MFO 06 LG40




MFV 06 LG40



CAIUS® Type 4/4X/12

 insulating cable gland or fittings without gasket

 cable gland with O-Ring gasket

C-TYPE

CH and MH C-TYPE standard version

inserts		page:
CDD	24 poles + ⊕	76
CDS	9 poles + ⊕	-
CDSH	9 poles + ⊕	86
CDSH NC	6 poles + ⊕	95
CNE	6 poles + ⊕	110
CSE	6 poles + ⊕	-
CSH	6 poles + ⊕	110
CSH S	6 poles + ⊕	122
CCE	6 poles + ⊕	130
CSS	6 poles + ⊕	148
CQE	10 poles + ⊕	168
MIXO	2 modules	262 - 317

hoods with 1 lever



covers



description	part No.	entry Pg	part No.	entry M	part No. (with eyelet)	part No. (with loop)
with lever, without gasket, side entry ¹⁾³⁾	CHO 06 LX16	16	MHO 06 LX20	20		
with lever, without gasket, side entry ¹⁾³⁾			MHO 06 LX25	25		
with lever, without gasket, top entry ¹⁾³⁾	CHV 06 LX16	16	MHV 06 LX20	20		
with lever, without gasket, top entry ¹⁾³⁾			MHV 06 LX25	25		
with lever (for hoods with pegs)						CHC 06 LG
with pegs (for enclosures with lever)					CHC 06 L	CHC 06 SL
with pegs and gasket (for hoods with lever) ²⁾						CHC 06 LC

¹⁾ may be combined with enclosures:
CHI 06 LCS/LCP/LC

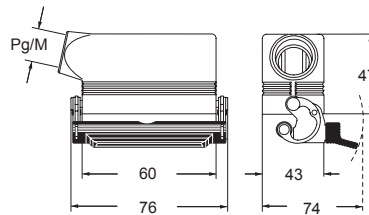
²⁾ may be combined with enclosures:
- CHO/CHV 06 LX
- MHO/MHV 06 LX

³⁾ cannot be used with MIXO series

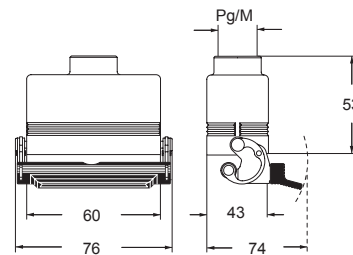
CHCP 06
dust protection cover
(page 696)



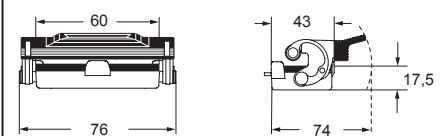
CHO LX and MHO LX



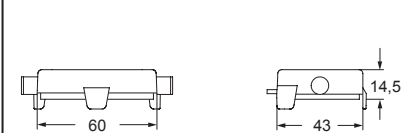
CHV LX and MHV LX



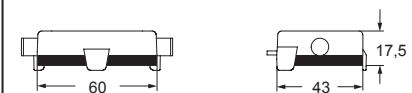
CHC LG



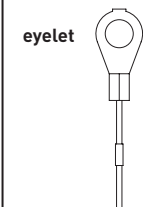
CHC L (SL)



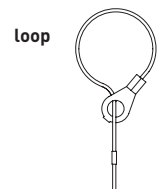
CHC LC



For fixing on housings



For fixing on hoods



CUUS Type 4/4X/12



CAC C-TYPE standard version

inserts		page:
CDD	24 poles + ⊕	76
CDS	9 poles + ⊕	-
CDSH	9 poles + ⊕	86
CDSH NC	6 poles + ⊕	95
CNE	6 poles + ⊕	110
CSE	6 poles + ⊕	-
CSH	6 poles + ⊕	110
CSH S	6 poles + ⊕	122
CCE	6 poles + ⊕	130
CSS	6 poles + ⊕	148
CQE	10 poles + ⊕	168
MIXO	2 modules	262 - 317

hoods without entry, to be drilled



description

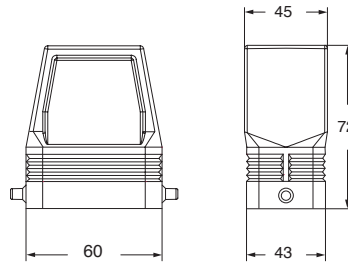
part No.
(with 2 pegs)

with pegs, high construction

CAC 06 L

Alternatively, hoods with pegs are coupled with fixed enclosures:

- C-TYPE, IP65 or IP66/IP69 stainless steel lever, from page 387 to page 391
- C7, IP66/IP67/IP69 stainless steel lever, page 436
- CV, IP65 or IP66/IP69 stainless steel lever, page 444 and 445



CAUS® Type 4/4X/12



IP67 if coupled with IP67 hood or cover

CH C-TYPE standard version

inserts		page:
CDD	42 poles + ⊕	78
CDS	18 poles + ⊕	-
CDSH	18 poles + ⊕	87
CNE	10 poles + ⊕	111
CSE	10 poles + ⊕	-
CSH	10 poles + ⊕	111
CSH S	10 poles + ⊕	123
CCE	10 poles + ⊕	131
CMSH	3+2 (aux) poles + ⊕	136
CMCE	3+2 (aux) poles + ⊕	137
CSS	10 poles + ⊕	149
CT, CTSE (16A) *)	10 poles + ⊕	161
CQE	18 poles + ⊕	169
CX	8/24 poles + ⊕	194
MIXO	3 modules	262 - 317

*) can be used only in bulkhead mounting housings

bulkhead mounting housings with 2 levers or 4 pegs



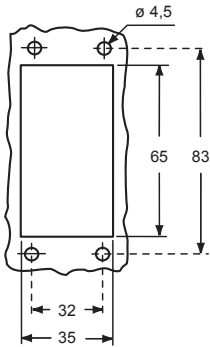
bulkhead mounting housings with single lever



description	part No.	part No.
with one or two levers	CHI 10	CHI 10 L
with pegs 1)	CHI 10 C	
with pegs and aluminum cover 1)	CHI 10 CS	
with pegs and plastic cover 1)	CHI 10 CP	
with lever and cover		CHI 10 LS

1) may be combined with enclosures:
 - CHO/CAO 10 X and CHV/CAV 10 X
 - MHO/MAO 10 X and MHV/MAV 10 X

panel cut-out for bulkhead mounting housings



IMPORTANT NOTE: The enclosures ensure IP66/IP69 degree of protection (or IP65 for hinged cover versions) when mated and locked with the closing levers. The cover (CS, CP) only ensures mechanical protection, but does not ensure IP65 degree of protection.

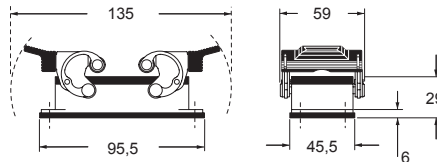
CR CLK
locking device for CLASS locking levers (page 666)



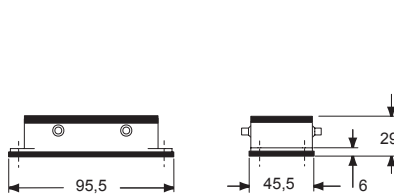
CAUS® Type 4/4X/12
(except enclosures with plastic cover)



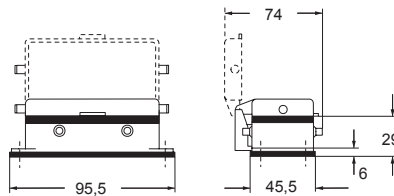
CHI ▲



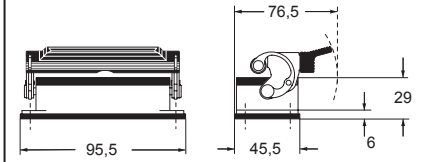
CHI C ▲



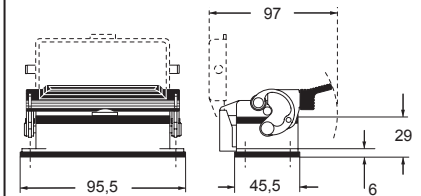
CHI CS/CP ●



CHI L ▲



CHI LS ●



ANGLED VERSION
(page 450)



CH - CA and MH - MA C-TYPE standard version

inserts		page:
CDD	42 poles + ⊕	78
CDS	18 poles + ⊕	-
CDSH	18 poles + ⊕	87
CNE	10 poles + ⊕	111
CSE	10 poles + ⊕	-
CSH	10 poles + ⊕	111
CSH S	10 poles + ⊕	123
CCE	10 poles + ⊕	131
CMSH	3+2 (aux) poles + ⊕	136
CMCE	3+2 (aux) poles + ⊕	137
CSS	10 poles + ⊕	149
CQE	18 poles + ⊕	169
CX	8/24 poles + ⊕	194
MIXO	3 modules	262 - 317

surface mounting housings with 2 levers or 4 pegs



surface mounting housings with single lever



description	part No.	entry Pg	part No.	entry M	part No.	entry Pg	part No.	entry M
with lever/s	CHP 10	16	MHP 10.20	20	CHP 10 L	16	MHP 10 L20	20
with lever/s	CHP 10.2	16 x 2	MHP 10.220	20 x 2	CHP 10 L2	16 x 2	MHP 10 L220	20 x 2
with levers, high construction 1)			MAP 10.25	25				
with levers, high construction 1)			MAP 10.225	25 x 2				
with lever/s, high construction	CAP 10.21	21	MAP 10.32	32	CAP 10 L	21	MAP 10 L32	32
with lever/s, high construction	CAP 10.221	21 x 2	MAP 10.232	32 x 2	CAP 10 L2	21 x 2	MAP 10 L232	32 x 2
with lever/s, high construction	CAP 10.29	29	MAP 10.40	40	CAP 10 L29	29	MAP 10 L40	40
with lever/s, high construction	CAP 10.229	29 x 2	MAP 10.240	40 x 2	CAP 10 L229	29 x 2	MAP 10 L240	40 x 2
with pegs and aluminum cover 2)	CHP 10 CS	16	MHP 10 CS20	20				
with pegs and aluminum cover 2)	CHP 10 CS2	16 x 2	MHP 10 CS220	20 x 2				
with pegs and aluminum cover, high construction 2)	CAP 10 CS	21	MAP 10 CS32	32				
with pegs and aluminum cover, high construction 2)	CAP 10 CS2	21 x 2	MAP 10 CS232	32 x 2				
with pegs and aluminum cover, high construction 2)	CAP 10 CS29	29	MAP 10 CS40	40				
with pegs and aluminum cover, high construction 2)	CAP 10 CS229	29 x 2	MAP 10 CS240	40 x 2				
with pegs and plastic cover 2)	CHP 10 CP	16	MHP 10 CP20	20				
with pegs and plastic cover 2)	CHP 10 CP2	16 x 2	MHP 10 CP220	20 x 2				
with pegs and plastic cover, high construction 2)	CAP 10 CP	21	MAP 10 CP32	32				
with pegs and plastic cover, high construction 2)	CAP 10 CP2	21 x 2	MAP 10 CP232	32 x 2				
with pegs and plastic cover, high construction 2)	CAP 10 CP29	29	MAP 10 CP40	40				
with pegs and plastic cover, high construction 2)	CAP 10 CP229	29 x 2	MAP 10 CP240	40 x 2				
with lever and aluminium cover	CHP 10 LS	16	MHP 10 LS20	20				
with lever and aluminium cover	CHP 10 LS2	16 x 2	MHP 10 LS220	20 x 2				
with lever and aluminium cover, high construction	CAP 10 LS	21	MAP 10 LS32	32				
with lever and aluminium cover, high construction	CAP 10 LS2	21 x 2	MAP 10 LS232	32 x 2				
with lever and aluminium cover, high construction	CAP 10 LS29	29	MAP 10 LS40	40				
with lever and aluminium cover, high construction	CAP 10 LS229	29 x 2	MAP 10 LS240	40 x 2				

1) can only be used only with a complete cable gland (to be purchased separately)

2) may be combined with enclosures:
 - CHO/CAO 10 X and CHV/CAV 10 X
 - MHO/MAO 10 X and MHV/MAV 10 X

IMPORTANT NOTE: The enclosures ensure IP66/IP69 degree of protection (or IP65 for hinged cover versions) when mated and locked with the closing levers. The cover (CS, CP) only ensures mechanical protection, but does not ensure IP65 degree of protection.

CR CLK
locking device for CLASS locking levers (page 666)



CRUS® Type 4/4X/12
(except enclosures with plastic cover)

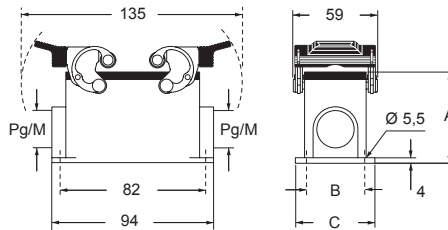


insulating cable gland or fittings without gasket

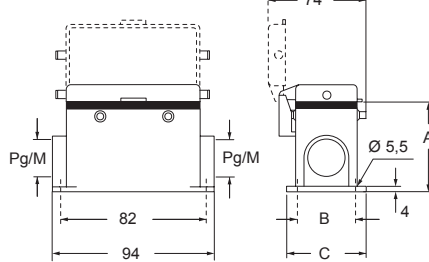


cable gland with O-Ring gasket

CHP - CAP and MHP - MAP ▲

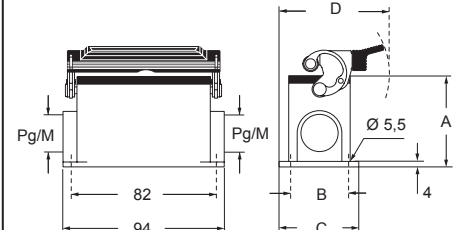


CHP CS/CP - CAP CS/CP and MHP CS/CP - MAP CS/CP ●

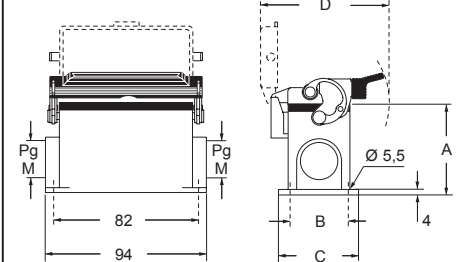


type	A	B	C
CHP / MHP	57	40	52
CAP / MAP	74	45	57
CHP CS / MHP CS	57	40	52
CAP CS / MAP CS	74	45	57
CHP CP / MHP CP	57	40	52
CAP CP / MAP CP	74	45	57

CHP L - CAP L and MHP L - MAP L ▲



CHP LS - CAP LS and MHP LS - MAP LS ●



type	A	B	C	D
CHP L / MHP L	57	40	52	79,5
CAP L / MAP L	74	45	57	82
CHP LS / MHP LS	57	40	52	97
CAP LS / MAP LS	74	45	57	97

CH - CA - CF and MH - MA - MF C-TYPE standard version

inserts		page:
CDD	42 poles + ⊕	78
CDS	18 poles + ⊕	-
CDSH	18 poles + ⊕	87
CNE	10 poles + ⊕	111
CSE	10 poles + ⊕	-
CSH	10 poles + ⊕	111
CSH S	10 poles + ⊕	123
CCE	10 poles + ⊕	131
CMSH	3+2 (aux) poles + ⊕	136
CMCE	3+2 (aux) poles + ⊕	137
CSS	10 poles + ⊕	149
CQE	18 poles + ⊕	169
CX	8/24 poles + ⊕	194
MIXO	3 modules	262 - 317

hoods with 4 pegs



hoods with 4 pegs

M40 cable entry with 20 mm thread length



description	part No.	entry Pg	part No.	entry M	part No.	entry Pg	part No.	entry M
with pegs, side entry	CHO 10	16	MHO 10.20	20				
with pegs, side entry			MHO 10.25	25				
with pegs, side entry, high construction	CAO 10.21	21	MAO 10.32	32				
with pegs, side entry, high construction	CAO 10.29	29	MAO 10.40	40				
with pegs, side entry, high construction, without adapter ¹⁾					CFO 10.21	21	MFO 10.32	32
with pegs, side entry, high construction, without adapter ¹⁾					CFO 10.29	29	MFO 10.40	40
with pegs, top entry	CHV 10	16						
with pegs, top entry ²⁾			MHV 10.20	20				
with pegs, top entry			MHV 10.25	25				
with pegs, top entry, high construction	CAV 10.21	21	MAV 10.32	32				
with pegs, top entry, high construction	CAV 10.29	29	MAV 10.40	40				
with pegs, top entry, high construction, without adapter ¹⁾					CFV 10.21	21	MFV 10.32	32
with pegs, top entry, high construction, without adapter ¹⁾					CFV 10.29	29	MFV 10.40	40
with pegs, frontal entry, high construction	CAF 10	16	MAF 10.20	20				
with pegs, frontal entry, high construction, without adapter ¹⁾	CFF 10	16	MFF 10.20	20				

¹⁾ enclosure without adapter, threaded on the body, to be used only with a complete cable gland.

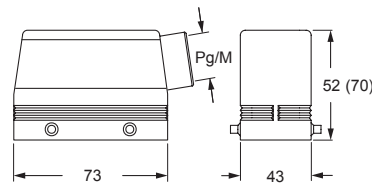
²⁾ can only be used with a complete cable gland (to be purchased separately).

IP degrees are according to the type of lever of the counterpart enclosures.

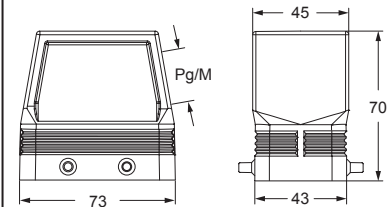
Alternatively, hoods with pegs may be coupled with fixed enclosures:

- C-TYPE, IP65 or IP66/IP69 stainless steel lever, from page 393 to page 400
- C7, IP66/IP67/IP69 stainless steel lever, page 438
- CV, IP65 or IP66/IP69 stainless steel lever, page 448 and 449

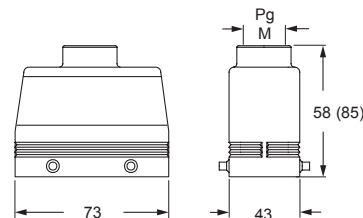
CHO (CAO) and MHO (MAO)



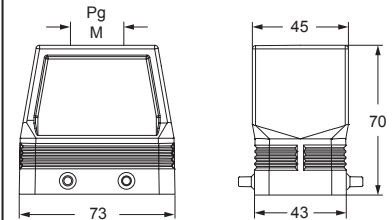
CFO and MFO



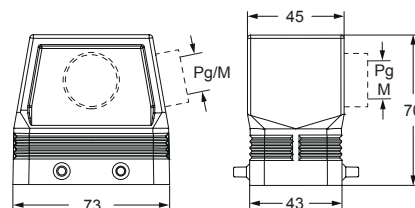
CHV (CAV) and MHV (MAV)



CFV and MFV



CAF/CFF and MAF/MFF



CALUS® Type 4/4X/12

insulating cable gland or fittings without gasket

cable gland with O-Ring gasket
IP67 if hoods without adapters coupled with IP67 housings

CH - CA - CF and MH - MA - MF C-TYPE standard version

inserts		page:
CDD	42 poles + ⊕	78
CDS	18 poles + ⊕	-
CDSH	18 poles + ⊕	87
CNE	10 poles + ⊕	111
CSE	10 poles + ⊕	-
CSH	10 poles + ⊕	111
CSH S	10 poles + ⊕	123
CCE	10 poles + ⊕	131
CMSH	3+2 (aux) poles + ⊕	136
CMCE	3+2 (aux) poles + ⊕	137
CSS	10 poles + ⊕	149
CQE	18 poles + ⊕	169
CX	8/24 poles + ⊕	194
MIXO	3 modules	262 - 317

hoods with 2 pegs



hoods with 2 pegs
M40 cable entry with 20 mm thread length



description	part No.	entry Pg	part No.	entry M	part No.	entry Pg	part No.	entry M
with pegs, side entry	CHO 10 L	16	MHO 10 L20	20				
with pegs, side entry			MHO 10 L25	25				
with pegs, side entry, high construction	CAO 10 L21	21	MAO 10 L32	32				
with pegs, side entry, high construction	CAO 10 L29	29	MAO 10 L40	40				
with pegs, side entry, high construction, without adapter 1)					CFO 10 L21	21	MFO 10 L32	32
with pegs, side entry, high construction, without adapter 1)					CFO 10 L29	29	MFO 10 L40	40
with pegs, top entry	CHV 10 L	16						
with pegs, top entry 2)			MHV 10 L20	20				
with pegs, top entry			MHV 10 L25	25				
with pegs, top entry, high construction	CAV 10 L21	21	MAV 10 L32	32				
with pegs, top entry, high construction	CAV 10 L29	29	MAV 10 L40	40				
with pegs, top entry, high construction, without adapter 1)					CFV 10 L21	21	MFV 10 L32	32
with pegs, top entry, high construction, without adapter 1)					CFV 10 L29	29	MFV 10 L40	40

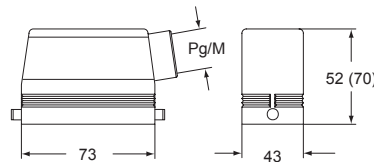
1) enclosure without adapter, threaded on the body, to be used only with a complete cable gland.

2) can only be used with a complete cable gland (to be purchased separately).

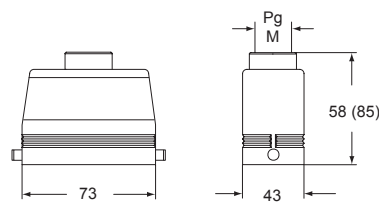
IP degrees are according to the type of lever of the counterpart enclosures. Alternatively, hoods with pegs may be coupled with fixed enclosures:

- C-TYPE, IP65 or IP66/IP69 stainless steel lever, from page 393 to page 400
- CV, IP65 or IP66/IP69 stainless steel lever, page 448 and 449

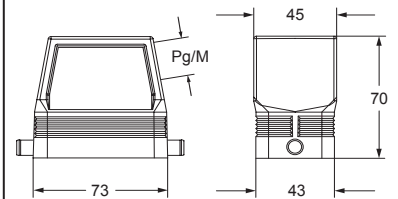
CHO L (CAO L) and MHO L (MAO L)



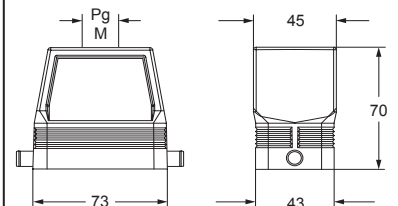
CHV L (CAV L) and MHV L (MAV L)




CFO L and MFO L




CFV L and MFV L



CAIUS® Type 4/4X/12

 insulating cable gland or fittings without gasket

 cable gland with O-Ring gasket

C-TYPE

CH - CF and MA - MF C-TYPE standard version

inserts		page:
CDD	42 poles + ⊕	78
CDS	18 poles + ⊕	-
CDSH	18 poles + ⊕	87
CNE	10 poles + ⊕	111
CSE	10 poles + ⊕	-
CSH	10 poles + ⊕	111
CSH S	10 poles + ⊕	123
CCE	10 poles + ⊕	131
CMSH	3+2 (aux) poles + ⊕	136
CMCE	3+2 (aux) poles + ⊕	137
CSS	10 poles + ⊕	149
CQE	18 poles + ⊕	169
CX	8/24 poles + ⊕	194
MIXO	3 modules	262 - 317

hoods with double top entry



description	part No.	entry Pg	part No.	entry M
with pegs for two levers used with enclosures size "57.27"	CAV 10.213	13,5 x 2	MAV 10.220	20 x 2
with pegs for two levers, without adapter 1) used with enclosures size "57.27"	CFV 10.213	13,5 x 2	MFV 10.220	20 x 2

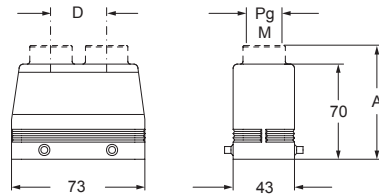
1) enclosure without adapter, threaded on the body, to be used only with a complete cable gland.

IP degrees are according to the type of lever of the counterpart enclosures.

Alternatively, hoods with pegs may be coupled with fixed enclosures:

- C-TYPE, IP65 or IP66/IP69 stainless steel lever, from page 393 to page 400
- C7, IP66/**IP67**/IP69 stainless steel lever, page 438
- CV, IP65 or IP66/IP69 stainless steel lever, page 448 and 449

CAV/CFV and MAV/MFV



part No.	A	B
CAV 10.213 - MAV 10.220	82 (84,5)	26 (28,5)
CFV 10.213 - MFV 10.220	-	28,5 (26)

CAV® Type 4/4X/12



insulating cable gland or fittings without gasket



cable gland with O-Ring gasket
IP67 if hoods without adapters coupled with IP67 housings

CH - CA - CF and MH - MA - MF C-TYPE standard version

inserts		page:
CDD	42 poles + ⊕	78
CDS	18 poles + ⊕	-
CDSH	18 poles + ⊕	87
CNE	10 poles + ⊕	111
CSE	10 poles + ⊕	-
CSH	10 poles + ⊕	111
CSH S	10 poles + ⊕	123
CCE	10 poles + ⊕	131
CMSH	3+2 (aux) poles + ⊕	136
CMCE	3+2 (aux) poles + ⊕	137
CSS	10 poles + ⊕	149
CQE	18 poles + ⊕	169
CX	8/24 poles + ⊕	194
MIXO	3 modules	262 - 317

hoods with 2 levers



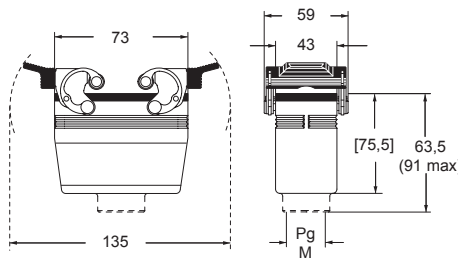
**hoods with 2 levers
M40 cable entry with 20 mm thread length**



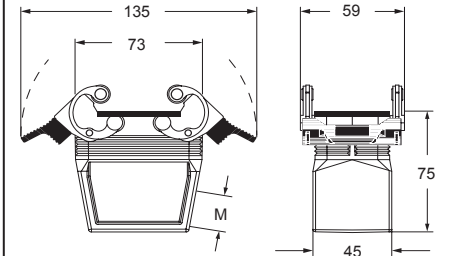
description	part No.	entry Pg	part No.	entry M	part No.	entry M
with levers and gasket, side entry, high construction, without adapter 1)					MFO 10 G40	40
with levers and gasket, top entry	CHV 10 G	16	MHV 10 G25	25		
with levers and gasket, top entry, high construction	CAV 10 G	21	MAV 10 G25	25		
with levers and gasket, top entry, high construction	CAV 10 G29	29	MAV 10 G32	32		
with levers and gasket, top entry, high construction, without adapter 1)	CFV 10 G	21	MFV 10 G25	25		
with levers and gasket, top entry, high construction, without adapter 1)	CFV 10 G29	29	MFV 10 G32	32		
with levers and gasket, top entry, high construction, without adapter 1)					MFV 10 G40	40

1) enclosure without adapter, threaded on the body, to be used only with a complete cable gland.

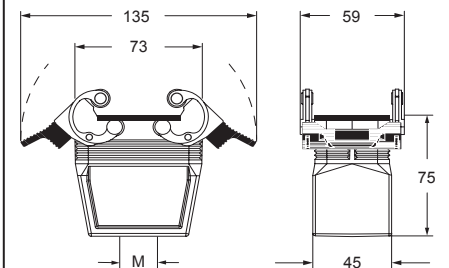
**CHV G (CAV G) and [CFV G],
MHV G (MAV G) and [MFV G]**




MFO 10 G40




MFV 10 G40



CAIUS® Type 4/4X/12

 insulating cable gland or fittings without gasket

 cable gland with O-Ring gasket

C-TYPE

CH - CA - CF and MH - MA - MF C-TYPE standard version

inserts		page:
CDD	42 poles + ⊕	78
CDS	18 poles + ⊕	-
CDSH	18 poles + ⊕	87
CNE	10 poles + ⊕	111
CSE	10 poles + ⊕	-
CSH	10 poles + ⊕	111
CSH S	10 poles + ⊕	123
CCE	10 poles + ⊕	131
CMSH	3+2 (aux) poles + ⊕	136
CMCE	3+2 (aux) poles + ⊕	137
CSS	10 poles + ⊕	149
CQE	18 poles + ⊕	169
CX	8/24 poles + ⊕	194
MIXO	3 modules	262 - 317

hoods with 1 lever



hoods with 1 lever

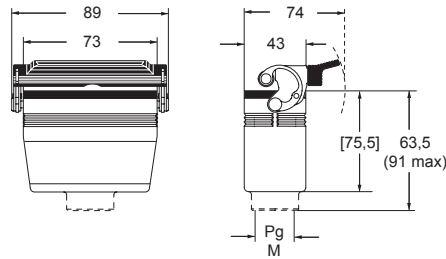
M40 cable entry with 20 mm thread length



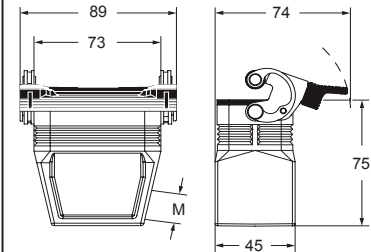
description	part No.	entry Pg	part No.	entry M	part No.	entry M
with lever and gasket, side entry, high construction, without adapter ¹⁾					MFO 10 LG40	40
with lever and gasket, top entry	CHV 10 LG	16	MHV 10 LG25	25		
with lever and gasket, top entry, high construction	CAV 10 LG21	21	MAV 10 LG25	25		
with lever and gasket, top entry, high construction	CAV 10 LG29	29	MAV 10 LG32	32		
with lever and gasket, top entry, high construction, without adapter ¹⁾	CFV 10 LG21	21	MFV 10 LG25	25		
with lever and gasket, top entry, high construction, without adapter ¹⁾	CFV 10 LG29	29	MFV 10 LG32	32		
with lever and gasket, top entry, high construction, without adapter ¹⁾					MFV 10 LG40	40

¹⁾ enclosure without adapter, threaded on the body, to be used only with a complete cable gland.

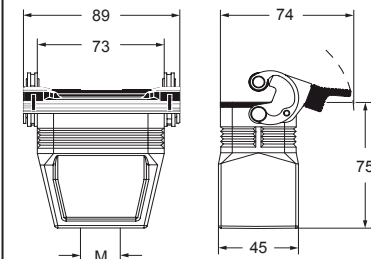
CHV LG (CAV LG) and [CFV LG], MHV LG (MAV LG) and [MFV LG]



MFO 10 LG40



MFV 10 LG40



CAIUS® Type 4/4X/12

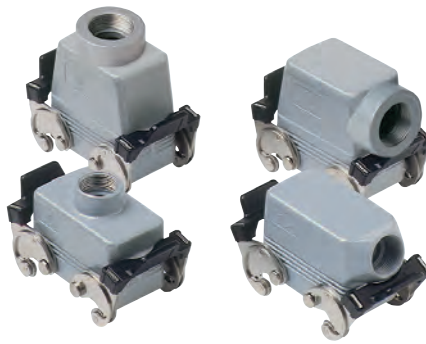
insulating cable gland or fittings without gasket

cable gland with O-Ring gasket

CH - CA and MH - MA C-TYPE standard version

inserts		page:
CDD	42 poles + ⊕	78
CDS	18 poles + ⊕	-
CDSH	18 poles + ⊕	87
CNE	10 poles + ⊕	111
CSE	10 poles + ⊕	-
CSH	10 poles + ⊕	111
CSH S	10 poles + ⊕	123
CCE	10 poles + ⊕	131
CMSH	3+2 (aux) poles + ⊕	136
CMCE	3+2 (aux) poles + ⊕	137
CSS	10 poles + ⊕	149
CQE	18 poles + ⊕	169
CX	8/24 poles + ⊕	194
MIXO	3 modules	262 - 317

hoods with 2 levers



covers



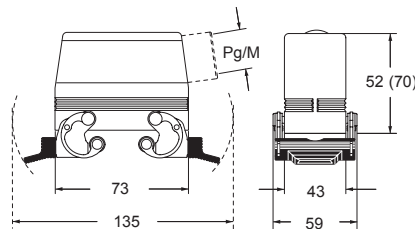
description	part No.	entry Pg	part No.	entry M	part No. (with eyelet)	part No. (with loop)
with levers, side entry ¹⁾	CHO 10 X	16	MHO 10 X20	20		
with levers, side entry ¹⁾			MHO 10 X25	25		
with levers, side entry, high construction ¹⁾	CAO 10 X	21	MAO 10 X32	32		
with levers, side entry, high construction ¹⁾	CAO 10 X29	29	MAO 10 X40	40		
with levers, top entry ¹⁾	CHV 10 X	16	MHV 10 X20	20		
with levers, top entry ³⁾			MHV 10 X25	25		
with levers, top entry ¹⁾			MAV 10 X32	32		
with levers, top entry, high construction ¹⁾	CAV 10 X	21	MAV 10 X40	40		
with levers, top entry, high construction ¹⁾	CAV 10 X29	29				
with 4 pegs (for enclosures with 2 levers with gasket)					CHC 10	CHC 10 S
with 4 pegs and gasket (for enclosures with 2 levers) ²⁾						CHC 10 C
with 2 pegs (for enclosures with 1 lever with gasket)					CHC 10 L	CHC 10 SL
with 2 levers (for hoods with 4 pegs)						CHC 10 G
with 1 lever (for hoods with 2 pegs)						CHC 10 LG

¹⁾ may be combined with enclosures:
 - CHI/CHP/CAP 10 CS/CP/C
 - MHP/MAP 10 CS/CP

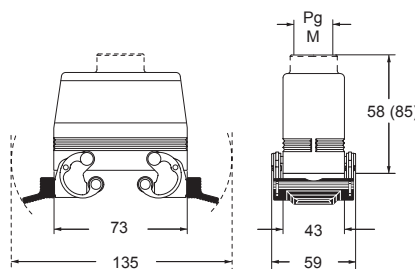
²⁾ may be combined with enclosures:
 - CHO/CAO 10 X and CHV/CAV 10 X
 - MHO/MAO 10 X and MHV/MAV 10 X

³⁾ can only be used with a complete cable gland (to be purchased separately).

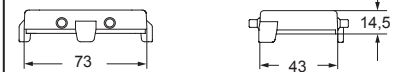
CHO X (CAO X) and MHO X (MAO X)



CHV X (CAV X) and MHV X (MAV X)



CHC (S)



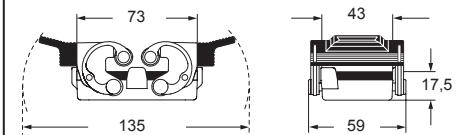
CHC C



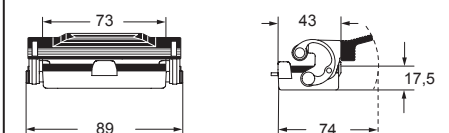
CHC L (SL)



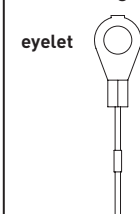
CHC G



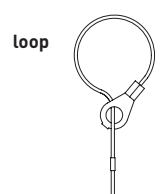
CHC LG



For fixing on housings



For fixing on hoods



CAIUS® Type 4/4X/12



insulating cable gland or fittings without gasket



cable gland with O-Ring gasket

CAC C-TYPE standard version

inserts		page:
CDD	42 poles + ⊕	78
CDS	18 poles + ⊕	-
CDSH	18 poles + ⊕	87
CNE	10 poles + ⊕	111
CSE	10 poles + ⊕	-
CSH	10 poles + ⊕	111
CSH S	10 poles + ⊕	123
CCE	10 poles + ⊕	131
CMSH	3+2 (aux) poles + ⊕	136
CMCE	3+2 (aux) poles + ⊕	137
CSS	10 poles + ⊕	149
CQE	18 poles + ⊕	169
CX	8/24 poles + ⊕	194
MIXO	3 modules	262 - 317

hoods without entry, to be drilled



hoods without entry, to be drilled



description	part No. (with 4 pegs)	part No. (with 2 pegs)
-------------	---------------------------	---------------------------

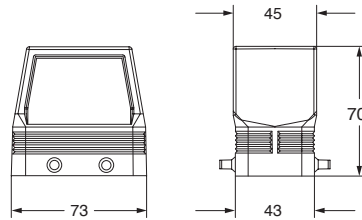
with pegs, high construction

CAC 10

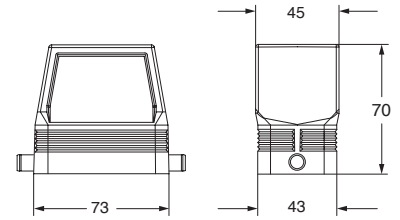
CAC 10 L

Alternatively, hoods with pegs are coupled with fixed enclosures:
 - C-TYPE, IP65 or IP66/IP69 stainless steel lever, from page 393 to page 400
 - C7, IP66/IP67/IP69 stainless steel lever, page 438
 - CV, IP65 or IP66/IP69 stainless steel lever, page 448 and 449

CAC 10 ●



CAC 10 L ▲



CAI[®] US Type 4/4X/12



● IP67 if coupled with IP67 housings

CH C-TYPE standard version

inserts		page:
CD	40 poles + ⊕	70
CDD	72 poles + ⊕	79
CDS	27 poles + ⊕	-
CDSH	27 poles + ⊕	88
CNE	16 poles + ⊕	112
CSE	16 poles + ⊕	-
CSH	16 poles + ⊕	112
CSH S	16 poles + ⊕	124
CCE	16 poles + ⊕	132
CMSH, CMCE	6+2 (aux) poles + ⊕	138 - 139
CSS	16 poles + ⊕	150
CT, CTS (10A *)	40 poles + ⊕	156
CT, CTSE (16A *)	16 poles + ⊕	162
CQE	32 poles + ⊕	170
CQEE	40 poles + ⊕	176
CP	6 poles + ⊕	178
CX	6/12, 6/36 and 12/2 poles + ⊕	197 - 199
CX	4/0 and 4/2 poles + ⊕	200 - 201
MIXO	4 modules	262 - 317

*) can be used only in bulkhead mounting housings

bulkhead mounting housings with 2 levers or 4 pegs



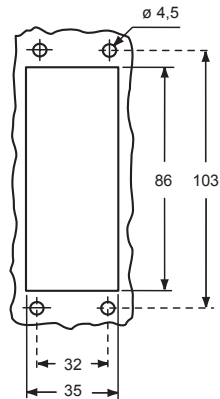
bulkhead mounting housings with single lever



description	part No.	part No.
with one or two levers	CHI 16	CHI 16 L
with pegs ¹⁾	CHI 16 C	
with pegs and aluminum cover ¹⁾	CHI 16 CS	
with pegs and plastic cover ¹⁾	CHI 16 CP	
with lever and aluminum cover		CHI 16 LS

¹⁾ may be combined with enclosures:
 - CHO/CAO 16 X and CHV/CAV 16 X
 - MHO/MAO 16 X and MHV/MAV 16 X

panel cut-out for bulkhead mounting housings



Q IMPORTANT NOTE: The enclosures ensure IP66/IP69 degree of protection (or IP65 for hinged cover versions) when mated and locked with the closing levers. The cover (CS, CP) only ensures mechanical protection, but does not ensure IP65 degree of protection.

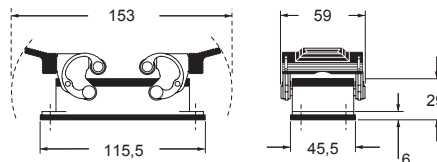
CR CLK
locking device for
CLASS locking levers
(page 666)



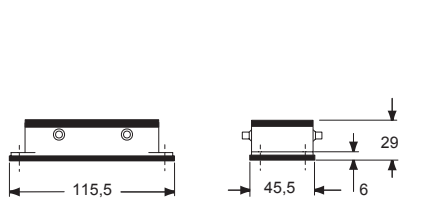
CAUS® Type
4/4X/12
(except enclosures with plastic cover)



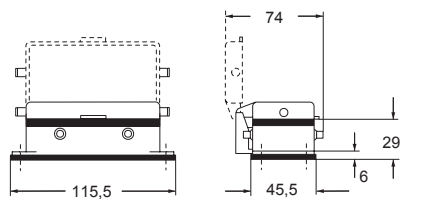
CHI ▲



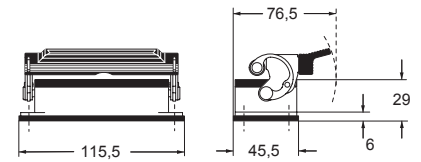
CHI C ▲



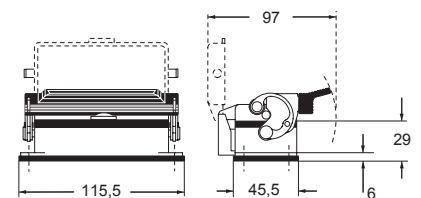
CHI CS/CP ●



CHI L ▲



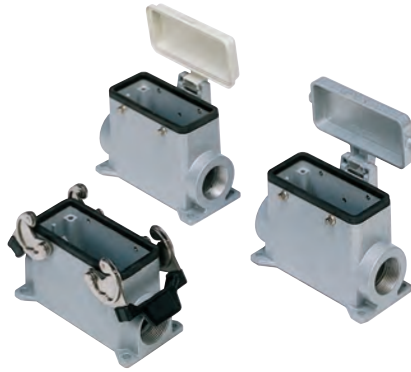
CHI LS ●



CH - CA and MH - MA C-TYPE standard version

inserts		page:
CD	40 poles + ⊕	70
CDD	72 poles + ⊕	79
CDS	27 poles + ⊕	-
CDSH	27 poles + ⊕	88
CNE	16 poles + ⊕	112
CSE	16 poles + ⊕	-
CSH	16 poles + ⊕	112
CSH S	16 poles + ⊕	124
CCE	16 poles + ⊕	132
CMSH, CMCE	6+2 (aux) poles + ⊕	138 - 139
CSS	16 poles + ⊕	150
CQE	32 poles + ⊕	170
CQEE	40 poles + ⊕	176
CP	6 poles + ⊕	178
CX	6/12, 6/36 and 12/2 poles + ⊕	197 - 199
CX	4/0 and 4/2 poles + ⊕	200 - 201
MIXO	4 modules	262 - 317

surface mounting housings with 2 levers or 4 pegs



surface mounting housings with single lever



description	part No.	entry Pg	part No.	entry M	part No.	entry Pg	part No.	entry M
with lever/s	CHP 16	21	MHP 16.25	25	CHP 16 L	21	MHP 16 L25	25
with lever/s	CHP 16.2	21 x 2	MHP 16.225	25 x 2	CHP 16 L2	21 x 2	MHP 16 L225	25 x 2
with levers, high construction 1)			MAP 16.25	25			MHP 16 L225	25 x 2
with levers, high construction 1)			MAP 16.225	25 x 2				
with lever/s, high construction	CAP 16.21	21	MAP 16.32	32	CAP 16 L	21	MAP 16 L32	32
with lever/s, high construction	CAP 16.221	21 x 2	MAP 16.232	32 x 2	CAP 16 L2	21 x 2	MAP 16 L232	32 x 2
with lever/s, high construction	CAP 16.29	29	MAP 16.40	40	CAP 16 L29	29	MAP 16 L40	40
with lever/s, high construction	CAP 16.229	29 x 2	MAP 16.240	40 x 2	CAP 16 L229	29 x 2	MAP 16 L240	40 x 2
with pegs and aluminum cover 2)	CHP 16 CS	21	MHP 16 CS25	25				
with pegs and aluminum cover 2)	CHP 16 CS2	21 x 2	MHP 16 CS225	25 x 2				
with pegs and aluminum cover, high construction 2)	CAP 16 CS	21	MAP 16 CS32	32				
with pegs and aluminum cover, high construction 2)	CAP 16 CS2	21 x 2	MAP 16 CS232	32 x 2				
with pegs and aluminum cover, high construction 2)	CAP 16 CS29	29	MAP 16 CS40	40				
with pegs and aluminum cover, high construction 2)	CAP 16 CS229	29 x 2	MAP 16 CS240	40 x 2				
with pegs and plastic cover 2)	CHP 16 CP	21	MHP 16 CP25	25				
with pegs and plastic cover 2)	CHP 16 CP2	21 x 2	MHP 16 CP225	25 x 2				
with pegs and plastic cover, high construction 2)	CAP 16 CP	21	MAP 16 CP32	32				
with pegs and plastic cover, high construction 2)	CAP 16 CP2	21 x 2	MAP 16 CP232	32 x 2				
with pegs and plastic cover, high construction 2)	CAP 16 CP29	29	MAP 16 CP40	40				
with pegs and plastic cover, high construction 2)	CAP 16 CP229	29 x 2	MAP 16 CP240	40 x 2				
with lever and aluminium cover					CHP 16 LS	21	MHP 16 LS25	25
with lever and aluminium cover					CHP 16 LS2	21 x 2	MHP 16 LS225	25 x 2
with lever and aluminium cover, high construction					CAP 16 LS	21	MAP 16 LS32	32
with lever and aluminium cover, high construction					CAP 16 LS2	21 x 2	MAP 16 LS232	32 x 2
with lever and aluminium cover, high construction					CAP 16 LS29	29	MAP 16 LS40	40
with lever and aluminium cover, high construction					CAP 16 LS229	29 x 2	MAP 16 LS240	40 x 2

1) can only be used with a complete cable gland (to be purchased separately)

2) may be combined with enclosures:
 - CHO/CAO 16 X and CHV/CAV 16 X
 - MHO/MAO 16 X and MHV/MAV 16 X

IMPORTANT NOTE: The enclosures ensure IP66/IP69 degree of protection (or IP65 for hinged cover versions) when mated and locked with the closing levers. The cover (CS, CP) only ensures mechanical protection, but does not ensure IP65 degree of protection.

CR CLK
locking device for CLASS locking levers (page 666)



CALUS Type 4/4X/12
(except enclosures with plastic cover)

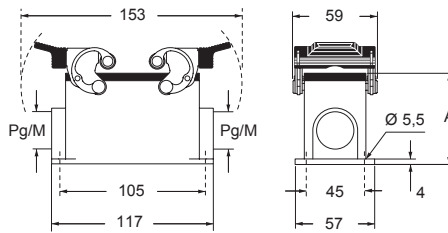


insulating cable gland or fittings without gasket

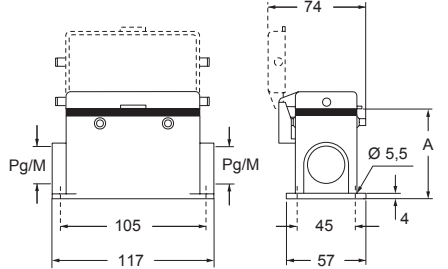


cable gland with O-Ring gasket

CHP - CAP and MHP - MAP ▲

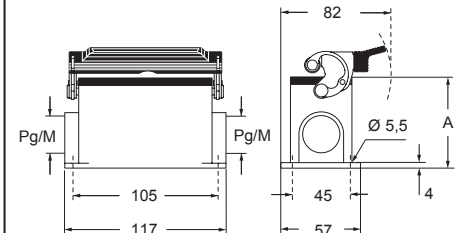


CHP CS/CP - CAP CS/CP and MHP CS/CP - MAP CS/CP ●

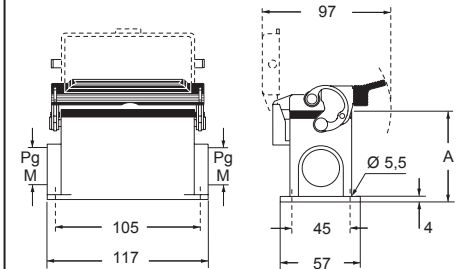


type	A
CHP / MHP	63
CAP / MAP	81
CHP CS / MHP CS	63
CAP CS / MAP CS	81
CHP CP / MHP CP	63
CAP CP / MAP CP	81

CHP L - CAP L and MHP L - MAP L ▲



CHP LS - CAP LS and MHP LS - MAP LS ●



type	A
CHP L / MHP L	63
CAP L / MAP L	81
CHP LS / MHP LS	63
CAP LS / MAP LS	81

CH - CA - CF and MH - MA - MF C-TYPE standard version

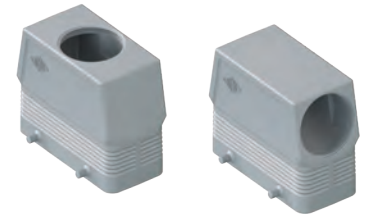
inserts		page:
CD	40 poles + ⊕	70
CDD	72 poles + ⊕	79
CDS	27 poles + ⊕	-
CDSH	27 poles + ⊕	88
CNE	16 poles + ⊕	112
CSE	16 poles + ⊕	-
CSH	16 poles + ⊕	112
CSH S	16 poles + ⊕	124
CCE	16 poles + ⊕	132
CMSH, CMCE	6+2 (aux) poles + ⊕	138 - 139
CSS	16 poles + ⊕	150
CQE	32 poles + ⊕	170
CQEE	40 poles + ⊕	176
CP	6 poles + ⊕	178
CX	6/12, 6/36 and 12/2 poles + ⊕	197 - 199
CX	4/0 and 4/2 poles + ⊕	200 - 201
MIXO	4 modules	262 - 317

hoods with 4 pegs



hoods with 4 pegs

M40 cable entry with 20 mm thread length



description	part No.	entry Pg	part No.	entry M	part No.	entry Pg	part No.	entry M
with pegs, side entry	CHO 16	21	MHO 16.25	25				
with pegs, side entry			MHO 16.32	32				
with pegs, side entry, high construction	CAO 16.21	21	MAO 16.32	32				
with pegs, side entry, high construction	CAO 16.29	29	MAO 16.40	40				
with pegs, side entry, high construction, without adapter 1)					CFO 16.21	21	MFO 16.32	32
with pegs, side entry, high construction, without adapter 1)					CFO 16.29	29	MFO 16.40	40
with pegs, top entry	CHV 16	21						
with pegs, top entry 2)			MHV 16.25	25				
with pegs, top entry			MHV 16.32	32				
with pegs, top entry, high construction	CAV 16.21	21	MAV 16.32	32				
with pegs, top entry, high construction	CAV 16.29	29	MAV 16.40	40				
with pegs, top entry, high construction, without adapter 1)					CFV 16.21	21	MFV 16.32	32
with pegs, top entry, high construction, without adapter 1)					CFV 16.29	29	MFV 16.40	40
with pegs, frontal entry, high construction	CAF 16	21	MAF 16.25	25				
with pegs, frontal entry, high construction, without adapter 1)	CFF 16	21	MFF 16.25	25				

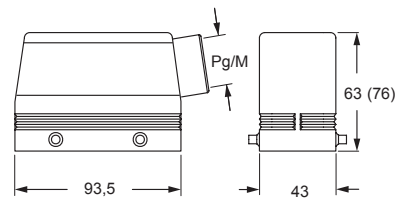
1) enclosure without adapter, threaded on the body, to be used only with a complete cable gland.

2) can only be used with a complete cable gland (to be purchased separately).

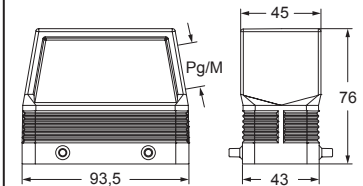
IP degrees are according to the type of lever of the counterpart enclosures.

- Alternatively, hoods with pegs may be coupled with fixed enclosures:
- C-TYPE, IP65 or IP66/IP69 stainless steel lever, from page 402 to page 410
 - C7, IP66/IP67/IP69 stainless steel lever, page 439
 - CV, IP65 or IP66/IP69 stainless steel lever, page 454 and 455.

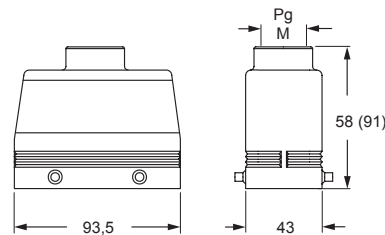
CHO (CAO) and MHO (MAO)



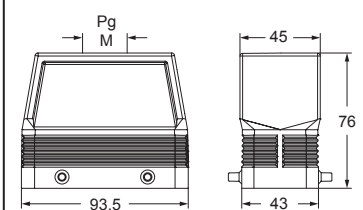
CFO and MFO



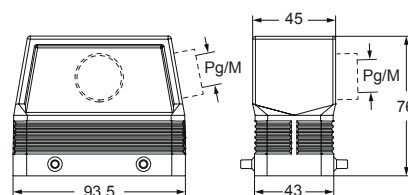
CHV (CAV) and MHV (MAV)



CFV and MFV



CAF/CFF and MAF/MFF



CALUS Type 4/4X/12



insulating cable gland or fittings without gasket



cable gland with O-Ring gasket
IP67 if hoods without adapters coupled with IP67 housings

CH - CA - CF and MH - MA - MF C-TYPE standard version

inserts		page:
CD	40 poles + ⊕	70
CDD	72 poles + ⊕	79
CDS	27 poles + ⊕	-
CDSH	27 poles + ⊕	88
CNE	16 poles + ⊕	112
CSE	16 poles + ⊕	-
CSH	16 poles + ⊕	112
CSH S	16 poles + ⊕	124
CCE	16 poles + ⊕	132
CMSH, CMCE	6+2 (aux) poles + ⊕	138 - 139
CSS	16 poles + ⊕	150
CQE	32 poles + ⊕	170
CQEE	40 poles + ⊕	176
CP	6 poles + ⊕	178
CX	6/12, 6/36 and 12/2 poles + ⊕	197 - 199
CX	4/0 and 4/2 poles + ⊕	200 - 201
MIXO	4 modules	262 - 317

hoods with 2 pegs



hoods with 2 pegs

M40 cable entry with 20 mm thread length



description	part No.	entry Pg	part No.	entry M	part No.	entry Pg	part No.	entry M
with pegs, side entry	CHO 16 L	21	MHO 16 L25	25				
with pegs, side entry			MHO 16 L32	32				
with pegs, side entry, high construction	CAO 16 L21	21	MAO 16 L32	32				
with pegs, side entry, high construction	CAO 16 L29	29	MAO 16 L40	40				
with pegs, side entry, high construction, without adapter ¹⁾					CFO 16 L21	21	MFO 16 L32	32
with pegs, side entry, high construction, without adapter ¹⁾					CFO 16 L29	29	MFO 16 L40	40
with pegs, top entry	CHV 16 L	21						
with pegs, top entry ²⁾			MHV 16 L25	25				
with pegs, top entry			MHV 16 L32	32				
with pegs, top entry, high construction	CAV 16 L21	21	MAV 16 L32	32				
with pegs, top entry, high construction	CAV 16 L29	29	MAV 16 L40	40				
with pegs, top entry, high construction, without adapter ¹⁾					CFV 16 L21	21	MFV 16 L32	32
with pegs, top entry, high construction, without adapter ¹⁾					CFV 16 L29	29	MFV 16 L40	40

¹⁾ enclosure without adapter, threaded on the body, to be used only with a complete cable gland.

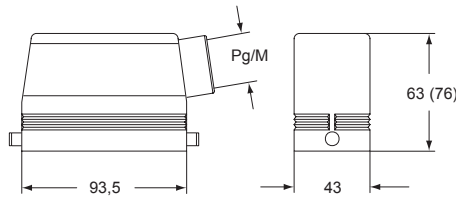
²⁾ can only be used with a complete cable gland (to be purchased separately).

IP degrees are according to the type of lever of the counterpart enclosures.

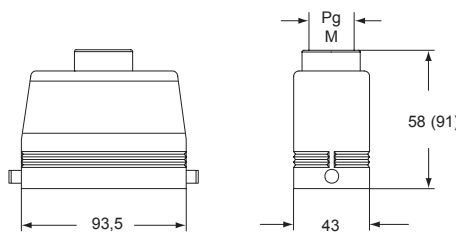
Alternatively, hoods with pegs may be coupled with fixed enclosures:

- C-TYPE, IP65 or IP66/IP69 stainless steel lever, from page 402 to page 410
- CV, IP65 or IP66/IP69 stainless steel lever, page 454 and 455

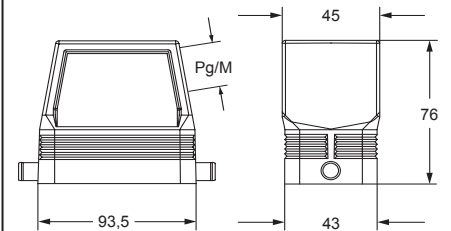
CHO L (CAO L) and MHO L (MAO L)



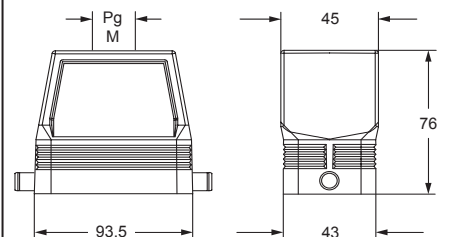
CHV L (CAV L) and MHV L (MAV L)



CFO L and MFO L



CFV L and MFV L



CAIUS® Type 4/4X/12

insulating cable gland or fittings without gasket

cable gland with O-Ring gasket

CA - CF and MA - MF C-TYPE standard version

inserts		page:
CD	40 poles + ⊕	70
CDD	72 poles + ⊕	79
CDS	27 poles + ⊕	-
CDSH	27 poles + ⊕	88
CNE	16 poles + ⊕	112
CSE	16 poles + ⊕	-
CSH	16 poles + ⊕	112
CSH S	16 poles + ⊕	124
CCE	16 poles + ⊕	132
CMSH, CMCE	6+2 (aux) poles + ⊕	138 - 139
CSS	16 poles + ⊕	150
CQE	32 poles + ⊕	170
CQEE	40 poles + ⊕	176
CP	6 poles + ⊕	178
CX	6/12, 6/36 and 12/2 poles + ⊕	197 - 199
CX	4/0 and 4/2 poles + ⊕	200 - 201
MIXO	4 modules	262 - 317

hoods with double top entry



hoods with double front entry

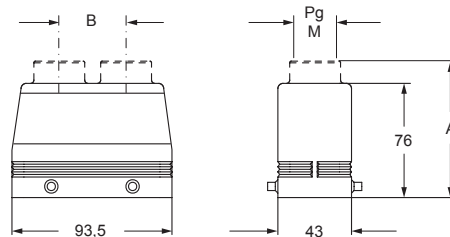


description	part No.	entry Pg	part No.	entry M	part No.	entry Pg	part No.	entry M
with pegs for two levers used with enclosures size "77.27"	CAV 16.216	16 x 2	MAV 16.220	20 x 2				
used with enclosures size "77.27"	CAV 16.221	21 x 2	MAV 16.225	25 x 2				
with pegs for 2 levers, without adapter 1) used with enclosures size "77.27"	CFV 16.216	16 x 2	MFV 16.220	20 x 2				
used with enclosures size "77.27"	CFV 16.221	21 x 2	MFV 16.225	25 x 2				
with pegs for two levers used with enclosures size "77.27"					CAF 16.221	21 x 2	MAF 16.225	25 x 2
with pegs for 2 levers, without adapter 1) used with enclosures size "77.27"					CAF 16.221	21 x 2	MAF 16.225	25 x 2

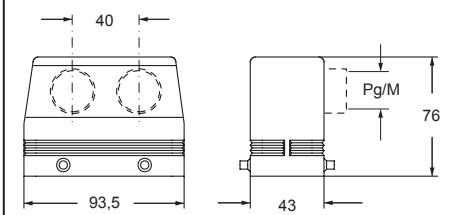
1) enclosure without adapter, threaded on the body, to be used only with a complete cable gland.

IP degrees are according to the type of lever of the counterpart enclosures.
Alternatively, hoods with pegs may be coupled with fixed enclosures:
- C-TYPE, IP65 or IP66/IP69 stainless steel lever, from page 402 to page 410
- C7, IP66/IP67/IP69 stainless steel lever, page 439
- CV, IP65 or IP66/IP69 stainless steel lever, page 454 and 455

CAV/CFV and MAV/MFV



CAF/CFF and MAF/MFF



part No.	A	B
CAV 16.216 - MAV 16.220	89 (90,5)	35 (30)
CAV 16.221 - MAV 16.225	90,5 (91)	40
CFV 16.216 - MFV 16.220	-	35 (30)
CFV 16.221 - MFV 16.225	-	40

CAIUS® Type 4/4X/12

insulating cable gland or fittings without gasket

cable gland with O-Ring gasket
IP67 if hoods without adapters coupled with IP67 housings

C-TYPE

CI and MI C-TYPE standard version

inserts		page:
CD	40 poles + ⊕	70
CDD	72 poles + ⊕	79
CDS	27 poles + ⊕	-
CDSH	27 poles + ⊕	88
CNE	16 poles + ⊕	112
CSE	16 poles + ⊕	-
CSH	16 poles + ⊕	112
CSH S	16 poles + ⊕	124
CCE	16 poles + ⊕	132
CMSH, CMCE	6+2 (aux) poles + ⊕	138 - 139
CSS	16 poles + ⊕	150
CQE	32 poles + ⊕	170
CQEE	40 poles + ⊕	176
CP	6 poles + ⊕	178
CX	6/12, 6/36 and 12/2 poles + ⊕	197 - 199
CX	4/0 and 4/2 poles + ⊕	200 - 201
MIXO	4 modules	262 - 317

inclined hoods for 2 levers with side entry



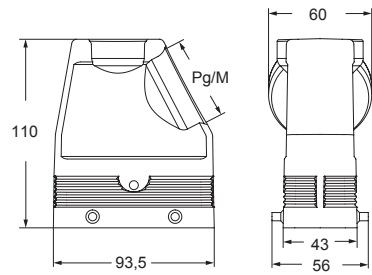
inclined hoods for 2 levers with top entry



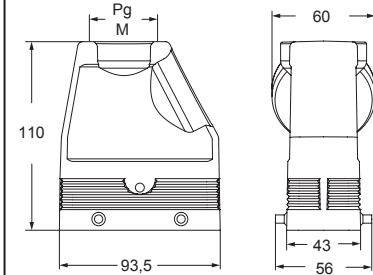
description	part No.	entry Pg	part No.	entry M	part No.	entry Pg	part No.	entry M
used with enclosures size "77.27" with pegs for two levers, side entry	CIO 16.36	36	MIO 16.40	40				
used with enclosures size "77.27" with pegs for two levers, side entry			MIO 16.50	50				
used with enclosures size "77.27" with pegs for two levers, top entry					CIV 16.29	29	MIV 16.40	40

IP degrees are according to the type of lever of the counterpart enclosures.
 Alternatively, hoods with pegs may be coupled with fixed enclosures:
 - C-TYPE, IP65 or IP66/IP69 stainless steel lever, from page 402 to page 410
 - C7, IP66/**IP67**/IP69 stainless steel lever, page 439
 - CV, IP65 or IP66/IP69 stainless steel lever, page 454 and 455

CIO and MIO



CIV and MIV



CAIUS® Type 4/4X/12

- insulating cable gland or fittings without gasket
- cable gland with O-Ring gasket according to the type of lever

CH - CA - CF and MH - MA - MF C-TYPE standard version

inserts		page:
CD	40 poles + ⊕	70
CDD	72 poles + ⊕	79
CDS	27 poles + ⊕	-
CDSH	27 poles + ⊕	88
CNE	16 poles + ⊕	112
CSE	16 poles + ⊕	-
CSH	16 poles + ⊕	112
CSH S	16 poles + ⊕	124
CCE	16 poles + ⊕	132
CMSH, CMCE	6+2 (aux) poles + ⊕	138 - 139
CSS	16 poles + ⊕	150
CQE	32 poles + ⊕	170
CQEE	40 poles + ⊕	176
CP	6 poles + ⊕	178
CX	6/12, 6/36 and 12/2 poles + ⊕	197 - 199
CX	4/0 and 4/2 poles + ⊕	200 - 201
MIXO	4 modules	262 - 317

hoods with 2 levers



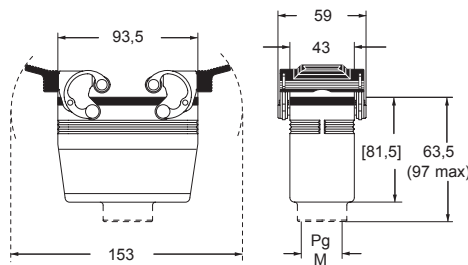
hoods with 2 levers
M40 cable entry with 20 mm thread length



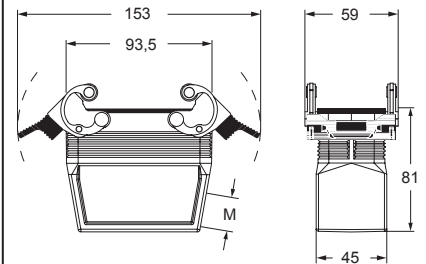
description	part No.	entry Pg	part No.	entry M	part No.	entry M
with levers and gasket, side entry, high construction, without adapter ¹⁾					MFO 16 G40	40
with levers and gasket, top entry	CHV 16 G	21	MHV 16 G32	32		
with levers and gasket, top entry, high construction	CAV 16 G	21	MAV 16 G25	25		
with levers and gasket, top entry, high construction	CAV 16 G29	29	MAV 16 G32	32		
with levers and gasket, top entry, high construction			MAV 16 G40	40		
with levers and gasket, top entry, high construction, without adapter ¹⁾	CFV 16 G	21	MFV 16 G25	25		
with levers and gasket, top entry, high construction, without adapter ¹⁾	CFV 16 G29	29	MFV 16 G32	32		
with levers and gasket, top entry, high construction, without adapter ¹⁾					MFV 16 G40	40

¹⁾ enclosure without adapter, threaded on the body, to be used only with a complete cable gland.

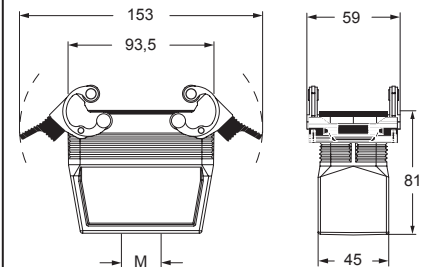
**CHV G (CAV G) and [CFV G],
MHV G (MAV G) and [MFV G]**




MFO 16 G40




MFV 16 G40



CAIUS® Type 4/4X/12

 insulating cable gland or fittings without gasket

 cable gland with O-Ring gasket

CH - CA - CF and MH - MA - MF C-TYPE standard version

inserts		page:
CD	40 poles + ⊕	70
CDD	72 poles + ⊕	79
CDS	27 poles + ⊕	-
CDSH	27 poles + ⊕	88
CNE	16 poles + ⊕	112
CSE	16 poles + ⊕	-
CSH	16 poles + ⊕	112
CSH S	16 poles + ⊕	124
CCE	16 poles + ⊕	132
CMSH, CMCE	6+2 (aux) poles + ⊕	138 - 139
CSS	16 poles + ⊕	150
CQE	32 poles + ⊕	170
CQEE	40 poles + ⊕	176
CP	6 poles + ⊕	178
CX	6/12, 6/36 and 12/2 poles + ⊕	197 - 199
CX	4/0 and 4/2 poles + ⊕	200 - 201
MIXO	4 modules	262 - 317

hoods with 1 lever



hoods with 1 lever

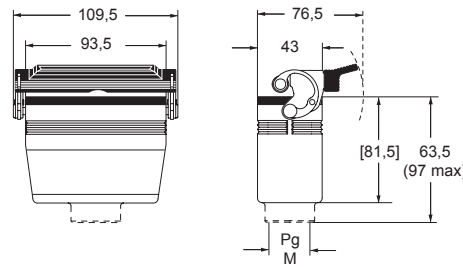
M40 cable entry with 20 mm thread length



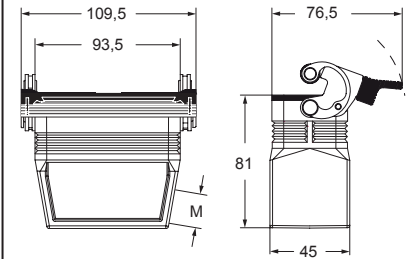
description	part No.	entry Pg	part No.	entry M	part No.	entry M
with lever and gasket, side entry, high construction, without adapter 1)					MFO 16 LG40	40
with lever and gasket, top entry	CHV 16 LG	21	MHV 16 LG32	32		
with lever and gasket, top entry, high construction	CAV 16 LG21	21	MAV 16 LG25	25		
with lever and gasket, top entry, high construction	CAV 16 LG29	29	MAV 16 LG32	32		
with lever and gasket, top entry, high construction			MAV 16 LG40	40		
with lever and gasket, top entry, high construction, without adapter 1)	CFV 16 LG21	21	MFV 16 LG25	25		
with lever and gasket, top entry, high construction, without adapter 1)	CFV 16 LG29	29	MFV 16 LG32	32		
with lever and gasket, top entry, high construction, without adapter 1)					MFV 16 LG40	40

1) enclosure without adapter, threaded on the body, to be used only with a complete cable gland.

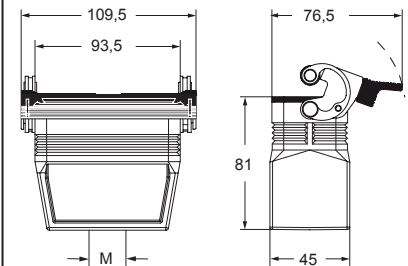
CHV LG (CAV LG) and [CFV LG], MHV LG (MAV LG) and [MFV LG]



MFO 10 LG40



MFV 10 LG40



CAIUS Type 4/4X/12

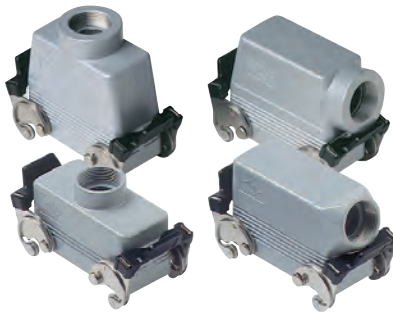
insulating cable gland or fittings without gasket

cable gland with O-Ring gasket

CH - CA and MH - MA C-TYPE standard version

inserts		page:
CD	40 poles + ⊕	70
CDD	72 poles + ⊕	79
CDS	27 poles + ⊕	-
CDSH	27 poles + ⊕	88
CNE	16 poles + ⊕	112
CSE	16 poles + ⊕	-
CSH	16 poles + ⊕	112
CSH S	16 poles + ⊕	124
CCE	16 poles + ⊕	132
CMSH, CMCE	6+2 (aux) poles + ⊕	138 - 139
CSS	16 poles + ⊕	150
CQE	32 poles + ⊕	170
CQEE	40 poles + ⊕	176
CP	6 poles + ⊕	178
CX	6/12, 6/36 and 12/2 poles + ⊕	197 - 199
CX	4/0 and 4/2 poles + ⊕	200 - 201
MIXO	4 modules	262 - 317

hoods with 2 levers



covers



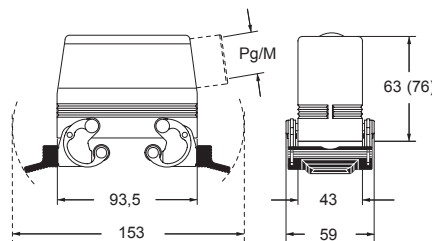
description	part No.	entry Pg	part No.	entry M	part No. (with eyelet)	part No. (with loop)
with levers, side entry ¹⁾	CHO 16 X	21	MHO 16 X25	25		
with levers, side entry ¹⁾			MHO 16 X32	32		
with levers, side entry, high construction ¹⁾	CAO 16 X	21	MAO 16 X32	32		
with levers, side entry, high construction ¹⁾	CAO 16 X29	29	MAO 16 X40	40		
with levers, top entry ¹⁾	CHV 16 X	21	MHV 16 X25	25		
with levers, top entry ^{1) 3)}			MHV 16 X32	32		
with levers, top entry ¹⁾			MHV 16 X32	32		
with levers, top entry, high construction ¹⁾	CAV 16 X	21	MAV 16 X32	32		
with levers, top entry, high construction ¹⁾	CAV 16 X29	29	MAV 16 X40	40		
with 4 pegs (for enclosures with 2 levers with gasket)					CHC 16	CHC 16 S
with 4 pegs and gasket (for enclosures with 2 levers) ²⁾						CHC 16 C
with 2 pegs (for enclosures with 1 lever with gasket)					CHC 16 L	CHC 16 SL
with 2 levers (for hoods with 4 pegs)						CHC 16 G
with 1 lever (for hoods with 2 pegs)						CHC 16 LG

¹⁾ may be combined with enclosures:
 - CHI/CHP/CAP 16 CS/CP/C
 - MHP/MAP 16 CS/CP

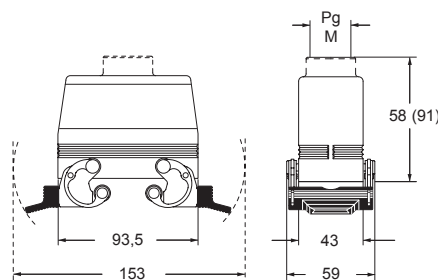
²⁾ may be combined with enclosures:
 - CHO/CAO 16 X and CHV/CAV 16 X
 - MHO/MAO 16 X and MHV/MAV 16 X

³⁾ can only be used with a complete cable gland (to be purchased separately).

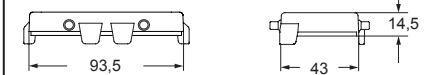
CHO X (CAO X) and MHO X (MAO X)



CHV X (CAV X) and MHV X (MAV X)



CHC (S)



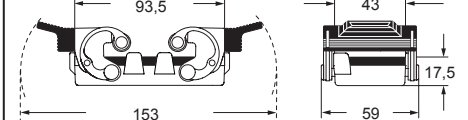
CHC C



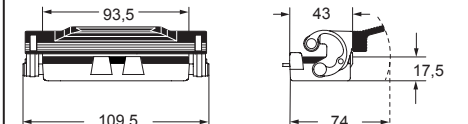
CHC L (SL)



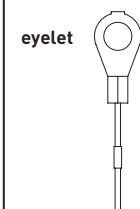
CHC G



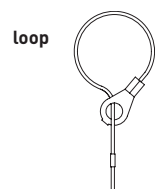
CHC LG




For fixing on housings




For fixing on hoods



CAIUS Type 4/4X/12

 insulating cable gland or fittings without gasket

 cable gland with O-Ring gasket

CAC C-TYPE standard version

inserts		page:
CD	40 poles + ⊕	70
CDD	72 poles + ⊕	79
CDS	27 poles + ⊕	-
CDSH	27 poles + ⊕	88
CNE	16 poles + ⊕	112
CSE	16 poles + ⊕	-
CSH	16 poles + ⊕	112
CSH S	16 poles + ⊕	124
CCE	16 poles + ⊕	132
CMSH, CMCE	6+2 (aux) poles + ⊕	138 - 139
CSS	16 poles + ⊕	150
CQE	32 poles + ⊕	170
CQEE	40 poles + ⊕	176
CP	6 poles + ⊕	178
CX	6/12, 6/36 and 12/2 poles + ⊕	197 - 199
CX	4/0 and 4/2 poles + ⊕	200 - 201
MIXO	4 modules	262 - 317

hoods without entry, to be drilled



hoods without entry, to be drilled



description	part No. (with 4 pegs)	part No. (with 2 pegs)
-------------	---------------------------	---------------------------

with pegs, high construction

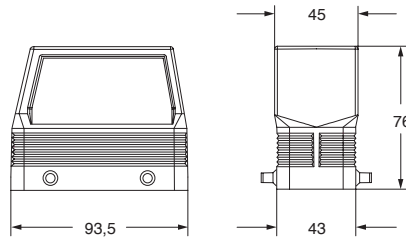
CAC 16

CAC 16 L

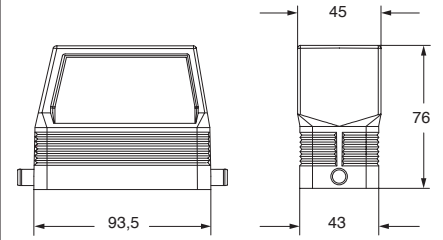
Alternatively, hoods with pegs may be coupled with fixed enclosures:

- C-TYPE, IP65 or IP66/IP69 stainless steel lever, from page 402 to page 410
- C7, IP66/IP67/IP69 stainless steel lever, page 439
- CV, IP65 or IP66/IP69 stainless steel lever, page 454 and 455

CAC 16 ●



CAC 16 L ▲



CAI[®] US Type 4/4X/12



● IP67 if coupled with IP67 housings

CH C-TYPE standard version

inserts		page:
CD	64 poles + ⊕	72
CDD	108 poles + ⊕	81
CDS	42 poles + ⊕	-
CDSH	42 poles + ⊕	89
CNE	24 poles + ⊕	113
CSE	24 poles + ⊕	-
CSH	24 poles + ⊕	113
CSH S	24 poles + ⊕	125
CCE	24 poles + ⊕	133
CMSH	10+2 (aux) poles + ⊕	140
CMCE	10+2 (aux) poles + ⊕	141
CSS	24 poles + ⊕	151
CT, CTS (10A) *)	64 poles + ⊕	157
CT, CTSE (16A) *)	24 poles + ⊕	163
CQE	46 poles + ⊕	171
CQEE	64 poles + ⊕	177
CX	4/8 and 6/6 poles + ⊕	204 and 206
MIXO	6 modules	262 - 317

*) can be used only in bulkhead mounting housings

bulkhead mounting housings with 2 levers or 4 pegs



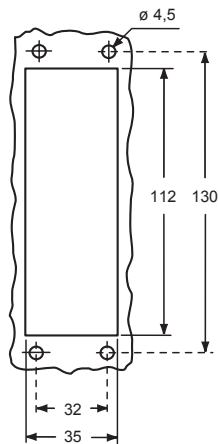
bulkhead mounting housings with single lever



description	part No.	part No.
with one or two levers	CHI 24	CHI 24 L
with pegs 1)	CHI 24 C	
with pegs and aluminum cover 1)	CHI 24 CS	
with pegs and plastic cover 1)	CHI 24 CP	
with lever and aluminum cover		CHI 24 LS

1) may be combined with enclosures:
 - CHO/CAO 24 X and CHV/CAV 24 X
 - MHO/MAO 24 X and MHV/MAV 24 X

panel cut-out for bulkhead mounting housings



IMPORTANT NOTE: The enclosures ensure IP66/IP69 degree of protection (or IP65 for hinged cover versions) when mated and locked with the closing levers. The cover (CS, CP) only ensures mechanical protection, but does not ensure IP65 degree of protection.

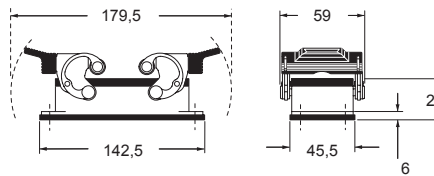
CR CLK
locking device for CLASS locking levers (page 666)



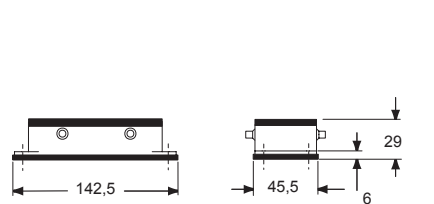
CAUS® Type 4/4X/12
(except enclosures with plastic cover)



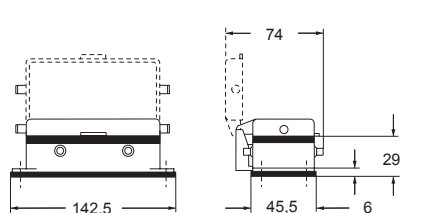
CHI ▲



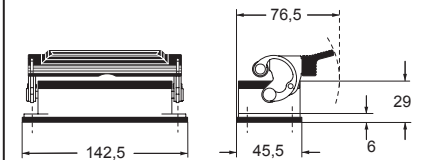
CHI C ▲



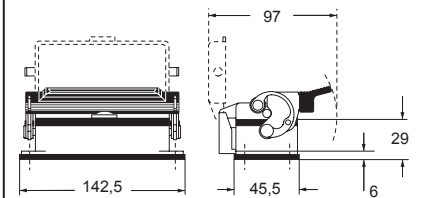
CHI CS/CP ●



CHI L ▲



CHI LS ●



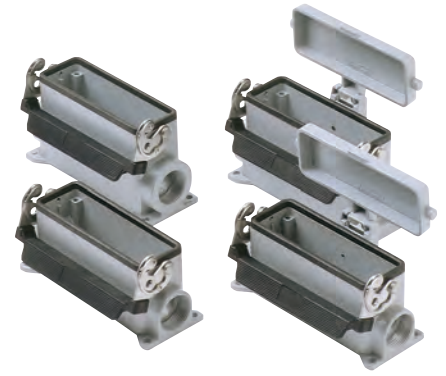
CH - CA and MH - MA C-TYPE standard version

inserts		page:
CD	64 poles + ⊕	72
CDD	108 poles + ⊕	81
CDS	42 poles + ⊕	-
CDSH	42 poles + ⊕	89
CNE	24 poles + ⊕	113
CSE	24 poles + ⊕	-
CSH	24 poles + ⊕	113
CSH S	24 poles + ⊕	125
CCE	24 poles + ⊕	133
CMSH	10+2 (aux) poles + ⊕	140
CMCE	10+2 (aux) poles + ⊕	141
CSS	24 poles + ⊕	151
CQE	46 poles + ⊕	171
CQEE	64 poles + ⊕	177
CX	4/8 and 6/6 poles + ⊕	204 and 206
MIXO	6 modules	262 - 317

surface mounting housings with 2 levers or 4 pegs



surface mounting housings with single lever



description	part No.	entry Pg	part No.	entry M	part No.	entry Pg	part No.	entry M
with lever/s	CHP 24	21	MHP 24.25	25	CHP 24 L	21	MHP 24 L25	25
with lever/s	CHP 24.2	21 x 2	MHP 24.225	25 x 2	CHP 24 L2	21 x 2	MHP 24 L225	25 x 2
with levers, high construction 1)			MAP 24.25	25				
with levers, high construction 1)			MAP 24.225	25 x 2				
with lever/s, high construction	CAP 24.21	21	MAP 24.32	32	CAP 24 L	21	MAP 24 L32	32
with lever/s, high construction	CAP 24.221	21 x 2	MAP 24.232	32 x 2	CAP 24 L2	21 x 2	MAP 24 L232	32 x 2
with lever/s, high construction	CAP 24.29	29	MAP 24.40	40	CAP 24 L29	29	MAP 24 L40	40
with lever/s, high construction	CAP 24.229	29 x 2	MAP 24.240	40 x 2	CAP 24 L229	29 x 2	MAP 24 L240	40 x 2
with pegs and aluminum cover 2)	CHP 24 CS	21	MHP 24 CS25	25				
with pegs and aluminum cover 2)	CHP 24 CS2	21 x 2	MHP 24 CS225	25 x 2				
with pegs and aluminum cover, high construction 2)	CAP 24 CS	21	MAP 24 CS32	32				
with pegs and aluminum cover, high construction 2)	CAP 24 CS2	21 x 2	MAP 24 CS232	32 x 2				
with pegs and aluminum cover, high construction 2)	CAP 24 CS29	29	MAP 24 CS40	40				
with pegs and aluminum cover, high construction 2)	CAP 24 CS229	29 x 2	MAP 24 CS240	40 x 2				
with pegs and plastic cover 2)	CHP 24 CP	21	MHP 24 CP25	25				
with pegs and plastic cover 2)	CHP 24 CP2	21 x 2	MHP 24 CP225	25 x 2				
with pegs and plastic cover, high construction 2)	CAP 24 CP	21	MAP 24 CP32	32				
with pegs and plastic cover, high construction 2)	CAP 24 CP2	21 x 2	MAP 24 CP232	32 x 2				
with pegs and plastic cover, high construction 2)	CAP 24 CP29	29	MAP 24 CP40	40				
with pegs and plastic cover, high construction 2)	CAP 24 CP229	29 x 2	MAP 24 CP240	40 x 2				
with lever and aluminium cover	CHP 24 LS	21	MHP 24 LS25	25				
with lever and aluminium cover	CHP 24 LS2	21 x 2	MHP 24 LS225	25 x 2				
with lever and aluminium cover, high construction	CAP 24 LS	21	MAP 24 LS32	32				
with lever and aluminium cover, high construction	CAP 24 LS2	21 x 2	MAP 24 LS232	32 x 2				
with lever and aluminium cover, high construction	CAP 24 LS29	29	MAP 24 LS40	40				
with lever and aluminium cover, high construction	CAP 24 LS229	29 x 2	MAP 24 LS240	40 x 2				

1) can only be used with a complete cable gland (to be purchased separately)

2) may be combined with enclosures:
 - CHO/CAO 24 X and CHV/CAV 24 X
 - MHO/MAO 24 X and MHV/MAV 24 X

IMPORTANT NOTE: The enclosures ensure IP66/IP69 degree of protection (or IP65 for hinged cover versions) when mated and locked with the closing levers. The cover (CS, CP) only ensures mechanical protection, but does not ensure IP65 degree of protection.

CR CLK
locking device for CLASS locking levers (page 666)



CAUS Type 4/4X/12
(except enclosures with plastic cover)

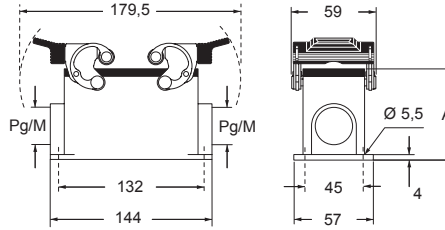


insulating cable gland or fittings without gasket

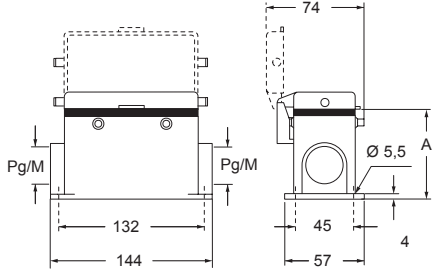


cable gland with O-Ring gasket

CHP - CAP and MHP - MAP ▲

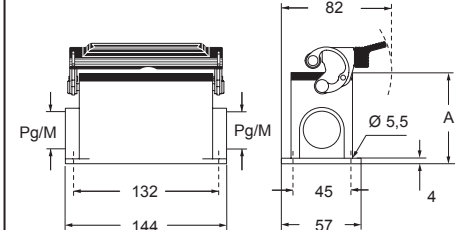


CHP CS/CP - CAP CS/CP and MHP CS/CP - MAP CS/CP ●

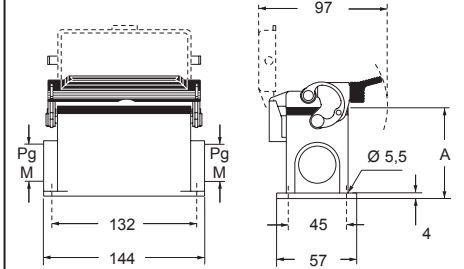


type	A
CHP / MHP	63
CAP / MAP	81
CHP CS / MHP CS	63
CAP CS / MAP CS	81
CHP CP / MHP CP	63
CAP CP / MAP CP	81

CHP L - CAP L and MHP L - MAP L ▲



CHP LS - CAP LS and MHP LS - MAP LS ●



type	A
CHP L / MHP L	63
CAP L / MAP L	81
CHP LS / MHP LS	63
CAP LS / MAP LS	81

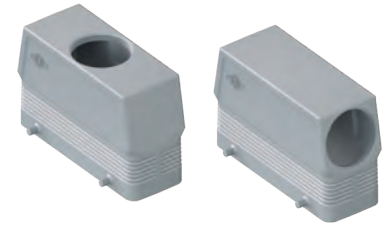
CH - CA - CF and MH - MA - MF C-TYPE standard version

inserts		page:
CD	64 poles + ⊕	72
CDD	108 poles + ⊕	81
CDS	42 poles + ⊕	-
CDSH	42 poles + ⊕	89
CNE	24 poles + ⊕	113
CSE	24 poles + ⊕	-
CSH	24 poles + ⊕	113
CSH S	24 poles + ⊕	125
CCE	24 poles + ⊕	133
CMSH	10+2 (aux) poles + ⊕	140
CMCE	10+2 (aux) poles + ⊕	141
CSS	24 poles + ⊕	151
CQE	46 poles + ⊕	171
CQEE	64 poles + ⊕	177
CX	4/8 and 6/6 poles + ⊕	204 and 206
MIXO	6 modules	262 - 317

hoods with 4 pegs



**hoods with 4 pegs
M40 cable entry with 20 mm thread length**



description	part No.	entry Pg	part No.	entry M	part No.	entry Pg	part No.	entry M
with pegs, side entry	CHO 24	21	MHO 24.25	25				
with pegs, side entry			MHO 24.32	32				
with pegs, side entry, high construction	CAO 24.21	21	MAO 24.32	32				
with pegs, side entry, high construction	CAO 24.29	29	MAO 24.40	40				
with pegs, side entry, high construction, without adapter 1)					CFO 24.21	21	MFO 24.32	32
with pegs, side entry, high construction, without adapter 1)					CFO 24.29	29	MFO 24.40	40
with pegs, top entry	CHV 24	21						
with pegs, top entry 2)			MHV 24.25	25				
with pegs, top entry			MHV 24.32	32				
with pegs, top entry	CHV 24.29	29	MHV 24.40	40				
with pegs, top entry, high construction	CAV 24.21	21	MAV 24.32	32				
with pegs, top entry, high construction	CAV 24.29	29	MAV 24.40	40				
with pegs, top entry, high construction, without adapter 1)					CFV 24.21	21	MFV 24.32	32
with pegs, top entry, high construction, without adapter 1)					CFV 24.29	29	MFV 24.40	40
with pegs, frontal entry, high construction	CAF 24.21	21	MAF 24.25	25				
with pegs, frontal entry, high construction	CAF 24.29	29	MAF 24.32	32				
with pegs, frontal entry, high construction, without adapter 1)	CFF 24.21	21	MFF 24.25	25				
with pegs, frontal entry, high construction, without adapter 1)	CFF 24.29	29	MFF 24.32	32				

1) enclosure without adapter, threaded on the body, to be used only with a complete cable gland.

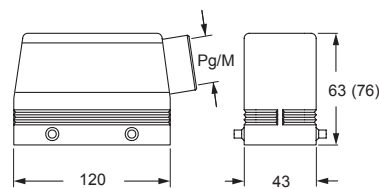
2) can only be used with a complete cable gland (to be purchased separately).

IP degrees are according to the type of lever of the counterpart enclosures.

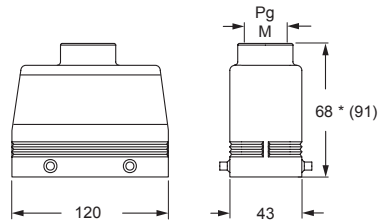
Alternatively, hoods with pegs may be coupled with fixed enclosures:

- C-TYPE, IP65 or IP66/IP69 stainless steel lever, from page 412 to page 422
- C7, IP66/IP67/IP69 stainless steel lever, page 441
- CV, IP65 or IP66/IP69 stainless steel lever, page 460 and 461

CHO (CAO) and MHO (MAO)

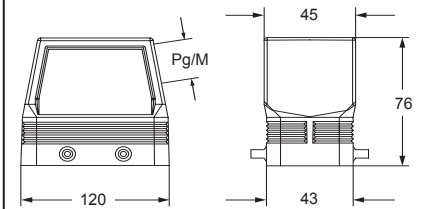


CHV (CAV) and MHV (MAV)

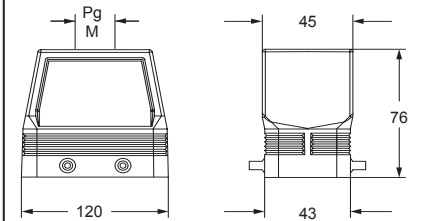


* 69,5 for Pg 29 - M40 versions

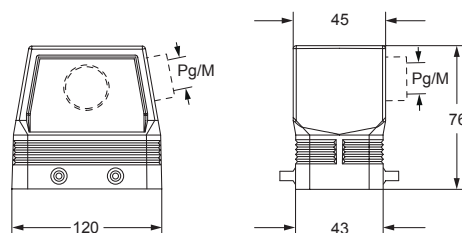
CFO and MFO



CFV and MFV



CAF/CFF and MAF/MFF



CALUS Type 4/4X/12



insulating cable gland or fittings without gasket



cable gland with O-Ring gasket
IP67 if hoods without adapters coupled with IP67 housings

CH - CA - CF and MH - MA - MF C-TYPE standard version

inserts		page:
CD	64 poles + ⊕	72
CDD	108 poles + ⊕	81
CDS	42 poles + ⊕	-
CDSH	42 poles + ⊕	89
CNE	24 poles + ⊕	113
CSE	24 poles + ⊕	-
CSH	24 poles + ⊕	113
CSH S	24 poles + ⊕	125
CCE	24 poles + ⊕	133
CMSH	10+2 (aux) poles + ⊕	140
CMCE	10+2 (aux) poles + ⊕	141
CSS	24 poles + ⊕	151
CQE	46 poles + ⊕	171
CQEE	64 poles + ⊕	177
CX	4/8 and 6/6 poles + ⊕	204 and 206
MIXO	6 modules	262 - 317

hoods with 2 pegs



hoods with 2 pegs M40 cable entry with 20 mm thread length



description	part No.	entry Pg	part No.	entry M	part No.	entry Pg	part No.	entry M
with pegs, side entry	CHO 24 L	21	MHO 24 L25	25				
with pegs, side entry			MHO 24 L32	32				
with pegs, side entry, high construction	CAO 24 L21	21	MAO 24 L32	32				
with pegs, side entry, high construction	CAO 24 L29	29	MAO 24 L40	40				
with pegs, side entry, high construction, without adapter ¹⁾					CFO 24 L21	21	MFO 24 L32	32
with pegs, side entry, high construction, without adapter ¹⁾					CFO 24 L29	29	MFO 24 L40	40
with pegs, top entry	CHV 24 L	21						
with pegs, top entry ²⁾			MHV 24 L25	25				
with pegs, top entry			MHV 24 L32	32				
with pegs, top entry	CHV 24 L29	29	MHV 24 L40	40				
with pegs, top entry, high construction	CAV 24 L21	21	MAV 24 L32	32				
with pegs, top entry, high construction	CAV 24 L29	29	MAV 24 L40	40				
with pegs, top entry, high construction, without adapter ¹⁾					CFV 24 L21	21	MFV 24 L32	32
with pegs, top entry, high construction, without adapter ¹⁾					CFV 24 L29	29	MFV 24 L40	40

¹⁾ enclosure without adapter, threaded on the body, to be used only with a complete cable gland.

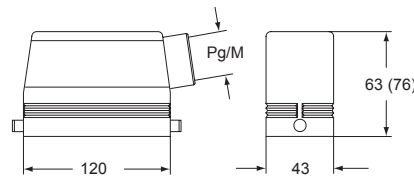
²⁾ can only be used with a complete cable gland (to be purchased separately).

IP degrees are according to the type of lever of the counterpart enclosures.

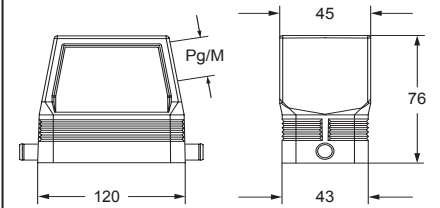
Alternatively, hoods with pegs may be coupled with fixed enclosures:

- C-TYPE, IP65 or IP66/IP69 stainless steel lever, from page 412 to page 422
- CV, IP65 or IP66/IP69 stainless steel lever, page 460 and 461

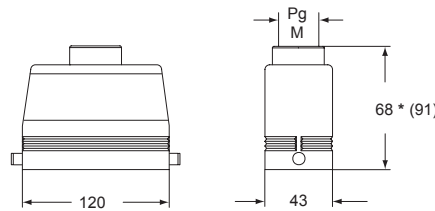
CHO L (CAO L) and MHO L (MAO L)



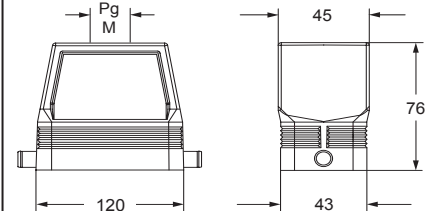
CFO L and MFO L



CHV L (CAV L) and MHV L (MAV L)



CFV L and MFV L



* 69,5 for Pg 29 - M40 versions

CRU® Type 4/4X/12

insulating cable gland or fittings without gasket

cable gland with O-Ring gasket

CA - CF and MA - MF C-TYPE standard version

inserts		page:
CD	64 poles + ⊕	72
CDD	108 poles + ⊕	81
CDS	42 poles + ⊕	-
CDSH	42 poles + ⊕	89
CNE	24 poles + ⊕	113
CSE	24 poles + ⊕	-
CSH	24 poles + ⊕	113
CSH S	24 poles + ⊕	125
CCE	24 poles + ⊕	133
CMSH	10+2 (aux) poles + ⊕	140
CMCE	10+2 (aux) poles + ⊕	141
CSS	24 poles + ⊕	151
CQE	46 poles + ⊕	171
CQEE	64 poles + ⊕	177
CX	4/8 and 6/6 poles + ⊕	204 and 206
MIXO	6 modules	262 - 317

hoods with double top entry and 4 pegs



hoods with double front entry and 4 pegs

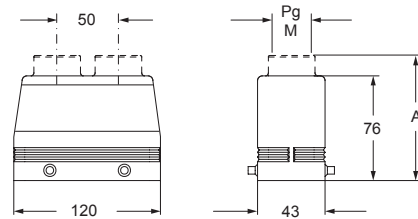


description	part No.	entry Pg	part No.	entry M	part No.	entry Pg	part No.	entry M
with pegs for two levers used with enclosures size "104.27"	CAV 24.221	21 x 2	MAV 24.232	32 x 2				
used with enclosures size "104.27"	CAV 24.229	29 x 2						
with pegs for 2 levers, without adapter 1) used with enclosures size "104.27"	CFV 24.221	21 x 2	MFV 24.232	32 x 2				
with pegs for two levers used with enclosures size "104.27"					CAF 24.221	21 x 2	MAF 24.225	25 x 2
with pegs for 2 lever, without adapter 1) used with enclosures size "104.27"					CFF 24.221	21 x 2	MFF 24.225	25 x 2

1) enclosure without adapter, threaded on the body, to be used only with a complete cable gland.

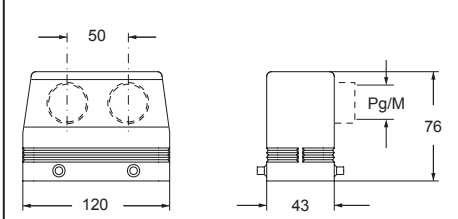
IP degrees are according to the type of lever of the counterpart enclosures.
Alternatively, hoods with pegs may be coupled with fixed enclosures:
- C-TYPE, IP65 or IP66/IP69 stainless steel lever, from page 412 to page 422
- C7, IP66/IP67/IP69 stainless steel lever, page 441
- CV, IP65 or IP66/IP69 stainless steel lever, page 460 and 461

CAV/CFV and MAV/MFV



part No.	A
CAV 24.221 - MAV 24.232	90,5 (91)
CAV 24.229	90,5
CFV 24.221 - MFV 24.232	-

CAF/CFF and MAF/MFF



CAU[®] US Type 4/4X/12



insulating cable gland or fittings without gasket



cable gland with O-Ring gasket
IP67 if hoods without adapters coupled with IP67 housings

CI and MI C-TYPE standard version

inserts		page:
CD	64 poles + ⊕	72
CDD	108 poles + ⊕	81
CDS	42 poles + ⊕	-
CDSH	42 poles + ⊕	89
CNE	24 poles + ⊕	113
CSE	24 poles + ⊕	-
CSH	24 poles + ⊕	113
CSH S	24 poles + ⊕	125
CCE	24 poles + ⊕	133
CMSH	10+2 (aux) poles + ⊕	140
CMCE	10+2 (aux) poles + ⊕	141
CSS	24 poles + ⊕	151
CQE	46 poles + ⊕	171
CQEE	64 poles + ⊕	177
CX	4/8 and 6/6 poles + ⊕	204 and 206
MIXO	6 modules	262 - 317

inclined hoods for 2 levers with side entry



inclined hoods for 2 levers with top entry



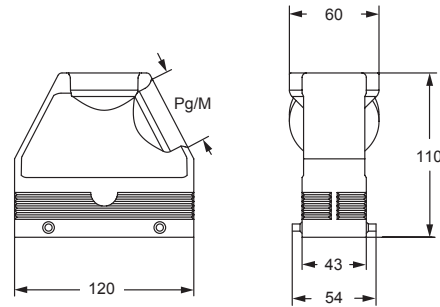
description	part No.	entry Pg	part No.	entry M	part No.	entry Pg	part No.	entry M
used with enclosures size "104.27" with pegs for two levers, side entry	CIO 24.36	36	MIO 24.40	40				
with pegs for two levers, side entry			MIO 24.50	50				
used with enclosures size "104.27" with pegs for two levers, top entry	CIV 24.36	36			MIV 24.40	40		
with pegs for two levers, top entry					MIV 24.50	50		

IP degrees are according to the type of lever of the counterpart enclosures.

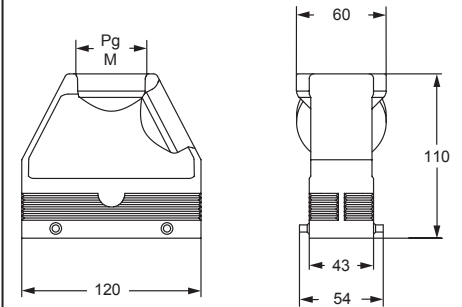
Alternatively, hoods with pegs may be coupled with fixed enclosures:

- C-TYPE, IP65 or IP66/IP69 stainless steel lever, from page 412 to page 422
- C7, IP66/IP67/IP69 stainless steel lever, page 441
- CV, IP65 or IP66/IP69 stainless steel lever, page 460 and 461

CIO and MIO



CIV and MIV



CAVUS® Type 4/4X/12

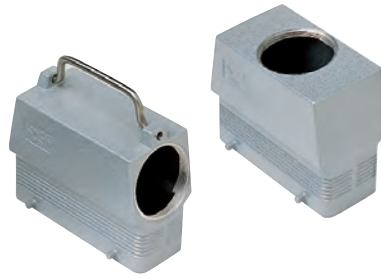
insulating cable gland or fittings without gasket

cable gland with O-Ring gasket according to the type of lever

CQ and MQ C-TYPE standard version

inserts		page:
CD	64 poles + ⊕	72
CDD	108 poles + ⊕	81
CDS	42 poles + ⊕	-
CDSH	42 poles + ⊕	89
CNE	24 poles + ⊕	113
CSE	24 poles + ⊕	-
CSH	24 poles + ⊕	113
CSH S	24 poles + ⊕	125
CCE	24 poles + ⊕	133
CMSH	10+2 (aux) poles + ⊕	140
CMCE	10+2 (aux) poles + ⊕	141
CSS	24 poles + ⊕	151
CQE	46 poles + ⊕	171
CQEE	64 poles + ⊕	177
CX	4/8 and 6/6 poles + ⊕	204 and 206
MIXO	6 modules	262 - 317

enlarged hoods,
side or top entry with 4 pegs



description	part No.	entry Pg	part No.	entry M
used with enclosures size "104.27"				
with pegs for two levers, side entry, without adapter 1)	CQO 24	36	MQO 24.40	40
with pegs for two levers, top entry, without adapter 1)	CQV 24	36	MQV 24.40	40

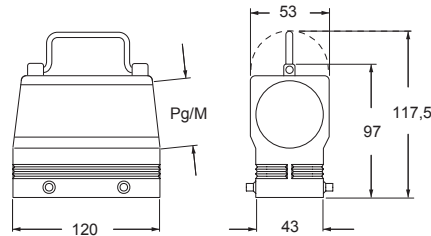
1) enclosure without adapter, threaded on the body, to be used only with a complete cable gland.

IP degrees are according to the type of lever of the counterpart enclosures.

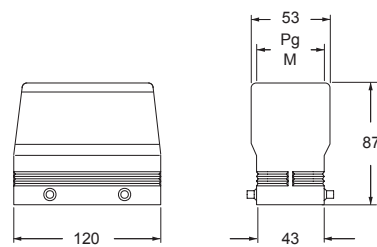
Alternatively, hoods with pegs may be coupled with fixed enclosures:

- C-TYPE, IP65 or IP66/IP69 stainless steel lever, from page 412 to page 422
- C7, IP66/IP67/IP69 stainless steel lever, page 441
- CV, IP65 or IP66/IP69 stainless steel lever, page 460 and 461


CQO and MQO




CQV and MQV



CAVUS® Type 4/4X/12

 insulating cable gland or fittings without gasket

 cable gland with O-Ring gasket according to the type of lever

C-TYPE

CH - CA - CF and MH - MA - MF C-TYPE standard version

inserts		page:
CD	64 poles + ⊕	72
CDD	108 poles + ⊕	81
CDS	42 poles + ⊕	-
CDSH	42 poles + ⊕	89
CNE	24 poles + ⊕	113
CSE	24 poles + ⊕	-
CSH	24 poles + ⊕	113
CSH S	24 poles + ⊕	125
CCE	24 poles + ⊕	133
CMSH	10+2 (aux) poles + ⊕	140
CMCE	10+2 (aux) poles + ⊕	141
CSS	24 poles + ⊕	151
CQE	46 poles + ⊕	171
CQEE	64 poles + ⊕	177
CX	4/8 and 6/6 poles + ⊕	204 and 206
MIXO	6 modules	262 - 317

hoods with 2 levers



hoods with 2 levers

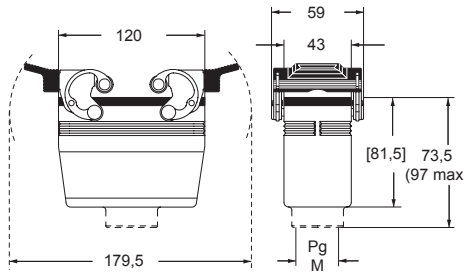
M40 cable entry with 20 mm thread length



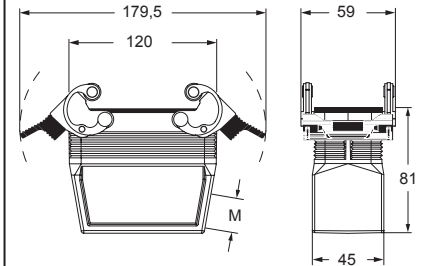
description	part No.	entry Pg	part No.	entry M	part No.	entry M
with levers and gasket, side entry, high construction, without adapter ¹⁾					MFO 24 G40	40
with levers and gasket, top entry	CHV 24 G	21	MHV 24 G32	32		
with levers and gasket, top entry, high construction	CAV 24 G	21	MAV 24 G25	25		
with levers and gasket, top entry, high construction	CAV 24 G29	29	MAV 24 G32	32		
with levers and gasket, top entry, high construction			MAV 24 G40	40		
with levers and gasket, top entry, high construction, without adapter ¹⁾	CFV 24 G	21	MFV 24 G25	25		
with levers and gasket, top entry, high construction, without adapter ¹⁾	CFV 24 G29	29	MFV 24 G32	32		
with levers and gasket, top entry, high construction, without adapter ¹⁾					MFV 24 G40	40

¹⁾ enclosure without adapter, threaded on the body, to be used only with a complete cable gland.

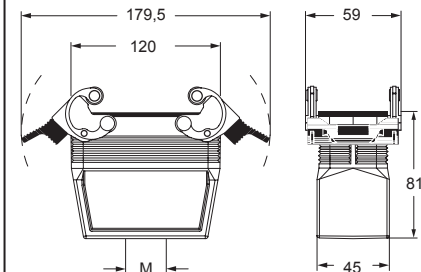
CHV G (CAV G) and [CFV G], MHV G (MAV G) and [MFV G]



MFO 24 G40



MFV 24 G40



CAIUS® Type 4/4X/12

insulating cable gland or fittings without gasket

cable gland with O-Ring gasket

CH - CA - CF and MH - MA - MF C-TYPE standard version

inserts		page:
CD	64 poles + ⊕	72
CDD	108 poles + ⊕	81
CDS	42 poles + ⊕	-
CDSH	42 poles + ⊕	89
CNE	24 poles + ⊕	113
CSE	24 poles + ⊕	-
CSH	24 poles + ⊕	113
CSH S	24 poles + ⊕	125
CCE	24 poles + ⊕	133
CMSH	10+2 (aux) poles + ⊕	140
CMCE	10+2 (aux) poles + ⊕	141
CSS	24 poles + ⊕	151
CQE	46 poles + ⊕	171
CQEE	64 poles + ⊕	177
CX	4/8 and 6/6 poles + ⊕	204 and 206
MIXO	6 modules	262 - 317

hoods with 1 lever



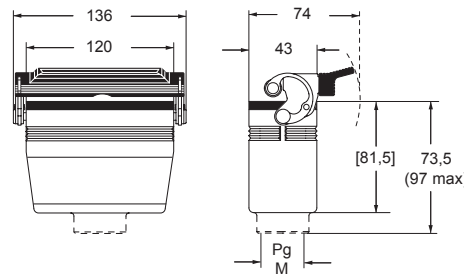
hoods with 1 lever M40 cable entry with 20 mm thread length



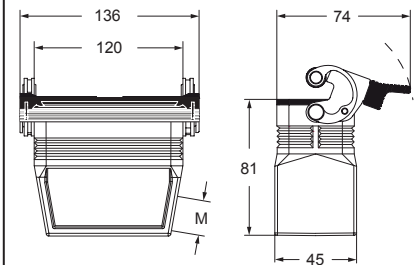
description	part No.	entry Pg	part No.	entry M	part No.	entry M
with lever and gasket, side entry, high construction, without adapter 1)					MFO 24 LG40	40
with lever and gasket, top entry	CHV 24 LG	21	MHV 24 LG32	32		
with lever and gasket, top entry, high construction	CAV 24 LG21	21	MAV 24 LG25	25		
with lever and gasket, top entry, high construction	CAV 24 LG29	29	MAV 24 LG32	32		
with lever and gasket, top entry, high construction			MAV 24 LG40	40		
with lever and gasket, top entry, high construction, without adapter 1)	CFV 24 LG21	21	MFV 24 LG25	25		
with lever and gasket, top entry, high construction, without adapter 1)	CFV 24 LG29	29	MFV 24 LG32	32		
with lever and gasket, top entry, high construction, without adapter 1)					MFV 24 LG40	40

1) enclosure without adapter, threaded on the body, to be used only with a complete cable gland.

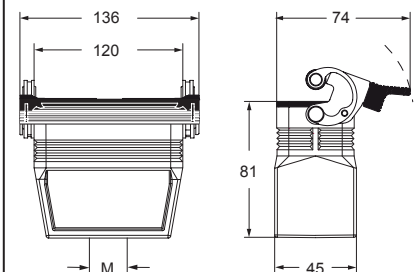
CHV LG (CAV LG) and [CFV LG], MHV LG (MAV LG) and [MFV LG]




MFO 24 LG40




MFV 24 LG40



CAIUS® Type 4/4X/12

 insulating cable gland or fittings without gasket

 cable gland with O-Ring gasket

C-TYPE

CAN C-TYPE standard version

inserts		page:
CD	64 poles + ⊕	72
CDD	108 poles + ⊕	81
CDS	42 poles + ⊕	-
CDSH	42 poles + ⊕	89
CNE	24 poles + ⊕	113
CSE	24 poles + ⊕	-
CSH	24 poles + ⊕	113
CSH S	24 poles + ⊕	125
CCE	24 poles + ⊕	133
CMSH	10+2 (aux) poles + ⊕	140
CMCE	10+2 (aux) poles + ⊕	141
CSS	24 poles + ⊕	151
CQE	46 poles + ⊕	171
CQEE	64 poles + ⊕	177
CX	4/8 and 6/6 poles + ⊕	204 and 206
MIXO	6 modules	262 - 317

hoods for ribbon cable with 4 pegs



gaskets for ribbon cable hood



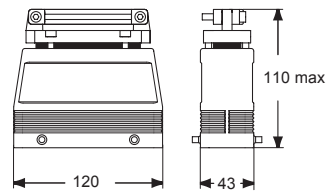
description	part No.	part No.
-------------	----------	----------

with pegs, top entry

CAN 24

ribbon cable seals (supplied separately)
 one slot for cable sizes 18,8 x 5,8 mm
 one slot for cable sizes 63,8 x 5,1 mm
 slot for cable sizes 36 x 9 mm
 not pre-drilled

CRN 1
CRN 2
CRN 3
CRN P



CAVUS® Type 4/4X/12

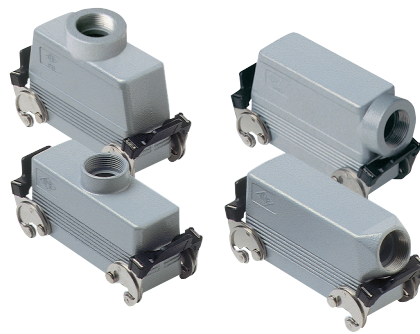


C-TYPE

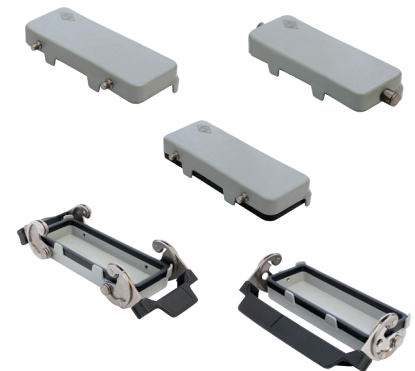
CH - CA and MH - MA C-TYPE standard version

inserts		page:
CD	64 poles + ⊕	72
CDD	108 poles + ⊕	81
CDS	42 poles + ⊕	-
CDSH	42 poles + ⊕	89
CNE	24 poles + ⊕	113
CSE	24 poles + ⊕	-
CSH	24 poles + ⊕	113
CSH S	24 poles + ⊕	125
CCE	24 poles + ⊕	133
CMSH	10+2 (aux) poles + ⊕	140
CMCE	10+2 (aux) poles + ⊕	141
CSS	24 poles + ⊕	151
CQE	46 poles + ⊕	171
CQEE	64 poles + ⊕	177
CX	4/8 and 6/6 poles + ⊕	204 and 206
MIXO	6 modules	262 - 317

hoods with 2 levers



covers



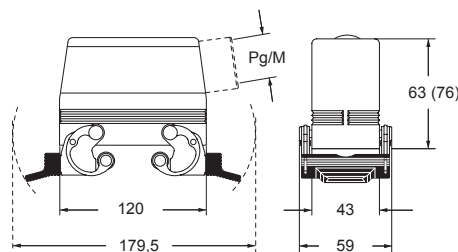
description	part No.	entry Pg	part No.	entry M	part No. (with eyelet)	part No. (with loop)
with levers, side entry ¹⁾	CHO 24 X	21	MHO 24 X25	25		
with levers, side entry ¹⁾			MHO 24 X32	32		
with levers, side entry, high construction ¹⁾	CAO 24 X	21	MAO 24 X32	32		
with levers, side entry, high construction ¹⁾	CAO 24 X29	29	MAO 24 X40	40		
with levers, top entry ¹⁾	CHV 24 X	21	MHV 24 X25	25		
with levers, top entry ^{1) 3)}			MHV 24 X32	32		
with levers, top entry ¹⁾			MAV 24 X32	32		
with levers, top entry, high construction ¹⁾	CAV 24 X	21	MAV 24 X40	40		
with levers, top entry, high construction ¹⁾	CAV 24 X29	29	MAV 24 X40	40		
with 4 pegs (for enclosures with 2 levers with gasket)					CHC 24	CHC 24 S
with 4 pegs and gasket (for enclosures with 2 levers) ²⁾						CHC 24 C
with 2 pegs (for enclosures with 1 lever with gasket)					CHC 24 L	CHC 24 SL
with 2 levers (for hoods with 4 pegs)						CHC 24 G
with 1 lever (for hoods with 2 pegs)						CHC 24 LG

¹⁾ may be combined with enclosures:
 - CHI/CHP/CAP 24 CS/CP/C
 - MHP/MAP 24 CS/CP

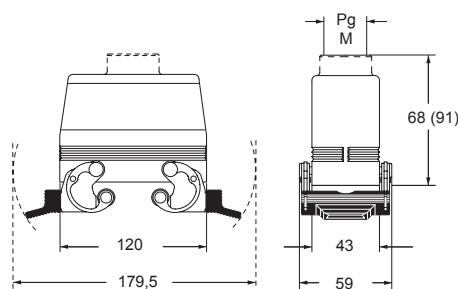
²⁾ may be combined with enclosures:
 - CHO/CAO 24 X and CHV/CAV 24 X
 - MHO/MAO 24 X and MHV/MAV 24 X

³⁾ can only be used with a complete cable gland (to be purchased separately).

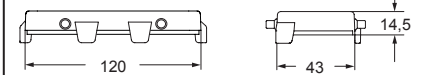
CHO X (CAO X) and MHO X (MAO X)



CHV X (CAV X) and MHV X (MAV X)



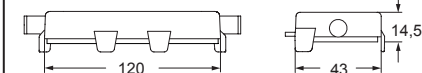
CHC (S)



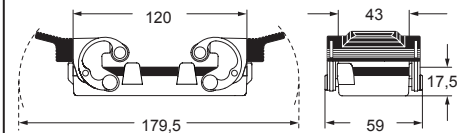
CHC C



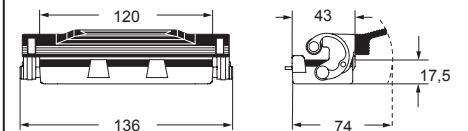
CHC L (SL)



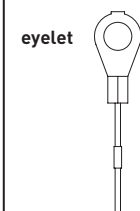
CHC G



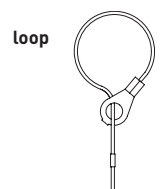
CHC LG




For fixing on housings




For fixing on hoods



CAIUS® Type 4/4X/12

 insulating cable gland or fittings without gasket

 cable gland with O-Ring gasket

C-TYPE

CAC C-TYPE standard version

inserts		page:
CD	64 poles + ⊕	72
CDD	108 poles + ⊕	81
CDS	42 poles + ⊕	-
CDSH	42 poles + ⊕	89
CNE	24 poles + ⊕	113
CSE	24 poles + ⊕	-
CSH	24 poles + ⊕	113
CSH S	24 poles + ⊕	125
CCE	24 poles + ⊕	133
CMSH	10+2 (aux) poles + ⊕	140
CMCE	10+2 (aux) poles + ⊕	141
CSS	24 poles + ⊕	151
CQE	46 poles + ⊕	171
CQEE	64 poles + ⊕	177
CX	4/8 and 6/6 poles + ⊕	204 and 206
MIXO	6 modules	262 - 317

hoods without entry, to be drilled



hoods without entry, to be drilled



description	part No. with 4 pegs	part No. with 2 pegs
-------------	-------------------------	-------------------------

with pegs, high construction

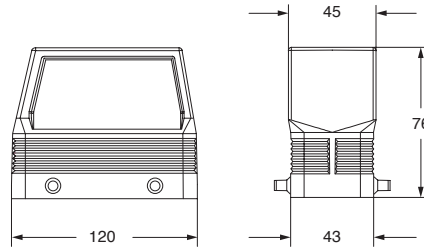
CAC 24

CAC 24 L

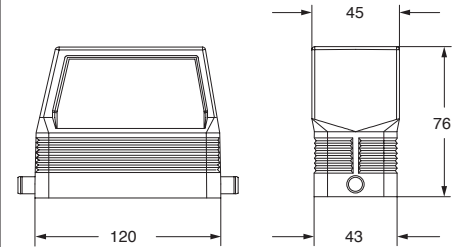
Alternatively, hoods with pegs may be coupled with fixed enclosures:

- C-TYPE, IP65 or IP66/IP69 stainless steel lever, from page 412 to page 422
- C7, IP66/IP67/IP69 stainless steel lever, page 441
- CV, IP65 or IP66/IP69 stainless steel lever, page 460 and 461

CAC 24 ●



CAC 24 L ▲



CAI[®] US Type 4/4X/12



● IP67 if coupled with IP67 housings

CH C-TYPE standard version

inserts		page:
CD	80 poles + ⊕	73
CDD	144 poles + ⊕	82
CDS	54 poles + ⊕	-
CDSH	54 poles + ⊕	90
CNE	32 poles + ⊕	114
CSE	32 poles + ⊕	-
CSH	32 poles + ⊕	114
CSH S	32 poles + ⊕	126
CCE	32 poles + ⊕	134
CSS	32 poles + ⊕	152
CTSE (16A) *)	32 poles + ⊕	164
CQE	64 poles + ⊕	172
CME	12+4 (aux) poles + ⊕	142
CMSH	12+4 (aux) poles + ⊕	142
CMCE	12+4 (aux) poles + ⊕	143
CP	12 poles + ⊕	179
MIXO	4 + 4 modules	262 - 317

*) can be used only in bulkhead mounting housings

insert dimensions:
2 x (77,5 x 27) mm

bulkhead mounting housings with 2 levers or 4 pegs



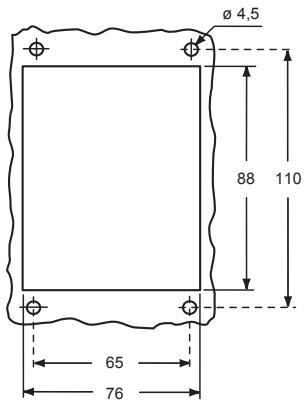
bulkhead mounting housings with single lever



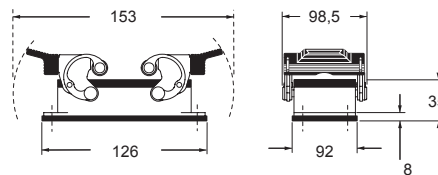
description	part No.	part No.
with one or two levers	CHI 32	CHI 32 L
with pegs and aluminium cover 1)	CHI 32 CS	
with lever and aluminium cover		CHI 32 LS

1) may be combined with enclosures:
- CHO/CHV/CFO/CFV 32 X
- MHO/MHV/MFO/MFV 32 X

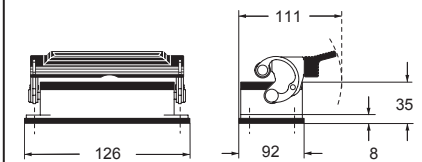
panel cut-out for bulkhead mounting housings



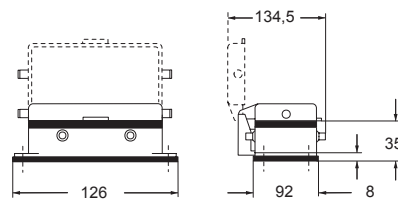
CHI ▲



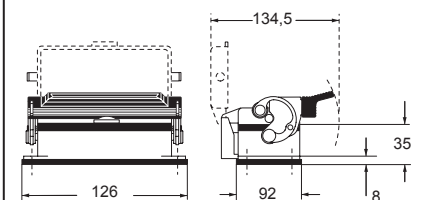
CHI L ▲



CHI CS ●



CHI LS ●



IMPORTANT NOTE: The enclosures ensure IP66/IP69 degree of protection (or IP65 for hinged cover versions) when mated and locked with the closing levers. The cover (CS, CP) only ensures mechanical protection, but does not ensure IP65 degree of protection.

CAUS Type 4/4X/12



C-TYPE

CH and MH C-TYPE standard version

inserts		page:
CD	80 poles + ⊕	73
CDD	144 poles + ⊕	82
CDS	54 poles + ⊕	-
CDSH	54 poles + ⊕	90
CNE	32 poles + ⊕	114
CSE	32 poles + ⊕	-
CSH	32 poles + ⊕	114
CSH S	32 poles + ⊕	126
CCE	32 poles + ⊕	134
CSS	32 poles + ⊕	152
CQE	64 poles + ⊕	172
CME	12+4 (aux) poles + ⊕	142
CMSH	12+4 (aux) poles + ⊕	142
CMCE	12+4 (aux) poles + ⊕	143
CP	12 poles + ⊕	179
MIXO	4 + 4 modules	262 - 317

insert dimensions:
2 x (77,5 x 27) mm

surface mounting housings with 2 levers



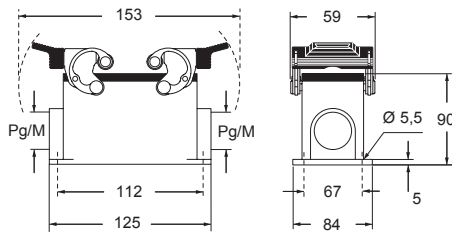
surface mounting housings with single lever



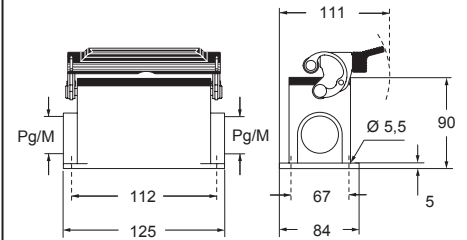
description	part No.	entry Pg	part No.	entry M	part No.	entry Pg	part No.	entry M
with one or two levers	CHP 32.29	29	MHP 32.40	40	CHP 32 L29	29	MHP 32 L40	40
with one or two levers	CHP 32.229	29 x 2	MHP 32.240	40 x 2	CHP 32 L229	29 x 2	MHP 32 L240	40 x 2
with one or two levers	CHP 32	36	MHP 32.50	50	CHP 32 L	36	MHP 32 L50	50
with one or two levers	CHP 32.2	36 x 2	MHP 32.250	50 x 2	CHP 32 L2	36 x 2	MHP 32 L250	50 x 2
with one or two levers	CHP 32.42	42			CHP 32 L42	42		
with one or two levers	CHP 32.242	42 x 2			CHP 32 L242	42 x 2		
with lever and aluminium cover					CHP 32 LS29	29	MHP 32 LS40	40
with lever and aluminium cover					CHP 32 LS229	29 x 2	MHP 32 LS240	40 x 2
with lever and aluminium cover					CHP 32 LS	36	MHP 32 LS50	50
with lever and aluminium cover					CHP 32 LS2	36 x 2	MHP 32 LS250	50 x 2
with lever and aluminium cover					CHP 32 LS42	42		
with lever and aluminium cover					CHP 32 LS242	42 x 2		

Q IMPORTANT NOTE: The enclosures ensure IP66/IP69 degree of protection (or IP65 for hinged cover versions) when mated and locked with the closing levers. The cover (CS, CP) only ensures mechanical protection, but does not ensure IP65 degree of protection.

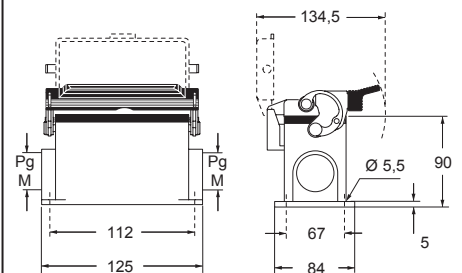
CHP and MHP ▲



CHP L and MHP L ▲



CHP LS and MHP LS ●



CAIUS Type 4/4X/12



● insulating cable gland or fittings without gasket



▲ cable gland with O-Ring gasket

CH - CF and MH - MF C-TYPE standard version

inserts		page:
CD	80 poles + ⊕	73
CDD	144 poles + ⊕	82
CDS	54 poles + ⊕	-
CDSH	54 poles + ⊕	90
CNE	32 poles + ⊕	114
CSE	32 poles + ⊕	-
CSH	32 poles + ⊕	114
CSH S	32 poles + ⊕	126
CCE	32 poles + ⊕	134
CSS	32 poles + ⊕	152
CQE	64 poles + ⊕	172
CME	12+4 (aux) poles + ⊕	142
CMSh	12+4 (aux) poles + ⊕	142
CMCE	12+4 (aux) poles + ⊕	143
CP	12 poles + ⊕	179
MIXO	4 + 4 modules	262 - 317

insert dimensions:
2 x (77,5 x 27) mm

hoods with 4 pegs and 2 levers



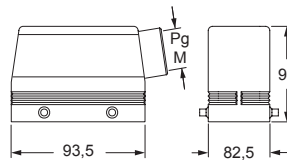
hoods with 2 pegs and 1 lever



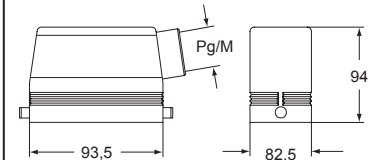
description	part No.	entry Pg	part No.	entry M	part No.	entry Pg	part No.	entry M
with pegs, side entry	CHO 32.29	29	MHO 32.32	32	CHO 32 L	36	MHO 32 L40	40
with pegs, side entry	CHO 32	36	MHO 32.40	40				
with pegs, side entry	CHO 32.42	42	MHO 32.50	50				
with pegs, side entry, without adapter 1)	CFO 32.29	29	MFO 32.32	32	CFO 32 L	36	MFO 32 L40	40
with pegs, side entry, without adapter 1)	CFO 32	36	MFO 32.40	40				
with pegs, side entry, without adapter 1)	CFO 32.42	42	MFO 32.50	50				
with pegs, top entry	CHV 32.29	29	MHV 32.32	32	CHV 32 L	36	MHV 32 L40	40
with pegs, top entry	CHV 32	36	MHV 32.40	40				
with pegs, top entry	CHV 32.42	42	MHV 32.50	50				
with pegs, top entry, without adapter 1)	CFV 32.29	29	MFV 32.32	32	CFV 32 L	36	MFV 32 L40	40
with pegs, top entry, without adapter 1)	CFV 32	36	MFV 32.40	40				
with pegs, top entry, without adapter 1)	CFV 32.42	42	MFV 32.50	50				
with levers and gasket, top entry	CHV 32 G29	29	MHV 32 G32	32	CHV 32 LG	36	MHV 32 LG40	40
with one or two levers and gasket, top entry	CHV 32 G	36	MHV 32 G40	40				
with levers and gasket, top entry	CHV 32 G42	42	MHV 32 G50	50				
with levers and gasket, top entry, without adapter 1)	CFV 32 G29	29	MFV 32 G32	32	CFV 32 LG	36	MFV 32 LG40	40
with lever/s and gasket, top entry, without adapter 1)	CFV 32 G	36	MFV 32 G40	40				
with levers and gasket, top entry, without adapter 1)	CFV 32 G42	42	MFV 32 G50	50				

1) enclosure without adapter, threaded on the body, to be used only with a complete cable gland.

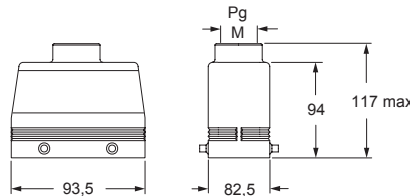
CHO/CFO and MHO/MFO



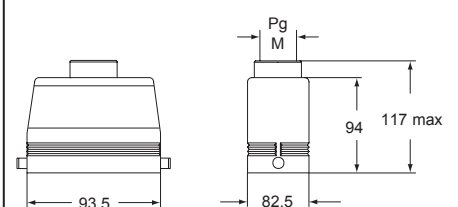
CHO/CFO L and MHO/MFO L



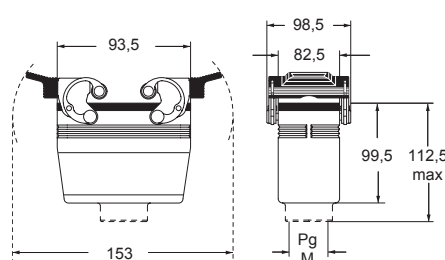
CHV/CFV and MHV/MFV



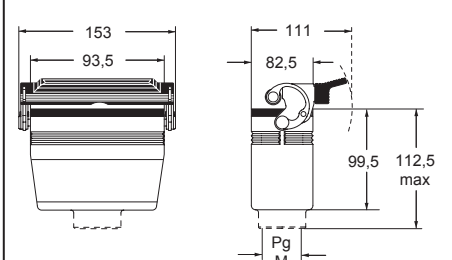
CHV/CFV L and MHV/MFV L



CHV/CFV G and MHV/MFV G



CHV/CFV LG and MHV/MFV LG



CAUS® Type 4/4X/12



insulating cable gland or fittings without gasket



cable gland with O-Ring gasket

CH - CF and MH - MF C-TYPE standard version

inserts		page:
CD	80 poles + ⊕	73
CDD	144 poles + ⊕	82
CDS	54 poles + ⊕	-
CDSH	54 poles + ⊕	90
CNE	32 poles + ⊕	114
CSE	32 poles + ⊕	-
CSH	32 poles + ⊕	114
CSH S	32 poles + ⊕	126
CCE	32 poles + ⊕	134
CSS	32 poles + ⊕	152
CQE	64 poles + ⊕	172
CME	12+4 (aux) poles + ⊕	142
CMSH	12+4 (aux) poles + ⊕	142
CMCE	12+4 (aux) poles + ⊕	143
CP	12 poles + ⊕	179
MIXO	4 + 4 modules	262 - 317

insert dimensions:
2 x (77,5 x 27) mm

hoods with 2 levers



covers



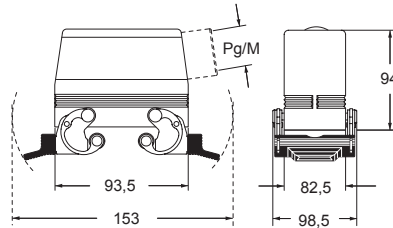
description	part No.	entry Pg	part No.	entry M	part No. (with eyelet)	part No. (with loop)
with levers, side entry ²⁾	CHO 32 X	36	MHO 32 X40	40		
with levers, side entry, without adaptor ^{1) 2)}	CFO 32 X	36	MFO 32 X40	40		
with levers, top entry ²⁾	CHV 32 X	36	MHV 32 X40	40		
with levers, top entry, without adaptor ^{1) 2)}	CFV 32 X	36	MFV 32 X40	40		
with 4 pegs (for enclosures with 2 levers with gasket)					CHC 32	CHC 32 S
with 4 pegs and gasket (for enclosures with 2 levers) ³⁾						CHC 32 C
with 2 pegs (for enclosures with 1 lever with gasket)					CHC 32 L	CHC 32 SL
with 2 levers (for hoods with 4 pegs)						CHC 32 G
with 1 lever (for hoods with 2 pegs)						CHC 32 LG

¹⁾ enclosure without adapter, threaded on the body, to be used only with a complete cable gland.

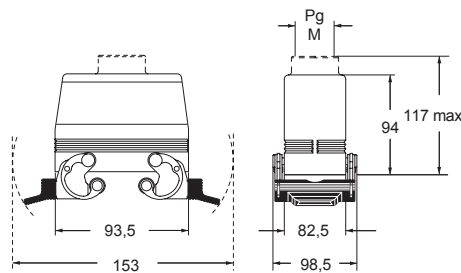
²⁾ may be combined with CHI 32 CS enclosures

³⁾ may be combined with enclosures:
- CHO/CFO 32 X and CHV/CFV 32 X
- MHO/MFO 32 X and MHV/MFV 32 X

CHO/CFO X and MHO/MFO X



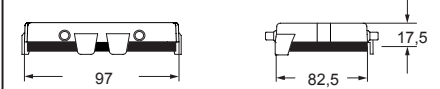
CHV/CFV X and MHV/MFV X



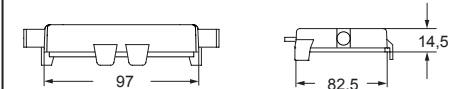
CHC (S)



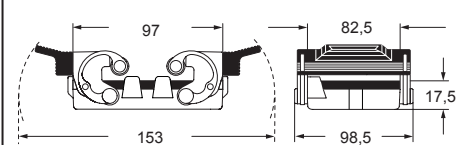
CHC C



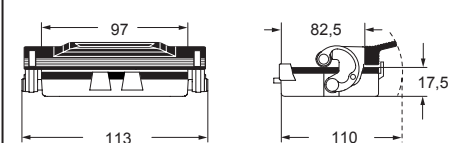
CHC L (SL)



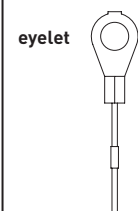
CHC G



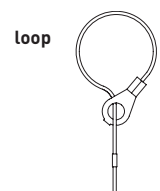
CHC LG



For fixing on housings



For fixing on hoods



CAU® Type 4/4X/12

IP65 insulating cable gland or fittings without gasket

IP66
IP69 cable gland with O-Ring gasket

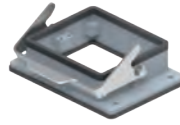
CHIX C-TYPE standard version RIGID LEVER

inserts		page:
CD	80 poles + ⊕	73
CDD	144 poles + ⊕	82
CDS	54 poles + ⊕	-
CDSH	54 poles + ⊕	90
CNE	32 poles + ⊕	114
CSE	32 poles + ⊕	-
CSH	32 poles + ⊕	114
CSH S	32 poles + ⊕	126
CCE	32 poles + ⊕	134
CSS	32 poles + ⊕	152
CTSE (16A) *	32 poles + ⊕	164
CQE	64 poles + ⊕	172
CME	12+4 (aux) poles + ⊕	142
CMSH	12+4 (aux) poles + ⊕	142
CMCE	12+4 (aux) poles + ⊕	143
CP	12 poles + ⊕	179
MIXO	4 + 4 modules	262 - 317

*) can be used only in bulkhead mounting housings

insert dimensions:
2 x (77,5 x 27) mm

bulkhead mounting housings with single lever



STAINLESS STEEL RIGID LEVER

bulkhead mounting housings with single lever, with cover



STAINLESS STEEL RIGID LEVER

description

part No.

part No.

with lever

CHIX 32 L

with lever and aluminum cover

CHIX 32 LS

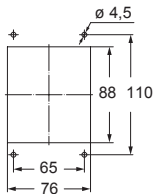
with lever and plastic cover

CHIX 32 LP

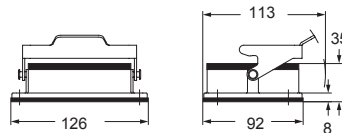
The enclosures ensure IP66/IP69 degree of protection (or IP65 for cover versions) when mated and locked with the closing levers.

Available upon request in "W-TYPE" version for aggressive environment and in 180 °C version for high temperatures.

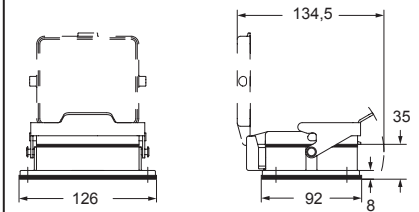
panel cut-out for bulkhead mounting housings



CHIX L



CHIX LS and CHIX LP



cURus
Type 12 / Type 4/4X
(except enclosures with plastic cover)
pending

CHPX C-TYPE standard version RIGID LEVER

inserts		page:
CD	80 poles + ⊕	73
CDD	144 poles + ⊕	82
CDS	54 poles + ⊕	-
CDSH	54 poles + ⊕	90
CNE	32 poles + ⊕	114
CSE	32 poles + ⊕	-
CSH	32 poles + ⊕	114
CSH S	32 poles + ⊕	126
CCE	32 poles + ⊕	134
CSS	32 poles + ⊕	152
CTSE (16A) *	32 poles + ⊕	164
CQE	64 poles + ⊕	172
CME	12+4 (aux) poles + ⊕	142
CMSH	12+4 (aux) poles + ⊕	142
CMCE	12+4 (aux) poles + ⊕	143
CP	12 poles + ⊕	179
MIXO	4 + 4 modules	262 - 317

*) can be used only in bulkhead mounting housings

insert dimensions:
2 x (77,5 x 27) mm

surface mounting housings with single lever



STAINLESS STEEL RIGID LEVER

surface mounting housings with single lever, with cover



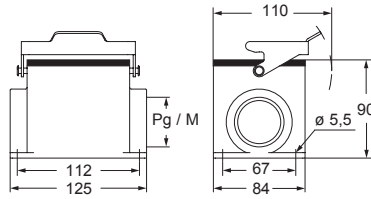
STAINLESS STEEL RIGID LEVER

description	part No.	entry Pg	part No.	entry M	part No.	entry Pg	part No.	entry M
with lever	CHPX 32 L29	29						
with lever	CHPX 32 L	36	MHPX 32 L40	40				
with lever and aluminum cover					CHPX 32 LS29	29		
with lever and aluminum cover					CHPX 32 LS	36	MHPX 32 LS40	40
with lever and plastic cover					CHPX 32 LP29	29		
with lever and plastic cover					CHPX 32 LP	36	MHPX 32 LP40	40
with lever and plastic cover							MHPX 32 LP50	50

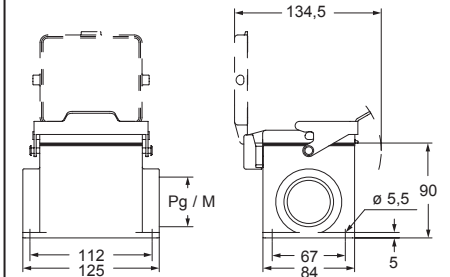
☑ The enclosures ensure IP66/IP69 degree of protection (or IP65 for cover versions) when mated and locked with the closing levers.

Available upon request in "W-TYPE" version for aggressive environment and in 180 °C version for high temperatures.

CHPX L and MHPX L



CHPX LS - MHPX LS and CHPX LP - MHPX LP



cURus
Type 12 / Type 4/4X
(except enclosures with plastic cover)
pending



insulating cable gland or fittings without gasket



cable gland with O-Ring gasket



CH - CF and MH - MF C-TYPE standard version

inserts		page:
CD	128 poles + ⊕	74
CDD	216 poles + ⊕	83
CDS	84 poles + ⊕	-
CDSH	84 poles + ⊕	91
CNE	48 poles + ⊕	115
CSE	48 poles + ⊕	-
CSH	48 poles + ⊕	115
CSH S	48 poles + ⊕	127
CCE	48 poles + ⊕	135
CME	20+4 (aux) poles + ⊕	144
CMSH	20+4 (aux) poles + ⊕	144
CSS	48 poles + ⊕	153
CTSE (16A *)	48 poles + ⊕	165
CQE	92 poles + ⊕	173
MIXO	6 + 6 modules	262 - 317

*) can be used only in bulkhead mounting housings

insert dimensions:
2 x (104 x 27) mm

bulkhead and surface mounting enclosures with single lever



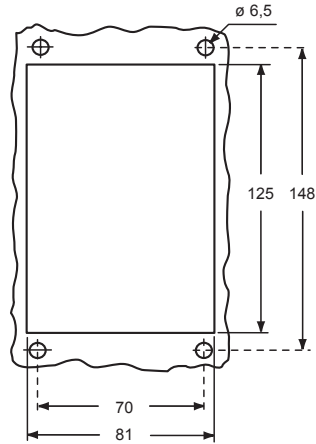
hoods with 2 pegs



description	part No.	entry Pg	part No.	entry M	part No.	entry Pg	part No.	entry M
bulkhead mounting enclosures with lever	CHI 48 L	—						
bulkhead mounting enclosures with lever and cover	CHI 48 LS	—						
surface mounting enclosures with lever and cover	CHP 48 LS29	29 x 2	MHP 48 LS40	40 x 2				
surface mounting enclosures with lever and cover	CHP 48 LS	36 x 2	MHP 48 LS50	50 x 2				
with pegs, side entry					CHO 48 L29	29	MHO 48 L32	32
with pegs, side entry					CHO 48 L	36	MHO 48 L40	40
with pegs, side entry					CHO 48 L42	42	MHO 48 L50	50
with pegs, side entry, without adapter 1)					CFO 48 L29	29	MFO 48 L32	32
with pegs, side entry, without adapter 1)					CFO 48 L	36	MFO 48 L40	40
with pegs, side entry, without adapter 1)					CFO 48 L42	42	MFO 48 L50	50
with pegs, top entry					CHV 48 L29	29	MHV 48 L32	32
with pegs, top entry					CHV 48 L	36	MHV 48 L40	40
with pegs, top entry					CHV 48 L42	42	MHV 48 L50	50
with pegs, top entry, without adaptor 1)					CFV 48 L29	29	MFV 48 L32	32
with pegs, top entry, without adaptor 1)					CFV 48 L	36	MFV 48 L40	40
with pegs, top entry, without adaptor 1)					CFV 48 L42	42	MFV 48 L50	50

1) enclosure without adapter, threaded on the body, to be used only with a complete cable gland.

panel cut-out for bulkhead mounting housings



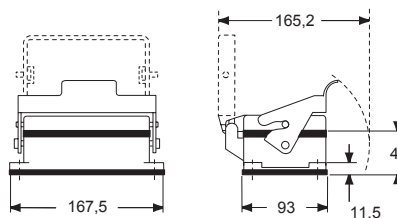
IMPORTANT NOTE: The enclosures ensure IP66/IP69 degree of protection (or IP65 for hinged cover versions) when mated and locked with the closing levers. The cover (CS, CP) only ensures mechanical protection, but does not ensure IP65 degree of protection.

CALUS Type 4/4X/12

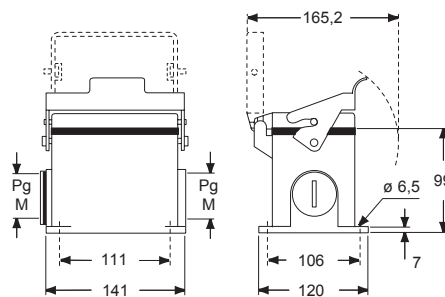
insulating cable gland or fittings without gasket

cable gland with O-Ring gasket

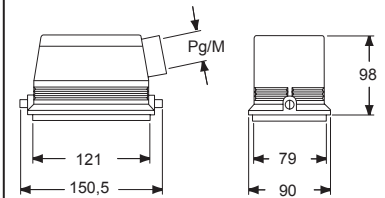
CHI L - LS



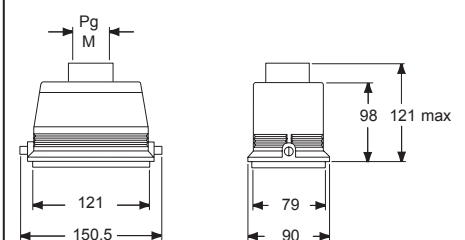
CHP LS and MHP LS



CHO/CFO L and MHO/MFO L



CHV/CFV L and MHV/MFV L



CH and MH C-TYPE standard version

inserts		page:
CD	50 poles + ⊕	71
CDD	76 poles + ⊕	80
CDA	32 poles + ⊕	102
CSAH	32 poles + ⊕	103
CDC	32 poles + ⊕	106

insert dimensions:
2 x (66 x 16) mm

bulkhead mounting housings with 2 levers or 4 pegs



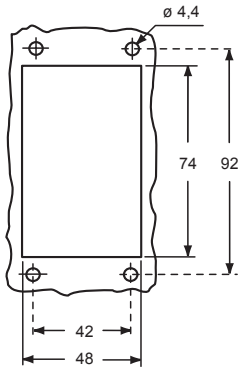
surface mounting housings with 2 levers or 4 pegs



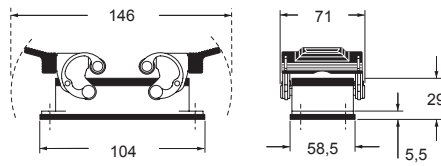
description	part No.	part No.	entry Pg	part No.	entry M
with levers	CHI 50				
with pegs and cover 1)	CHI 50 CS				
with levers		CHP 50.21	21	MHP 50.32	32
with levers		CHP 50.221	21 x 2	MHP 50.232	32 x 2
with levers		CHP 50.29	29	MHP 50.40	40
with levers		CHP 50.229	29 x 2	MHP 50.240	40 x 2
with pegs and cover 1)		CHP 50 CS	21	MHP 50 CS32	32
with pegs and cover 1)		CHP 50 CS2	21 x 2	MHP 50 CS232	32 x 2
with pegs and cover 1)		CHP 50 CS29	29	MHP 50 CS40	40
with pegs and cover 1)		CHP 50 CS229	29 x 2	MHP 50 CS240	40 x 2

1) may be combined with enclosures:
- CHO/CAO 50 X and CAV 50 X
- MHO/MAO/MFO 50 X and MAV/MFV 50 X

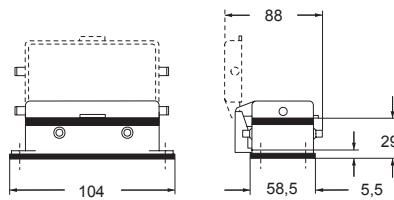
panel cut-out for bulkhead mounting housings



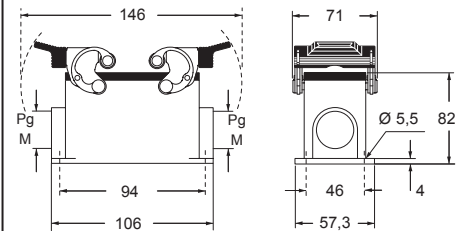
CHI



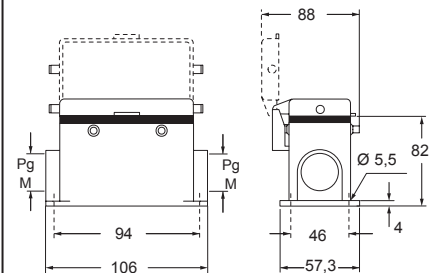
CHI CS



CHP and MHP



CHP CS and MHP CS



IMPORTANT NOTE: The enclosures ensure IP66/IP69 degree of protection (or IP65 for hinged cover versions) when mated and locked with the closing levers. The cover (CS, CP) only ensures mechanical protection, but does not ensure IP65 degree of protection.

CRAI® Type 4/4X/12

insulating cable gland or fittings without gasket

cable gland with O-Ring gasket

CH - CA - CF and MH - MA - MF C-TYPE standard version

inserts		page:
CD	50 poles + ⊕	71
CDD	76 poles + ⊕	80
CDA	32 poles + ⊕	102
CSAH	32 poles + ⊕	103
CDC	32 poles + ⊕	106

insert dimensions:
2 x (66 x 16) mm

hoods with 4 pegs



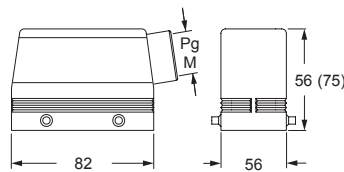
hoods with 2 levers or 4 pegs



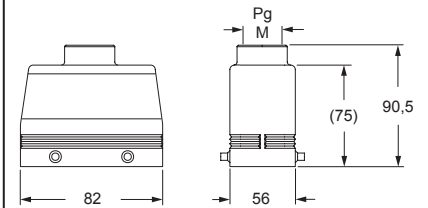
description	part No.	entry Pg	part No.	entry M	part No.	entry Pg	part No.	entry M
with pegs, side entry	CHO 50	21	MHO 50.25	25				
with pegs, side entry			MHO 50.32	32				
with pegs, side entry, high construction	CAO 50.21	21	MAO 50.25	25				
with pegs, side entry, high construction	CAO 50.29	29	MAO 50.32	32				
with pegs, top entry, high construction					CAV 50.21	21	MAV 50.25	25
with pegs, top entry, high construction					CAV 50.29	29	MAV 50.32	32
with levers and gasket, top entry, high construction					CAV 50 G29	29	MAV 50 G32	32
with pegs, side entry, high construction, without adapter 1)	CFO 50.21	21	MFO 50.25	25				
with pegs, side entry, high construction, without adapter 1)	CFO 50.29	29	MFO 50.32	32				
with pegs, top entry, high construction, without adapter 1)					CFV 50.21	21	MFV 50.25	25
with pegs, top entry, high construction, without adapter 1)					CFV 50.29	29	MFV 50.32	32
with levers and gasket, top entry, high, without adapter 1)					CFV 50 G29	29	MFV 50 G32	32

1) enclosure without adapter, threaded on the body, to be used only with a complete cable gland.

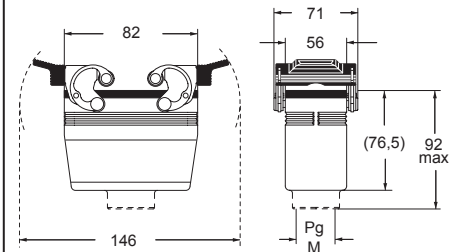
CHO (CAO/CFO) and MHO (MAO/MFO)




CAV (CFV) and MAV (MFV)




CAV G (CFV G) and MAV G (MFV G)



CAIUS® Type 4/4X/12

 insulating cable gland or fittings without gasket

 cable gland with O-Ring gasket

C-TYPE

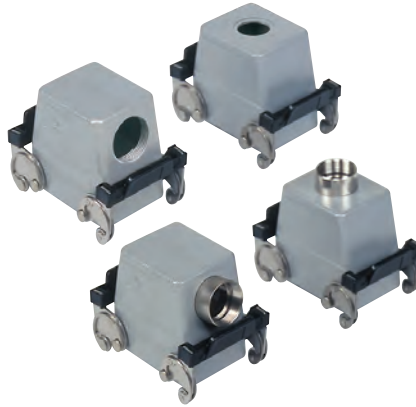
CH - CA - CF and MH - MA - MF C-TYPE standard version

inserts		page:
CD	50 poles + ⊕	71
CDD	76 poles + ⊕	80
CDA	32 poles + ⊕	102
CSAH	32 poles + ⊕	103
CDC	32 poles + ⊕	106

insert dimensions:
2 x (66 x 16) mm

Covers
cannot be used together
with metal coding pins.

hoods with 2 levers



covers

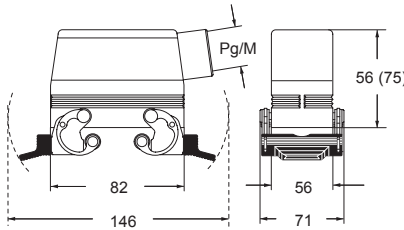


description	part No.	entry Pg	part No.	entry M	part No. (with eyelet)	part No. (with loop)
with levers, side entry ¹⁾	CHO 50 X	21	MHO 50 X25	25		
with levers, side entry ¹⁾			MHO 50 X32	32		
with levers, side entry, high construction ¹⁾	CAO 50 X	21	MAO 50 X25	25		
with levers, side entry, high construction ¹⁾	CAO 50 X29	29	MAO 50 X32	32		
with levers, top entry, high construction ¹⁾	CAV 50 X	21	MAV 50 X25	25		
with levers, top entry, high construction ¹⁾	CAV 50 X29	29	MAV 50 X32	32		
with levers, side entry, high construction, without adapter ^{1) 2)}	CFO 50 X	21	MFO 50 X25	25		
with levers, side entry, high construction, without adapter ^{1) 2)}	CFO 50 X29	29	MFO 50 X32	32		
with levers, top entry, high construction, without adapter ^{1) 2)}	CFV 50 X	21	MFV 50 X25	25		
with levers, top entry, high construction, without adapter ^{1) 2)}	CFV 50 X29	29	MFV 50 X32	32		
with 4 pegs (for enclosures with 2 levers)					CHC 50	CHC 50 S
with 2 levers and gasket (for hoods with 4 pegs)						CHC 50 G

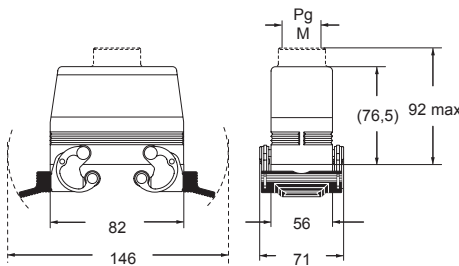
¹⁾ may be combined with enclosures:
- CHI 50 CS, CHP 50 CS and MHP 50 CS

²⁾ enclosure without adapter, threaded on the body,
to be used only with a complete cable gland.

CHO X (CAO X/CFO X) and MHO X (MAO X/MFO X)



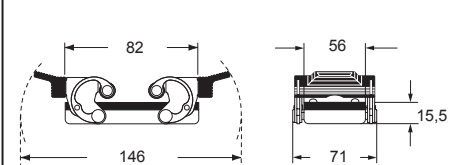
CAV X (CFV X) and MAV X (MFV X)



CHC(S)



CHC G

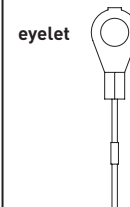


CE® **US** Type
4/4X/12

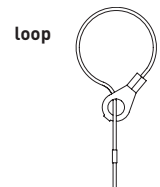
IP65 insulating cable gland or fittings
without gasket

IP66
IP69 cable gland
with O-Ring gasket

For fixing
on housings



For fixing
on hoods



CAC C-TYPE standard version

inserts		page:
CD	50 poles + ⊕	71
CDD	76 poles + ⊕	80
CDA	32 poles + ⊕	102
CSAH	32 poles + ⊕	103
CDC	32 poles + ⊕	106

insert dimensions:
2 x (66 x 16) mm

hoods without entry, to be drilled

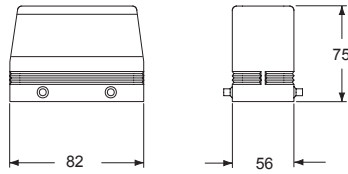


description

part No.
with 4 pegs

with pegs, high construction

CAC 50



C-TYPE

CAUS® Type
4/4X/12



V-TYPE

Extra tough

The performance requirements in **connection protection** are increasingly varied and specialized.

To respond to this wide range of needs, **ILME has developed several original solutions, including the innovative V-TYPE lever.**

This proprietary lever, due to the **vertical closing movement, offers an IP66/IP67/IP69 degree of protection** (according to EN 60529) when fitted with a complete and coupled connector **and used with ILME standard hoods in die cast aluminium moulded (without adaptor).**

The high degree of protection is therefore not dependant on the use of special gaskets or locking devices.

The fixing flanges are the same as those fitted on traditional models.

This means it is possible to use the housings **as alternatives to the traditional version without affecting the interchangeability**, or changing dimensions, spaces, flanges or fixing positions.

This lever differs from other commercial ones because of its closing movement principle, consisting of 2 hinged elements that are then pivoted on the housing.

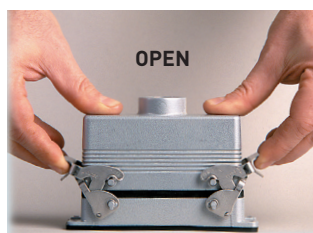
This composite movement enables to move the lever above the pin of the housing that has to be fixed in place with an initial rotatory movement and then press it downwards to engage the locking mechanism.

The tight seal after closure and the simplicity of the movement are key characteristics that **only ILME has managed to combine into a single lever.**

SUM-UP

- ☑ **The friction on the pin is almost zero because the lever exerts its pressure vertically, thus significantly reducing wear in case of frequent use**
- ☑ **The complete lever is manufactured in stainless steel and is fitted with a catch that prevents it from being accidentally detached**
- ☑ **The absence of parts in plastic offers a higher resistance to impacts and in case of contact with oils and aggressive chemical substances or high ambient temperatures**
- ☑ **The lever can be used for applications with vibrations because it has no springs and is therefore more rigid**
- ☑ **The lever occupies a very small space during the closing phase**
- ☑ **It is recommended in cases when the cable weight forces the levers to open, such as vertically installed connectors and the cable is mounted in the bottom**

The interchangeability with equivalent traditional levers with springs and rollers **simplifies the management of stocks, reduces costs and increases flexibility of use.**



Available in bulkhead or surface-mounted versions for sizes 44.27 with a single lever, 57.27, 77.27 and 104.27 with 2 levers. High construction models are available on request.

The item code identifies the series with the **suffix C7 or M7:**

- **C7I** bulkhead mounting housing
- **C7P** surface mounting housing, Pg thread, standard height
- **M7P** surface mounting housing, metric thread, standard height
- **C7AP** surface mounting housing, Pg thread, high
- **M7AP** surface mounting housing, metric thread, high.



V-TYPE,
discover the
vertical closing

C7 - C7A and M7 - M7A IP67 enclosures V-TYPE lever version

inserts		page:
CDD	24 poles + ⊕	76
CDS	9 poles + ⊕	-
CDSH	9 poles + ⊕	86
CDSH NC	6 poles + ⊕	95
CNE	6 poles + ⊕	110
CSE	6 poles + ⊕	-
CSH	6 poles + ⊕	110
CSH S	6 poles + ⊕	122
CCE	6 poles + ⊕	130
CSS	6 poles + ⊕	148
CT, CTSE (16A) *	6 poles + ⊕	160
CQE	10 poles + ⊕	168
MIXO	2 modules	262 - 317

*) can be used only in bulkhead mounting housings

bulkhead mounting housings with stainless steel single lever

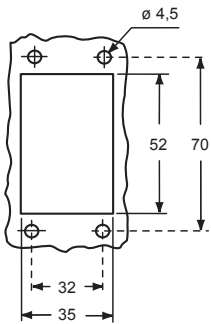


surface mounting housings with stainless steel single lever



description	part No.	part No.	entry Pg	part No.	entry M
with lever and gasket, size "44.27"	C7I 06 L				
with lever, size "44.27"		C7P 06 L	16	M7P 06 L20	20
with lever, size "44.27"		C7P 06 L2	16 x 2	M7P 06 L220	20 x 2
with lever, high construction, size "44.27"		C7AP 06 L	21	M7AP 06 L32	32
with lever, high construction, size "44.27"		C7AP 06 L2	21 x 2	M7AP 06 L232	32 x 2
with lever, high construction, size "44.27"		C7AP 06 L29	29	M7AP 06 L40	40
with lever, high construction, size "44.27"		C7AP 06 L229	29 x 2	M7AP 06 L240	40 x 2

panel cut-out for bulkhead mounting housings



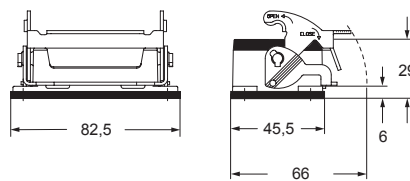
The lever, due to the vertical closing movement, offers an IP66/IP67/IP69 degree of protection (according to EN 60529) when fitted with a complete and coupled connector and used with ILME standard hoods in die cast aluminum with pegs (without adapter).

Hoods (page 389)



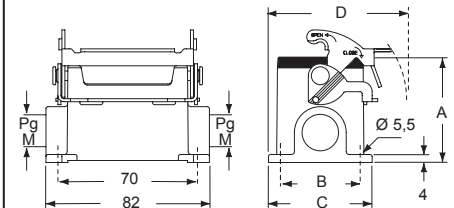
Hoods (pages 466-467)

C7I L




For bulkhead mounting housings, IP66/IP67/IP69 degree of protection is guaranteed for mounting on a sufficiently rigid panel; use suitable length M4 screws (negligible surface buckling when subjected to tightening couple on the fixing screws of 0,8 - 1,2 Nm or deformation caused by the weight of the complete connector). In case of insufficient rigidity use of C7.. FL counterflanges (page 443) is recommended, in which case use suitable length M4 screws and M4 (on the enclosure) and M4 (on the counterflange) flat/ spring washers with M4 locknut. In addition, the panel surface in contact with the counterflange gasket of the bulkhead mounting housings must be free from defects (deep scratches, grooves, burrs) that could negatively affect the performance of the gasket.


C7P L - C7AP L and M7P L - M7AP L



type	A	B	C	D
C7P/M7P 06 L	53	40	52	70
C7AP/M7AP 06 L	74	45	57	72,5

CAIUS Type 4/4X/12

 insulating cable gland or fittings without gasket

 cable gland with O-Ring gasket

C7 and M7 - M7A IP67 enclosures V-TYPE lever version

inserts		page:
CDD	24 poles + ⊕	76
CDS	9 poles + ⊕	-
CDSH	9 poles + ⊕	86
CDSH NC	6 poles + ⊕	95
CNE	6 poles + ⊕	110
CSE	6 poles + ⊕	-
CSH	6 poles + ⊕	110
CSH S	6 poles + ⊕	122
CCE	6 poles + ⊕	130
CSS	6 poles + ⊕	148
CT, CTSE (16A *)	6 poles + ⊕	160
CQE	10 poles + ⊕	168
MIXO	2 modules	262 - 317

*) can be used only in bulkhead mounting housings

bulkhead mounting housings with stainless steel single lever and metal cover

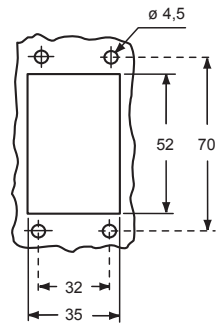


surface mounting housings with stainless steel single lever and metal cover



description	part No.	part No.	entry M
with lever, cover and gasket, size "44.27"	C7I 06 LS		
with lever and cover, size "44.27"		M7P 06 LS20	20
with lever and cover, high construction, size "44.27"		M7P 06 LS220	20 x 2
with lever and cover, high construction, size "44.27"		M7AP 06 LS32	32
with lever and cover, high construction, size "44.27"		M7AP 06LS232	32 x 2
with lever and cover, high construction, size "44.27"		M7AP 06 LS40	40
with lever and cover, high construction, size "44.27"		M7AP 06LS240	40 x 2

panel cut-out for bulkhead mounting housings



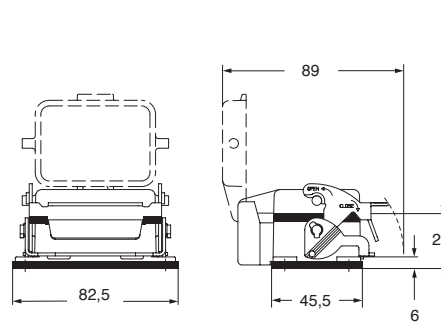
The lever, due to the vertical closing movement, offers an IP66/IP67/IP69 degree of protection (according to EN 60529) when fitted with a complete and coupled connector and used with ILME standard hoods in die cast aluminum with pegs (without adapter).

Hoods (page 389)

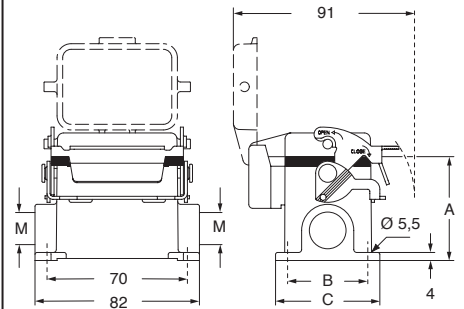


Hoods (pages 466-467)

C7I LS



M7P LS - M7AP LS



type	A	B	C
M7P 06 LS	53	40	52
M7AP 06 LS	74	45	57

For bulkhead mounting housings, IP66/IP67/IP69 degree of protection is guaranteed for mounting on a sufficiently rigid panel; use suitable length M4 screws (negligible surface buckling when subjected to tightening couple on the fixing screws of 0,8 - 1,2 Nm or deformation caused by the weight of the complete connector). In case of insufficient rigidity use of C7.. FL counterflanges (page 443) is recommended, in which case use suitable length M4 screws and M4 (on the enclosure) and M4 (on the counterflange) flat/ spring washers with M4 locknut. In addition, the panel surface in contact with the counterflange gasket of the bulkhead mounting housings must be free from defects (deep scratches, grooves, burrs) that could negatively affect the performance of the gasket.

CAIUS Type 4/4X/12

insulating cable gland or fittings without gasket

cable gland with O-Ring gasket

C7 - C7A and M7 - M7A IP67 enclosures V-TYPE lever version

inserts		page:
CDD	42 poles + ⊕	78
CDS	18 poles + ⊕	-
CDSH	18 poles + ⊕	87
CNE	10 poles + ⊕	111
CSE	10 poles + ⊕	-
CSH	10 poles + ⊕	111
CSH S	10 poles + ⊕	123
CCE	10 poles + ⊕	131
CMSH	3+2 (aux) poles + ⊕	136
CMCE	3+2 (aux) poles + ⊕	137
CSS	10 poles + ⊕	149
CT, CTSE (16A) *)	10 poles + ⊕	161
CQE	18 poles + ⊕	169
CX	8/24 poles + ⊕	194
MIXO	3 modules	262 - 317

*) can be used only in bulkhead mounting housings

bulkhead mounting housings with 2 levers in stainless steel

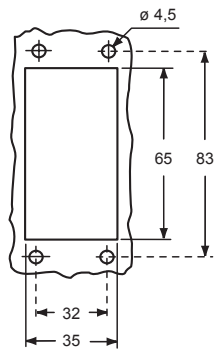


surface mounting housings with 2 levers in stainless steel



description	part No.	part No.	entry Pg	part No.	entry M
with levers and gasket, size "57.27"	C71 10				
with levers, size "57.27"		C7P 10	16	M7P 10.20	20
with levers, size "57.27"		C7P 10.2	16 x 2	M7P 10.220	20 x 2
with levers, high construction, size "57.27"		C7AP 10.21	21	M7AP 10.32	32
with levers, high construction, size "57.27"		C7AP 10.221	21 x 2	M7AP 10.232	32 x 2
with levers, high construction, size "57.27"		C7AP 10.29	29	M7AP 10.40	40
with levers, high construction, size "57.27"		C7AP 10.229	29 x 2	M7AP 10.240	40 x 2

panel cut-out for bulkhead mounting housings




The lever, due to the vertical closing movement, offers an IP66/IP67/IP69 degree of protection (according to EN 60529) when fitted with a complete and coupled connector and used with ILME standard hoods in die cast aluminum with pegs (without adapter).


Hoods
(page 395)



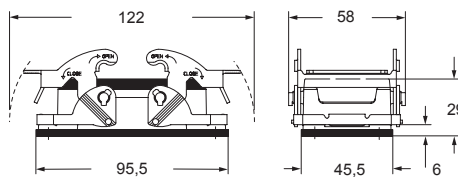
Hoods
(pages 468-469)

CAUS® Type 4/4X/12

 IP65 insulating cable gland or fittings without gasket

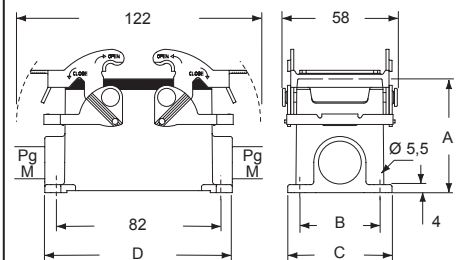
 IP66 IP67 IP68 cable gland with O-Ring gasket

C71



For bulkhead mounting housings, IP66/IP67/IP69 degree of protection is guaranteed for mounting on a sufficiently rigid panel; use suitable length M4 screws (negligible surface buckling when subjected to tightening couple on the fixing screws of 0,8 - 1,2 Nm or deformation caused by the weight of the complete connector). In case of insufficient rigidity use of C7.. FL counterflanges (page 443) is recommended, in which case use suitable length M4 screws and M4 (on the enclosure) and M4 (on the counterflange) flat/spring washers with M4 locknut. In addition, the panel surface in contact with the counterflange gasket of the bulkhead mounting housings must be free from defects (deep scratches, grooves, burrs) that could negatively affect the performance of the gasket.

C7P - C7AP and M7P - M7AP



type	A	B	C	D
C7P/M7P 10	57	40	52	93,5
C7AP/M7AP 10	74	45	57	94

C7 - C7A and M7 - M7A IP67 enclosures V-TYPE lever version

inserts		page:
CD	40 poles + ⊕	70
CDD	72 poles + ⊕	79
CDS	27 poles + ⊕	-
CDSH	27 poles + ⊕	88
CNE	16 poles + ⊕	112
CSE	16 poles + ⊕	-
CSH	16 poles + ⊕	112
CSH S	16 poles + ⊕	124
CCE	16 poles + ⊕	132
CMSH, CMCE	6+2 (aux) poles + ⊕	138 - 139
CSS	16 poles + ⊕	150
CT, CTS (10A) *)	40 poles + ⊕	156
CT, CTSE (16A) *)	16 poles + ⊕	162
CQE	32 poles + ⊕	170
CQEE	40 poles + ⊕	176
CP	6 poles + ⊕	178
CX	6/12, 6/36 and 12/2 poles + ⊕	197 - 199
CX	4/0 and 4/2 poles + ⊕	200 - 201
MIXO	4 modules	262 - 317

*) can be used only in bulkhead mounting housings

bulkhead mounting housings with 2 levers in stainless steel

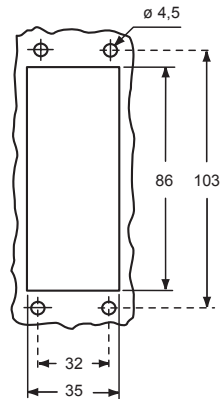


surface mounting housings with 2 levers in stainless steel



description	part No.	part No.	entry Pg	part No.	entry M
with levers and gasket, size "77.27"	C71 16				
with levers, size "77.27"		C7P 16	21	M7P 16.25	25
with levers, size "77.27"		C7P 16.2	21 x 2	M7P 16.225	25 x 2
with levers, high construction, size "77.27"		C7AP 16.21	21	M7AP 16.32	32
with levers, high construction, size "77.27"		C7AP 16.221	21 x 2	M7AP 16.232	32 x 2
with levers, high construction, size "77.27"		C7AP 16.29	29	M7AP 16.40	40
with levers, high construction, size "77.27"		C7AP 16.229	29 x 2	M7AP 16.240	40 x 2

panel cut-out for bulkhead mounting housings



The lever, due to the vertical closing movement, offers an IP66/IP67/IP69 degree of protection (according to EN 60529) when fitted with a complete and coupled connector and used with ILME standard hoods in die cast aluminum with pegs (without adapter).

Hoods (page 404)



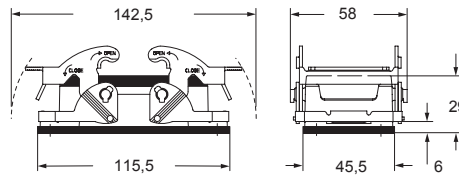
Hoods (pages 470-471)

CAUS® Type 4/4X/12

insulating cable gland or fittings without gasket

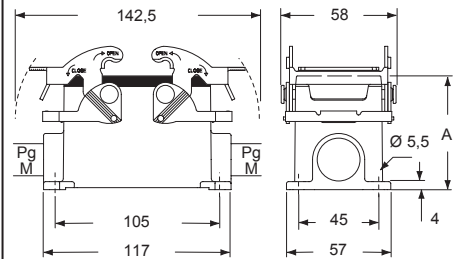
cable gland with O-Ring gasket

C71



For bulkhead mounting housings, IP66/IP67/IP69 degree of protection is guaranteed for mounting on a sufficiently rigid panel; use suitable length M4 screws (negligible surface buckling when subjected to tightening couple on the fixing screws of 0,8 - 1,2 Nm or deformation caused by the weight of the complete connector). In case of insufficient rigidity use of C7.. FL counterflanges (page 443) is recommended, in which case use suitable length M4 screws and M4 (on the enclosure) and M4 (on the counterflange) flat/ spring washers with M4 locknut. In addition, the panel surface in contact with the counterflange gasket of the bulkhead mounting housings must be free from defects (deep scratches, grooves, burrs) that could negatively affect the performance of the gasket.

C7P - C7AP and M7P - M7AP



type	A
C7P/M7P 16	63
C7AP/M7AP 16	81

C7 and M7A IP67 enclosures V-TYPE lever version

inserts		page:
CD	40 poles + ⊕	70
CDD	72 poles + ⊕	79
CDS	27 poles + ⊕	-
CDSH	27 poles + ⊕	88
CNE	16 poles + ⊕	112
CSE	16 poles + ⊕	-
CSH	16 poles + ⊕	112
CSH S	16 poles + ⊕	124
CCE	16 poles + ⊕	132
CMSH, CMCE	6+2 (aux) poles + ⊕	138 - 139
CSS	16 poles + ⊕	150
CT, CTS (10A) *)	40 poles + ⊕	156
CT, CTSE (16A) *)	16 poles + ⊕	162
CQE	32 poles + ⊕	170
CQEE	40 poles + ⊕	176
CP	6 poles + ⊕	178
CX	6/12, 6/36 and 12/2 poles + ⊕	197 - 199
CX	4/0 and 4/2 poles + ⊕	200 - 201
MIXO	4 modules	262 - 317

*) can be used only in bulkhead mounting housings

bulkhead mounting housings with 2 levers in stainless steel and metal cover

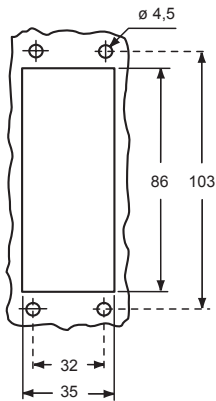


surface mounting housings with 2 levers in stainless steel and metal cover

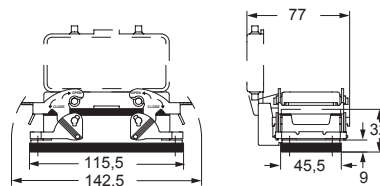


description	part No.	part No.	entry M
with levers, cover and gasket, size "77.27"	C7I 16 S		
with levers and cover, high construction, size "77.27"		M7AP 16 S32	32
with levers and cover, high construction, size "77.27"		M7AP 16 S232	32 x 2

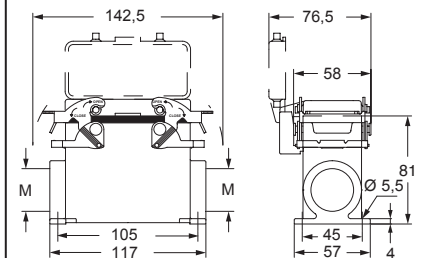
panel cut-out for bulkhead mounting housings



C7I S



M7AP S



The lever, due to the vertical closing movement, offers an IP66/IP67/IP69 degree of protection (according to EN 60529) when fitted with a complete and coupled connector and used with ILME standard hoods in die cast aluminum with pegs (without adapter).

Hoods (page 404)



Hoods (pages 470-471)

CAUS® Type 4/4X/12



insulating cable gland or fittings without gasket



cable gland with O-Ring gasket

For bulkhead mounting housings, IP66/IP67/IP69 degree of protection is guaranteed for mounting on a sufficiently rigid panel; use suitable length M4 screws (negligible surface buckling when subjected to tightening couple on the fixing screws of 0,8 - 1,2 Nm or deformation caused by the weight of the complete connector). In case of insufficient rigidity use of C7.. FL counterflanges (page 443) is recommended, in which case use suitable length M4 screws and M4 (on the enclosure) and M4 (on the counterflange) flat/ spring washers with M4 locknut. In addition, the panel surface in contact with the counterflange gasket of the bulkhead mounting housings must be free from defects (deep scratches, grooves, burrs) that could negatively affect the performance of the gasket.

C7 - C7A and M7 - M7A IP67 enclosures V-TYPE lever version

inserts		page:
CD	64 poles + ⊕	72
CDD	108 poles + ⊕	81
CDS	42 poles + ⊕	-
CDSH	42 poles + ⊕	89
CNE	24 poles + ⊕	113
CSE	24 poles + ⊕	-
CSH	24 poles + ⊕	113
CSH S	24 poles + ⊕	125
CCE	24 poles + ⊕	133
CMSH	10+2 (aux) poles + ⊕	140
CMCE	10+2 (aux) poles + ⊕	141
CSS	24 poles + ⊕	151
CT, CTS (10A *)	64 poles + ⊕	157
CT, CTSE (16A *)	24 poles + ⊕	163
CQE	46 poles + ⊕	171
CQEE	64 poles + ⊕	177
CX	4/8 and 6/6 poles + ⊕	204, 206
MIXO	6 modules	262 - 317

*) can be used only in bulkhead mounting housings

bulkhead mounting housings with 2 levers in stainless steel

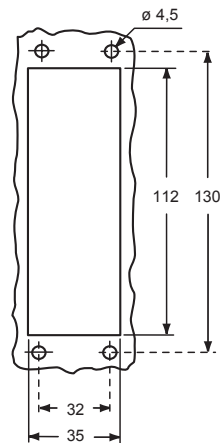


surface mounting housings with 2 levers in stainless steel



description	part No.	entry Pg	part No.	entry M	
with levers and gasket, size "104.27"	C7I 24				
with levers, size "104.27"		C7P 24	21	M7P 24.25	25
with levers, size "104.27"		C7P 24.2	21 x 2	M7P 24.225	25 x 2
with levers, high construction, size "104.27"		C7AP 24.21	21	M7AP 24.32	32
with levers, high construction, size "104.27"		C7AP 24.221	21 x 2	M7AP 24.232	32 x 2
with levers, high construction, size "104.27"		C7AP 24.29	29	M7AP 24.40	40
with levers, high construction, size "104.27"		C7AP 24.229	29 x 2	M7AP 24.240	40 x 2

panel cut-out for bulkhead mounting housings



The lever, due to the vertical closing movement, offers an IP66/IP67/IP69 degree of protection (according to EN 60529) when fitted with a complete and coupled connector and used with ILME standard hoods in die cast aluminum with pegs (without adapter).

Hoods (page 414)



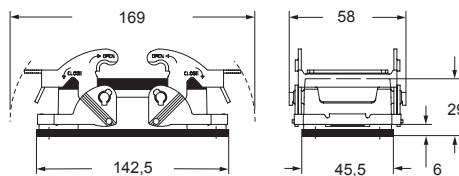
Hoods (pages 472-473)

CAUS® Type 4/4X/12

insulating cable gland or fittings without gasket

cable gland with O-Ring gasket

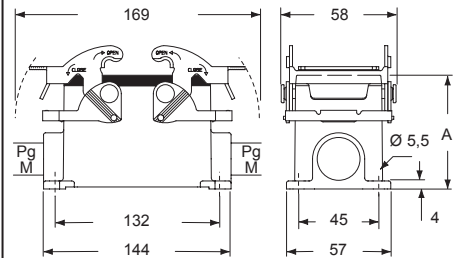
C7I



For bulkhead mounting housings, IP66/IP67/IP69 degree of protection is guaranteed for mounting on a sufficiently rigid panel; use suitable length M4 screws (negligible surface buckling when subjected to tightening couple on the fixing screws of 0,8 - 1,2 Nm or deformation caused by the weight of the complete connector). In case of insufficient rigidity use of C7.. FL counterflanges (page 443) is recommended, in which case use suitable length M4 screws and M4 (on the enclosure) and M4 (on the counterflange) flat/spring washers with M4 locknut.

In addition, the panel surface in contact with the counterflange gasket of the bulkhead mounting housings must be free from defects (deep scratches, grooves, burrs) that could negatively affect the performance of the gasket.

C7P - C7AP and M7P - M7AP



type	A
C7P/M7P 24	63
C7AP/M7AP 24	81

C7 and M7A IP67 enclosures V-TYPE lever version

inserts		page:
CD	64 poles + ⊕	72
CDD	108 poles + ⊕	81
CDS	42 poles + ⊕	-
CDSH	42 poles + ⊕	89
CNE	24 poles + ⊕	113
CSE	24 poles + ⊕	-
CSH	24 poles + ⊕	113
CSH S	24 poles + ⊕	125
CCE	24 poles + ⊕	133
CMSH	10+2 (aux) poles + ⊕	140
CMCE	10+2 (aux) poles + ⊕	141
CSS	24 poles + ⊕	151
CT, CTS (10A) *)	64 poles + ⊕	157
CT, CTSE (16A) *)	24 poles + ⊕	163
CQE	46 poles + ⊕	171
CQEE	64 poles + ⊕	177
CX	4/8 and 6/6 poles + ⊕	204, 206
MIXO	6 modules	262 - 317

*) can be used only in bulkhead mounting housings

bulkhead mounting housings with 2 levers in stainless steel and metal cover

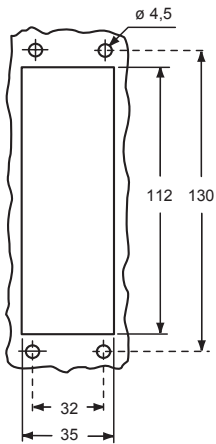


surface mounting housings with 2 levers in stainless steel and metal cover



description	part No.	part No.	entry
with levers, cover and gasket, size "104.27"	C7I 24 S		
with levers and cover, high construction, size "104.27"		M7AP 24 S32	32
with levers and cover, high construction, size "104.27"		M7AP 24 S232	32 x 2

panel cut-out for bulkhead mounting housings



The lever, due to the vertical closing movement, offers an IP66/IP67/IP69 degree of protection (according to EN 60529) when fitted with a complete and coupled connector and used with ILME standard hoods in die cast aluminum with pegs (without adapter).

Hoods (page 414)



Hoods (page 472 - 473)

CAIUS® Type 4/4X/12

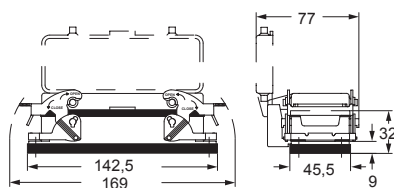


insulating cable gland or fittings without gasket



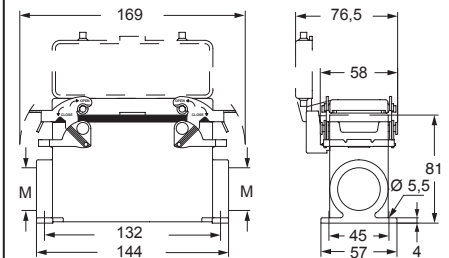
cable gland with O-Ring gasket

C7I S



For bulkhead mounting housings, IP66/IP67/IP69 degree of protection is guaranteed for mounting on a sufficiently rigid panel; use suitable length M4 screws (negligible surface buckling when subjected to tightening couple on the fixing screws of 0,8 - 1,2 Nm or deformation caused by the weight of the complete connector). In case of insufficient rigidity use of C7.. FL counterflanges (page 443) is recommended, in which case use suitable length M4 screws and M4 (on the enclosure) and M4 (on the counterflange) flat/spring washers with M4 locknut. In addition, the panel surface in contact with the counterflange gasket of the bulkhead mounting housings must be free from defects (deep scratches, grooves, burrs) that could negatively affect the performance of the gasket.

M7AP S



counterflanges
for bulkhead mounting housings



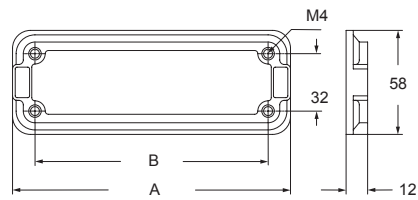
description

part No.

size "44.27"
size "57.27"
size "77.27"
size "104.27"

C7 06 FL
C7 10 FL
C7 16 FL
C7 24 FL

C7..FL



type	A	B
C7 06 FL	95	70
C7 10 FL	108	83
C7 16 FL	128	103
C7 24 FL	155	130

CV V-TYPE lever version

inserts		page:
CDD	24 poles + ⊕	76
CDS	9 poles + ⊕	-
CDSH	9 poles + ⊕	86
CDSH NC	6 poles + ⊕	95
CNE	6 poles + ⊕	110
CSE	6 poles + ⊕	-
CSH	6 poles + ⊕	110
CSH S	6 poles + ⊕	122
CCE	6 poles + ⊕	130
CSS	6 poles + ⊕	148
CT, CTSE (16A) *	6 poles + ⊕	160
CQE	10 poles + ⊕	168
MIXO	2 modules	262 - 317

*) can be used only in bulkhead mounting housings

bulkhead mounting housings with stainless steel single lever

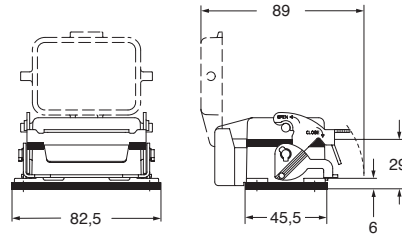
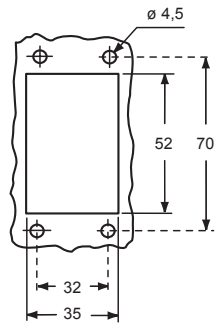


description	part No.
with lever, gasket and cover in aluminium, size "44.27"	CVI 06 LS
with lever, gasket and cover in plastic, size "44.27"	CVI 06 LP

The enclosures ensure IP66 (or IP65 cover versions) degree of protection when mated and locked with the closing levers.

CVI LS/LP

panel cut-out for bulkhead mounting housings



Hoods
(from page 389)



CAUS® Type 4/4X/12
(except enclosures with plastic cover)



CV - CVA and MV - MVA V-TYPE lever SIMPLEX self-closing covers

inserts		page:
CDD	24 poles + ⊕	76
CDS	9 poles + ⊕	-
CDSH	9 poles + ⊕	86
CDSH NC	6 poles + ⊕	95
CNE	6 poles + ⊕	110
CSE	6 poles + ⊕	-
CSH	6 poles + ⊕	110
CSH S	6 poles + ⊕	122
CCE	6 poles + ⊕	130
CSS	6 poles + ⊕	148
CT, CTSE (16A) *)	6 poles + ⊕	160
CQE	10 poles + ⊕	168
MIXO	2 modules	262 - 317

*) can be used only in bulkhead mounting housings

bulkhead mounting housings with stainless steel single lever



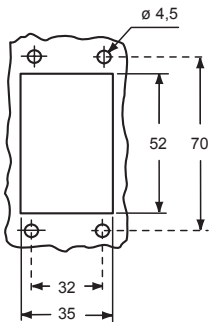
surface mounting housings with stainless steel single lever



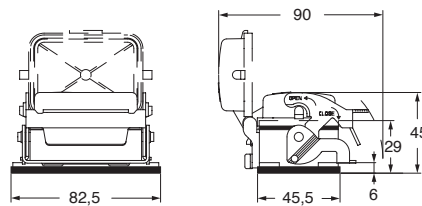
description	part No.	entry Pg	part No.	entry M
with lever, gasket and cover in plastic	CVI 06 LSP			
with lever and cover			CVP 06 LSP16	16
with lever and cover, high construction			CVAP 06LSP21	21
with lever and cover, high construction			CVAP 06LSP29	29
with lever and cover, high construction			MVP 06 LSP20	20
			MVAP 06LSP25	25
			MVAP 06LSP32	32
			MVAP 06LSP40	40

The enclosures ensure IP65 degree of protection when mated and locked with the closing lever, or IP44 degree of protection when not mated and locked with lever.

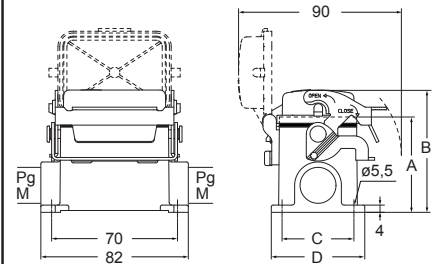
panel cut-out for bulkhead mounting housings



CVI LSP



CVP - CVAP LSP and MVP - MVAP LSP



type	A	B	C	D
CVP / MVP 6 LSP	53	68	40	52
CVAP / MVAP 6 LSP	74	89	45	57

Hoods
(from page 389)



CRUS Type 4/4X/12



CRUS Type 4/4X/12 pending



CV - CVA and MV - MVA V-TYPE lever version

inserts		page:
CDD	24 poles + ⊕	76
CDS	9 poles + ⊕	-
CDSH	9 poles + ⊕	86
CDSH NC	6 poles + ⊕	95
CNE	6 poles + ⊕	110
CSE	6 poles + ⊕	-
CSH	6 poles + ⊕	110
CSH S	6 poles + ⊕	122
CCE	6 poles + ⊕	130
CSS	6 poles + ⊕	148
CQE	10 poles + ⊕	168
MIXO	2 modules	262 - 317

surface mounting housings with stainless steel single lever and plastic cover



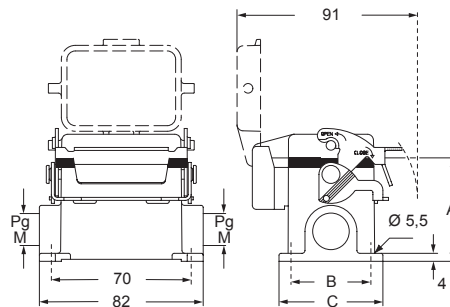
surface mounting housings with stainless steel single lever and aluminium cover



description	part No.	entry Pg	part No	entry M	part No.	entry Pg	part No.	entry M
with lever and cover, size "44.27"	CVP 06 LP	16	MVP 06 LP20	20	CVP 06 LS	16	MVP 06 LS20	20
with lever and cover, size "44.27"	CVP 06 LP2	16 x 2	MVP 06 LP220	20 x 2	CVP 06 LS2	16 x 2	MVP 06 LS220	20 x 2
with lever and cover, high construction, size "44.27"	CVAP 06 LP	21	MVAP 06 LP32	32	CVAP 06 LS	21	MVAP 06 LS32	32
with lever and cover, high construction, size "44.27"	CVAP 06 LP2	21 x 2	MVAP 06LP232	32 x 2	CVAP 06 LS2	21 x 2	MVAP 06LS232	32 x 2
with lever and cover, high construction, size "44.27"	CVAP 06 LP29	29	MVAP 06 LP40	40	CVAP 06 LS29	29	MVAP 06 LS40	40
with lever and cover, high construction, size "44.27"	CVAP 06LP229	29 x 2	MVAP 06LP240	40 x 2	CVAP 06LS229	29 x 2	MVAP 06LS240	40 x 2

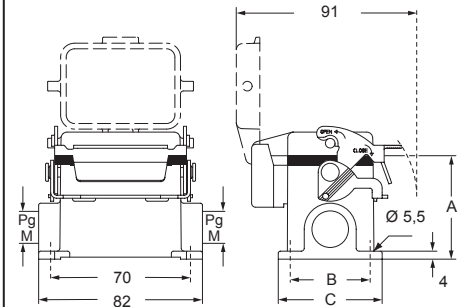
☑ The enclosures ensure IP66 (or IP65 cover versions) degree of protection when mated and locked with the closing levers.

CVP LP - CVAP LP and MVP LP - MVAP LP



type	A	B	C
CVP/MVP 06 LP	53	40	52
CVAP/MVAP 06 LP	74	45	57

CVP LS - CVAP LS and MVP LS - MVAP LS



type	A	B	C
CVP/MVP 06 LS	53	40	52
CVAP/MVAP 06 LS	74	45	57

Hoods
(from page 389)



CAVUS® Type 4/4X/12
(except enclosures with plastic cover)



V-TYPE IP65/IP66

CV - CVA - CVF and MV - MVA - MVF V-TYPE lever version

inserts		page:
CDD	24 poles + ⊕	76
CDS	9 poles + ⊕	-
CDSH	9 poles + ⊕	86
CDSH NC	6 poles + ⊕	95
CNE	6 poles + ⊕	110
CSE	6 poles + ⊕	-
CSH	6 poles + ⊕	110
CSH S	6 poles + ⊕	122
CCE	6 poles + ⊕	130
CSS	6 poles + ⊕	148
CQE	10 poles + ⊕	168
MIXO	2 modules	262 - 317

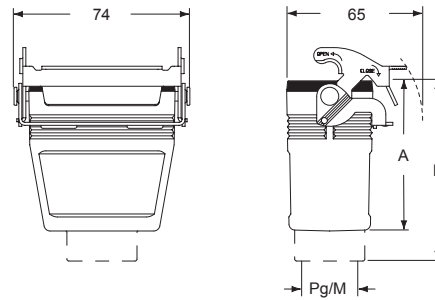
hoods, top entry with gasket and stainless steel single lever



description	part No.	entry Pg	part No	entry M
with lever, size "44.27"	CVV 06 LG	16	MVV 06 LG25	25
with lever, high construction, size "44.27"	CVAV 06 LG21	21	MVAV 06 LG25	25
with lever, high construction, size "44.27"	CVAV 06 LG29	29	MVAV 06 LG32	32
with lever, high construction, without adapter, size "44.27" 1)	CVFV 06 LG21	21	MVFV 06 LG25	25
with lever, high construction, without adapter, size "44.27" 1)	CVFV 06 LG29	29	MVFV 06 LG32	32

1) enclosure without adapter, threaded on the body, to be used only with a complete cable gland.

CVV LG - CVAV LG - CVFV LG and MVV LG - MVAV LG - MVFV LG



type	A	B
CVV/MVV 06 LG	45,5	58,5
CVAV/MVAV 06 LG	77	93
CVFV/MVFV 06 LG	77	-

Hoods
(from page 389)



CAVUS® Type
4/4X/12

insulating cable gland or fittings
without gasket

cable gland
with O-Ring gasket

CV V-TYPE lever version

inserts		page:
CDD	42 poles + ⊕	78
CDS	18 poles + ⊕	-
CDSH	18 poles + ⊕	87
CNE	10 poles + ⊕	111
CSE	10 poles + ⊕	-
CSH	10 poles + ⊕	111
CSH S	10 poles + ⊕	123
CCE	10 poles + ⊕	131
CMSH	3+2 (aux) poles + ⊕	136
CMCE	3+2 (aux) poles + ⊕	137
CSS	10 poles + ⊕	149
CT, CTSE (16A) *)	10 poles + ⊕	161
CQE	18 poles + ⊕	169
CX	8/24 poles + ⊕	194
MIXO	3 modules	262 - 317

*) can be used only in bulkhead mounting housings

bulkhead mounting housings with single lever in stainless steel



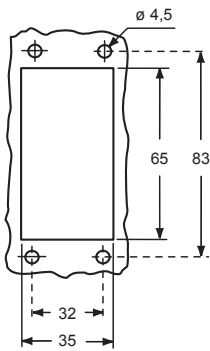
bulkhead mounting housings with single lever in stainless steel



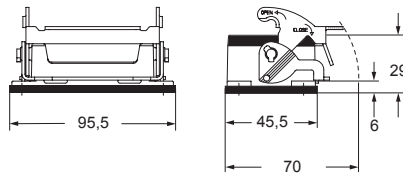
description	part No.	part No.
with lever and gasket, size "57.27"	CVI 10 L	
with lever, gasket and cover in aluminium, size "57.27"		CVI 10 LS
with lever, gasket and cover in plastic, size "57.27"		CVI 10 LP

☑ The enclosures ensure IP66/IP69 (or IP65 cover versions) degree of protection when mated and locked with the closing levers.

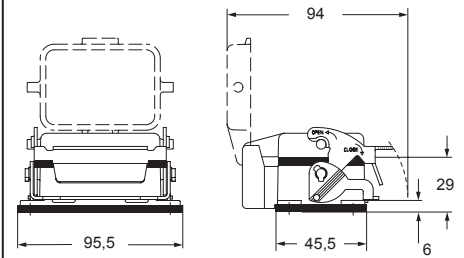
panel cut-out for bulkhead mounting housings



CVI L



CVI LS/LP



Hoods
(from page 395)



CAVUS® Type 4/4X/12



CAVUS® Type 4/4X/12
(except enclosures with plastic cover)



V-TYPE IP65/IP66

CV - CVA and MV - MVA V-TYPE lever SIMPLEX self-closing covers

inserts		page:
CDD	42 poles + ⊕	78
CDS	18 poles + ⊕	-
CDSH	18 poles + ⊕	87
CNE	10 poles + ⊕	111
CSE	10 poles + ⊕	-
CSH	10 poles + ⊕	111
CSH S	10 poles + ⊕	123
CCE	10 poles + ⊕	131
CMSH	3+2 (aux) poles + ⊕	136
CMCE	3+2 (aux) poles + ⊕	137
CSS	10 poles + ⊕	149
CT, CTSE (16A) *)	10 poles + ⊕	161
CQE	18 poles + ⊕	169
CX	8/24 poles + ⊕	194
MIXO	3 modules	262 - 317

*) can be used only in bulkhead mounting housings

bulkhead mounting housings with stainless steel single lever



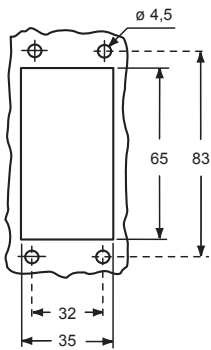
surface mounting housings with stainless steel single lever



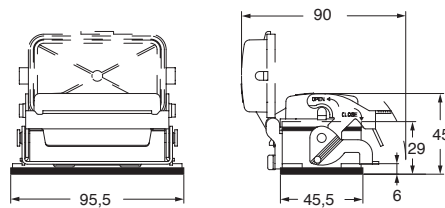
description	part No.	entry Pg	part No.	entry M
with lever, gasket and cover in plastic	CVI 10 LSP			
with lever and cover			CVP 10 LSP16 16	MVP 10 LSP20 20
with lever and cover, high construction			CVAP 10LSP21 21	MVAP 10LSP25 25
with lever and cover, high construction			CVAP 10LSP29 29	MVAP 10LSP32 32
with lever and cover, high construction				MVAP 10LSP40 40

☑ The enclosures ensure IP65 degree of protection when mated and locked with the closing lever, or IP44 protection when not mated and locked with lever, thanks to the SIMPLEX self-closing cover.

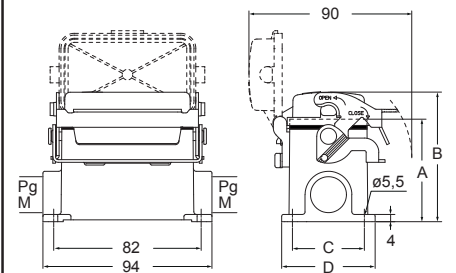
panel cut-out for bulkhead mounting housings



CVI LSP



CVP - CVAP LSP and MVP - MVAP LSP



type	A	B	C	D
CVP / MVP 10 LSP	57	72	40	52
CVAP / MVAP 10 LSP	74	89	45	57

Hoods (from page 395)



CRUS Type 4/4X/12



CRUS Type 4/4X/12 pending



CV and MV V-TYPE lever version

inserts		page:
CDD	42 poles + ⊕	78
CDS	18 poles + ⊕	-
CDSH	18 poles + ⊕	87
CNE	10 poles + ⊕	111
CSE	10 poles + ⊕	-
CSH	10 poles + ⊕	111
CSH S	10 poles + ⊕	123
CCE	10 poles + ⊕	131
CMSH	3+2 (aux) poles + ⊕	136
CMCE	3+2 (aux) poles + ⊕	137
CSS	10 poles + ⊕	149
CQE	18 poles + ⊕	169
CX	8/24 poles + ⊕	194
MIXO	3 modules	262 - 317

angled bulkhead mounting housings with stainless steel single lever



angled bulkhead mounting housings with stainless steel single lever



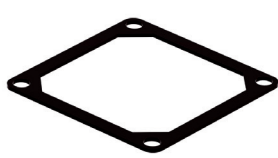
description	part No.	part No.	entry
-------------	----------	----------	-------

with lever, without cable gland entry ^{1) 3)} **CVI 10 LA**

with lever, with cable gland entry, closed bulkhead ²⁾ **MVI 10 LAP32 32**

¹⁾ Flange gasket to be purchased separately.
part No.: **CR 10 MO**.

CR 10 MO
gasket



Following flange versions available on request:
73 x 73, 78 x 78, 80 x 80, 98 x 98 mm

- ²⁾ Be used only with a complete cable gland (to be purchased separately).
Versions with M 25 or Pg 21 entry on request.
- ³⁾ Kit with earthing contact, comprising a special screw and wire-terminals for 6 mm² earthing conductors (for the additional connection of the upper enclosure half) part No.: **CR MOT**.

CR MOT
kit

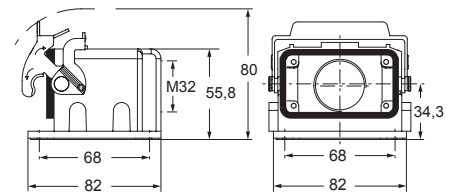
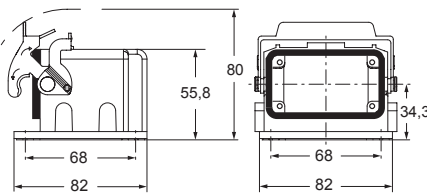


The enclosures ensure IP65 degree of protection when mated and locked with the closing lever.

Hoods
(from page 395)



CAIUS® Type
4/4X/12



V-TYPE IP65/IP66

CV - CVA and MV - MVA V-TYPE lever version

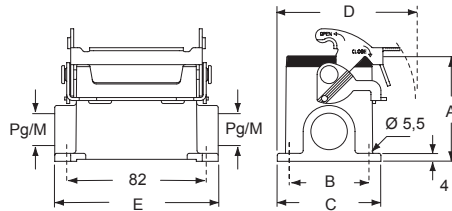
inserts		page:
CDD	42 poles + ⊕	78
CDS	18 poles + ⊕	-
CDSH	18 poles + ⊕	87
CNE	10 poles + ⊕	111
CSE	10 poles + ⊕	-
CSH	10 poles + ⊕	111
CSH S	10 poles + ⊕	123
CCE	10 poles + ⊕	131
CMSH	3+2 (aux) poles + ⊕	136
CMCE	3+2 (aux) poles + ⊕	137
CSS	10 poles + ⊕	149
CQE	18 poles + ⊕	169
CX	8/24 poles + ⊕	194
MIXO	3 modules	262 - 317

surface mounting housings with single lever in stainless steel



description	part No.	entry Pg	part No	entry M
with lever, size "57.27"	CVP 10 L	16	MVP 10 L20	20
with lever, size "57.27"	CVP 10 L2	16 x 2	MVP 10 L220	20 x 2
with lever, high construction, size "57.27"	CVAP 10 L21	21	MVAP 10 L32	32
with lever, high construction, size "57.27"	CVAP 10 L221	21 x 2	MVAP 10 L232	32 x 2
with lever, high construction, size "57.27"	CVAP 10 L29	29	MVAP 10 L40	40
with lever, high construction, size "57.27"	CVAP 10 L229	29 x 2	MVAP 10 L240	40 x 2

CVP L - CVAP L and MVP L - MVAP L



type	A	B	C	D	E
CVP/MVP 10 L	57	40	52	73	93,5
CVAP/MVAP 10 L	74	45	57	75,5	94

Hoods
(from page 395)



CAUS® Type
4/4X/12

insulating cable gland or fittings
without gasket

cable gland
with O-Ring gasket

CV - CVA and MV - MVA V-TYPE lever version

inserts		page:
CDD	42 poles + ⊕	78
CDS	18 poles + ⊕	-
CDSH	18 poles + ⊕	87
CNE	10 poles + ⊕	111
CSE	10 poles + ⊕	-
CSH	10 poles + ⊕	111
CSH S	10 poles + ⊕	123
CCE	10 poles + ⊕	131
CMSH	3+2 (aux) poles + ⊕	136
CMCE	3+2 (aux) poles + ⊕	137
CSS	10 poles + ⊕	149
CQE	18 poles + ⊕	169
CX	8/24 poles + ⊕	194
MIXO	3 modules	262 - 317

surface mounting housings with stainless steel single lever and plastic cover



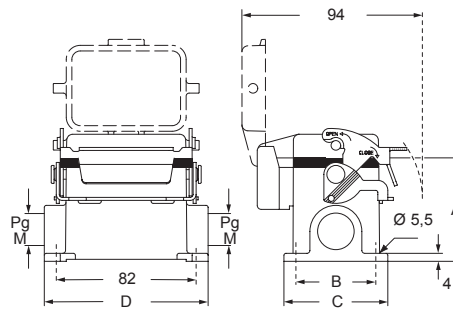
surface mounting housings with stainless steel single lever and aluminium cover



description	part No.	entry Pg	part No	entry M	part No.	entry Pg	part No.	entry M
	with lever and cover, size "57.27"	CVP 10 LP	16	MVP 10 LP20	20	CVP 10 LS	16	MVP 10 LS20
with lever and cover, size "57.27"	CVP 10 LP2	16 x 2	MVP 10 LP220	20 x 2	CVP 10 LS2	16 x 2	MVP 10 LS220	20 x 2
with lever and cover, high construction, size "57.27"	CVAP 10 LP21	21	MVAP 10 LP32	32	CVAP 10 LS	21	MVAP 10 LS32	32
with lever and cover, high construction, size "57.27"	CVAP 10LP221	21 x 2	MVAP 10LP232	32 x 2	CVAP 10 LS2	21 x 2	MVAP 10LS232	32 x 2
with lever and cover, high construction, size "57.27"	CVAP 10 LP29	29	MVAP 10 LP40	40	CVAP 10 LS29	29	MVAP 10 LS40	40
with lever and cover, high construction, size "57.27"	CVAP 10LP229	29 x 2	MVAP 10LP240	40 x 2	CVAP 10LS229	29 x 2	MVAP 10LS240	40 x 2

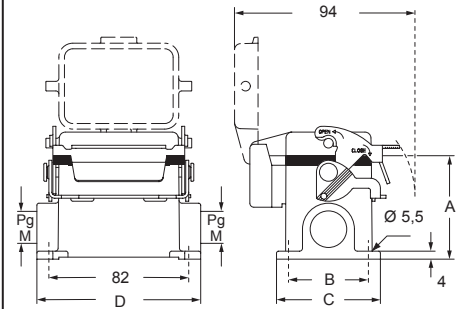
☑ The enclosures ensure IP66 (or IP65 cover versions) degree of protection when mated and locked with the closing levers.

CVP LP - CVAP LP and MVP LP - MVAP LP



type	A	B	C	D
CVP/MVP 10 LP	57	40	52	93,5
CVAP/MVAP 10 LP	74	45	57	94

CVP LS - CVAP LS and MVP LS - MVAP LS



type	A	B	C	D
CVP/MVP 10 LS	57	40	52	93,5
CVAP/MVAP 10 LS	74	45	57	94

Hoods
(from page 395)



CAVUS® Type 4/4X/12
(except enclosures with plastic cover)



V-TYPE IP65/IP66

CV - CVA - CVF and MV - MVA - MVF V-TYPE lever version

inserts		page:
CDD	42 poles + ⊕	78
CDS	18 poles + ⊕	-
CDSH	18 poles + ⊕	87
CNE	10 poles + ⊕	111
CSE	10 poles + ⊕	-
CSH	10 poles + ⊕	111
CSH S	10 poles + ⊕	123
CCE	10 poles + ⊕	131
CMSH	3+2 (aux) poles + ⊕	136
CMCE	3+2 (aux) poles + ⊕	137
CSS	10 poles + ⊕	149
CQE	18 poles + ⊕	169
CX	8/24 poles + ⊕	194
MIXO	3 modules	262 - 317

hoods, top entry, with gasket and stainless steel single lever



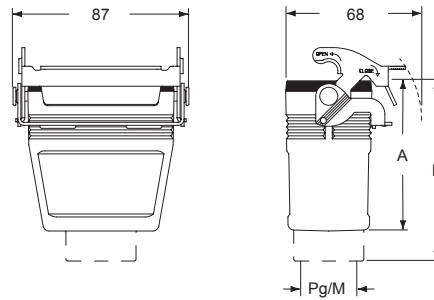
hoods, top entry, with gasket and 2 levers in stainless steel



description	part No.	entry Pg	part No.	entry M	part No.	entry Pg	part No.	entry M
with lever/s, size "57.27"	CVV 10 LG	16	MVV 10 LG25	25	CVV 10 G	16	MVV 10 G25	25
with lever/s, high construction, size "57.27"	CVAV 10 LG21	21	MVAV 10 LG25	25	CVAV 10 G21	21	MVAV 10 G25	25
with lever/s, high construction, size "57.27"	CVAV 10 LG29	29	MVAV 10 LG32	32	CVAV 10 G29	29	MVAV 10 G32	32
with lever/s, high construction, without adapter, size "57.27" 1)	CVFV 10 LG21	21	MVFV 10 LG25	25	CVFV 10 G21	21	MVFV 10 G25	25
with lever/s, high construction, without adapter, size "57.27" 1)	CVFV 10 LG29	29	MVFV 10 LG32	32	CVFV 10 G29	29	MVFV 10 G32	32

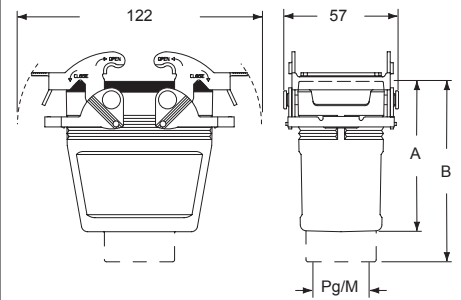
1) enclosure without adapter, threaded on the body, to be used only with a complete cable gland.

CVV LG - CVAV LG - CVFV LG and MVV LG - MVAV LG - MVFV LG



type	A	B
CVV/MVV 10 LG	50,5	63,5
CVAV/MVAV 10 LG	75	91
CVFV/MVFV 10 LG	75	-

CVV G - CVAV G - CVFV G and MVV G - MVAV G - MVFV G



type	A	B
CVV/MVV 10 G	50,5	63,5
CVAV/MVAV 10 G	75	91
CVFV/MVFV 10 G	75	-

Hoods
(from page 395)



CAU® Type
4/4X/12

insulating cable gland or fittings
without gasket

cable gland
with O-Ring gasket

CV V-TYPE lever version

inserts		page:
CD	40 poles + ⊕	70
CDD	72 poles + ⊕	79
CDS	27 poles + ⊕	-
CDSH	27 poles + ⊕	88
CNE	16 poles + ⊕	112
CSE	16 poles + ⊕	-
CSH	16 poles + ⊕	112
CSH S	16 poles + ⊕	124
CCE	16 poles + ⊕	132
CMSH, CMCE	6+2 (aux) poles + ⊕	138 - 139
CSS	16 poles + ⊕	150
CT, CTS (10A) *)	40 poles + ⊕	156
CT, CTSE (16A) *)	16 poles + ⊕	162
CQE	32 poles + ⊕	170
CQEE	40 poles + ⊕	176
CP	6 poles + ⊕	178
CX	6/12, 6/36 and 12/2 poles + ⊕	197 - 199
CX	4/0 and 4/2 poles + ⊕	200 - 201
MIXO	4 modules	262 - 317

*) can be used only in bulkhead mounting housings

bulkhead mounting housings with single lever in stainless steel



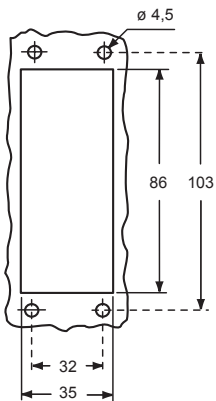
bulkhead mounting housings with single lever in stainless steel



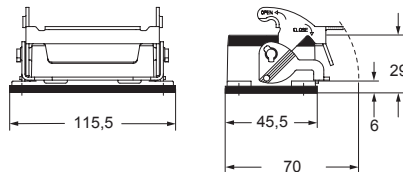
description	part No.	part No.
with lever and gasket, size "77.27"	CVI 16 L	
with lever, gasket and cover in aluminium, size "77.27"		CVI 16 LS
with lever, gasket and cover in plastic, size "77.27"		CVI 16 LP

☑ The enclosures ensure IP66/IP69 (or IP65 cover versions) degree of protection when mated and locked with the closing levers.

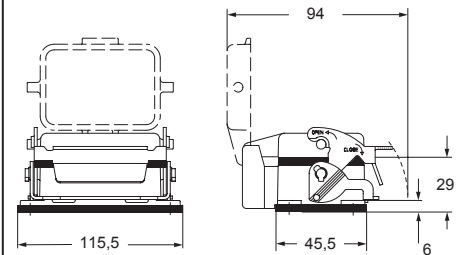
panel cut-out for bulkhead mounting housings



CVI L



CVI LS/LP



Hoods
(from page 404)



CVI® US Type 4/4X/12



CVI® US Type 4/4X/12
(except enclosures with plastic cover)



CV - CVA and MV - MVA V-TYPE lever SIMPLEX self-closing covers

inserts		page:
CD	40 poles + ⊕	70
CDD	72 poles + ⊕	79
CDS	27 poles + ⊕	-
CDSH	27 poles + ⊕	88
CNE	16 poles + ⊕	112
CSE	16 poles + ⊕	-
CSH	16 poles + ⊕	112
CSH S	16 poles + ⊕	124
CCE	16 poles + ⊕	132
CMSH, CMCE	6+2 (aux) poles + ⊕	138 - 139
CSS	16 poles + ⊕	150
CT, CTS (10A) *)	40 poles + ⊕	156
CT, CTSE (16A) *)	16 poles + ⊕	162
CQE	32 poles + ⊕	170
CQEE	40 poles + ⊕	176
CP	6 poles + ⊕	178
CX	6/12, 6/36 and 12/2 poles + ⊕	197 - 199
CX	4/0 and 4/2 poles + ⊕	200 - 201
MIXO	4 modules	262 - 317

*) can be used only in bulkhead mounting housings

bulkhead mounting housings with stainless steel single lever



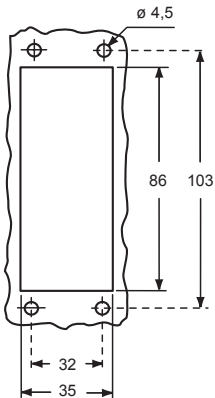
surface mounting housings with stainless steel single lever



description	part No.	entry Pg	part No.	entry M
with lever, gasket and cover in plastic	CVI 16 LSP			
with lever and cover			CVP 16 LSP21 21	MVP 16 LSP25 25
with lever and cover, high construction			CVAP 16LSP21 21	MVAP 16LSP25 25
with lever and cover, high construction			CVAP 16LSP29 29	MVAP 16LSP32 32
with lever and cover, high construction				MVAP 16LSP40 40

The enclosures ensure IP65 degree of protection when mated and locked with the closing lever, or IP44 protection when not mated and locked with lever, thanks to the SIMPLEX self-closing cover.

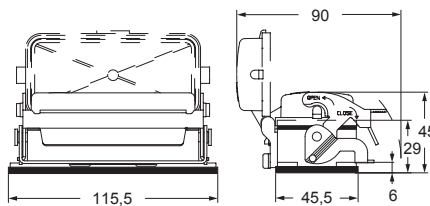
panel cut-out for bulkhead mounting housings



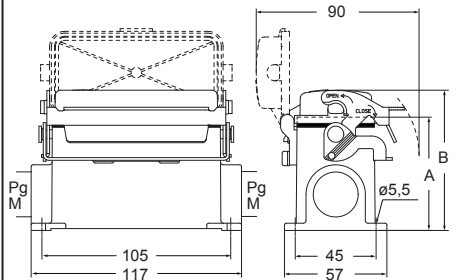
Hoods (from page 404)



CVI LSP



CVP - CVAP LSP and MVP - MVAP LSP



part No.	A	B
CVP / MVP 16 LSP	63	78
CVAP / MVAP 16 LSP	81	96

CRUS Type 4/4X/12



CRUS Type 4/4X/12 pending



CV - CVA and MV - MVA V-TYPE lever version

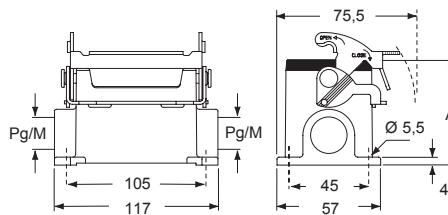
inserts		page:
CD	40 poles + ⊕	70
CDD	72 poles + ⊕	79
CDS	27 poles + ⊕	-
CDSH	27 poles + ⊕	88
CNE	16 poles + ⊕	112
CSE	16 poles + ⊕	-
CSH	16 poles + ⊕	112
CSH S	16 poles + ⊕	124
CCE	16 poles + ⊕	132
CMSH, CMCE	6+2 (aux) poles + ⊕	138 - 139
CSS	16 poles + ⊕	150
CQE	32 poles + ⊕	170
CQEE	40 poles + ⊕	176
CP	6 poles + ⊕	178
CX	6/12, 6/36 and 12/2 poles + ⊕	197 - 199
CX	4/0 and 4/2 poles + ⊕	200 - 201
MIXO	4 modules	262 - 317

surface mounting housings with single lever in stainless steel



description	part No.	entry Pg	part No	entry M
with lever, size "77.27"	CVP 16 L	21	MVP 16 L25	25
with lever, size "77.27"	CVP 16 L2	21 x 2	MVP 16 L225	25 x 2
with lever, high construction, size "77.27"	CVAP 16 L21	21	MVAP 16 L32	32
with lever, high construction, size "77.27"	CVAP 16 L221	21 x 2	MVAP 16 L232	32 x 2
with lever, high construction, size "77.27"	CVAP 16 L29	29	MVAP 16 L40	40
with lever, high construction, size "77.27"	CVAP 16 L229	29 x 2	MVAP 16 L240	40 x 2

CVP L - CVAP L and MVP L - MVAP L



type	A
CVP/MVP 16 L	63
CVAP/MVAP 16 L	81

Hoods
(from page 404)



CAUS® Type
4/4X/12



insulating cable gland or fittings without gasket



cable gland with O-Ring gasket

CV - CVA and MV - MVA V-TYPE lever version

inserts		page:
CD	40 poles + ⊕	70
CDD	72 poles + ⊕	79
CDS	27 poles + ⊕	-
CDSH	27 poles + ⊕	88
CNE	16 poles + ⊕	112
CSE	16 poles + ⊕	-
CSH	16 poles + ⊕	112
CSH S	16 poles + ⊕	124
CCE	16 poles + ⊕	132
CMSH, CMCE	6+2 (aux) poles + ⊕	138 - 139
CSS	16 poles + ⊕	150
CQE	32 poles + ⊕	170
CQEE	40 poles + ⊕	176
CP	6 poles + ⊕	178
CX	6/12, 6/36 and 12/2 poles + ⊕	197 - 199
CX	4/0 and 4/2 poles + ⊕	200 - 201
MIXO	4 modules	262 - 317

surface mounting housings with single lever in stainless steel and plastic cover



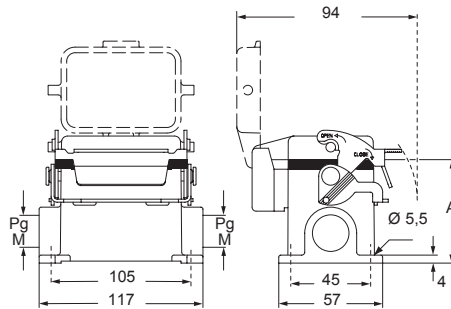
surface mounting housings with single lever in stainless steel and aluminium cover



description	part No.	entry Pg	part No.	entry M	part No.	entry Pg	part No.	entry M
with lever and cover, size "77.27"	CVP 16 LP	21	MVP 16 LP25	25	CVP 16 LS	21	MVP 16 LS25	25
with lever and cover, size "77.27"	CVP 16 LP2	21 x 2	MVP 16 LP225	25 x 2	CVP 16 LS2	21 x 2	MVP 16 LS225	25 x 2
with lever and cover, high construction, size "77.27"	CVAP 16 LP21	21	MVAP 16 LP32	32	CVAP 16 LS	21	MVAP 16 LS32	32
with lever and cover, high construction, size "77.27"	CVAP 16LP221	21 x 2	MVAP 16LP232	32 x 2	CVAP 16 LS2	21 x 2	MVAP 16LS232	32 x 2
with lever and cover, high construction, size "77.27"	CVAP 16 LP29	29	MVAP 16 LP40	40	CVAP 16 LS29	29	MVAP 16 LS40	40
with lever and cover, high construction, size "77.27"	CVAP 16LP229	29 x 2	MVAP 16LP240	40 x 2	CVAP 16LS229	29 x 2	MVAP 16LS240	40 x 2

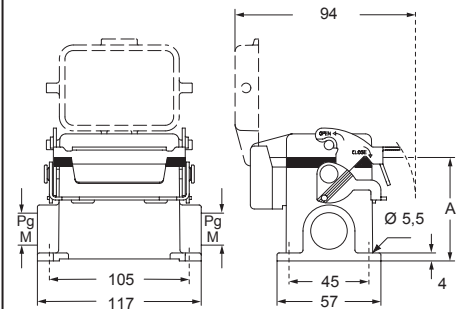
☑ The enclosures ensure IP66 (or IP65 cover versions) degree of protection when mated and locked with the closing levers.

CVP LP - CVAP LP and MVP LP - MVAP LP



type	A
CVP/MVP 16 LP	63
CVAP/MVAP 16 LP	81

CVP LS - CVAP LS and MVP LS - MVAP LS



type	A
CVP/MVP 16 LS	63
CVAP/MVAP 16 LS	81

Hoods
(from page 404)



CAVUS® Type
4/4X/12
(except enclosures with plastic cover)



CV - CVA - CVF and MV - MVA - MVF V-TYPE lever version

inserts		page:
CD	40 poles + ⊕	70
CDD	72 poles + ⊕	79
CDS	27 poles + ⊕	-
CDSH	27 poles + ⊕	88
CNE	16 poles + ⊕	112
CSE	16 poles + ⊕	-
CSH	16 poles + ⊕	112
CSH S	16 poles + ⊕	124
CCE	16 poles + ⊕	132
CMSH, CMCE	6+2 (aux) poles + ⊕	138 - 139
CSS	16 poles + ⊕	150
CQE	32 poles + ⊕	170
CQEE	40 poles + ⊕	176
CP	6 poles + ⊕	178
CX	6/12, 6/36 and 12/2 poles + ⊕	197 - 199
CX	4/0 and 4/2 poles + ⊕	200 - 201
MIXO	4 modules	262 - 317

**hoods, top entry,
with gasket and single lever in stainless steel**



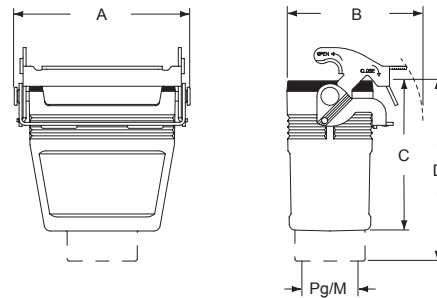
**hoods, top entry,
with gasket and 2 levers in stainless steel**



description	part No.	entry Pg	part No	entry M	part No.	entry Pg	part No.	entry M
with lever/s, size "77.27"	CVV 16 LG	21	MVV 16 LG32	32	CVV 16 G	21	MVV 16 G32	32
with lever/s, high construction, size "77.27"	CVAV 16 LG21	21	MVAV 16 LG25	25	CVAV 16 G21	21	MVAV 16 G25	25
with lever/s, high construction, size "77.27"	CVAV 16 LG29	29	MVAV 16 LG32	32	CVAV 16 G29	29	MVAV 16 G32	32
with lever/s, high construction, without adapter, size "77.27" 1)	CVFV 16 LG21	21	MVFV 16 LG25	25	CVFV 16 G21	21	MVFV 16 G25	25
with lever/s, high construction, without adapter, size "77.27" 1)	CVFV 16 LG29	29	MVFV 16 LG32	32	CVFV 16 G29	29	MVFV 16 G32	32

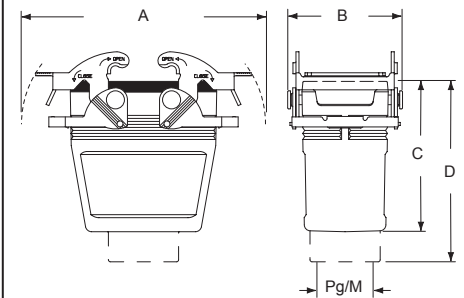
1) enclosure without adapter, threaded on the body, to be used only with a complete cable gland.

**CVV LG - CVAV LG - CVFV LG and
MVV LG - MVAV LG - MVFV LG**



type	A	B	C	D
CVV/MVV 16 LG	107,5	68	50,5	63,5
CVAV/MVAV 16 LG	107,5	68	81	97
CVFV/MVFV 16 LG	107,5	68	81	-

**CVV G - CVAV G - CVFV G and
MVV G - MVAV G - MVFV G**



type	A	B	C	D
CVV/MVV 16 G	142,5	57	50,5	63,5
CVAV/MVAV 16 G	142,5	57	81	97
CVFV/MVFV 16 G	142,5	57	81	-

Hoods
(from page 404)



CAU[®] US Type
4/4X/12



insulating cable gland or fittings
without gasket



cable gland
with O-Ring gasket

V-TYPE IP65/IP66

CV V-TYPE lever version

inserts		page:
CD	64 poles + ⊕	72
CDD	108 poles + ⊕	81
CDS	42 poles + ⊕	-
CDSH	42 poles + ⊕	89
CNE	24 poles + ⊕	113
CSE	24 poles + ⊕	-
CSH	24 poles + ⊕	113
CSH S	24 poles + ⊕	125
CCE	24 poles + ⊕	133
CMSH	10+2 (aux) poles + ⊕	140
CMCE	10+2 (aux) poles + ⊕	141
CSS	24 poles + ⊕	151
CT, CTS (10A) *	64 poles + ⊕	157
CT, CTSE (16A) *	24 poles + ⊕	163
CQE	46 poles + ⊕	171
CQEE	64 poles + ⊕	177
CX	4/8 and 6/6 poles + ⊕	204, 206
MIXO	6 modules	262 - 317

*) can be used only in bulkhead mounting housings

bulkhead mounting housings with single lever in stainless steel



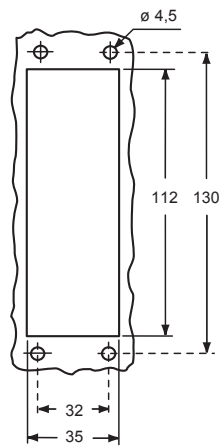
bulkhead mounting housings with single lever in stainless steel



description	part No.	part No.
with lever and gasket, size "104.27"	CVI 24 L	
with lever, gasket and cover in aluminium, size "104.27"		CVI 24 LS
with lever, gasket and cover in plastic, size "104.27"		CVI 24 LP

☑ The enclosures ensure IP66/IP69 (or IP65 cover versions) degree of protection when mated and locked with the closing levers.

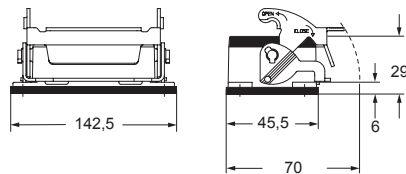
panel cut-out for bulkhead mounting housings



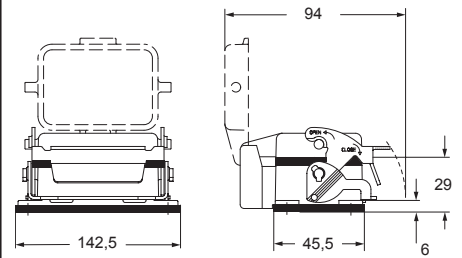
Hoods
(from page 414)



CVI L



CVI LS/LP



CAVUS Type 4/4X/12



CAVUS Type 4/4X/12
(except enclosures with plastic cover)



CV - CVA and MV - MVA V-TYPE lever SIMPLEX self-closing covers

inserts		page:
CD	64 poles + ⊕	72
CDD	108 poles + ⊕	81
CDS	42 poles + ⊕	-
CDSH	42 poles + ⊕	89
CNE	24 poles + ⊕	113
CSE	24 poles + ⊕	-
CSH	24 poles + ⊕	113
CSH S	24 poles + ⊕	125
CCE	24 poles + ⊕	133
CMSH	10+2 (aux) poles + ⊕	140
CMCE	10+2 (aux) poles + ⊕	141
CSS	24 poles + ⊕	151
CT, CTS (10A) *	64 poles + ⊕	157
CT, CTSE (16A) *	24 poles + ⊕	163
CQE	46 poles + ⊕	171
CQEE	64 poles + ⊕	177
CX	4/8 and 6/6 poles + ⊕	204, 206
MIXO	6 modules	262 - 317

*) can be used only in bulkhead mounting housings

bulkhead mounting housings with stainless steel single lever



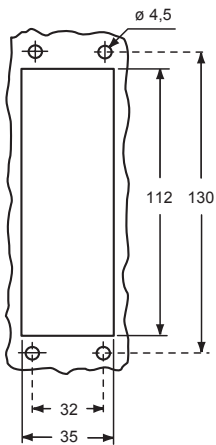
surface mounting housings with stainless steel single lever



description	part No.	part No.	entry Pg	part No.	entry M
with lever, gasket and cover in plastic	CVI 24 LSP				
with lever and cover		CVP 24 LSP21	21	MVP 24 LSP25	25
with lever and cover, high construction		CVAP 24LSP21	21	MVAP 24LSP25	25
with lever and cover, high construction		CVAP 24LSP29	29	MVAP 24LSP32	32
with lever and cover, high construction				MVAP 24LSP40	40

☑ The enclosures ensure IP65 degree of protection when mated and locked with the closing lever, or IP44 protection when not mated and locked with lever, thanks to the SIMPLEX self-closing cover.

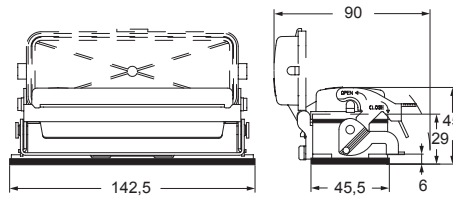
panel cut-out for bulkhead mounting housings



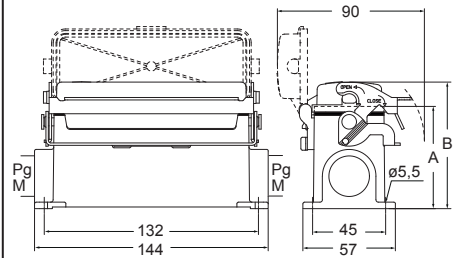
Hoods (from page 414)



CVI LSP



CVP - CVAP LSP and MVP - MVAP LSP



type	A	B
CVP / MVP 24 LSP	63	78
CVAP / MVAP 24 LSP	81	96

CAIUS Type 4/4X/12



CAIUS Type 4/4X/12 pending



CV - CVA and MV - MVA V-TYPE lever version

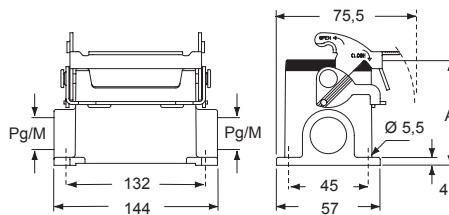
inserts		page:
CD	64 poles + ⊕	72
CDD	108 poles + ⊕	81
CDS	42 poles + ⊕	-
CDSH	42 poles + ⊕	89
CNE	24 poles + ⊕	113
CSE	24 poles + ⊕	-
CSH	24 poles + ⊕	113
CSH S	24 poles + ⊕	125
CCE	24 poles + ⊕	133
CMSH	10+2 (aux) poles + ⊕	140
CMCE	10+2 (aux) poles + ⊕	141
CSS	24 poles + ⊕	151
CQE	46 poles + ⊕	171
CQEE	64 poles + ⊕	177
CX	4/8 and 6/6 poles + ⊕	204, 206
MIXO	6 modules	262 - 317

surface mounting housings with single lever in stainless steel



description	part No.	entry Pg	part No	entry M
with lever, size "104.27"	CVP 24 L	21	MVP 24 L25	25
with lever, size "104.27"	CVP 24 L2	21 x 2	MVP 24 L225	25 x 2
with lever, high construction, size "104.27"	CVAP 24 L21	21	MVAP 24 L32	32
with lever, high construction, size "104.27"	CVAP 24 L221	21 x 2	MVAP 24 L232	32 x 2
with lever, high construction, size "104.27"	CVAP 24 L29	29	MVAP 24 L40	40
with lever, high construction, size "104.27"	CVAP 24 L229	29 x 2	MVAP 24 L240	40 x 2

CVP L - CVAP L and MVP L - MVAP L



type	A
CVP / MVP 24 L	63
CVAP / MVAP 24 L	81

Hoods (from page 414)



CAVUS Type 4/4X/12

insulating cable gland or fittings without gasket

cable gland with O-Ring gasket

CV - CVA and MV - MVA V-TYPE lever version

inserts		page:
CD	64 poles + ⊕	72
CDD	108 poles + ⊕	81
CDS	42 poles + ⊕	-
CDSH	42 poles + ⊕	89
CNE	24 poles + ⊕	113
CSE	24 poles + ⊕	-
CSH	24 poles + ⊕	113
CSH S	24 poles + ⊕	125
CCE	24 poles + ⊕	133
CMSH	10+2 (aux) poles + ⊕	140
CMCE	10+2 (aux) poles + ⊕	141
CSS	24 poles + ⊕	151
CQE	46 poles + ⊕	171
CQEE	64 poles + ⊕	177
CX	4/8 and 6/6 poles + ⊕	204, 206
MIXO	6 modules	262 - 317

surface mounting housings with single lever in stainless steel and plastic cover



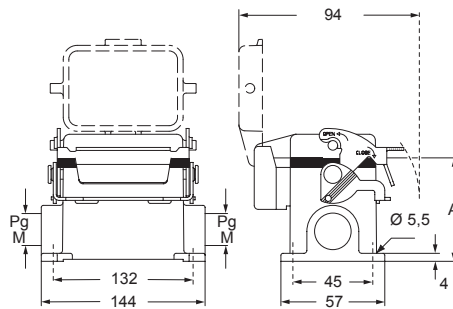
surface mounting housings with single lever in stainless steel and aluminium cover



description	part No.		entry Pg		part No.		entry M	
with lever and cover, size "104.27"	CVP 24 LP	21	MVP 24 LP25	25	CVP 24 LS	21	MVP 24 LS25	25
with lever and cover, size "104.27"	CVP 24 LP2	21 x 2	MVP 24 LP225	25 x 2	CVP 24 LS2	21 x 2	MVP 24 LS225	25 x 2
with lever and cover, high construction, size "104.27"	CVAP 24 LP21	21	MVAP 24 LP32	32	CVAP 24 LS	21	MVAP 24 LS32	32
with lever and cover, high construction, size "104.27"	CVAP 24LP221	21 x 2	MVAP 24LP232	32 x 2	CVAP 24 LS2	21 x 2	MVAP 24LS232	32 x 2
with lever and cover, high construction, size "104.27"	CVAP 24 LP29	29	MVAP 24 LP40	40	CVAP 24 LS29	29	MVAP 24 LS40	40
with lever and cover, high construction, size "104.27"	CVAP 24LP229	29 x 2	MVAP 24LP240	40 x 2	CVAP 24LS229	29 x 2	MVAP 24LS240	40 x 2

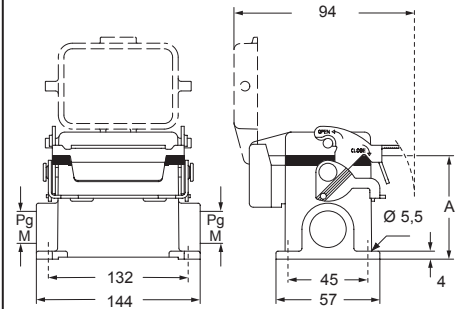
☑ The enclosures ensure IP66 (or IP65 cover versions) degree of protection when mated and locked with the closing levers.

CVP LP - CVAP LP and MVP LP - MVAP LP



type	A
CVP/MVP 24 LP	63
CVAP/MVAP 24 LP	81

CVP LS - CVAP LS and MVP LS - MVAP LS



type	A
CVP/MVP 24 LS	63
CVAP/MVAP 24 LS	81

Hoods
(from page 414)



CAVUS® Type
4/4X/12
(except enclosures with plastic cover)



V-TYPE IP65/IP66

CV - CVA - CVF and MV - MVA - MVF V-TYPE lever version

inserts		page:
CD	64 poles + ⊕	72
CDD	108 poles + ⊕	81
CDS	42 poles + ⊕	-
CDSH	42 poles + ⊕	89
CNE	24 poles + ⊕	113
CSE	24 poles + ⊕	-
CSH	24 poles + ⊕	113
CSH S	24 poles + ⊕	125
CCE	24 poles + ⊕	133
CMSH	10+2 (aux) poles + ⊕	140
CMCE	10+2 (aux) poles + ⊕	141
CSS	24 poles + ⊕	151
CQE	46 poles + ⊕	171
CQEE	64 poles + ⊕	177
CX	4/8 and 6/6 poles + ⊕	204, 206
MIXO	6 modules	262 - 317

hoods, top entry, with gasket and single lever in stainless steel



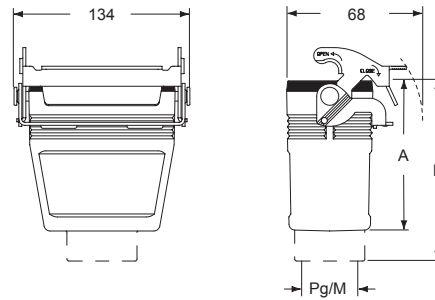
hoods, top entry, with gasket and 2 levers in stainless steel



description	part No.	entry Pg	part No.	entry M	part No.	entry Pg	part No.	entry M
with lever/s, size "104.27"	CVV 24 LG	21	MVV 24 LG32	32	CVV 24 G	21	MVV 24 G32	32
with lever/s, high construction, size "104.27"	CVAV 24 LG21	21	MVAV 24 LG25	25	CVAV 24 G21	21	MVAV 24 G25	25
with lever/s, high construction, size "104.27"	CVAV 24 LG29	29	MVAV 24 LG32	32	CVAV 24 G29	29	MVAV 24 G32	32
with lever/s, high construction, without adapter, size "104.27" 1)	CVFV 24 LG21	21	MVFV 24 LG25	25	CVFV 24 G21	21	MVFV 24 G25	25
with lever/s, high construction, without adapter, size "104.27" 1)	CVFV 24 LG29	29	MVFV 24 LG32	32	CVFV 24 G29	29	MVFV 24 G32	32

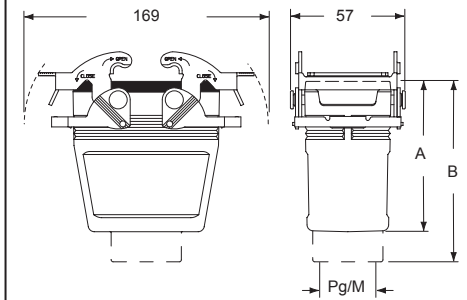
1) enclosure without adapter, threaded on the body, to be used only with a complete cable gland.

CVV LG - CVAV LG - CVFV LG and MVV LG - MVAV LG - MVFV LG



type	A	B
CVV/MVV 24 LG	60,5	73,5
CVAV/MVAV 24 LG	81	97
CVFV/MVFV 24 LG	81	-

CVV G - CVAV G - CVFV G and MVV G - MVAV G - MVFV G



type	A	B
CVV/MVV 24 G	60,5	73,5
CVAV/MVAV 24 G	81	97
CVFV/MVFV 24 G	81	-

Hoods
(from page 414)



CAVUS Type
4/4X/12



insulating cable gland or fittings
without gasket



cable gland
with O-Ring gasket

The space you have always needed

BIG Series, based on the wide-ranging experience achieved by ILME, introduces a significant **change in the design of hoods and has been specifically designed to meet the new requirements of the wiring market**. The enclosures **integrate the existing range and are ideal for installations with structured and complex wiring**.



Accurate design

The **large dimensions** of these innovative enclosures have been chosen to offer customers an **adequate space to store conductors**.

The **width** of the enclosures is **greater than that of previous versions**: 66 mm compared to the 43 mm for standard enclosures. The **height** of BIG enclosures has also been **increased to 100 mm** for sizes "44.27" and "57.27" (standard versions for high models: 70 and 72mm), **and to 110 mm** for sizes "77.27" and "104.27" (standard versions for high models: 76 mm).

The cable compartment is now fully accessible during assembly (the connector insert is fully inserted in the lower half of

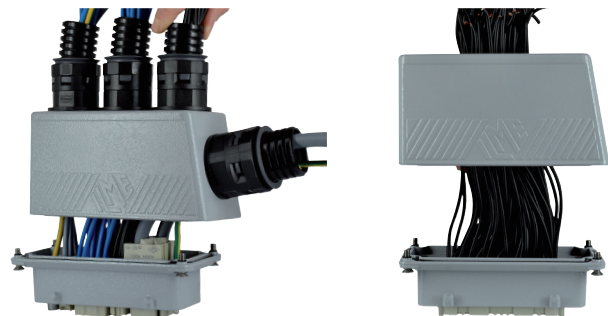
the enclosure), **offering three times the space compared to standard enclosures**. This means it is possible to bend cables and pipes with greater bending radii.

Due to this important feature, the BIG enclosures are **particularly suitable for MIXO modular inserts**, being versatile and customizable, for multiple cable entries.

Each insert, differentiated according to electric power or signal, pneumatic, optical fibre or Ethernet network current, **may thus have the specific branching. One single large connector can replace what previously required two connectors**.

Ease of use

The possibility of **splitting the enclosure in two halves simplifies the installation of the insert**. It is also possible to **connect the insert with a cable and later insert it in the lower half of the enclosure** (except for the 6 pole version).



Options for the connection of control and signalling devices

All the five walls of the upper half of the enclosure have a high thickness to allow them to be drilled and threaded, even with multiple threads.

BIG enclosures enable the connection – of push – buttons, selectors, switches and signalling lamps after the necessary holes have been drilled. It is possible, for example, to enable power supplies or signalling circuits, even after the connector has been coupled.

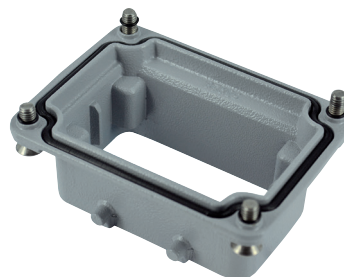


Simplified installation

Installation operations for the hoods are simple and fast. No special accessories, tools or expensive additional operations are required.

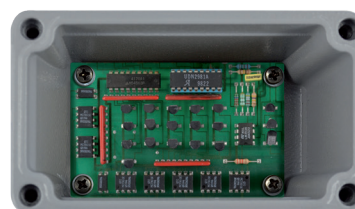
The lower half of the enclosure must be fixed to the upper half by means of the 4 screws supplied.

It is possible to prevent the fixing screws from coming loose by fitting on each screw the O-ring seal supplied with the enclosures.



Compartment for electronic boards

It is possible to install electronic boards in the upper section of enclosures with side entry. In this case, it is however necessary to order CR MBS screws separately to fix the board in place.



Greater protection

It is also possible to fix one earthing terminal in the upper half of the enclosure to provide protection against indirect contacts.

In this case, it is however necessary to order separately earthing terminal CR MBT, consisting of a fixing screws and a wire-terminal for 6 mm² conductors.



Range

The items are classified with the following pre-code:

- MBO for enclosures with side entry
- MBV for enclosures with one or more top entries
- MBVO for enclosures with top and side entries
- CBC for closed enclosures that can be drilled

The available versions are:

- for enclosures with size "44.27": **single lever**
- for enclosures with sizes "57.27", "72.27" and "104.27": **two levers**

SUM-UP

- ☑ **The BIG enclosures are made in die-cast aluminum alloy and are fitted with cast pegs with a reinforced design, painted with epoxy-polyester powder paint. The sealing gasket in anti-aging NBR elastomer, resistant to oils and fuels, is positioned internally to guarantee a greater protection from light and atmospheric agents**
- ☑ **BIG enclosures guarantee an IP66 protection rating (EN 60529) after the connector has been coupled, and completed with appropriate cable glands; they are manufactured in compliance with standard IEC/EN 61984**
- ☑ **Ambient temperature range -40°C / +125°C**
- ☑ **Versions for class W aggressive environments are also available on request**

Q WARNING:

Due to the considerable weight of BIG hoods, when fitted with inserts, conductors and cable glands, we recommend to use them in combination with housings fitted with V-TYPE closing levers (C7/M7/CV/MV).

If used in combination with enclosures series CLASS, it is advisable to appropriately anchor the cables in order to prevent their weight from being applied to the closing levers.

MB wider version BIG

inserts		page:
CDD	24 poles + ⊕	76
CDS	9 poles + ⊕	-
CDSH	9 poles + ⊕	86
CDSH NC	6 poles + ⊕	95
CNE	6 poles + ⊕	110
CSE	6 poles + ⊕	-
CSH	6 poles + ⊕	110
CSH S	6 poles + ⊕	122
CCE	6 poles + ⊕	130
CSS	6 poles + ⊕	148
CT, CTSE (16A)	6 poles + ⊕	160
CQE	10 poles + ⊕	168
MIXO	2 modules	262 - 317

hoods with 2 pegs

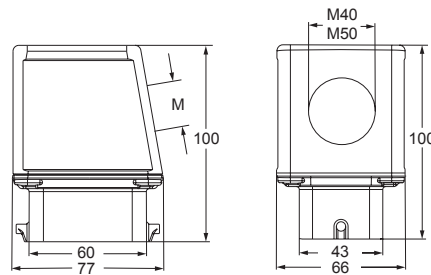


hoods with 2 pegs

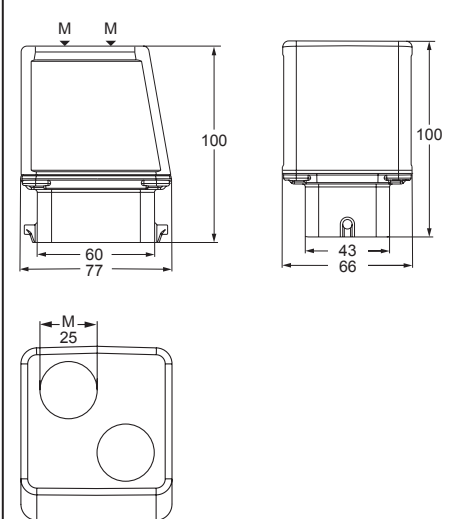


description	part No.	entry	part No.	entry
		M		M
with pegs, side entry	MBO 06 L40	40		
with pegs, side entry	MBO 06 L50	50		
with pegs, top entry	MBV 06 L40	40	MBV 06 L225	25 x 2
with pegs, top entry	MBV 06 L50	50	MBV 06 L320	20 x 3

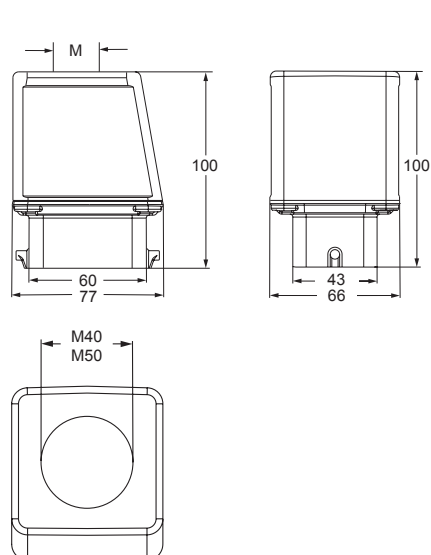
MBO 06 L



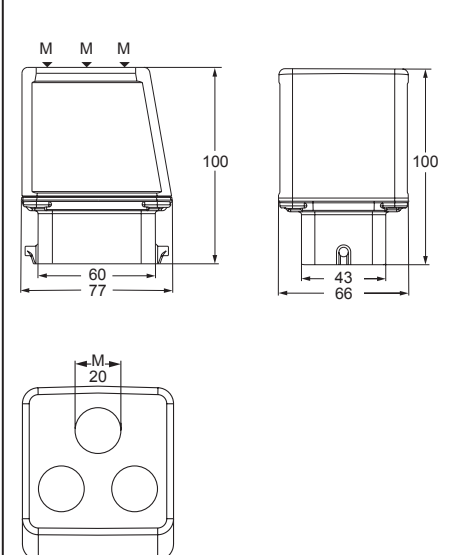
MBV 06 L225



MBV 06 L




MBV 06 L320




Housings
(page 436)



CAVUS® Type 4/4X/12

 insulating cable gland or fittings without gasket

 cable gland with O-Ring gasket

CB and MB wider version BIG

inserts		page:
CDD	24 poles + ⊕	76
CDS	9 poles + ⊕	-
CDSH	9 poles + ⊕	86
CDSH NC	6 poles + ⊕	95
CNE	6 poles + ⊕	110
CSE	6 poles + ⊕	-
CSH	6 poles + ⊕	110
CSH S	6 poles + ⊕	122
CCE	6 poles + ⊕	130
CSS	6 poles + ⊕	148
CT, CTSE (16A)	6 poles + ⊕	160
CQE	10 poles + ⊕	168
MIXO	2 modules	262 - 317

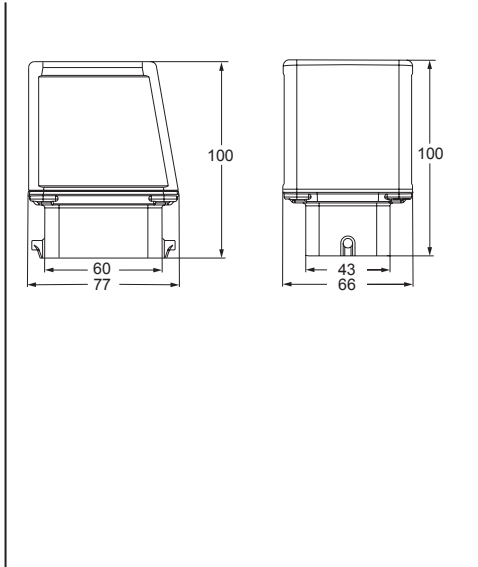
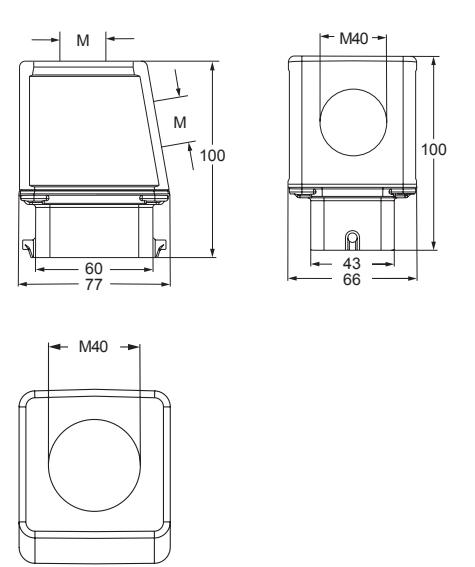
hoods with 2 pegs



hoods with 2 pegs



description	part No.	entry M	part No.
with pegs, side and top entries	MBVO 06 L240	2 x 40	
with pegs, without entries, designed to be drilled			CBC 06 L



Housings
(page 436)



CAVUS® Type 4/4X/12

insulating cable gland or fittings without gasket

cable gland with O-Ring gasket

MB wider version BIG

inserts		page:
CDD	42 poles + ⊕	78
CDS	18 poles + ⊕	-
CDSH	18 poles + ⊕	87
CNE	10 poles + ⊕	111
CSE	10 poles + ⊕	-
CSH	10 poles + ⊕	111
CSH S	10 poles + ⊕	123
CCE	10 poles + ⊕	131
CMSH	3+2 (aux) poles + ⊕	136
CMCE	3+2 (aux) poles + ⊕	137
CSS	10 poles + ⊕	149
CT, CTSE (16A)	10 poles + ⊕	161
CQE	18 poles + ⊕	169
CX	8/24 poles + ⊕	194
MIXO	3 modules	262 - 317

hoods with 4 pegs

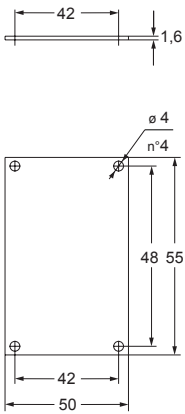


hoods with 4 pegs

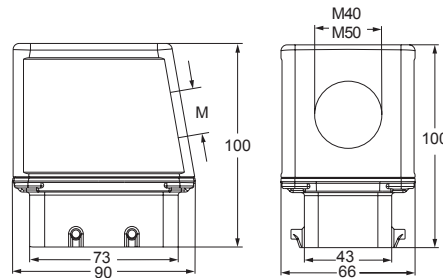


description	part No.	entry	part No.	entry
		M		M
with pegs, side entry	MBO 10.40	40		
with pegs, side entry	MBO 10.50	50		
with pegs, top entry	MBV 10.40	40	MBV 10.225	25 x 2
with pegs, top entry	MBV 10.50	50	MBV 10.420	20 x 4

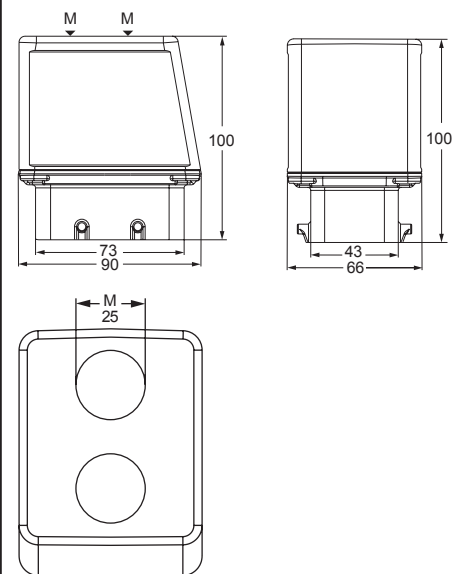
dimensions of electronic boards for MBO enclosures side entry



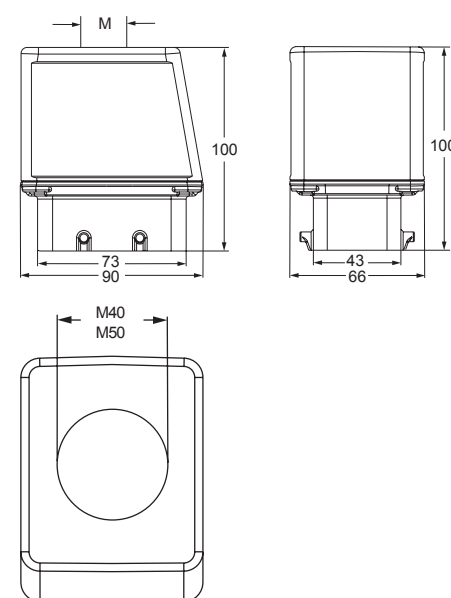
MBO 10



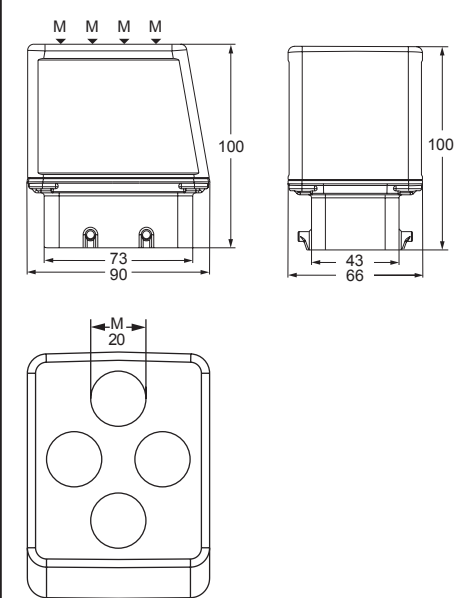
MBV 10.225



MBV 10



MBV 10.240



Housings (page 438)



CAVUS Type 4/4X/12



insulating cable gland or fittings without gasket



cable gland with O-Ring gasket

CB and MB wider version BIG

inserts		page:
CDD	42 poles + ⊕	78
CDS	18 poles + ⊕	-
CDSH	18 poles + ⊕	87
CNE	10 poles + ⊕	111
CSE	10 poles + ⊕	-
CSH	10 poles + ⊕	111
CSH S	10 poles + ⊕	123
CCE	10 poles + ⊕	131
CMSH	3+2 (aux) poles + ⊕	136
CMCE	3+2 (aux) poles + ⊕	137
CSS	10 poles + ⊕	149
CT, CTSE (16A)	10 poles + ⊕	161
CQE	18 poles + ⊕	169
CX	8/24 poles + ⊕	194
MIXO	3 modules	262 - 317

hoods with 4 pegs



hoods with 4 pegs

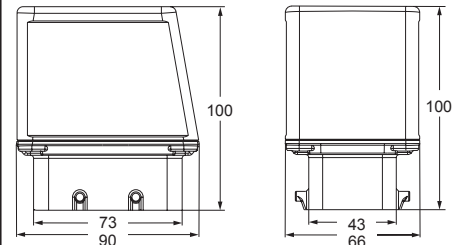
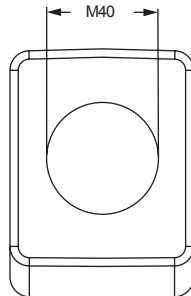
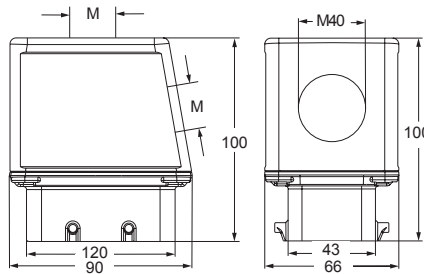
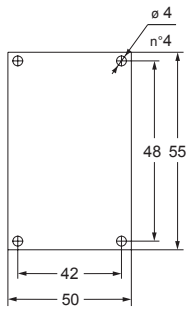
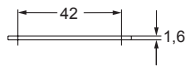


description	part No.	entry M	part No.
-------------	----------	---------	----------

with pegs, side and top entries **MBVO 10.240** 40 x 2

with pegs, without entries, designed to be drilled **CBC 10**

dimensions of electronic boards for CBC enclosures side entry



Housings (page 438)



CAUS® Type 4/4X/12

insulating cable gland or fittings without gasket

cable gland with O-Ring gasket

MB wider version BIG

inserts		page:
CD	40 poles + ⊕	70
CDD	72 poles + ⊕	79
CDS	27 poles + ⊕	-
CDSH	27 poles + ⊕	88
CNE	16 poles + ⊕	112
CSE	16 poles + ⊕	-
CSH	16 poles + ⊕	112
CSH S	16 poles + ⊕	124
CCE	16 poles + ⊕	132
CMSH, CMCE	6+2 (aux) poles + ⊕	138 - 139
CSS	16 poles + ⊕	150
CT, CTSE (16A)	16 poles + ⊕	162
CQE	32 poles + ⊕	170
CQEE	40 poles + ⊕	176
CP	6 poles + ⊕	178
CX	6/12, 6/36 and 12/2 poles + ⊕	197 - 199
CX	4/0 and 4/2 poles + ⊕	200 - 201
MIXO	4 modules	262 - 317

hoods with 4 pegs

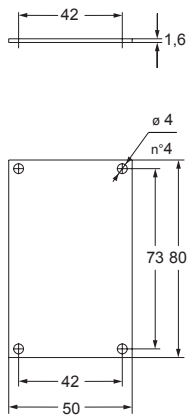


hoods with 4 pegs

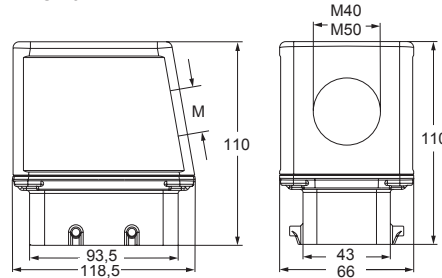


description	part No.	entry		part No.	entry	
			M			M
with pegs, side entry	MBO 16.40		40			
with pegs, side entry	MBO 16.50		50			
with pegs, top entry	MBV 16.40		40	MBV 16.232		32 x 2
with pegs, top entry	MBV 16.50		50	MBV 16.325		25 x 3

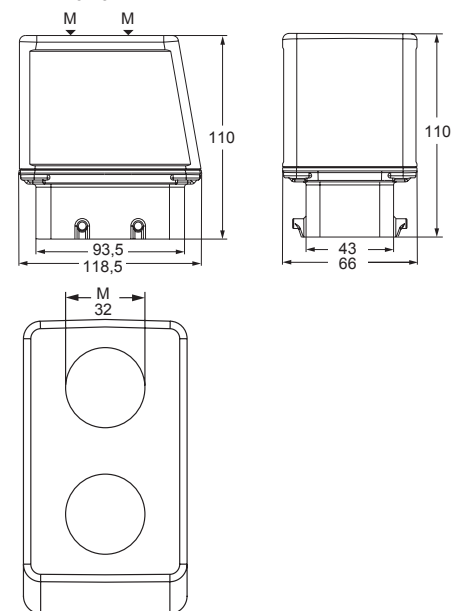
dimensions of electronic boards for MBO enclosures side entry



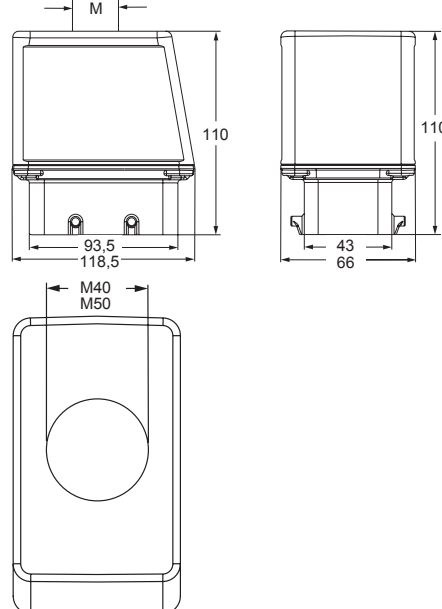
MBO 16



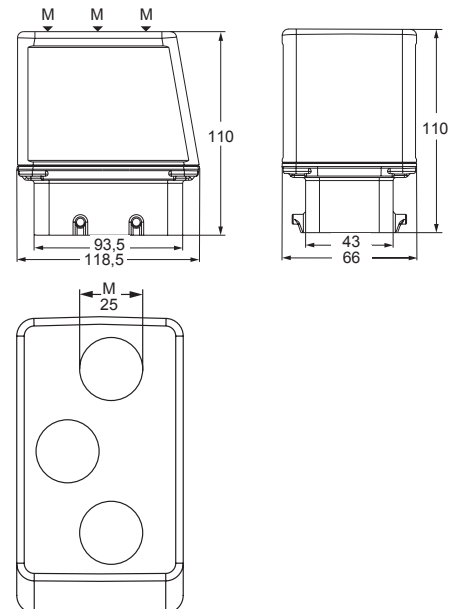
MBV 16.232



MBV 16




MBV 16.325




Housings
(page 439)



CAVUS Type
4/4X/12

 insulating cable gland or fittings
without gasket

 cable gland
with O-Ring gasket

CB and MB wider version BIG

inserts		page:
CD	40 poles + ⊕	70
CDD	72 poles + ⊕	79
CDS	27 poles + ⊕	-
CDSH	27 poles + ⊕	88
CNE	16 poles + ⊕	112
CSE	16 poles + ⊕	-
CSH	16 poles + ⊕	112
CSH S	16 poles + ⊕	124
CCE	16 poles + ⊕	132
CMSH, CMCE	6+2 (aux) poles + ⊕	138 - 139
CSS	16 poles + ⊕	150
CT, CTSE (16A)	16 poles + ⊕	162
CQE	32 poles + ⊕	170
CQEE	40 poles + ⊕	176
CP	6 poles + ⊕	178
CX	6/12, 6/36 and 12/2 poles + ⊕	197 - 199
CX	4/0 and 4/2 poles + ⊕	200 - 201
MIXO	4 modules	262 - 317

hoods with 4 pegs

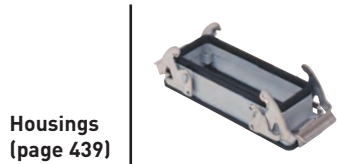
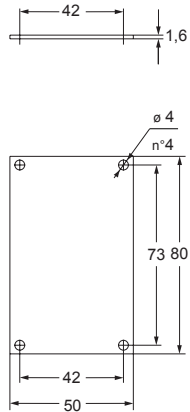


hoods with 4 pegs



description	part No.	entry		part No.	entry	
			M			M
with pegs, side entry	MBO 16.225	25	x 2			
with pegs, top entry	MBV 16.620	20	x 6			
with pegs, side and top entries				MBVO 16.240	40	x 2
with pegs, without entries, designed to be drilled				CBC 16	--	

dimensions of electronic boards for MBO and CBC enclosures side entry

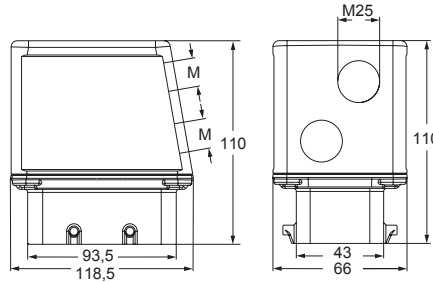


CAVUS Type 4/4X/12

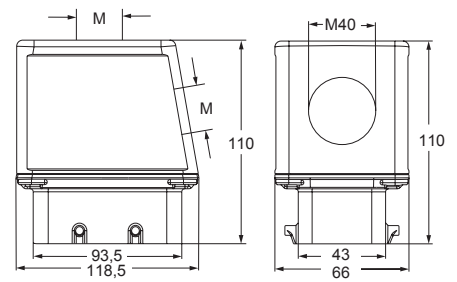
EN 60529 IP65 IEC 60529 insulating cable gland or fittings without gasket

EN 60529 IP66 IP67 IP69 IEC 60529 cable gland with O-Ring gasket

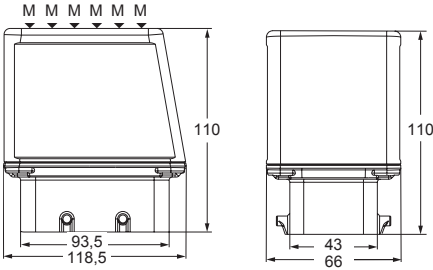
MBO 16.225



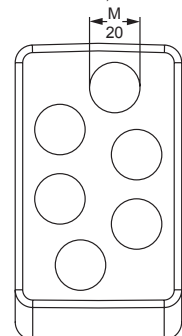
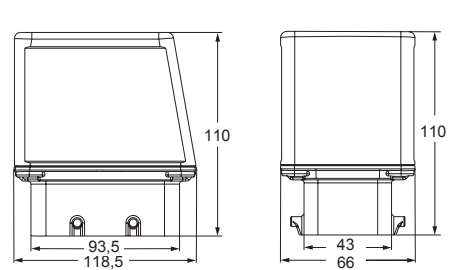
MBVO 16.240



MBV 16.620



CBC 16



MB wider version BIG

inserts

insert	poles	page
CD	64 poles + ⊕	72
CDD	108 poles + ⊕	81
CDS	42 poles + ⊕	-
CDSH	42 poles + ⊕	89
CNE	24 poles + ⊕	113
CSE	24 poles + ⊕	-
CSH	24 poles + ⊕	113
CSH S	24 poles + ⊕	125
CCE	24 poles + ⊕	133
CMSH	10+2 (aux) poles + ⊕	140
CMCE	10+2 (aux) poles + ⊕	141
CSS	24 poles + ⊕	151
CT, CTSE (16A)	24 poles + ⊕	163
CQE	46 poles + ⊕	171
CQEE	64 poles + ⊕	177
CX	4/8 and 6/6 poles + ⊕	204, 206
MIXO	6 modules	262 - 317

page:

hoods with 4 pegs

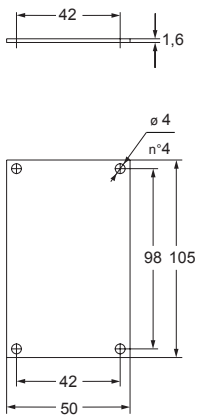


hoods with 4 pegs

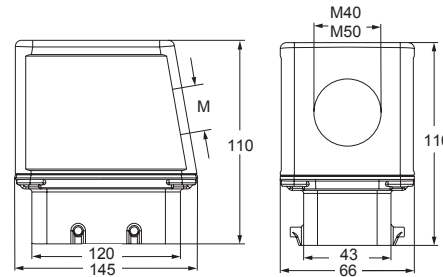


description	part No.	entry		part No.	entry	
			M			M
with pegs, side entry	MBO 24.40		40			
with pegs, side entry	MBO 24.50		50			
with pegs, top entry	MBV 24.40		40	MBV 24.240		40 x 2
with pegs, top entry	MBV 24.50		50	MBV 24.332		32 x 3

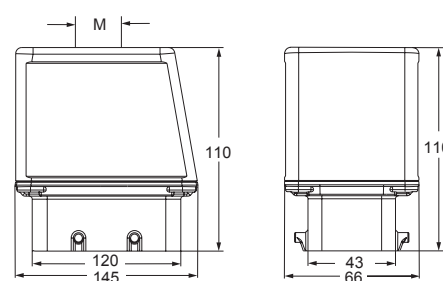
dimensions of electronic boards for MBO enclosures side entry



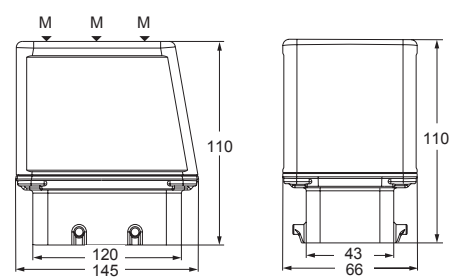
MBO 24



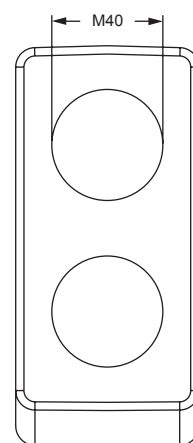
MBV 24



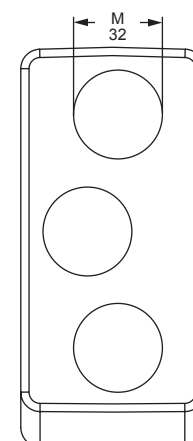
MBV 24.240 - MBV 24.332



MBV 24.240



MBV 24.332



Housings (page 441)



CALUS Type 4/4X/12

insulating cable gland or fittings without gasket

cable gland with O-Ring gasket

CB and MB wider version BIG

inserts		page:
CD	64 poles + ⊕	72
CDD	108 poles + ⊕	81
CDS	42 poles + ⊕	-
CDSH	42 poles + ⊕	89
CNE	24 poles + ⊕	113
CSE	24 poles + ⊕	-
CSH	24 poles + ⊕	113
CSH S	24 poles + ⊕	125
CCE	24 poles + ⊕	133
CMSH	10+2 (aux) poles + ⊕	140
CMCE	10+2 (aux) poles + ⊕	141
CSS	24 poles + ⊕	151
CT, CTSE (16A)	24 poles + ⊕	163
CQE	46 poles + ⊕	171
CQEE	64 poles + ⊕	177
CX	4/8 and 6/6 poles + ⊕	204, 206
MIXO	6 modules	262 - 317

hoods with 4 pegs

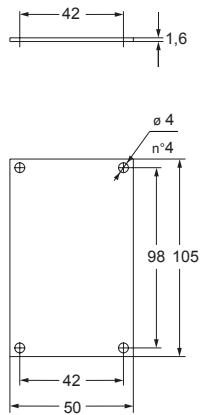


hoods with 4 pegs



description	part No.	entry M	part No.	entry M
with pegs, side entry	MBO 24.225	25 x 2		
with pegs, top entry	MBV 24.425	25 x 4		
with pegs, top entry	MBV 24.720	20 x 7		
with pegs, side and top entries			MBVO 24.250	50 x 2
with pegs, without entries, designed to be drilled			CBC 24	--

dimensions of electronic boards for MBO and CBC enclosures side entry



Housings (page 441)



CAVUS® Type 4/4X/12

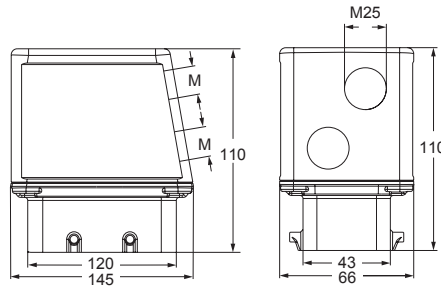


insulating cable gland or fittings without gasket

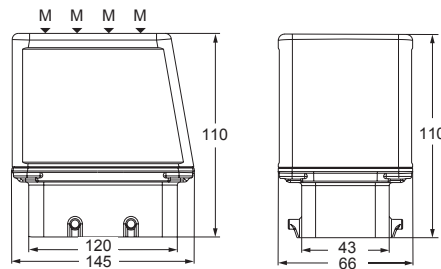


cable gland with O-Ring gasket

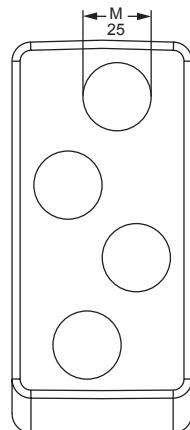
MBO 24



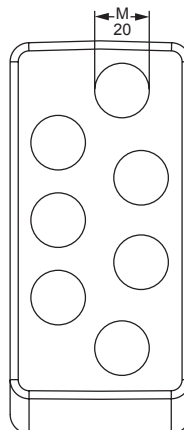
MBV 24.425 - MBV 24.270



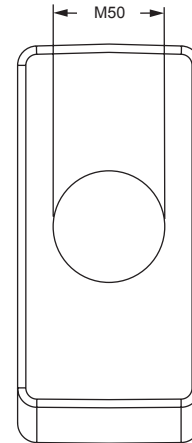
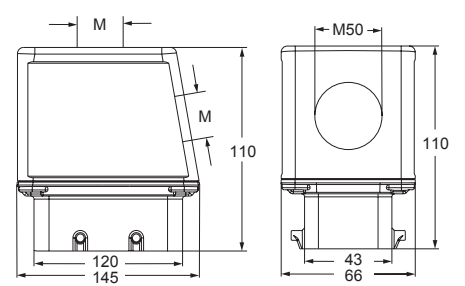
MBV 24.425



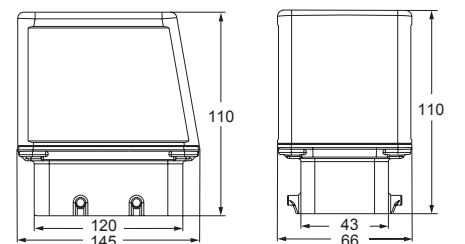
MBV 24.720



MBVO 24.250



CBC 24



T-TYPE enclosures

Standard & Aggressive environments,

Hygienic applications

**T-TYPE
STANDARD**
for standard
applications



Pages 478 - 487

T-TYPE/W
for aggressive
environments



Pages 488 - 492

**HYGIENIC
T-TYPE/H**
for food
& beverage

**HYGIENIC
T-TYPE/C**
for low
temperatures



Pages 493 - 509



ECOLAB®

T-TYPE general information

International standards

T-TYPE enclosures have been **successfully** tested in accordance with the following international standards, guaranteeing their usage for numerous applications:

- **EN 61984: Connectors - Safety requirements and tests.**
- **ANSI/UL 50 (Enclosures for Electrical Equipment)** equivalent to voluntary North American standard NEMA 250 (NEMA = National Electrical Manufacturers Association) and the corresponding Canadian standard CSA C22.2 No. 94 (Special Purpose Enclosures) for degrees of protection used in North America and required by local installation codes (e.g. NFPA 70 National Electrical Code in the USA, CSA plant standards for Canada). The current type approval was obtained after passing a series of tests carried out in accordance with the standard, in particular: **Type 12 (= NEMA 12)** for internal use, similar to degree of protection IP54 according to IEC/EN 60529. (Only standard T-TYPE enclosures).
- **EN 60529: Degrees of protection provided by enclosures (IP Code)** for ratings IP65, IP66 and IP69 (according to type).
- **EN 62262: Degrees of protection provided by enclosures for electrical equipment against external mechanical impacts (IK Code)** for ratings IK09 (enclosures with levers), IK10 (enclosures without levers).
- **IEC 60068-2-52: Environmental testing - Part 2-52: Salt mist, cyclic:** with 5% solution of sodium chloride (NaCl), solution Ph from 6,5 to 7,2;
ENVIRONMENTAL CONDITIONS: salt mist 35 °C for 2 hours; 40 °C for 168 hours with 93% relative humidity;
NO. OF CYCLES: 4;
TEST PASSED: maintaining the IP degree of protection and with a change of contact resistance $\leq 50\%$ of the initial value or $\leq 5 \text{ m}\Omega$.
- **IEC 60068-2-6: Environmental testing - Part 2-6: Vibration (sinusoidal):** with values 10Hz÷500Hz, 0,35 mm amplitude of displacement, 50m/s² (5g_n), crossover point 60,1 Hz;
NO. OF CYCLES: 10;
TEST PASSED: scanning 3 axes for 2 hours, with a change of contact resistance value $\leq 50\%$ of the initial value or $\leq 5 \text{ m}\Omega$ and no micro-interruption ($\geq 1 \mu\text{s}$).
- **IEC 60068-2-3: Environmental testing - Part 2-3: Damp heat, steady state:** at 40 °C, 93% relative humidity, 504 hours;
TEST PASSED: with a change of contact resistance value $\leq 50\%$ of the initial value or $\leq 5 \text{ m}\Omega$ and no disruptive discharge (insulation resistance $> 100 \text{ G}\Omega$).
- **IEC 60068-2-30: Environmental testing - Part 2-30: Damp heat, cyclic:** 40 °C, 95% relative humidity, 12 hours at ambient temperature;
NO. OF CYCLES: 21;
TEST PASSED: with a change of contact resistance value $\leq 50\%$ of the initial value or $\leq 5 \text{ m}\Omega$ and no disruptive discharge (insulation resistance $> 100 \text{ G}\Omega$).

T-TYPE general information

Resistance to chemicals comparison table

	T-TYPE	T-TYPE / W	T-TYPE / H	T-TYPE / C
A				
Acetone (propanone)	x	x	x	x
Active chlorine	x	x	x	x
Alum	●	●	●	●
Ammonia, 10% aqueous solution	●	x	●	●
Ammonia, liquid	x	x	●	●
Ammonium acetate	●	x	●	●
Ammonium carbonate	●	●	●	x
Ammonium chloride	●	●	●	x
Ammonium nitrate	●	●	●	●
Ammonium phosphate	●	●	●	●
Ammonium sulphate	●	●	●	●
Amyl alcohol	□	□	□	x
Aniline	□	□	x	x
Aqua regia (1:3 nitric acid : hydrochloric acid)	x	x	x	x
Asphalt	□	□	□	x

	T-TYPE	T-TYPE / W	T-TYPE / H	T-TYPE / C
B				
Beer	●	●	●	●
Benzene	x	□	x	x
Borax	□	□	□	□
Boric acid	●	●	●	●
Boric acid, 10% aqueous solution	●	●	●	●
Boric water (boric acid 3%)	●	●	●	●
Butane, gas	□	□	□	x
Butane, liquid	□	□	□	x

	T-TYPE	T-TYPE / W	T-TYPE / H	T-TYPE / C
C				
Calcium chloride	●	●	●	●
Calcium chloride, 10% aqueous solution	●	●	●	●
Calcium chloride, diluted suspension	●	●	●	●
Calcium nitrate	●	●	●	●
Calcium sulphate	●	●	x	●
Caustic potash (potassium hydroxide) 10%	x	●	●	x
Citric acid 50% aqueous solution	x	x	●	●
Copper sulphate 10% aqueous solution	●	●	●	●
Cresol	□	□	x	x
Cresolic solution	□	□	x	x
Cutting oil	□	□	□	x
Cyclo-hexane	□	□	□	x

	T-TYPE	T-TYPE / W	T-TYPE / H	T-TYPE / C
D				
Deca-hydro-naphtalene	x	x	x	x
Di-Ethylhexyl Phtalate	●	x	x	x
Di-isononyl Phtalate	●	x	x	x
Di-octyl Phtalate	●	●	x	x
Diesel Oil	□	□	□	□
Diluted Glucose	●	●	●	●

	T-TYPE	T-TYPE / W	T-TYPE / H	T-TYPE / C
D				
Diluted Glycerine	●	●	●	●
Diluted Glycol	●	●	●	●
Diluted Phenol	□	□	x	x
Diluted urea	●	●	●	●

	T-TYPE	T-TYPE / W	T-TYPE / H	T-TYPE / C
E				
Ethanol (ethyl alcohol)	x	x	●	●
Ethyl alcohol, 10% aqueous solution	●	●	●	●
Ethylene-glycol or propylene-glycol	●	●	●	●

	T-TYPE	T-TYPE / W	T-TYPE / H	T-TYPE / C
F				
Fatty acids	●	●	●	□
Ferric chloride, 10% aqueous solution	x	x	x	x
Formalin (formaldehyde 40% aqueous solution)	x	x	●	●
Fruit juices	●	●	●	●
Fuel oils	□	□	□	x

	T-TYPE	T-TYPE / W	T-TYPE / H	T-TYPE / C
G				
Gaseous ammonia	□	x	●	●
Gaseous propane	x	●	●	x
Glycerine	●	●	●	●
Grinding oil	□	□	□	x
Gypsum (see calcium sulphate)	●	●	x	●

	T-TYPE	T-TYPE / W	T-TYPE / H	T-TYPE / C
H				
Heptane	□	□	□	x
Hexane	□	□	□	x
Hydrochloric acid, <2% aqueous solution	x	x	●	□
Hydrogen sulphide	□	x	●	x

	T-TYPE	T-TYPE / W	T-TYPE / H	T-TYPE / C
I				
Ink	●	●	●	●
IRM oil 901	●	●	●	●
IRM oil 902	□	●	●	x
IRM oil 903	x	□	□	□
Isopropyl alcohol	□	●	●	●

	T-TYPE	T-TYPE / W	T-TYPE / H	T-TYPE / C
K				
Kitchen salt, aqueous solution	●	●	●	●

	T-TYPE	T-TYPE / W	T-TYPE / H	T-TYPE / C
L				
Lactic acid	●	●	●	●
Linseed oil	●	●	●	●
Liquid soap	x	●	●	●
Lubricating engine oil	□	□	□	x
Lubricating oil	●	●	●	x

The classification herewith provided is only a generic reference guide in order to enable a first selection. It is based on literature data provided by the suppliers of the raw materials used, which are related to tests carried out on specimens under test conditions which are not always homogeneous and involving accelerating techniques, therefore not necessarily describing real operational conditions. The actual behaviour of products in the field may therefore be positively or negatively influenced by

several variable environmental parameters such as temperature, relative humidity, simultaneous presence of a plurality of substances and their concentration, exposure time, dynamic or static application condition, and so on. The accuracy of transferring the indications given herein to the actual conditions of use is therefore merely indicative and does not imply any guarantee or responsibility by ILME.

Q NOTE: As the characterizing element of the T-TYPE/W series is the different sealing gasket material, hoods and covers without sealing gaskets for this series are the same of T-TYPE Standard.

	T-TYPE	T-TYPE / W	T-TYPE / H	T-TYPE / C
M				
Mercury	●	●	●	●
Methanol (methyl alcohol)	x	x	●	●
Methyl alcohol, diluted 50%	□	□	●	●
Mineral based oil	●	●	●	●
Mineral oils (un-tasteful)	●	●	●	●
Mothballs (naphthalene, paradichlorobenzene)	□	□	x	x
Muriatic acid, concentrated	x	x	x	x

N				
n-Butanol (butyl alcohol)	●	●	●	●
Naphthalene	□	●	x	x
Normal (low octane) gasoline (petrol)	□	□	□	x

O				
Octane	□	□	□	x
Oleic acid	●	●	●	x
Oxalic acid	●	●	●	●
Ozone	x	x	x	□

P				
Paraffin oil	●	●	●	●
Petrol ether	□	□	□	□
Petroleum	●	●	●	●
Petroleum spirit (dry cleaning)	□	□	x	x
Potassium carbonate	●	●	●	●
Potassium chlorate	●	●	x	●
Potassium chloride	●	●	●	●
Potassium cyanide, aqueous solution	●	●	●	●
Potassium di-chromate	□	□	●	●
Potassium iodide	□	□	●	●
Potassium nitrate	□	x	x	●
Potassium persulphate	□	□	x	●
Potassium sulphate	□	□	●	●

S				
Sea water	●	●	●	●
Silicon oil	●	●	●	x
Soap solution	□	●	●	●
Sodium bicarbonate (oxide)	●	●	●	●
Sodium carbonate (washing soda)	●	●	●	●
Sodium chlorate	●	●	x	●
Sodium chloride (kitchen salt)	●	●	●	●
Sodium bisulphate, aqueous solution	●	●	●	●
Sodium hydroxide (caustic soda)	x	x	●	●
Sodium hydroxide 12,5% (liscivia)	□	x	●	●
Sodium Hypochlorite	x	x	●	●

	T-TYPE	T-TYPE / W	T-TYPE / H	T-TYPE / C
S				
Sodium nitrate	●	●	●	x
Sodium nitrite	□	□	●	x
Sodium perborate	●	●	●	●
Sodium phosphate	●	●	●	x
Sodium silicate	●	x	x	●
Sodium sulphate	●	●	●	●
Sodium sulphide	●	●	●	●
Sodium Thiosulphate (photographic fixer)	●	●	●	●
Solution for photographic processing	●	●	●	●
Starch, aqueous (amylum)	●	●	●	●
Stearic acid	●	●	●	●
Succinic acid (butanedioic acid)	●	●	●	●
Sulphur	●	●	x	x
Sulphur dioxide (sulphurous anhydride)	□	x	x	□
Sulphuric acid, 2% aqueous solution	x	x	□	□

T				
Tallow	●	●	●	●
Tar	□	□	x	□
Tartaric acid	●	●	●	●
Toluene	x	x	x	x
Transformer oil (dielectric)	●	●	●	●
Trichloroethylene	x	x	x	x
Tricresyl phosphate	●	●	x	x
Turpentine essence	x	□	□	x

U				
Urine	●	●	●	●

V				
Vegetable oil	●	●	●	●
Vinegar	x	□	●	□

W				
Water	●	●	●	●
White alcohol (isopropanol + ethanol)	□	●	●	●

X				
Xylene	x	x	x	x

Legend

● : Resistant □ : Limited resistance x : Not resistant

T-TYPE standard

For modular and standard inserts

Alongside the wide range of traditional metallic enclosures for multipole connectors, ILME first "pioneered" a **series of enclosures in self-extinguishing thermoplastic material** in the most common sizes "44.27", "57.27", "77.27" and "104.27".

Quality and money saving are the main features of these enclosures, as an outcome of careful product studies.

Valuable characteristics of these versions of enclosures:

- **significant structural solidity** and mechanical robustness by virtue of **substantial thickness**;
- **external dimensions** of the bulkhead mounting housings are **similar to those of the corresponding metallic enclosures**; **hole fixing centres are unchanged**;

- **pre-fastened gaskets** for easier installation;
- **wide space inside the enclosures** for cables, with mounted connector inserts, similar to the corresponding "high construction" versions;
- possibility of making **total insulation** constructions (equivalent to Class II) ☐ ;
- **absence of powder paint** for environments in which these are not recommended (e.g. to avoid food contamination).

STANDARD APPLICATIONS

SUM-UP

- ☑ Enclosures in thermoplastic material, dark grey RAL 7012 colour, with high thicknesses providing structural solidity and durability
- ☑ Built-in polyurethane gaskets
- ☑ Locking levers in thermoplastic material colour grey RAL 7001
- ☑ M25, M32 and M40 threaded cable entries
- ☑ IP65 degree of protection according to EN 60529
- ☑ UL TYPE 12 degree of protection according to ANSI/UL50
- ☑ Each enclosure carries its own part number, thread/size, conformity markings and UL type rating
- ☑ Ambient temperature range: -40 °C / +90 °C



Interchangeability with other ILME series

T-TYPE series housings can be coupled with metal hoods.

Insulating hoods can be coupled with "V-TYPE" metal housings.

Hoods "57.27", "77.27" and "104.07" can be mounted on COB TCQ and COB BC frames simply by replacing the supplied levers with COB L levers (to be purchased separately).

Insulating enclosures are ideal for mounting of all ILME inserts with the exception of series models CT 40/ 64 and CTS 40/ 64 connector.

Inserts with 45° terminals of the CT series (screw-type terminals) and CTSE (spring terminals) are only insertable from the front (therefore not from the back) of the bulkhead mounting housings.

Being made by insulating material, they do not require a special reinforced insulation as metal ones do, for use with series CME higher voltage connector inserts (screw-type terminals).

With the exception of the limitations described below, it is generally possible to mount the MIXO series modular connectors and frames with the ground and screen anchors dedicated to this series.

Limitations

With respect to enclosures in metal alloy, ILME insulating enclosures have some limitations of use in combination with particular accessories:

- CRZ 06/ 10/ 16/ 24 reduction plates cannot be mounted with bulkhead mounting housings due to increased dimensions of the fastening flange of these insulating enclosures.
- The CYG 16 in-line joint cannot be mounted on the bulkhead mounting housings T-TYPE series because the gaskets of the latter do not fit together with the joint profile.
- The CYR 16.3 and CYR 24.4 round cable feed-throughs are difficult to position on their respective bulkhead mounting housings T-TYPE series.
- CPT 24 disposable protection cover cannot be mounted on insulating enclosures due to increased outer dimensions of these enclosures.
- MIXO series insert anchors cannot be mounted on TMAO 06/10 enclosures.
- CN insert anchors cannot be mounted on TMAO 06/10 enclosures.
- When using both cable entries of surface mounting housings, the conduit shall be of insulating type.

FOCUS ON:

1 Construction

By using the BC-MUL® moulding technique together with the use of MIL.BOX® material, **these enclosures are structurally solid and mechanically robust**, due to their increased thickness. They are particularly resistant to the main pollutants present in industrial environments. The lever enclosure pegs are built into the enclosures. The means for fastening the connector inserts to the enclosures consist of four M3 threaded metal inserts. Compared with metal construction enclosures, which – in order to comply with the electrical installation safety norms – must be earthed via a metal connection to the protective earth terminal of the inserts mounted inside the enclosures, this series of enclosures offers a solution for **total insulation constructions** ☐ (equivalent to class II) where necessary. The thermoplastic material used is RAL 7012 dark grey colour and **UL 94V-2** grade self-extinguishing and has passed the glow wire testing (GWEPT) in accordance with the EN IEC 60695-2-11 at **850 °C**, in excess of what required by the intended uses. The **surface mounting** high construction housings are supplied **with an open threaded entry** and diametrically opposite a closed threaded entry, which can be **opened** by the user, if required (with suitable tool). Manufactured from insulating material, they do not require **special reinforced insulation** as the metal versions do, for use with series **CME higher voltage** connector inserts (screw-type terminals), available only upon request.

2 Gaskets

T-TYPE standard sealing gaskets have been produced by means of the FIPFG technology (Formed-In-Place-Foam-Gasket). They have therefore been incorporated in the base flange on bulkhead mounting housings for easier installation.

☑ **T-TYPE standard: Built-in polyurethane gaskets**

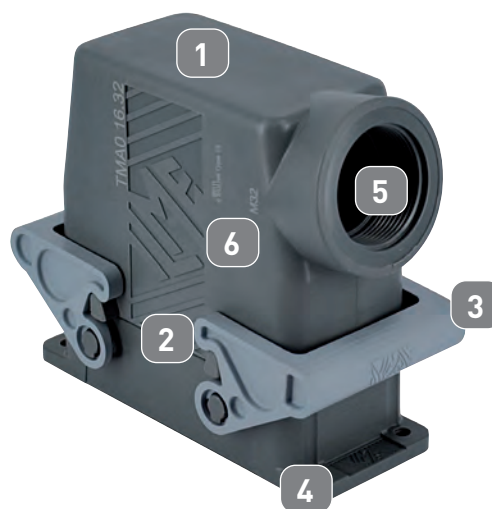
3 Levers

The locking levers have been produced in self-extinguishing thermoplastic material, grey RAL 7001 colour.

4 Dimensions

The internal dimensions allow mounting of all connector inserts in their relevant sizes. The external dimensions of the bulkhead mounting housings are similar to those of the corresponding metallic enclosures; hole fixing centres are unchanged.

Hoods offer an inner cabling space similar to that of the “high” construction models of the corresponding metal enclosures. Other characteristics are in compliance with the applicable safety standard for electrical connectors, IEC/EN 61984.



5 Cable entries

The housing and hood cable entries are available with metric thread, respectively:

Q M25 or M32 for smaller sizes “44.27” and “57.27”.

Q M32 or M40 for larger sizes “77.27” and “104.27”.

The recent standard IEC/EN 61076-7-100 regarding metric cable entries for multipole electrical connectors for heavy duty uses, which standardises some main dimensions for entries and their related accessories (gaskets, pressure nuts), have been carefully considered in the product design.

6 Markings

Each enclosure carries its own part number and conformity markings.

T-TYPE insulating STANDARD APPLICATIONS

inserts		page:
CDD	24 poles + ⊕	76
CDS	9 poles + ⊕	-
CDSH	9 poles + ⊕	86
CDSH NC	6 poles + ⊕	95
CNE	6 poles + ⊕	110
CSE	6 poles + ⊕	-
CSH	6 poles + ⊕	110
CSH S	6 poles + ⊕	122
CCE	6 poles + ⊕	130
CSS	6 poles + ⊕	148
CT, CTSE (16A) *)	6 poles + ⊕	160
CQE	10 poles + ⊕	168
MIXO	2 modules	262 - 317

*) only for standard insulating version TCHI

housings with single lever

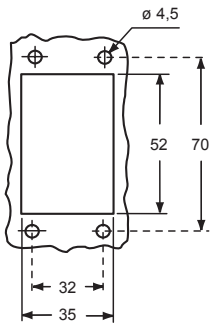


hoods with 2 pegs

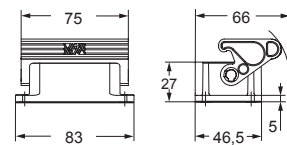


description	part No.	entry M	part No.	entry M
bulkhead mounting housing with thermoplastic lever	TCHI 06 L			
surface mounting housing with thermoplastic lever, high construction	TMAP 06 L25	25		
surface mounting housing with thermoplastic lever, high construction	TMAP 06 L32	32		
with pegs, side entry, high construction			TMAO 06 L25	25
with pegs, side entry, high construction			TMAO 06 L32	32
with pegs, top entry, high construction			TMAV 06 L25	25
with pegs, top entry, high construction			TMAV 06 L32	32

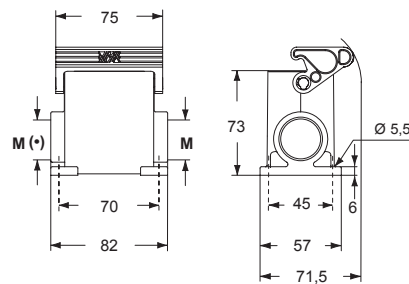
panel cut-out for bulkhead mounting housings



TCHI L

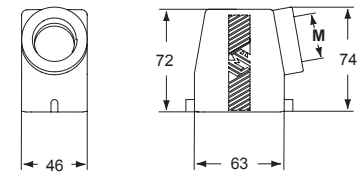


TMAP L

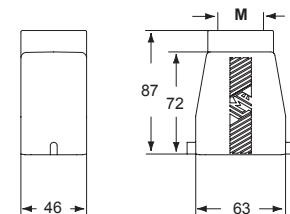


(*) The surface mounting, high construction housings are supplied with an open threaded entry (*) and diametrically opposite a closed threaded entry which can be opened by the user if required (with suitable tool).

TMAO L



TMAV L



CAIUS Type 12



ambient temperature limits -40 °C / +90 °C

T-TYPE insulating STANDARD APPLICATIONS

inserts		page:
CDD	24 poles + ⊕	76
CDS	9 poles + ⊕	-
CDSH	9 poles + ⊕	86
CDSH NC	6 poles + ⊕	95
CNE	6 poles + ⊕	110
CSE	6 poles + ⊕	-
CSH	6 poles + ⊕	110
CSH S	6 poles + ⊕	122
CCE	6 poles + ⊕	130
CSS	6 poles + ⊕	148
CT, CTSE (16A) *)	6 poles + ⊕	160
CQE	10 poles + ⊕	168
MIXO	2 modules	262 - 317

*) only for standard insulating version TCHI

hoods with single lever top entry

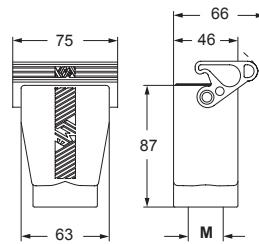


covers

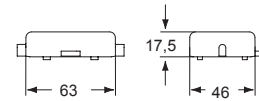


description	part No.	entry M	part No. (with eyelet)	part No. (with loop)
with thermoplastic lever and gasket, high construction	TMAV 06 LG25	25		
with thermoplastic lever and gasket, high construction	TMAV 06 LG32	32		
with pegs			TCHC 06 L	TCHC 06 SL
with thermoplastic lever and gasket				TCHC 06 LG

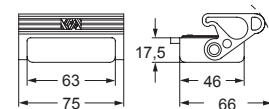
TMAV LG



TCHC L (SL)

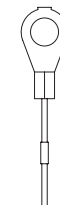


TCHC LG



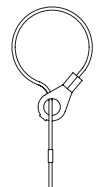
For fixing on housings

eyelet



For fixing on hoods

loop



CAIUS® Type 12



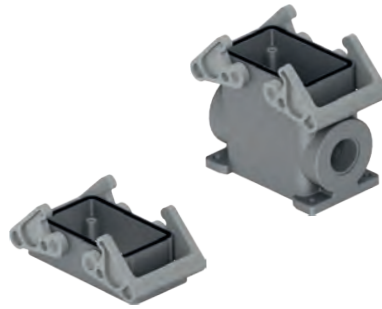
ambient temperature limits -40 °C / +90 °C

T-TYPE insulating STANDARD APPLICATIONS

inserts		page:
CDD	42 poles + ⊕	78
CDS	18 poles + ⊕	-
CDSH	18 poles + ⊕	87
CNE	10 poles + ⊕	111
CSE	10 poles + ⊕	-
CSH	10 poles + ⊕	111
CSH S	10 poles + ⊕	123
CCE	10 poles + ⊕	131
CMSH	3+2 (aux) poles + ⊕	136
CMCE	3+2 (aux) poles + ⊕	137
CSS	10 poles + ⊕	149
CT, CTSE (16A) *)	10 poles + ⊕	161
CQE	18 poles + ⊕	169
CX	8/24 poles + ⊕	194
MIXO	3 modules	262 - 317

*) only for standard insulating version TCHI

housings with double lever

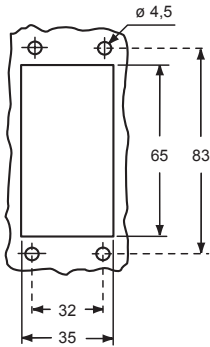


hoods with 4 pegs

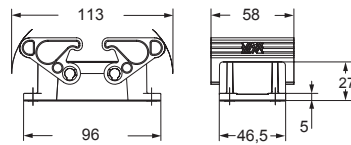


description	part No.	entry M	part No.	entry M
bulkhead mounting housing with thermoplastic levers	TCHI 10			
surface mounting housing, thermoplastic levers, high construction	TMAP 10.25	25		
surface mounting housing, thermoplastic levers, high construction	TMAP 10.32	32		
with pegs, side entry, high construction			TMAO 10.25	25
with pegs, side entry, high construction			TMAO 10.32	32
with pegs, top entry, high construction			TMAV 10.25	25
with pegs, top entry, high construction			TMAV 10.32	32

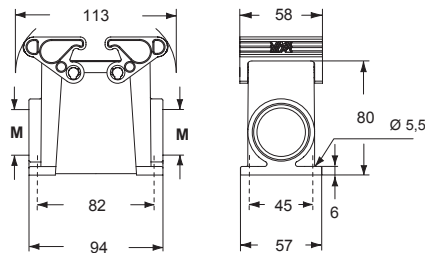
panel cut-out for bulkhead mounting housings



TCHI

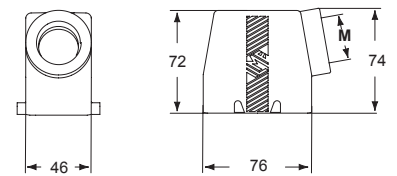


TMAP

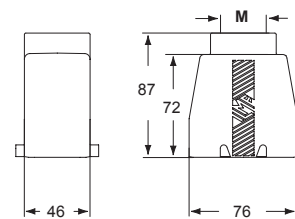


The surface mounting, high construction housings are supplied with an open threaded entry and diametrically opposite a closed threaded entry which can be opened by the user if required (with suitable tool).

TMAO



TMAV



CAIUS Type 12



ambient temperature limits -40 °C / +90 °C

T-TYPE STANDARD

T-TYPE insulating STANDARD APPLICATIONS

inserts		page:
CDD	42 poles + ⊕	78
CDS	18 poles + ⊕	-
CDSH	18 poles + ⊕	87
CNE	10 poles + ⊕	111
CSE	10 poles + ⊕	-
CSH	10 poles + ⊕	111
CSH S	10 poles + ⊕	123
CCE	10 poles + ⊕	131
CMSH	3+2 (aux) poles + ⊕	136
CMCE	3+2 (aux) poles + ⊕	137
CSS	10 poles + ⊕	149
CT, CTSE (16A) *)	10 poles + ⊕	161
CQE	18 poles + ⊕	169
CX	8/24 poles + ⊕	194
MIXO	3 modules	262 - 317

*) only for standard insulating version TCHI

hoods with double lever top entry

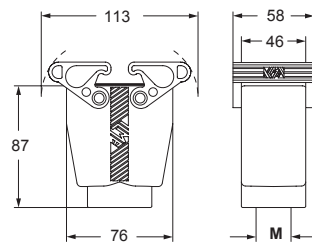


covers

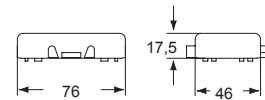


description	part No.	entry M	part No. (with eyelet)	part No. (with loop)
with thermoplastic levers and gasket, high construction	TMAV 10 G25	25		
with thermoplastic levers and gasket, high construction	TMAV 10 G32	32		
with 4 pegs			TCHC 10	TCHC 10 S
with 2 thermoplastic levers and gasket				TCHC 10 G

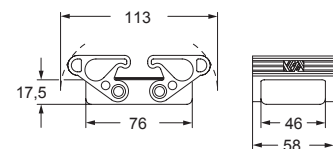
TMAV G



TCHC (S)

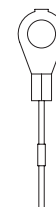


TCHC G



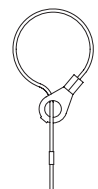
For fixing on housings

eyelet



For fixing on hoods

loop



CAIUS® Type 12



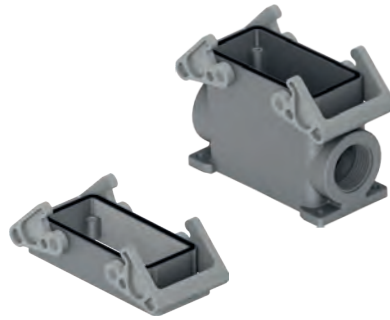
ambient temperature limits -40 °C / +90 °C

T-TYPE insulating STANDARD APPLICATIONS

inserts		page:
CD	40 poles + ⊕	70
CDD	72 poles + ⊕	79
CDS	27 poles + ⊕	-
CDSH	27 poles + ⊕	88
CNE	16 poles + ⊕	112
CSE	16 poles + ⊕	-
CSH	16 poles + ⊕	112
CSH S	16 poles + ⊕	124
CCE	16 poles + ⊕	132
CMSH, CMCE	6+2 (aux) poles + ⊕	138 - 139
CSS	16 poles + ⊕	150
CT, CTSE (16A) *)	16 poles + ⊕	162
CQE	32 poles + ⊕	170
CQEE	40 poles + ⊕	176
CP	6 poles + ⊕	178
CX	6/12, 6/36 and 12/2 poles + ⊕	197 - 199
CX	4/0 and 4/2 poles + ⊕	200 - 201
MIXO	4 modules	262 - 317

*) only for standard insulating version TCHI

housings with double lever

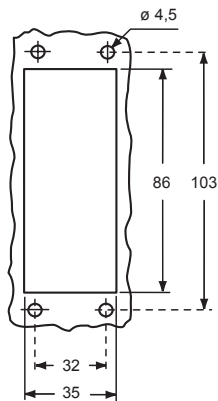


hoods with 4 pegs

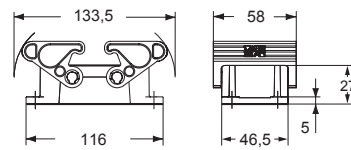


description	part No.	entry M	part No.	entry M
bulkhead mounting housing with thermoplastic levers	TCHI 16			
surface mounting housing, thermoplastic levers, high construction	TMAP 16.32	32		
surface mounting housing, thermoplastic levers, high construction	TMAP 16.40	40		
with pegs, side entry, high construction			TMAO 16.32	32
with pegs, side entry, high construction			TMAO 16.40	40
with pegs, top entry, high construction			TMAV 16.32	32
with pegs, top entry, high construction			TMAV 16.40	40

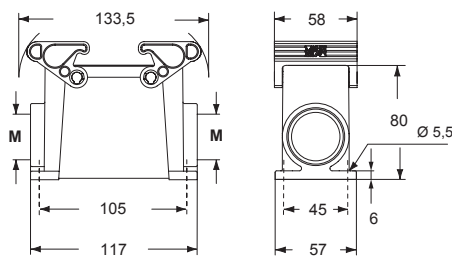
panel cut-out for bulkhead mounting housings



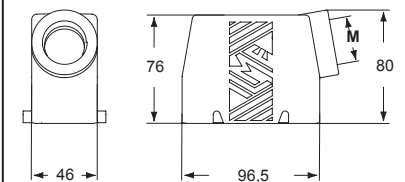
TCHI



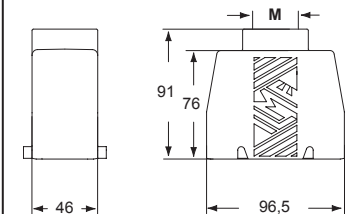
TMAP



TMAO

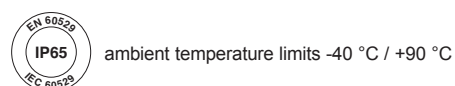


TMAV



The surface mounting, high construction housings are supplied with an open threaded entry and diametrically opposite a closed threaded entry which can be opened by the user if required (with suitable tool).

CAIUS® Type 12



T-TYPE STANDARD

T-TYPE insulating STANDARD APPLICATIONS

inserts		page:
CD	40 poles + ⊕	70
CDD	72 poles + ⊕	79
CDS	27 poles + ⊕	-
CDSH	27 poles + ⊕	88
CNE	16 poles + ⊕	112
CSE	16 poles + ⊕	-
CSH	16 poles + ⊕	112
CSH S	16 poles + ⊕	124
CCE	16 poles + ⊕	132
CMSH, CMCE	6+2 (aux) poles + ⊕	138 - 139
CSS	16 poles + ⊕	150
CT, CTSE (16A) *)	16 poles + ⊕	162
CQE	32 poles + ⊕	170
CQEE	40 poles + ⊕	176
CP	6 poles + ⊕	178
CX	6/12, 6/36 and 12/2 poles + ⊕	197 - 199
CX	4/0 and 4/2 poles + ⊕	200 - 201
MIXO	4 modules	262 - 317

*) only for standard insulating version TCHI

hoods with double lever top entry

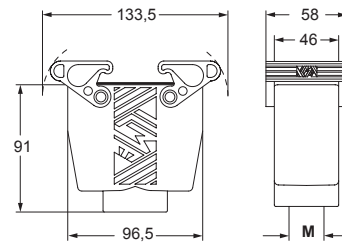


covers

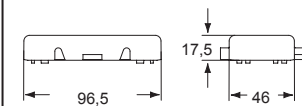


description	part No.	entry M	part No. (with eyelet)	part No. (with loop)
with thermoplastic levers and gasket, high construction	TMAV 16 G32	32		
with thermoplastic levers and gasket, high construction	TMAV 16 G40	40		
with 4 pegs			TCHC 16	TCHC 16 S
with 2 thermoplastic levers and gasket				TCHC 16 G

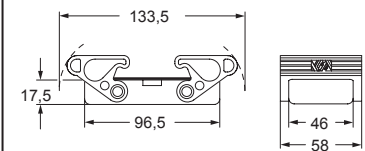
TMAV G



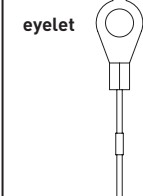
TCHC (S)



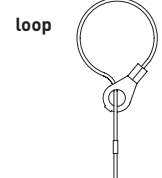
TCHC G



For fixing on housings



For fixing on hoods



CAIUS® Type 12

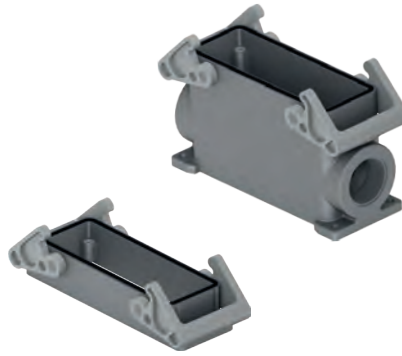
ambient temperature limits -40 °C / +90 °C

T-TYPE insulating STANDARD APPLICATIONS

inserts		page:
CD	64 poles + ⊕	72
CDD	108 poles + ⊕	81
CDS	42 poles + ⊕	-
CDSH	42 poles + ⊕	89
CNE	24 poles + ⊕	113
CSE	24 poles + ⊕	-
CSH	24 poles + ⊕	113
CSH S	24 poles + ⊕	125
CCE	24 poles + ⊕	133
CMSH	10+2 (aux) poles + ⊕	140
CMCE	10+2 (aux) poles + ⊕	141
CSS	24 poles + ⊕	151
CT, CTSE (16A) *)	24 poles + ⊕	163
CQE	46 poles + ⊕	171
CQEE	64 poles + ⊕	177
CX	4/8 and 6/6 poles + ⊕	204, 206
MIXO	6 modules	262 - 317

*) only for standard insulating version TCHI

housings with double lever

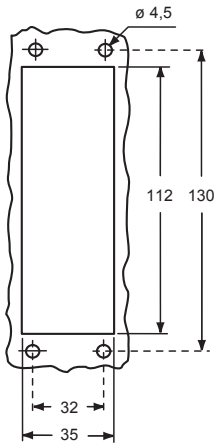


hoods with 4 pegs

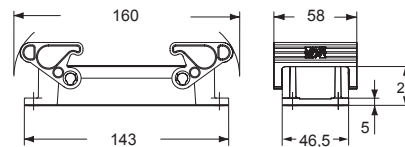


description	part No.	entry		part No.	entry	
		M			M	
bulkhead mounting housing with thermoplastic levers	TCHI 24					
surface mounting housing, thermoplastic levers, high construction	TMAP 24.32		32			
surface mounting housing, thermoplastic levers, high construction	TMAP 24.40		40			
with pegs, side entry, high construction				TMAO 24.32		32
with pegs, side entry, high construction				TMAO 24.40		40
with pegs, top entry, high construction				TMAV 24.32		32
with pegs, top entry, high construction				TMAV 24.40		40

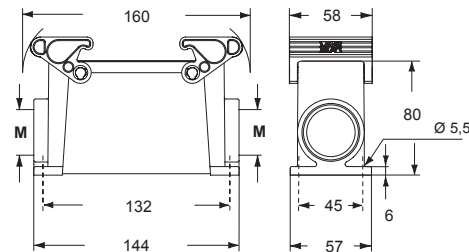
panel cut-out for bulkhead mounting housings



TCHI

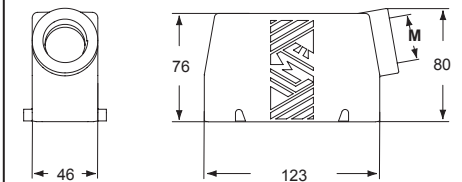


TMAP

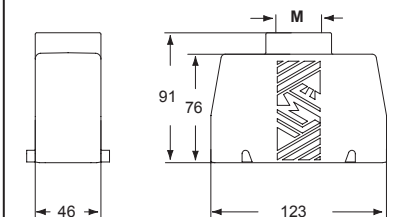


The surface mounting, high construction housings are supplied with an open threaded entry and diametrically opposite a closed threaded entry which can be opened by the user if required (with suitable tool).

TMAO



TMAV



CAIUS® Type 12



ambient temperature limits -40 °C / +90 °C

T-TYPE STANDARD

T-TYPE insulating STANDARD APPLICATIONS

inserts		page:
CD	64 poles + ⊕	72
CDD	108 poles + ⊕	81
CDS	42 poles + ⊕	-
CDSH	42 poles + ⊕	89
CNE	24 poles + ⊕	113
CSE	24 poles + ⊕	-
CSH	24 poles + ⊕	113
CSH S	24 poles + ⊕	125
CCE	24 poles + ⊕	133
CMSH	10+2 (aux) poles + ⊕	140
CMCE	10+2 (aux) poles + ⊕	141
CSS	24 poles + ⊕	151
CT, CTSE (16A) *)	24 poles + ⊕	163
CQE	46 poles + ⊕	171
CQEE	64 poles + ⊕	177
CX	4/8 and 6/6 poles + ⊕	204, 206
MIXO	6 modules	262 - 317

*) only for standard insulating version TCHI

hoods with double lever top entry

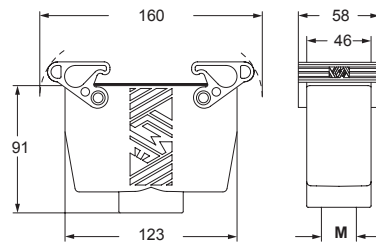


covers

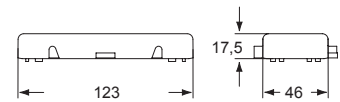


description	part No.	entry M	part No. (with eyelet)	part No. (with loop)
with thermoplastic levers and gasket, high construction	TMAV 24 G32	32		
with thermoplastic levers and gasket, high construction	TMAV 24 G40	40		
with 4 pegs			TCHC 24	TCHC 24 S
with 2 thermoplastic levers and gasket				TCHC 24 G

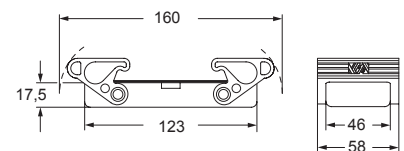
TMAV G



TCHC (S)



TCHC G



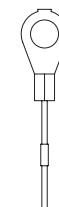
CRUS® Type 12



ambient temperature limits -40 °C / +90 °C

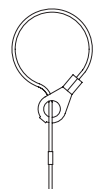
For fixing on housings

eyelet



For fixing on hoods

loop



T-TYPE/W

Aggressive environments

AGGRESSIVE ENVIRONMENTS

SUM-UP

- ☑ Enclosures in thermoplastic material, dark grey RAL 7012 colour, with high thicknesses providing structural solidity and durability
- ☑ Built-in FKM fluoroelastomer sealing gaskets
- ☑ Locking levers in thermoplastic material colour grey RAL 7001
- ☑ M25, M32 and M40 threaded cable entries
- ☑ IP66/IP69 degree of protection according to EN 60529
- ☑ UL TYPE 12 degree of protection according to ANSI/UL50
- ☑ Each enclosure carries its own part number, thread size and conformity markings and UL type rating
- ☑ Ambient temperature range: -40 °C / +90 °C

Q NOTE: As the characterizing element of the T-TYPE/W series is the different sealing gasket material, hoods and covers without sealing gaskets for this series are the same of T-TYPE Standard.

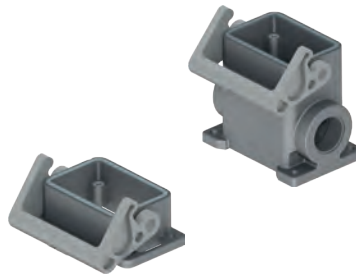


T-TYPE / W insulating AGGRESSIVE ENVIRONMENTS

inserts		page:
CDD	24 poles + ⊕	76
CDS	9 poles + ⊕	-
CDSH	9 poles + ⊕	86
CDSH NC	6 poles + ⊕	95
CNE	6 poles + ⊕	110
CSE	6 poles + ⊕	-
CSH	6 poles + ⊕	110
CSH S	6 poles + ⊕	122
CCE	6 poles + ⊕	130
CSS	6 poles + ⊕	148
CT, CTSE (16A) *)	6 poles + ⊕	160
CQE	10 poles + ⊕	168
MIXO	2 modules	262 - 317

*) only for standard insulating version THIW

housings with single lever FKM gasket

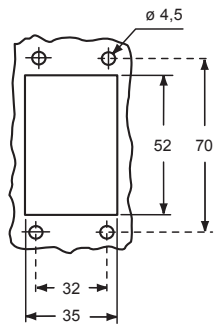


hoods with single lever, top entry covers, FKM gasket



description	part No.	entry M	part No.	entry M	part No. (with loop)
bulkhead mounting housing with thermoplastic lever	THIW 06 L				
surface mounting housing, thermoplastic lever, high construction	TAPW 06 L25	25			
surface mounting housing, thermoplastic lever, high construction	TAPW 06 L32	32			
with thermoplastic lever and gasket, high construction			TAVW 06 LG25	25	
with thermoplastic lever and gasket, high construction			TAVW 06 LG32	32	
cover with thermoplastic lever and gasket					THCW 06 LG

panel cut-out for bulkhead mounting housings

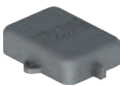


**TMAO
Hoods
(page 480)**

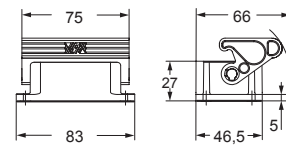


**TMAV
Hoods
(page 480)**

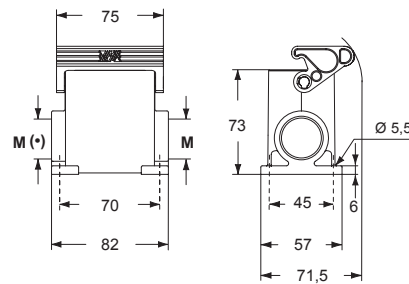
**TCHC L
TCHC SL
Covers
with eyelet
(page 481)**



THIW L

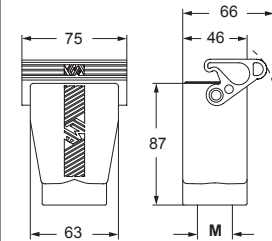


TAPW L

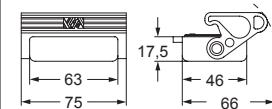


(*) The surface mounting, high construction housings are supplied with an open threaded entry (*) and diametrically opposite a closed threaded entry which can be opened by the user if required (with suitable tool).

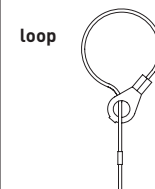
TAVW LG



THCW LG



For fixing on hoods



CAIUS Type 12



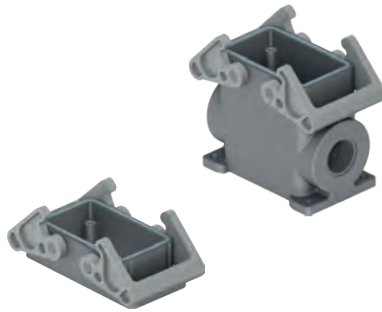
ambient temperature limits -40 °C / +90 °C

T-TYPE / W insulating AGGRESSIVE ENVIRONMENTS

inserts		page:
CDD	42 poles + ⊕	78
CDS	18 poles + ⊕	-
CDSH	18 poles + ⊕	87
CNE	10 poles + ⊕	111
CSE	10 poles + ⊕	-
CSH	10 poles + ⊕	111
CSH S	10 poles + ⊕	123
CCE	10 poles + ⊕	131
CMSH	3+2 (aux) poles + ⊕	136
CMCE	3+2 (aux) poles + ⊕	137
CSS	10 poles + ⊕	149
CT, CTSE (16A) *)	10 poles + ⊕	161
CQE	18 poles + ⊕	169
CX	8/24 poles + ⊕	194
MIXO	3 modules	262 - 317

*) only for standard insulating version THIW

housings with double lever FKM gasket

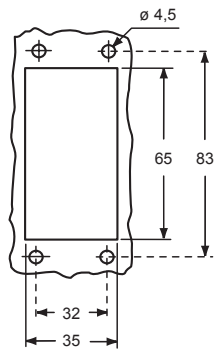


hoods with double lever, top entry covers, FKM gasket



description	part No.	entry M	part No.	entry M	part No. (with loop)
bulkhead mounting housing with thermoplastic levers	THIW 10				
surface mounting housing, thermoplastic levers, high construction	TAPW 10.25	25			
surface mounting housing, thermoplastic levers, high construction	TAPW 10.32	32			
with thermoplastic levers and gasket, high construction			TAVW 10 G25	25	
with thermoplastic levers and gasket, high construction			TAVW 10 G32	32	
cover with 2 thermoplastic levers and gasket					THCW 10 G

panel cut-out for bulkhead mounting housings



TMAO
Hoods
(page 482)

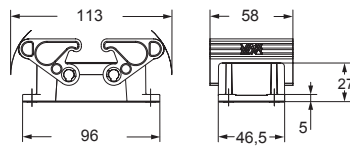


TMAV
Hoods
(page 482)

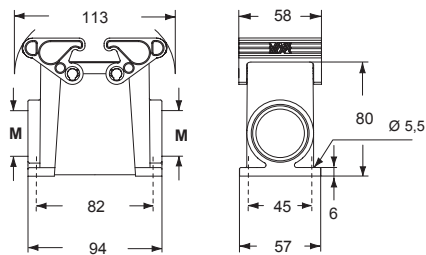
TCHC
TCHC S
Covers
with eyelet
(page 483)



THIW

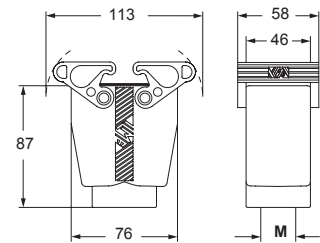


TAPW

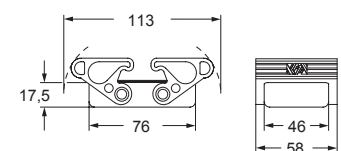


The surface mounting, high construction housings are supplied with an open threaded entry and diametrically opposite a closed threaded entry which can be opened by the user if required (with suitable tool).

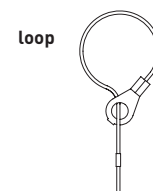
TAVW G



THCW G



For fixing on hoods



CAVUS® Type 12



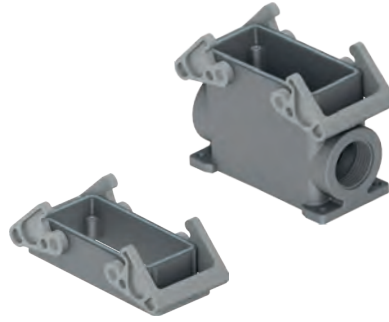
ambient temperature limits -40 °C / +90 °C

T-TYPE / W insulating AGGRESSIVE ENVIRONMENTS

inserts		page:
CD	40 poles + ⊕	70
CDD	72 poles + ⊕	79
CDS	27 poles + ⊕	-
CDSH	27 poles + ⊕	88
CNE	16 poles + ⊕	112
CSE	16 poles + ⊕	-
CSH	16 poles + ⊕	112
CSH S	16 poles + ⊕	124
CCE	16 poles + ⊕	132
CMSH, CMCE	6+2 (aux) poles + ⊕	138 - 139
CSS	16 poles + ⊕	150
CT, CTSE (16A) *)	16 poles + ⊕	162
CQE	32 poles + ⊕	170
CQEE	40 poles + ⊕	176
CP	6 poles + ⊕	178
CX	6/12, 6/36 and 12/2 poles + ⊕	197 - 199
CX	4/0 and 4/2 poles + ⊕	200 - 201
MIXO	4 modules	262 - 317

*) only for standard insulating version THIW

housings with double lever FKM gasket

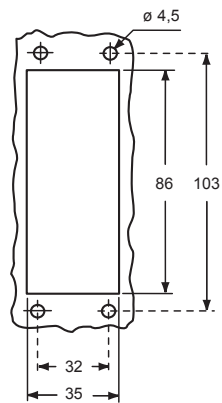


hoods with double lever, top entry covers, FKM gasket



description	part No.	entry M	part No.	entry M	part No. (with loop)
bulkhead mounting housing with thermoplastic levers	THIW 16				
surface mounting housing, thermoplastic levers, high construction	TAPW 16.32	32			
surface mounting housing, thermoplastic levers, high construction with thermoplastic levers and gasket, high construction	TAPW 16.40	40			
with thermoplastic levers and gasket, high construction			TAVW 16 G32	32	
with thermoplastic levers and gasket, high construction cover with 2 thermoplastic levers and gasket			TAVW 16 G40	40	
					THCW 16 G

panel cut-out for bulkhead mounting housings



TMAO Hoods
(page 484)

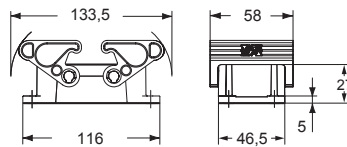


TMAV Hoods
(page 484)

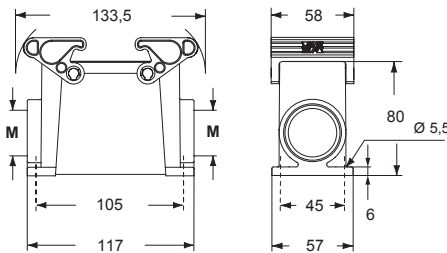
TCHC TCHC S Covers with eyelet
(page 485)



THIW

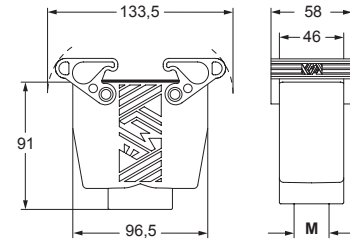


TAPW

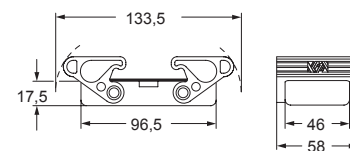


The surface mounting, high construction housings are supplied with an open threaded entry and diametrically opposite a closed threaded entry which can be opened by the user if required (with suitable tool).

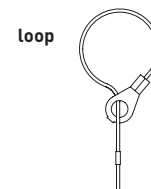
TAVW G



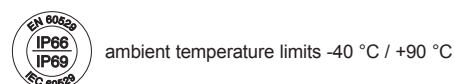
THCW G



For fixing on hoods



CAIUS Type 12

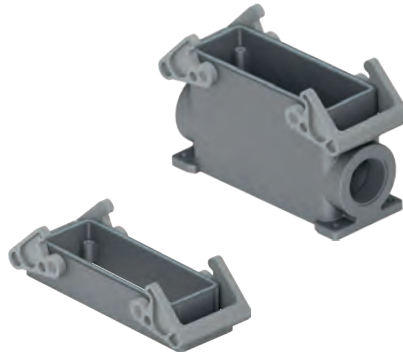


T-TYPE / W insulating AGGRESSIVE ENVIRONMENTS

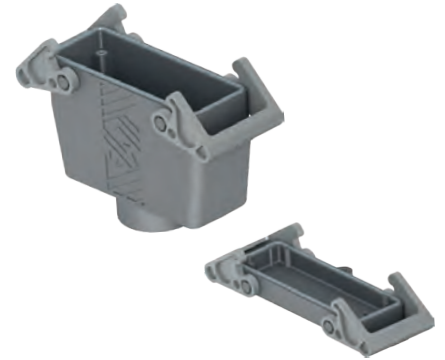
inserts		page:
CD	64 poles + ⊕	72
CDD	108 poles + ⊕	81
CDS	42 poles + ⊕	-
CDSH	42 poles + ⊕	89
CNE	24 poles + ⊕	113
CSE	24 poles + ⊕	-
CSH	24 poles + ⊕	113
CSH S	24 poles + ⊕	125
CCE	24 poles + ⊕	133
CMSH	10+2 (aux) poles + ⊕	140
CMCE	10+2 (aux) poles + ⊕	141
CSS	24 poles + ⊕	151
CT, CTSE (16A) *	24 poles + ⊕	163
CQE	46 poles + ⊕	171
CQEE	64 poles + ⊕	177
CX	4/8 and 6/6 poles + ⊕	204, 206
MIXO	6 modules	262 - 317

*) only for standard insulating version THIW

housings with double lever FKM gasket

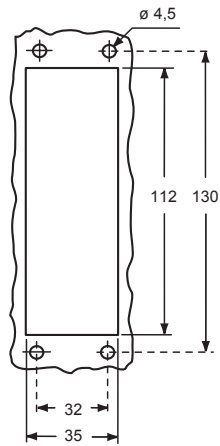


hoods with double lever, top entry covers, FKM gasket



description	part No.	entry M	part No.	entry M	part No. (with loop)
bulkhead mounting housing with thermoplastic levers	THIW 24				
surface mounting housing, thermoplastic levers, high construction	TAPW 24.32	32			
surface mounting housing, thermoplastic levers, high construction	TAPW 24.40	40			
with thermoplastic levers and gasket, high construction			TAVW 24 G32	32	
with thermoplastic levers and gasket, high construction			TAVW 24 G40	40	
cover with 2 thermoplastic levers and gasket					THCW 24 G

panel cut-out for bulkhead mounting housings



TMAO
Hoods
(page 486)



TMAV
Hoods
(page 486)

TCHC
TCHC S
Covers
with eyelet
(page 487)

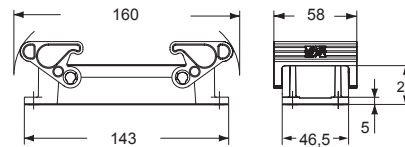


CAIUS® Type 12

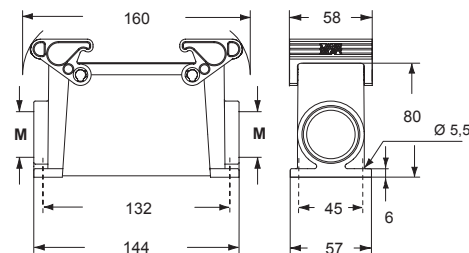


ambient temperature limits -40 °C / +90 °C

THIW

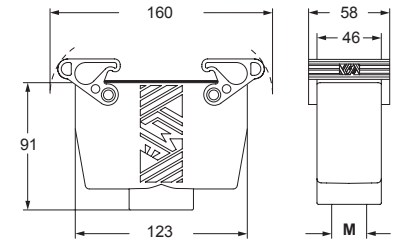


TAPW

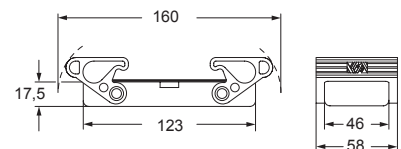


The surface mounting, high construction housings are supplied with an open threaded entry and diametrically opposite a closed threaded entry which can be opened by the user if required (with suitable tool).

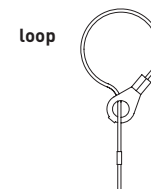
TAVW G



THCW G



For fixing on hoods



T-TYPE HYGIENIC

Resistance of materials to detergents/disinfectants used in the food industry



ILME T-TYPE/H and T-TYPE/C enclosure materials have been selected to guarantee compatibility with the principal alkaline or acid detergents and disinfectants used in the food industry. In particular, series T-TYPE/H

and T-TYPE/C enclosures have been tested according to protocol **F&E/ P3-E n. 40-1** by **Ecolab**, leading multinational in the detergent sector, to verify their compatibility with the following cleaning fluids:

- | | |
|--|--|
| <ul style="list-style-type: none"> ● Acid foaming detergents: P3-topax 52, Topaz AC5, P3-topmaxx 520 and P3-topax 56. ● Alkaline foaming detergents: P3-topax 19, Topaz MD3 and Ecofoam Basic. ● Strong alkaline foaming detergents: P3-topax 36, Topaz HD1 and P3-topax 30. | <ul style="list-style-type: none"> ● Alkaline-chloride foaming detergents-disinfectants: P3-topax 66, Ecofoam CL and P3-topax M95. ● Non-foaming peracetic based disinfectants: P3-oxonia active, P3-topactive OKT0 and P3-topactive DES. ● Neutral disinfectants: P3-topax 990 and P3-topax 91. |
|--|--|
-
- Full immersion of parts in detergent/disinfectant solutions.
 - Water hardness of 200ppm CaCO₃
 - Tests performed at concentrations 30% higher than those normally recommended in technical data sheets.
 - Test duration (each detergent): 28 days at 20 °C (equivalent to 6 years of daily cleaning).
 - Test solution renewed every 3-4 days for oxidizing products (P3-oxonia active, P3-topactive OKT0, P3-topax 66).
 - Test results evaluation: ISO 4068-1 (esthetic appearance and mass loss).

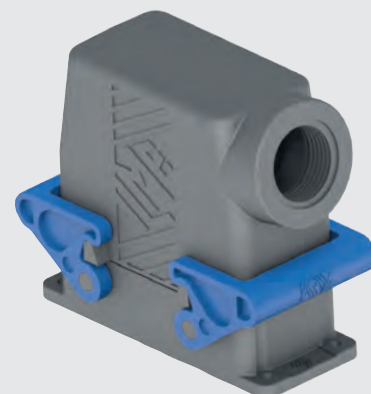
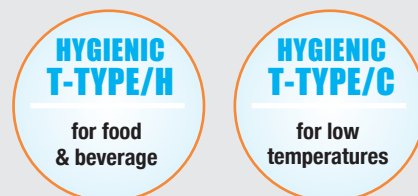
Cleanability and degrees of protection used in the food industry

ECOLAB F&E/P3-E n. 40-1 Test Protocol see declaration of compatibility at pages 494-495

Series T-TYPE/H and T-TYPE/C enclosures have been designed to facilitate cleaning of surfaces that could potentially come into contact with food. For this purpose **Series T-TYPE/H and T-TYPE/C** enclosures have **IP66 and IP69 degrees of protection as per IEC 60529 Edition 2.2 (2013-08)** to allow jet washing, as typically used in the food industry.

The suitability of ILME products for the **cleanability** requirements stated by Machinery Directive 2006/42/EC for both Splash and Food Area zones (EN 1672-2 and EN ISO 14159) **depends on the specific installation of ILME products on the machine and must be evaluated by the machine manufacturer.**

In addition to the Hygienic version, aluminium enclosures are also available with degrees of protection up to IP68 (check for possible applicability).



Declaration of compatibility - By courtesy of ECOLAB s.r.l.



DECLARATION OF COMPATIBILITY
between ECOLAB hygiene products
and ILME enclosures for multiple connectors

For the completely safe cleaning of your plant



The ideal partner for Industrial Connections for power supply of plug connected devices, connections for auxiliary circuits and automation control:

T-type H and T-type C enclosures



The declaration proves the high resistance of these enclosures to Ecolab products commonly and worldwide used in Food and Beverage Industries.

ILME S.p.a.
Via Marco Antonio Colonna, 9 - 20149 Milano (MI)
www.ilme.com



Supplier of hygiene solutions for Food and Beverage industries

Products



Equipments



Services



Ecolab s.r.l.
Via Paracelso 6 - 20864 Agrate Brianza (MB)
www.it.ecolab.eu

T-TYPE HYGIENIC



Compatible products with T-type/C and T-type/H ILME enclosures

See below for the test procedure

PRODUCT	%	T-TYPE ENCLOSURE	DEFECT QUANTITY	DEFECT QUALITY	COLOR VARIATION
P3-topax 52 - Topaz AC5	6	C and H	0	0	0
P3-topax 19 - Topaz MD3	6	C and H	0	0	0
P3-topax 36 - Topaz HD1	6	C and H	0	0	0
P3-topax 91	6	C and H	0	0	0
P3-topax 990	6	C and H	0	0	0
P3-oxonia active	1	C and H	0	0	0
P3-topactive okto	3	C and H	0	0	0
P3-topax 66	6	C and H	0	0	0

DEFECT QUANTITY: 0 means - No detectable defect
 DEFECT QUALITY: 0 means - Up to 10x magnification no detectable defect
 COLOR VARIATION: 0 means - Unchanged, no discoloration

Test procedure

- Test performed by Ecolab Technical Application Service
- Ecolab reference method 40.1 – ISO 4068-1 for the evaluation
- Full immersion of parts in detergent/disinfectant solutions
- Water hardness of 200ppm CaCO₃
- 28 days total time at 20°C (equivalent to the contact time that occurs in 6 years of daily cleaning)
- Concentrations tested 30% higher than those normally recommended
- Test solution renewed every 3-4 days for oxidizing products (P3-oxonia active, P3-topactive OKTO, P3-topax 66)

Final statement

- The Ecolab Technical Application Service Italy certifies that the ILME enclosures for multipole connectors T-type/C and T-type/H are perfectly compatible with the above listed Ecolab detergents and disinfectants used in a concentration 30% higher than those normally recommended.

February 2016

HYGIENIC

Requirements on materials in contact or that may come into contact with food products

T-TYPE/H and T-TYPE/C materials have been selected to satisfy the requirements of EHEDG Guideline n° 32 "Materials of construction for food equipment in contact with food" and point 2.1.1, letter a) in Annex I of the Machinery Directive 2006/42/EC. Paragraph 91 of the Guide to the application of Machinery Directive 2006/42/EC specifies that the reference at Annex I, point 2.1.1, letter a) of the directive must be considered as a reference to EC regulation n. 1935/2004 and directive 2002/72/EC.

EU commission regulation n. 10/2011 dated 14 January 2011, concerning plastic material and objects designed for contact with food products, is a specific measure as provided for by article 5, paragraph 1 of the above-mentioned EC regulation n. 1935/2004.

It defines specific regulations for plastic materials and objects in order to guarantee their use in safe conditions and supersedes commission directive 2002/72/EC dated 6 August 2002 on plastic materials and objects designed for contact with food products. Art. 2, section 2 of the above-mentioned EU regulation n. 10/2011 specifies that rubber and silicone do not fall within the field of application of the regulation. EU regulation n. 10/2011 provides for the use of materials in positive lists of technological monomers, additives and adjuvants and the passing of global and specific migration tests in food simulants.

ILME T-TYPE/H and T-TYPE/C series enclosure materials have been selected according to EU n. 10/2011 regulation requirements and each component has been tested according to EU regulation n. 10/2011 and EC regulation n. 1935/2004.

Furthermore, T-TYPE/H and T-TYPE/C series gasket materials have been formulated according to FDA Guideline 21 CFR §177.2600 and T-TYPE enclosures and levers materials complying with FDA, 21 CFR, §177.1520 (a)(3)(i)(c)(1), (b) and (c)3.1a.



HYGIENIC

Risk Assessment and Critical Control Points in the food industry

Companies that work in the food sector must implement HACCP, i.e. Hazard Analysis and Critical Control Points system (EC Regulation 852/2004 on food product hygiene in force since 01/01/2006) and can voluntarily apply for various certificates (ISO 22000, BRC, ISF, etc.).

All those involved in primary food production (harvesting, milking, breeding), its preparation, transformation, manufacturing, packaging, storage, transport, distribution, handling, sales or supply, including consumer catering, are required to implement an HACCP system, i.e. a series of procedures aimed at preventing food contamination hazards. HACCP is based on monitoring food processing points where biological, chemical or physical contamination hazards may arise. In 2006, HACCP was made mandatory for companies that deal with the food for animals (production of raw materials, mixtures and additives).

A company required to implement HACCP can initially divide its food processing machinery into three zones from the point of view of risk for food product hygiene. The choice of the zone in which the wiring and connectors are installed depends on the risk assessment the manufacturer must conduct as per Machinery Directive 2006/42/EC which, in chapter 2.1, sets out the additional requirements for the food industry (see Table 1).

Table 1. According to EN 1672-2:2009 - Food processing machinery - Basic concepts - Part 2: Hygiene requirements

Application Zones	Zone Requirements	Usable Products
No Food Area: Zone where there is <u>no contact risk</u> with food.	<u>No additional requirement</u> for the food industry.	Enclosures series T-TYPE, T-TYPE/W, C-TYPE, BIG, IP68, C7 IP67, W-TYPE, EMC, COB, ...
Splash Area: Zone where <u>components may come into contact with food</u> but <u>there is no risk</u> that the food that came into contact with the components in this area <u>returns to the production cycle</u> .	In this zone, <u>components</u> also come into contact with cleaning agents used in the food industry and <u>must therefore be cleanable and resistant to the washing process</u> (see "Resistance of materials to detergents/disinfectants used in the food industry" and "Cleanability and degrees of protection used in the food industry").	<u>Hygienic</u> version enclosures series <u>T-TYPE/H and T-TYPE/C</u> .
Food Area: Zone where <u>components may come into contact with food</u> , with the risk that the food that came into contact with the components in this area <u>returns to the production cycle</u> .	In this zone, in addition to complying with the cleanability and washing requirements, the <u>components</u> are also subject to a series of more <u>stringent requirements</u> aimed at making negligible the <u>risk of food contamination</u> in the process (see paragraph "Requirements on materials in contact or that may come into contact with food products").	For more information about T-TYPE/C in special version, please contact our Offices.

HYGIENIC

T-TYPE/H & T-TYPE/C

The evolution of T-TYPE insulating enclosures meets food and beverage requirements



The Hygienic multi-pole connector enclosures version (series T-TYPE/H and T-TYPE/C) has been designed for installation on food industry machines and systems.

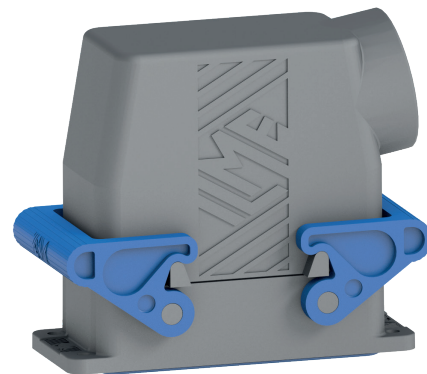
For this purpose, the following improvements to the T-TYPE series have been made in order to satisfy the requirements laid down by chapter 2.1 of Machinery Directive 2006/42/EC for the machines on which they are installed:

- material cleanability and resistance to the cleaning and sanitising agents normally used in the food industry;
- materials in terms of the requirements for accidental contact with food products.

The T-TYPE/H and T-TYPE/C series enclosures fit different sealing gaskets.

For T-Type/H series enclosures, the sealing gasket is in HNBR rubber, a material with excellent resistance to both acidic and alkaline detergents as well as any animal and vegetable fats it could come into contact with in food industry applications.

For T-TYPE/C series enclosures, the sealing gasket is made by silicone rubber, a material with good resistance to acidic and alkaline detergents as well as animal and vegetable fats. It is also characterised by its improved resistance to low temperatures (series suitable for uses as low as -50 °C), conditions that can arise in food industries that use the cold chain.



A dedicated variant of this new Hygienic version may be used where a high risk of accidental contact with food is occurring during production (see Table 1, Application Zones, Food Area). For more information about this possible special version, please contact our Offices.

In accordance with the requirements set forth in EHEDG Guideline n. 32 "Materials of construction for food equipment in contact with food" (EHEDG = European Hygienic Engineering & Design Group), the closing levers and sealing gaskets are coloured blue to easily identify any accidental contaminations in food products and to facilitate the visual identification of their complete cleanliness.

For this purpose, the following improvements to the T-TYPE series have been made in order to satisfy the requirements laid down by chapter 2.1 of **Machinery Directive 2006/42/EC** for the machines on which they are installed:

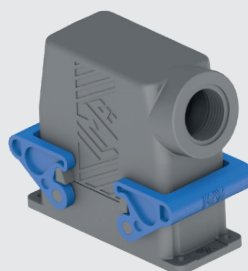
- material cleanability and resistance to the cleaning and sanitising agents normally used in the food industry;

- materials in terms of the requirements for accidental contact with food products.

T-TYPE/H - PRODUCTION LINES APPLICATIONS

SUM-UP

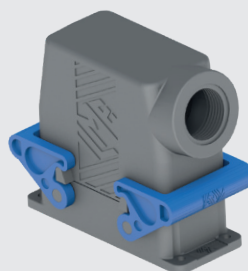
- ☑ Enclosures in thermoplastic material, dark grey RAL 7012 colour, with high thicknesses providing structural solidity and durability
- ☑ Sealing gaskets made by HNBR rubber formulated in accordance with FDA Guideline 21 CFR §177.2600
- ☑ Locking levers in metal detectable thermoplastic material, blue colour
- ☑ M25, M32 and M40 threaded cable entries
- ☑ IP66 and IP69 degree of protection according to EN 60529
- ☑ Each enclosure carries its own part number, thread/size and conformity markings
- ☑ Ambient temperature range: -40 °C / +70 °C



T-TYPE/C - LOW TEMPERATURE APPLICATIONS

SUM-UP

- ☑ Enclosures in thermoplastic material, dark grey RAL 7012
- ☑ The Hygienic T-TYPE/C Series enclosures have been specifically designed for food and beverage ambient temperature as low as -50 °C (range: -50 °C / +70 °C)
- ☑ Enclosures in thermoplastic material, dark grey RAL 7012 colour, with high thicknesses providing structural solidity and durability
- ☑ IP66 and IP69 degree of protection according to EN 60529
- ☑ This version differs from the Hygienic T-TYPE/H one for the sealing gaskets made by in accordance with FDA Guideline 21 CFR §177.2600
- ☑ ILME T-TYPE/C series enclosure materials have been selected according to EU n. 10/2011 regulation requirements and each component has been tested according to EU regulation n. 10/2011 and EC regulation n. 1935/2004



NOTE: As the characterizing elements of the Hygienic Series are the different sealing gasket material and the different locking lever, hoods and covers without sealing gaskets and locking levers are the same of series T-TYPE Standard.

HYGIENIC

T-TYPE/H & T-TYPE/C

FOCUS ON:

1 Construction

By using the BC-MUL® moulding technique together with the use of MIL.BOX® material, **these enclosures are structurally solid and mechanically robust**, due to their increased thickness.

They are particularly resistant to the main pollutants present in industrial environments. The enclosure pegs are built into the enclosures.

The means for fastening the connectors to the enclosures consist of four M3 threaded metal inserts. Compared with metal construction enclosures, which – in order to comply with electrical installation safety norms– must be earthed via a metal connection to the protective earth terminal of the connector insert inside the enclosure, this series of enclosures offers a solution for **total insulation constructions** ☐ (equivalent to class II) where necessary.

The thermoplastic material used is RAL 7012 dark grey colour and has passed **glow wire** testing (GWEPT) in accordance with the EN IEC 60695-2-11 at **850 °C**, in excess of what required by the intended uses.

The surface mounting, high construction housings are supplied with an open threaded entry and diametrically opposite a closed threaded entry which can be opened by the user if required (with suitable tool).

2 Gaskets

Gaskets have been produced in **HNBR rubber or SILICONE rubber** and have been incorporated in the base flange on bulkhead mounting housings for easier installation.

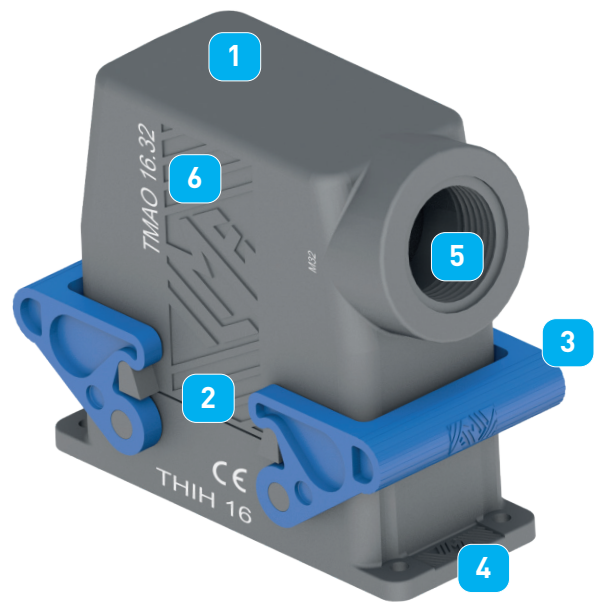
3 Levers

The locking levers have been produced in **self-extinguishing metal detectable thermoplastic material**, blue colour.

In accordance with the requirements set forth in **EHEDG Guideline n. 32** "Materials of construction for food equipment in contact with food" (EHEDG = European Hygienic Engineering & Design Group), the closing levers and sealing gaskets are coloured blue to easily identify any accidental contaminations in food products and to facilitate the visual identification of their complete cleanliness.

4 Dimensions

The internal dimensions allow mounting of all connector inserts in their relevant sizes. The external dimensions of the bulkhead mounting housings are similar to those of the corresponding metallic enclosures; hole fixing centres are unchanged. Hoods offer an inner cabling space similar to that of the "high" construction models of the corresponding metal enclosures. Other characteristics are in compliance with the applicable safety standard for electrical connectors, **IEC/EN 61984**.



5 Cable entries

The housing and hood cable entries are available with metric thread, respectively:

- **M25 or M32** for smaller sizes "44.27" and "57.27".
- **M32 or M40** for larger sizes "77.27" and "104.27".

The recent standard **IEC/EN 61076-7-100** regarding metric cable entries for multipole electrical connectors for heavy duty uses, which standardises some main dimensions for entries and their related accessories (gaskets, pressure nuts), have been carefully considered in the product design.

6 Markings

Each enclosure carries its own part number and conformity markings.

T-TYPE / H production lines HYGIENIC SERIES

inserts		page:
CDD	24 poles + ⊕	76
CDS	9 poles + ⊕	-
CDSH	9 poles + ⊕	86
CDSH NC	6 poles + ⊕	95
CNE	6 poles + ⊕	110
CSE	6 poles + ⊕	-
CSH	6 poles + ⊕	110
CSH S	6 poles + ⊕	122
CCE	6 poles + ⊕	130
CSS	6 poles + ⊕	148
CT, CTSE (16A) *)	6 poles + ⊕	160
CQE	10 poles + ⊕	168
MIXO	2 modules	262 - 317

*) only for standard insulating version THIH

housings with single lever HNBR gasket

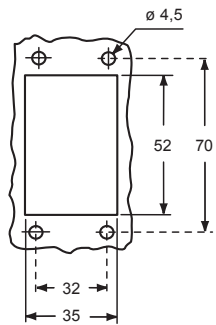


hoods with single lever, top entry covers, HNBR gasket



description	part No.	entry M	part No.	entry M	part No. (with loop)
bulkhead mounting housing with thermoplastic lever	THIH 06 L				
surface mounting housing, thermoplastic lever, high construction	TAPH 06 L25	25			
surface mounting housing, thermoplastic lever, high construction with thermoplastic lever and gasket, high construction	TAPH 06 L32	32			
with thermoplastic lever and gasket, high construction			TAVH 06 LG25	25	
cover with thermoplastic lever and gasket			TAVH 06 LG32	32	
					THCH 06 LG

panel cut-out for bulkhead mounting housings

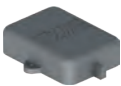


TMAO
Hoods
(page 480)

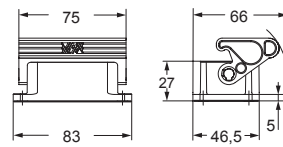


TMAV
Hoods
(page 480)

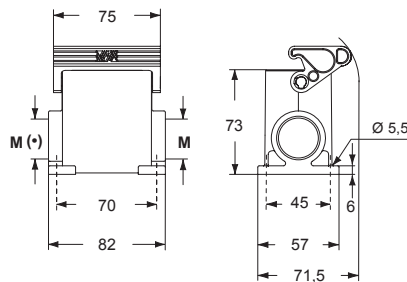
TCHC L
TCHC SL
Covers
with eyelet
(page 481)



THIH L

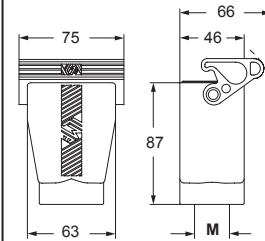


TAPH L

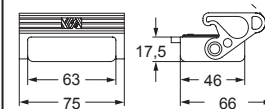


(+) The surface mounting, high construction housings are supplied with an open threaded entry (+) and diametrically opposite a closed threaded entry which can be opened by the user if required (with suitable tool).

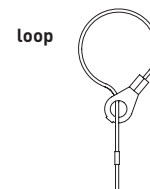
TAVH LG



THCH LG



For fixing on hoods



CE **RU** **US** Type 12



ambient temperature limits -40 °C / +70 °C

T-TYPE / H production lines HYGIENIC SERIES

inserts		page:
CDD	42 poles + ⊕	78
CDS	18 poles + ⊕	-
CDSH	18 poles + ⊕	87
CNE	10 poles + ⊕	111
CSE	10 poles + ⊕	-
CSH	10 poles + ⊕	111
CSH S	10 poles + ⊕	123
CCE	10 poles + ⊕	131
CMSH	3+2 (aux) poles + ⊕	136
CMCE	3+2 (aux) poles + ⊕	137
CSS	10 poles + ⊕	149
CT, CTSE (16A) *)	10 poles + ⊕	161
CQE	18 poles + ⊕	169
CX	8/24 poles + ⊕	194
MIXO	3 modules	262 - 317

*) only for standard insulating version THIH

housings with double lever HNBR gasket

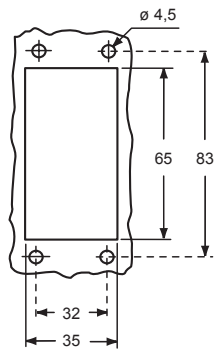


hoods with double lever, top entry covers, HNBR gasket



description	part No.	entry M	part No.	entry M	part No. (with loop)
bulkhead mounting housing with thermoplastic levers	THIH 10				
surface mounting housing, thermoplastic levers, high construction	TAPH 10.25	25			
surface mounting housing, thermoplastic levers, high construction	TAPH 10.32	32			
with thermoplastic levers and gasket, high construction			TAVH 10 G25	25	
with thermoplastic levers and gasket, high construction			TAVH 10 G32	32	
cover with 2 thermoplastic levers and gasket					THCH 10 G

panel cut-out for bulkhead mounting housings



TMAO
Hoods
(page 482)

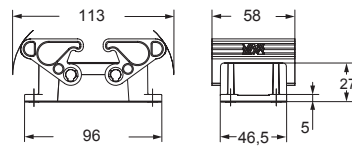


TMAV
Hoods
(page 482)

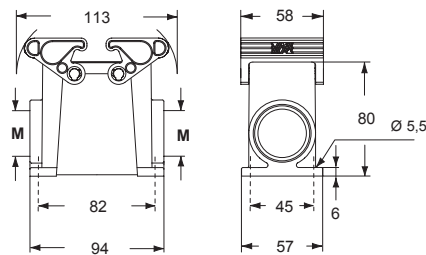
THCH
TCHC S
Covers
with eyelet
(page 483)



THIH

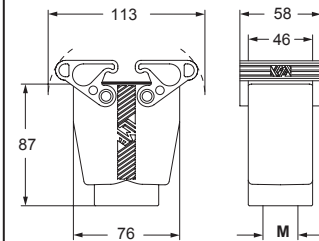


TAPH

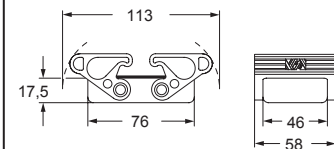


The surface mounting, high construction housings are supplied with an open threaded entry and diametrically opposite a closed threaded entry which can be opened by the user if required (with suitable tool).

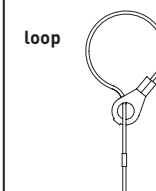
TAVH G



THCH G



For fixing on hoods



CAUS Type 12



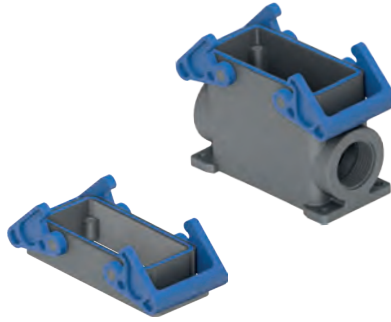
ambient temperature limits -40 °C / +70 °C

T-TYPE / H production lines HYGIENIC SERIES

inserts		page:
CD	40 poles + ⊕	70
CDD	72 poles + ⊕	79
CDS	27 poles + ⊕	-
CDSH	27 poles + ⊕	88
CNE	16 poles + ⊕	112
CSE	16 poles + ⊕	-
CSH	16 poles + ⊕	112
CSH S	16 poles + ⊕	124
CCE	16 poles + ⊕	132
CMSH, CMCE	6+2 (aux) poles + ⊕	138 - 139
CSS	16 poles + ⊕	150
CT, CTSE (16A) *)	16 poles + ⊕	162
CQE	32 poles + ⊕	170
CQEE	40 poles + ⊕	176
CP	6 poles + ⊕	178
CX	6/12, 6/36 and 12/2 poles + ⊕	197 - 199
CX	4/0 and 4/2 poles + ⊕	200 - 201
MIXO	4 modules	262 - 317

*) only for standard insulating version THIH

housings with double lever HNBR gasket

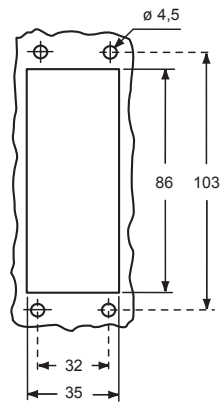


hoods with double lever, top entry covers, HNBR gasket



description	part No.	entry M	part No.	entry M	part No. (with loop)
bulkhead mounting housing with thermoplastic levers	THIH 16				
surface mounting housing, thermoplastic levers, high construction	TAPH 16.32	32			
surface mounting housing, thermoplastic levers, high construction	TAPH 16.40	40			
with thermoplastic levers and gasket, high construction			TAVH 16 G32	32	
with thermoplastic levers and gasket, high construction			TAVH 16 G40	40	
cover with 2 thermoplastic levers and gasket					THCH 16 G

panel cut-out for bulkhead mounting housings



TMAO
Hoods
(page 484)

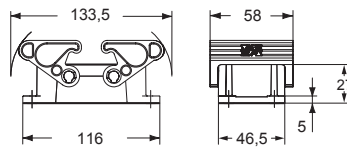


TMAV
Hoods
(page 484)

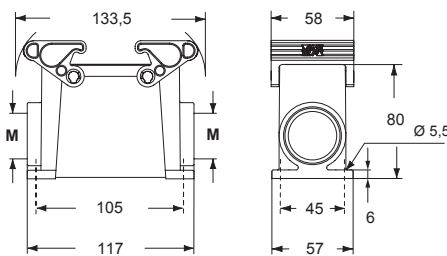
TCHC
TCHC S
Covers
with eyelet
(page 485)



THIH

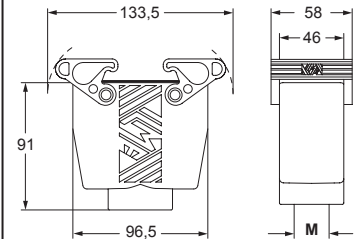


TAPH

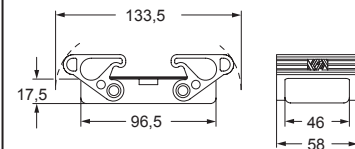


The surface mounting, high construction housings are supplied with an open threaded entry and diametrically opposite a closed threaded entry which can be opened by the user if required (with suitable tool).

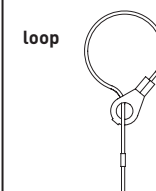
TAVH G



THCH G



For fixing on hoods



CE **RU** **US** Type 12



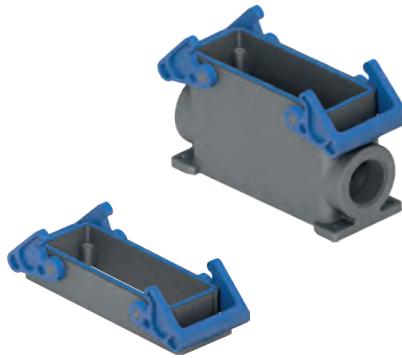
ambient temperature limits -40 °C / +70 °C

T-TYPE / H production lines HYGIENIC SERIES

inserts		page:
CD	64 poles + ⊕	72
CDD	108 poles + ⊕	81
CDS	42 poles + ⊕	-
CDSH	42 poles + ⊕	89
CNE	24 poles + ⊕	113
CSE	24 poles + ⊕	-
CSH	24 poles + ⊕	113
CSH S	24 poles + ⊕	125
CCE	24 poles + ⊕	133
CMSH	10+2 (aux) poles + ⊕	140
CMCE	10+2 (aux) poles + ⊕	141
CSS	24 poles + ⊕	151
CT, CTSE (16A) *	24 poles + ⊕	163
CQE	46 poles + ⊕	171
CQEE	64 poles + ⊕	177
CX	4/8 and 6/6 poles + ⊕	204, 206
MIXO	6 modules	262 - 317

*) only for standard insulating version THIH

housings with double lever HNBR gasket

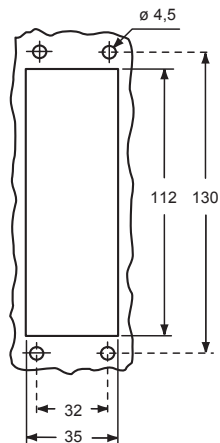


hoods with double lever, top entry covers, HNBR gasket



description	part No.	entry M	part No.	entry M	part No. (with loop)
bulkhead mounting housing with thermoplastic levers	THIH 24				
surface mounting housing, thermoplastic levers, high construction	TAPH 24.32	32			
surface mounting housing, thermoplastic levers, high construction	TAPH 24.40	40			
with thermoplastic levers and gasket, high construction			TAVH 24 G32	32	
with thermoplastic levers and gasket, high construction			TAVH 24 G40	40	
cover with 2 thermoplastic levers and gasket					THCH 24 G

panel cut-out for bulkhead mounting housings



TMAO
Hoods
(page 486)

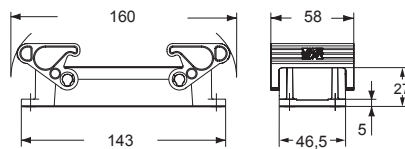


TMAV
Hoods
(page 486)

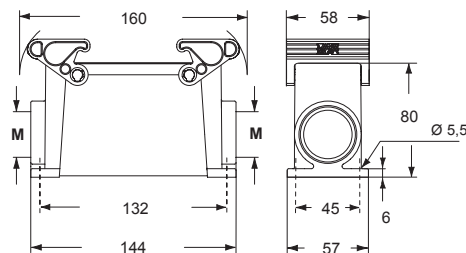
TCHC
TCHC S
Covers
with eyelet
(page 487)



THIH

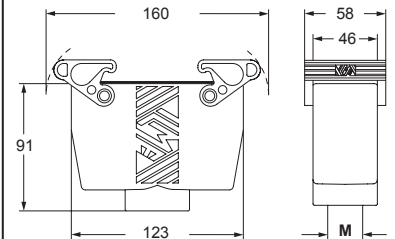


TAPH

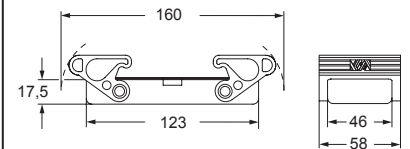


The surface mounting, high construction housings are supplied with an open threaded entry and diametrically opposite a closed threaded entry which can be opened by the user if required (with suitable tool).

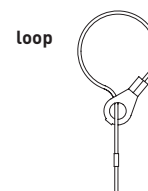
TAVH G



THCH G



For fixing on hoods



CAUS® Type 12



ambient temperature limits -40 °C / +70 °C

AH M25IF(L) - AH M32IF(L) cable glands HYGIENIC SERIES

enclosures:
HYGIENIC T-TYPE / H IP66/IP69
(only M25 or M32)

page:
501 - 504

HYGIENIC M25 cable gland



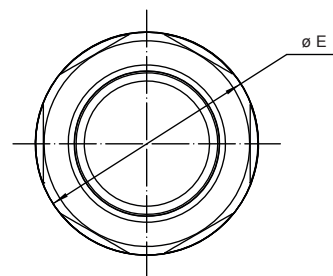
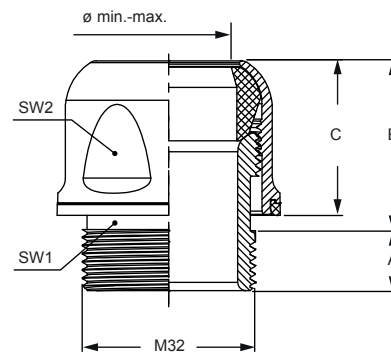
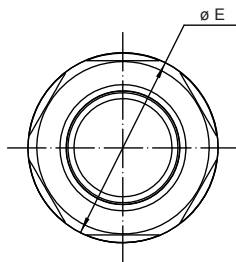
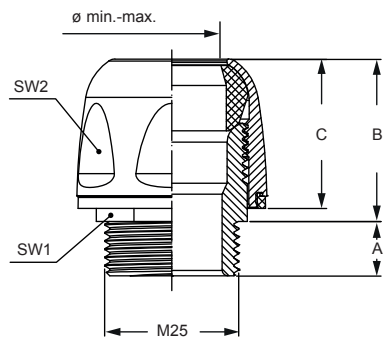
HYGIENIC M32 cable gland



description	part No.	M threading	part No.	M threading
cable glands M25X1,5 for cable \varnothing 12,0-15,0 for cable \varnothing 15,0-18,0	AH M25IF AH M25IFL	M25 M25	AH M32IF AH M32IFL	M32 M32

- NOTE: For details about their installation refer to the instruction sheet accompanying the product:
- ECOLAB compliant
 - EHEDG compliant
 - IP68, IP69 degree of protection
 - ambient temperature limit: -20 °C ... +85 °C
 - cULus (UL Recognized Component for USA and Canada), cUL (UL Listed Product for USA and Canada), ENEC certified

Designed and certified in accordance with the EHEDG guidelines



part No.	A	B	C	SW1	SW2	\varnothing E	\varnothing min.-max.
AH M25IF	10	30	27	24	32	34,9	12,0-15,0
AH M25IFL	10	30	27	24	32	34,9	15,0-18,0

part No.	A	B	C	SW1	SW2	\varnothing E	\varnothing min.-max.
AH M32IF	11	32	28	30	38	40,9	18,0-21,0
AH M32IFL	11	32	28	30	38	40,9	20,0-23,0

T-TYPE / C low-temperature HYGIENIC SERIES

inserts		page:
CDD	24 poles + ⊕	76
CDS	9 poles + ⊕	-
CDSH	9 poles + ⊕	86
CDSH NC	6 poles + ⊕	95
CNE	6 poles + ⊕	110
CSE	6 poles + ⊕	-
CSH	6 poles + ⊕	110
CSH S	6 poles + ⊕	122
CCE	6 poles + ⊕	130
CSS	6 poles + ⊕	148
CT, CTSE (16A) *)	6 poles + ⊕	160
CQE	10 poles + ⊕	168
MIXO	2 modules	262 - 317

*) only for standard insulating version THIC

housings with single lever SILICONE gasket

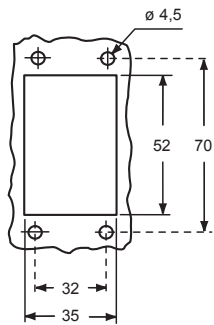


hoods with single lever, top entry covers, SILICONE gasket



description	part No.	entry M	part No.	entry M	part No. (with loop)
bulkhead mounting housing with thermoplastic lever	THIC 06 L				
surface mounting housing, thermoplastic lever, high construction	TAPC 06 L25	25			
surface mounting housing, thermoplastic lever, high construction with thermoplastic lever and gasket, high construction	TAPC 06 L32	32			
with thermoplastic lever and gasket, high construction			TAVC 06 LG25	25	
cover with thermoplastic lever and gasket			TAVC 06 LG32	32	
					THCC 06 LG

panel cut-out for bulkhead mounting housings

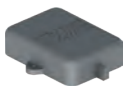


TMA0 Hoods
(page 480)

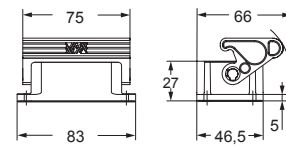


TMAV Hoods
(page 480)

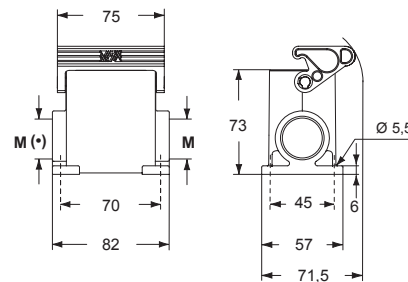
**TCHC L
TCHC SL
Covers with eyelet**
(page 481)



THIC L

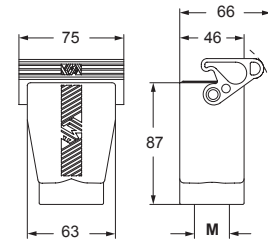


TAPC L

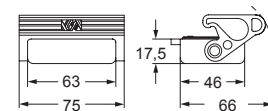


(*) The surface mounting, high construction housings are supplied with an open threaded entry (*) and diametrically opposite a closed threaded entry which can be opened by the user if required (with suitable tool).

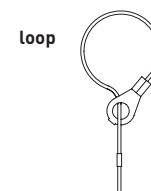
TAVC LG



THCC LG



For fixing on hoods



CAUS Type 12



ambient temperature limits -50 °C / +70 °C

T-TYPE / C low-temperature HYGIENIC SERIES

inserts		page:
CDD	42 poles + ⊕	78
CDS	18 poles + ⊕	-
CDSH	18 poles + ⊕	87
CNE	10 poles + ⊕	111
CSE	10 poles + ⊕	-
CSH	10 poles + ⊕	111
CSH S	10 poles + ⊕	123
CCE	10 poles + ⊕	131
CMSH	3+2 (aux) poles + ⊕	136
CMCE	3+2 (aux) poles + ⊕	137
CSS	10 poles + ⊕	149
CT, CTSE (16A) *)	10 poles + ⊕	161
CQE	18 poles + ⊕	169
CX	8/24 poles + ⊕	194
MIXO	3 modules	262 - 317

*) only for standard insulating version THIC

housings with double lever SILICONE gasket

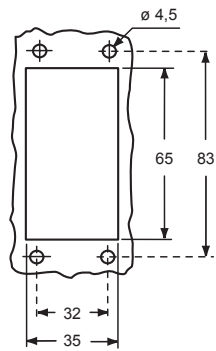


hoods with double lever, top entry covers, SILICONE gasket



description	part No.	entry M	part No.	entry M	part No. (with loop)
bulkhead mounting housing with thermoplastic levers	THIC 10				
surface mounting housing, thermoplastic levers, high construction	TAPC 10.25	25			
surface mounting housing, thermoplastic levers, high construction	TAPC 10.32	32			
with thermoplastic levers and gasket, high construction			TAVC 10 G25	25	
with thermoplastic levers and gasket, high construction			TAVC 10 G32	32	
cover with 2 thermoplastic levers and gasket					THCC 10 G

panel cut-out for bulkhead mounting housings



**TMAO
Hoods
(page 482)**

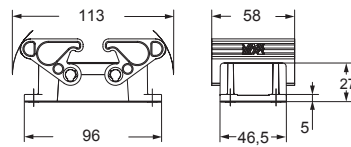


**TMAV
Hoods
(page 482)**

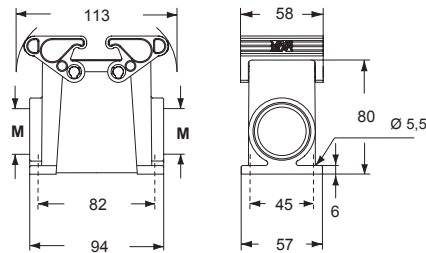
**TCHC
TCHC S
Covers
with eyelet
(page 483)**



THIC

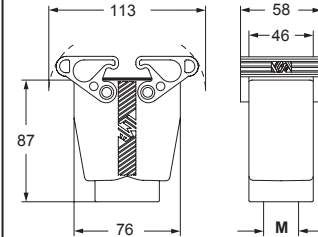


TAPC

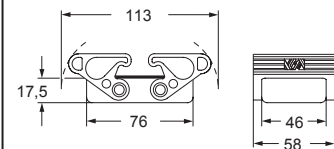


The surface mounting, high construction housings are supplied with an open threaded entry and diametrically opposite a closed threaded entry which can be opened by the user if required (with suitable tool).

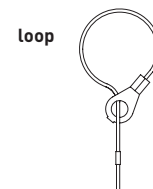
TAVC G



THCC G



For fixing on hoods



CE **RU** **US** Type 12



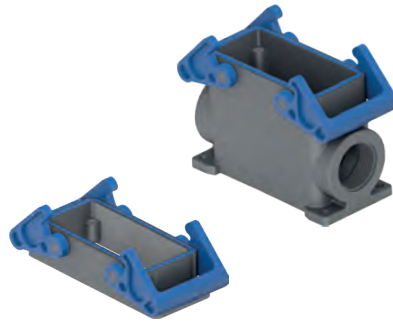
ambient temperature limits -50 °C / +70 °C

T-TYPE / C low-temperature HYGIENIC SERIES

inserts		page:
CD	40 poles + ⊕	70
CDD	72 poles + ⊕	79
CDS	27 poles + ⊕	-
CDSH	27 poles + ⊕	88
CNE	16 poles + ⊕	112
CSE	16 poles + ⊕	-
CSH	16 poles + ⊕	112
CSH S	16 poles + ⊕	124
CCE	16 poles + ⊕	132
CMSH, CMCE	6+2 (aux) poles + ⊕	138 - 139
CSS	16 poles + ⊕	150
CT, CTSE (16A) *)	16 poles + ⊕	162
CQE	32 poles + ⊕	170
CQEE	40 poles + ⊕	176
CP	6 poles + ⊕	178
CX	6/12, 6/36 and 12/2 poles + ⊕	197 - 199
CX	4/0 and 4/2 poles + ⊕	200 - 201
MIXO	4 modules	262 - 317

*) only for standard insulating version THIC

housings with double lever SILICONE gasket

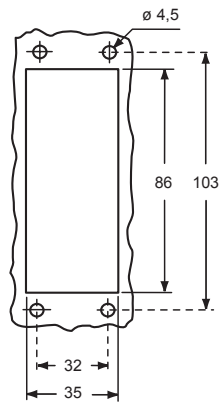


hoods with double lever, top entry covers, SILICONE gasket



description	part No.	entry M	part No.	entry M	part No. (with loop)
bulkhead mounting housing with thermoplastic levers	THIC 16				
surface mounting housing, thermoplastic levers, high construction	TAPC 16.32	32			
surface mounting housing, thermoplastic levers, high construction	TAPC 16.40	40			
with thermoplastic levers and gasket, high construction			TAVC 16 G32	32	
with thermoplastic levers and gasket, high construction			TAVC 16 G40	40	
cover with 2 thermoplastic levers and gasket					THCC 16 G

panel cut-out for bulkhead mounting housings



TMAO
Hoods
(page 484)

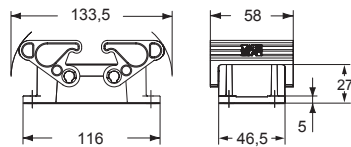


TMAV
Hoods
(page 484)

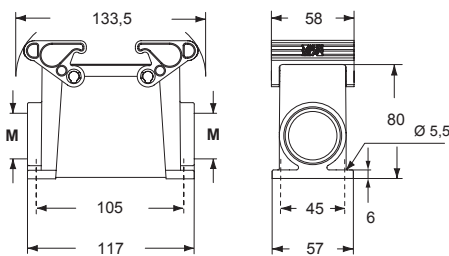
TCHC
TCHC S
Covers
with eyelet
(page 485)



THIC

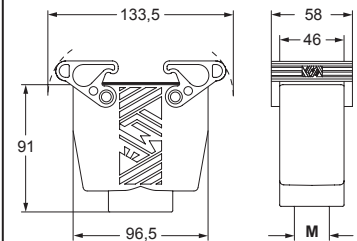


TAPC

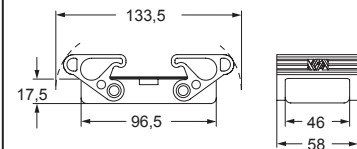


The surface mounting, high construction housings are supplied with an open threaded entry and diametrically opposite a closed threaded entry which can be opened by the user if required (with suitable tool).

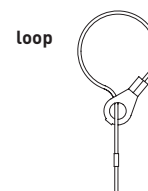
TAVC G



THCC G



For fixing on hoods



CAUS Type 12



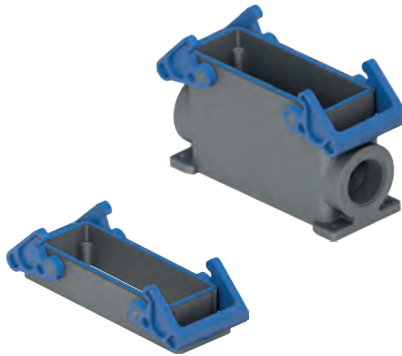
ambient temperature limits -50 °C / +70 °C

T-TYPE / C low-temperature HYGIENIC SERIES

inserts		page:
CD	64 poles + ⊕	72
CDD	108 poles + ⊕	81
CDS	42 poles + ⊕	-
CDSH	42 poles + ⊕	89
CNE	24 poles + ⊕	113
CSE	24 poles + ⊕	-
CSH	24 poles + ⊕	113
CSH S	24 poles + ⊕	125
CCE	24 poles + ⊕	133
CMSH	10+2 (aux) poles + ⊕	140
CMCE	10+2 (aux) poles + ⊕	141
CSS	24 poles + ⊕	151
CT, CTSE (16A) *)	24 poles + ⊕	163
CQE	46 poles + ⊕	171
CQEE	64 poles + ⊕	177
CX	4/8 and 6/6 poles + ⊕	204, 206
MIXO	6 modules	262 - 317

*) only for standard insulating version THIC

housings with double lever SILICONE gasket

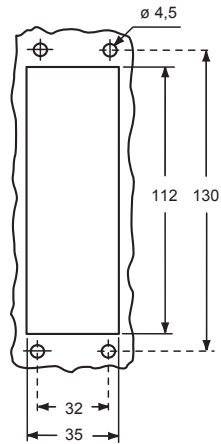


hoods with double lever, top entry covers, SILICONE gasket



description	part No.	entry M	part No.	entry M	part No. (with loop)
bulkhead mounting housing with thermoplastic levers	THIC 24				
surface mounting housing, thermoplastic levers, high construction	TAPC 24.32	32			
surface mounting housing, thermoplastic levers, high construction	TAPC 24.40	40			
with thermoplastic levers and gasket, high construction			TAVC 24 G32	32	
with thermoplastic levers and gasket, high construction			TAVC 24 G40	40	
cover with 2 thermoplastic levers and gasket					THCC 24 G

panel cut-out for bulkhead mounting housings



TMAO
Hoods
(page 486)

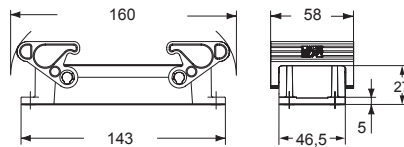


TMAV
Hoods
(page 486)

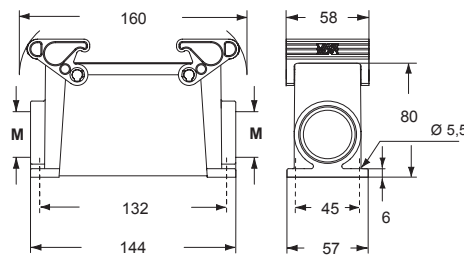
TCHC
TCHC S
Covers
with eyelet
(page 487)



THIC

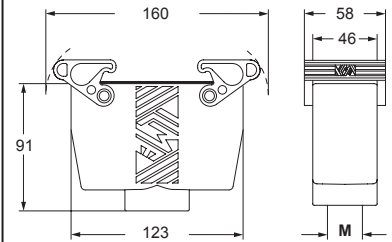


TAPC

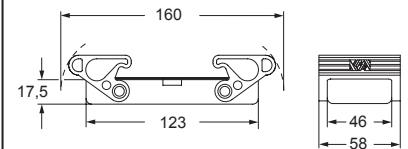


The surface mounting, high construction housings are supplied with an open threaded entry and diametrically opposite a closed threaded entry which can be opened by the user if required (with suitable tool).

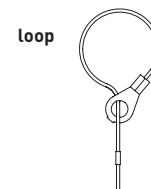
TAVC G



THCC G



For fixing on hoods



CE **RU** [®] **US** Type 12

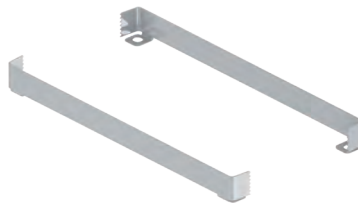


ambient temperature limits -50 °C / +70 °C

CR..BPE PE earth jumpers

inserts		page:
CD	40, 64 poles + ⊕	70, 72
CDD	24, 42, 72, 108 poles + ⊕	76 - 81
CDS	9, 18, 27, 42 poles + ⊕	-
CDSH	9, 18, 27, 42 poles + ⊕	86 - 89
CNE	6, 10, 16, 24 poles + ⊕	110 - 113
CSE	6, 10, 16, 24 poles + ⊕	-
CSH	6, 10, 16, 24 poles + ⊕	110 - 113
CSH S	6, 10, 16, 24 poles + ⊕	122 - 125
CCE	6, 10, 16, 24 poles + ⊕	130 - 133
CMSH	3, 6, 10 +2 (aux) poles + ⊕	136 - 140
CMCE	3, 6, 10 +2 (aux) poles + ⊕	137 - 141
CSS	6, 10, 16, 24 poles + ⊕	148 - 151
CT, CTSE	6, 10, 16, 24 poles + ⊕	160 - 163
CQE	10, 18, 32, 46 poles + ⊕	168 - 171
CQEE	40, 64 poles + ⊕	176 - 177
CP	6 poles + ⊕	178
CX	8/24, 6/36, 12/2 poles + ⊕	194 - 199

PE optional earth jumpers



description

part No.

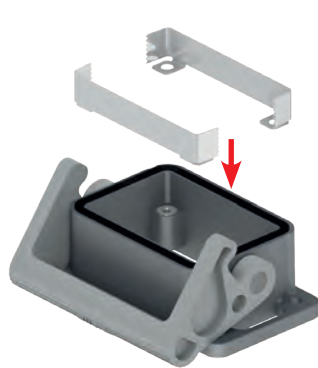
galvanized brass, to be optionally used with T-TYPE enclosures series:
 for inserts "44.27" size
 for inserts "57.27" size
 for inserts "77.27" size
 for inserts "104.27" size

CR 06 BPE
CR 10 BPE
CR 16 BPE
CR 24 BPE

CR...BPE accessories PE (protective earth) jumpers could be mounted under the connector inserts for the connection of the two insert's PE plates.

To guarantee to proper alignment of the insert inside the enclosure, it is necessary to use both jumpers supplied (in the same housing or hood); the jumpers are not usable individually.

Furthermore the user is responsible for verifying the continuity of the PE connection ⊕ (male and female) independently of using CR...BPE earth jumpers.



Optional earth jumpers

T-TYPE - ACCESSORIES

W-TYPE

ENCLOSURES for aggressive environments

A cornerstone against corrosion

Series W-TYPE connector enclosures for aggressive environments is specially **designed for industrial applications where particularly aggressive external agents are present** (e.g. salty environments, etc.).

The range includes enclosures in the 7 basic sizes (size 21.21 for CKA..W and MKA..W models, sizes 44.27, 57.27, 77.27 and 104.27 for CH..W, CA..W and MH..W, MA..W models, sizes 49.16 and 66.16 for CZ..W and MZ..W models) and in the 3 double sizes (sizes 66.40 also known as 50 poles, 77.62 a.k.a. 32 poles, 104.62 a.k.a. 48 poles).

Series W-TYPE enclosures may be bulkhead mounting, surface-mounting or hood type with side or top entry. They are **distinguished by the jet black RAL 9005 colour** and have the following characteristics:

- **chromate conversion treatment of castings** RoHS 2 compliant, providing **50% improved corrosion in resistance in salt spray tests** (according to UNI EN ISO 9227) compared to the previous green coloured versions;
- **thermosetting epoxy powder coating** (with improved resistance to chemicals compared to epoxy polyester of the standard enclosures series);
- **FKM fluoroelastomer gaskets** (with improved resistance to chemicals and aging);
- **ambient temperature limits from -40 °C to +125 °C.**

Other constructional characteristics are:

1) CKA..W and MKA..W series

- 21.21 inserts size
- stainless steel monoblock locking lever

2) CH..W, CA..W and MH..W, MA..W series

- 44.27, 57.27, 77.27, 104.27, single inserts sizes and 77.62, 104.62, 66.40 double inserts sizes;
- CLASS type locking levers (stainless steel lever body, springs and pins, lever handle by fibreglass reinforced thermoplastic material);
- stainless steel riveted pegs;

3) CZ..W and MZ..W series

- 49.16, 66.16 inserts size;
- stainless steel monoblock locking lever (body, handle, springs), rolls and pins;
- stainless steel riveted pegs;
- supplementary insulation inside enclosures.



Series **W-TYPE** enclosures are approved by UL with **cRU^{us}** Recognized Component mark for USA and Canada, with protection type ratings **UL Type 4 (= NEMA 4)**, **UL Type 4X (= NEMA 4X)** and **UL Type 12 (= NEMA 12)** according to the American standard ANSI/UL 50 and ANSI/UL 50E and the corresponding Canadian Standards CSA C22.2 No.94.1 and CSA C22.2 No.94.2.

Upon connector complete and fitted with suitably rated cable glands or conduit fittings, series **W-TYPE** enclosures guarantee a **degree of protection IP44** (for size 21.21, **IP66/IP67** using CKR 65(D) kit), or **IP66** (all other sizes) as well as **IP69** according to EN 60529 (the IPX9 test recently added to this standard covers resistance to high pressure and temperature water jetting, jets applied at 80 °C (± 5 °C) at a pressure of 80 bar to 100 bar, 30 s for each angle of inclination 0°, 30°, 60° and 90° with reference to the horizontal plane).

Series **W-TYPE** enclosures **can accommodate all connector inserts** with either crimp, screw, spring or the innovative **SQUICH[®]** connection.



Watch our
W-TYPE enclosure
series video

CKA - MKA W-TYPE for aggressive environments

inserts		page:
CK	3 poles + ⊕	58
CK	4 poles + ⊕	58
CKS	3 poles + ⊕	-
CKS	4 poles + ⊕	-
CKSH	3 poles + ⊕	63
CKSH	4 poles + ⊕	63
CD	8 poles	67
CQ4	2 poles + ⊕	182
CQ4 H	2 poles + ⊕	183
CQ4	3 poles + ⊕	184
CQ	5 poles + ⊕	186
CQ	7 poles + ⊕	187
CQ	12 poles + ⊕	189
CQ	21 poles	190

bulkhead mounting housings straight and angled



hoods

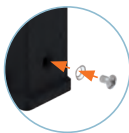


description	part No. (entry Pg 11)	part No. (entry M20)	part No. (entry Pg 11)	part No. (entry M20 / M25)
with stainless steel lever and gasket	CKAXW 03 I			
without cable entry, with stainless steel lever and gasket ¹⁾	CKAXW 03 IA			
with cable entry, with stainless steel lever and gasket ¹⁾	CKAXW 03 IAP	MKAXW IAP20		
with cable entry, with stainless steel lever and gasket, bulkhead hole closed ¹⁾	CKAXW 03 AP	MKAXW AP20		
with pegs, top entry ¹⁾			CKAW 03 V	MKAW V20
with pegs, top entry			CKAW 03 VA	MKAW V25
with pegs, side entry ¹⁾			CKAXW 03 VG	MKAXW VG20
with stainless steel lever, top entry ¹⁾			CKR 65	CKR 65 D
gasket and screw kit for IP66/IP67/IP69 ²⁾ for CK, CKSH, CQ4, CQ inserts	CKR 65		CKR 65	
gasket and screw kit for IP66/IP67/IP69 ²⁾ for CD 08 inserts	CKR 65 D		CKR 65 D	

1) Not suitable for CQ4 series inserts

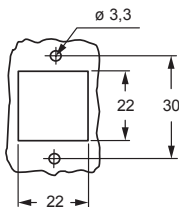
2) To obtain the IP66/IP67/IP69 degree of protection it is necessary to replace the fixing screw supplied with all inserts, with the one with gasket included in the kit (to be purchased separately) **except for** the inserts listed below (already supplied with a fixing screw with gasket):
- CQF/M 07, CQF/M 12

NOTE: The enclosure shown here is an example. The screw and sealing gasket kit can be used with all enclosures' part nos. in this page



versions with glued gasket (DESINA®) upon request

panel cut-out for bulkhead mounting housings

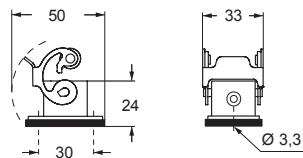


CAIUS®
Type 12
Type 4/4X only
with CKR 65 (D)

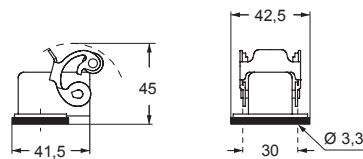


IP66/IP67/IP69 with CKR 65 (D) ²⁾

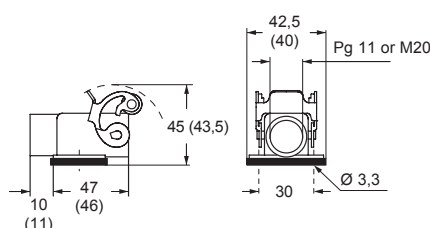
CKAXW I



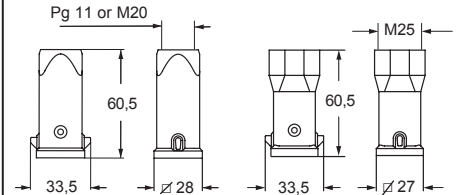
CKAXW IA



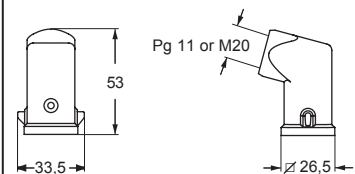
CKAXW IAP (CKAXW AP) and MKAXW IAP (MKAXW AP)



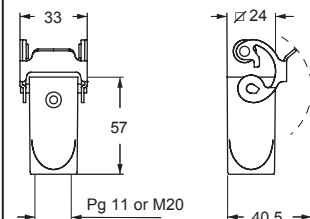
CKAW V and MKAW V20 - V25



CKAW VA and MKAW VA



CKAXW VG and MKAXW VG



CKAX - CKAXX W-TYPE for aggressive environments

inserts		page:
CK	3 poles + ⊕	58
CK	4 poles + ⊕	58
CKS	3 poles + ⊕	-
CKS	4 poles + ⊕	-
CKSH	3 poles + ⊕	63
CKSH	4 poles + ⊕	63
CD	8 poles	67
CQ4	2 poles + ⊕	182
CQ4 H	2 poles + ⊕	183
CQ4	3 poles + ⊕	184
CQ	5 poles + ⊕	186
CQ	7 poles + ⊕	187
CQ	12 poles + ⊕	189
CQ	21 poles	190

angled bulkhead mounting housings stainless steel lever



angled bulkhead mounting housings stainless steel rigid lever



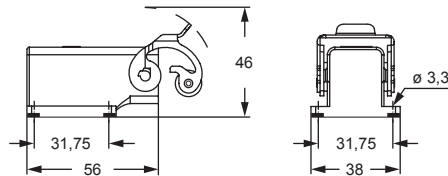
description	part No.	part No.
without cable entry, fixing by 4 screws	CKAXW 03 IA4	CKAXXW 03IA4
gasket and screw kit for IP66/IP67/IP69 ¹⁾ for CK, CKSH, CQ4, CQ inserts	CKR 65	CKR 65
gasket and screw kit for IP66/IP67/IP69 ¹⁾ for CD 08 inserts	CKR 65 D	CKR 65 D

¹⁾ To obtain the IP66/IP67/IP69 degree of protection it is necessary to replace the fixing screw supplied with all inserts, with the one with gasket included in the kit (to be purchased separately) **except for** the inserts listed below (already supplied with a fixing screw with gasket):
 - CQF/M 07, CQF/M 12

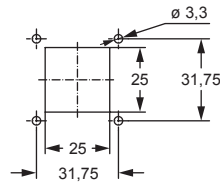
NOTE: The enclosure shown here is an example. The screw and sealing gasket kit can be used with all enclosures' part nos. in this page



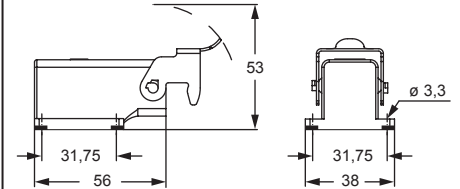
CKAXW IA4



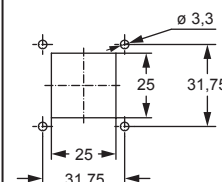
panel cut-out for enclosures



CKAXXW IA4



panel cut-out for enclosures



CAIUS®
 Type 12
 Type 4/4X only
 with CKR 65 (D)

IP44 IP66/IP67/IP69 with CKR 65 (D) ¹⁾

MKAX W-TYPE for aggressive environments

inserts	page:
CK 3 and 4 poles + ⊕	58
CKS 3 and 4 poles + ⊕	-
CKSH 3 and 4 poles + ⊕	63
CD 8 poles	67
CQ4 2 poles + ⊕	182
CQ4 H 2 poles + ⊕	183
CQ4 3 poles + ⊕	184
CQ 5 poles + ⊕	186
CQ 7 poles + ⊕	187
CQ 12 poles + ⊕	189
CQ 21 poles	190

if the counterpart has glued gasket:

CLK 04 SC	239
CX 1/2 BD	243
CXL 2/4 PF/PM	251
CXL 2/4 PFH/PMH	251
CXL PF/PM	251

angled surface mounting housings stainless steel lever



angled surface mounting housings stainless steel lever

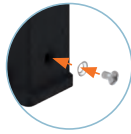


description	part No. (entry M25)	part No. (entry M25)
with cable entry, fixing by 4 screws	MKAXW IAP25	
with cable entry, fixing by 4 screws, bulkhead hole closed (without gasket)		MKAXW AP25
gasket and screw kit for IP66/IP67/IP69 1) for CK, CKSH, CQ4, CQ, inserts	CKR 65	CKR 65
gasket and screw kit for IP66/IP67/IP69 1) for CD 08 inserts	CKR 65 D	CKR 65 D

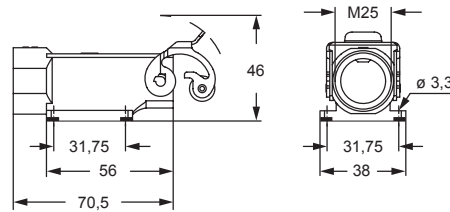
1) To obtain the IP66/IP67/IP69 degree of protection it is necessary to replace the fixing screw supplied with all inserts, with the one with gasket included in the kit (to be purchased separately) **except for** the inserts listed below (already supplied with a fixing screw with gasket):

- CQF/M 07, CQF/M 12
- CUK 2FT /3FT
- CX 1/2 BDF/M
- CLK 04 SCF /SCF-H /SCM
- CXL 2/4 PF /PM /PFH /PMH, CXL PF/PM

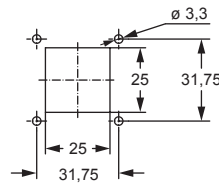
NOTE: The enclosure shown here is an example. The screw and sealing gasket kit can be used with all enclosures' part nos. in this page



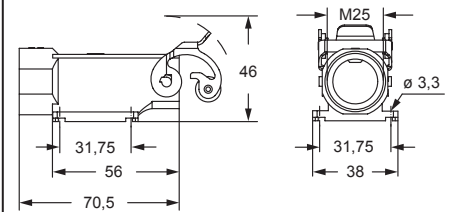
MKAXW IAP25



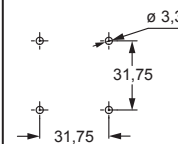
panel cut-out for enclosures



MKAXW AP25



panel cut-out for enclosures



Type 12
Type 4/4X only
with CKR 65 (D)



IP66/IP67/IP69 with CKR 65 (D) 1)

W-TYPE

MKAXX W-TYPE for aggressive environments

inserts	page:
CK 3 and 4 poles + ⊕	58
CKS 3 and 4 poles + ⊕	-
CKSH 3 and 4 poles + ⊕	63
CD 8 poles	67
CQ4 2 poles + ⊕	182
CQ4 H 2 poles + ⊕	183
CQ4 3 poles + ⊕	184
CQ 5 poles + ⊕	186
CQ 7 poles + ⊕	187
CQ 12 poles + ⊕	189
CQ 21 poles	190

if the counterpart has glued gasket:

CLK 04 SC	239
CX 1/2 BD	243
CXL 2/4 PF/PM	251
CXL 2/4 PFH/PMH	251
CXL PF/PM	251

angled surface mounting housings stainless steel rigid lever



angled surface mounting housings stainless steel rigid lever



description	part No. (entry M25)	part No. (entry M25)
with cable entry, fixing by 4 screws	MKAXXW IAP25	
with cable entry, fixing by 4 screws, bulkhead hole closed (without gasket)		MKAXXW AP25
gasket and screw kit for IP66/IP67 ¹⁾ for CK, CKSH, CQ4, CQ, inserts	CKR 65	CKR 65
gasket and screw kit for IP66/IP67 ¹⁾ for CD 08 inserts	CKR 65 D	CKR 65 D

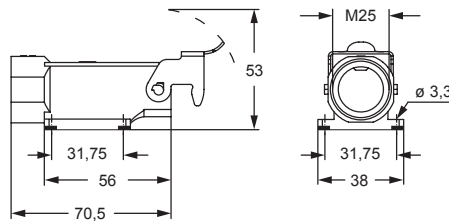
¹⁾ To obtain the IP66/IP67/IP69 degree of protection it is necessary to replace the fixing screw supplied with all inserts, with the one with gasket included in the kit (to be purchased separately) **except for** the inserts listed below (already supplied with a fixing screw with gasket):

- CQF/M 07, CQF/M 12
- CUK 2FT /3FT
- CX 1/2 BDF/M
- CLK 04 SCF /SCF-H /SCM
- CXL 2/4 PF /PM /PFH /PMH, CXL PF/PM

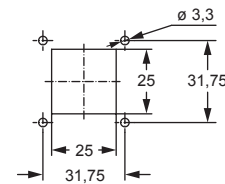
NOTE: The enclosure shown here is an example. The screw and sealing gasket kit can be used with all enclosures' part nos. in this page



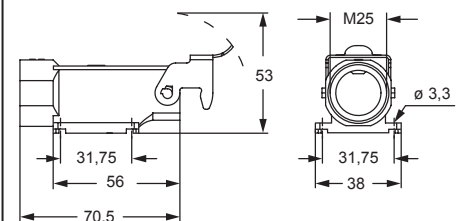
MKAXXW IAP25



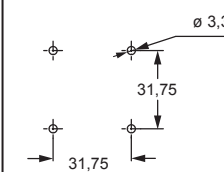
panel cut-out for enclosures



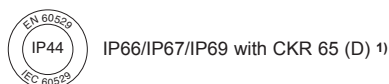
MKAXXW AP25



panel cut-out for enclosures



CAIUS®
Type 12
Type 4/4X only
with CKR 65 (D)



MKAX W-TYPE for aggressive environments

inserts		page:
CK	3 and 4 poles + ⊕	58
CKS	3 and 4 poles + ⊕	-
CKSH	3 and 4 poles + ⊕	63
CD	8 poles	67
CQ4	2 poles + ⊕	182
CQ4 H	2 poles + ⊕	183
CQ4	3 poles + ⊕	184
CQ	5 poles + ⊕	186
CQ	7 poles + ⊕	187
CQ	12 poles + ⊕	189
CQ	21 poles	190

if the counterpart has glued gasket:

CJ KF	223
CJK 8FT	226
CLK 04 SC	239
CX 1/2 BD	243
CXL 2/4 SF/SM	250
CXL SF/SM	250
CXL 2/4 PF/PM	251
CXL 2/4 PFH/PMH	251
CXL PF/PM	251

bulkhead mounting housings stainless steel lever

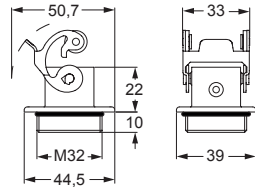
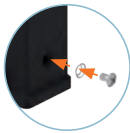


description	part No. (entry M32)
M32 fixing thread (*) 1)	MKAXW IF
gasket and screw kit for IP66/IP67/IP69 1)	CKR 65
gasket and screw kit for IP66/IP67/IP69 1) specific for CD 08 inserts	CKR 65 D

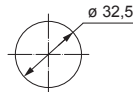
1) To obtain the IP66/IP67/IP69 degree of protection it is necessary to replace the fixing screw supplied with all inserts, with the one with gasket included in the kit (to be purchased separately) **except for** the inserts listed below (already supplied with a fixing screw with gasket):

- CQF/M 07, CQF/M 12
- CJ KF
- CJK 8FT
- CX 1/2 BDF/M
- CLK 04 SCF /SCF-H /SCM
- CXL 2/4 PF /PM /PFH /PMH /SF /SM, CXL SF/M
- CXL PF /PM

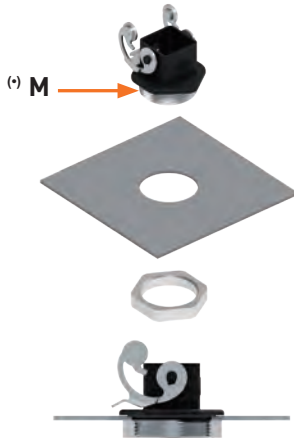
NOTE: The enclosure shown here is an example. The screw and sealing gasket kit can be used with all enclosures' part nos. in this page



panel cut-out for enclosures



(*) Locknut supplied on request, see Cable glands catalogue (article AS M32N metallic).



Type 12
Type 4/4X only
with CKR 65 (D)



IP66/IP67/IP69 with CKR 65 (D) 1)

MKAXX W-TYPE for aggressive environments

inserts		page:
CK	3 and 4 poles + ⊕	58
CKS	3 and 4 poles + ⊕	-
CKSH	3 and 4 poles + ⊕	63
CD	8 poles	67
CQ4	2 poles + ⊕	182
CQ4 H	2 poles + ⊕	183
CQ4	3 poles + ⊕	184
CQ	5 poles + ⊕	186
CQ	7 poles + ⊕	187
CQ	12 poles + ⊕	189
CQ	21 poles	190

if the counterpart has glued gasket:

CJ KF	223
CJK 8FT	226
CLK 04 SC	239
CX 1/2 BD	243
CXL 2/4 SF/SM	250
CXL SF/SM	250
CXL 2/4 PF/PM	251
CXL 2/4 PFH/PMH	251
CXL PF/PM	251

bulkhead mounting housings stainless steel rigid lever



description	part No. (entry M32)
M32 fixing thread (*) 1)	MKAXXW IF
gasket and screw kit for IP66/IP67/IP69 1)	CKR 65
gasket and screw kit for IP66/IP67/IP69 1) specific for CD 08 inserts	CKR 65 D

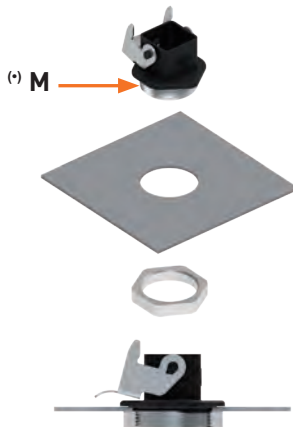
1) To obtain the IP66/IP67/IP69 degree of protection it is necessary to replace the fixing screw supplied with all inserts, with the one with gasket included in the kit (to be purchased separately) **except for** the inserts listed below (already supplied with a fixing screw with gasket):

- CQF/M 07, CQF/M 12
- CJ KF
- CJK 8FT
- CX 1/2 BDF/M
- CLK 04 SCF /SCF-H /SCM
- CXL 2/4 PF /PM /PFH /PMH /SF /SM, CXL SF/M
- CXL PF /PM

☑ NOTE: The enclosure shown here is an example. The screw and sealing gasket kit can be used with all enclosures' part nos. in this page



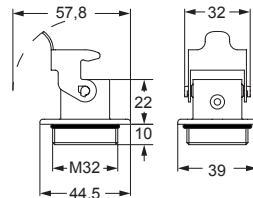
(*) Locknut supplied on request, see Cable glands catalogue (article AS M32N metallic).



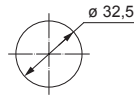
Type 12
Type 4/4X only
with CKR 65 (D)



IP66/IP67/IP69 with CKR 65 (D) 1)



panel cut-out for enclosures



MKAX - MKAXX W-TYPE for aggressive environments

inserts		page:
CK	3 and 4 poles + ⊕	58
CKS	3 and 4 poles + ⊕	-
CKSH	3 and 4 poles + ⊕	63
CD	8 poles	67
CQ4	2 poles + ⊕	182
CQ4 H	2 poles + ⊕	183
CQ4	3 poles + ⊕	184
CQ	5 poles + ⊕	186
CQ	7 poles + ⊕	187
CQ	12 poles + ⊕	189
CQ	21 poles	190

if the counterpart has glued gasket:

CJ KM		223
CJK 8MT		226
CJK 8IMT	226, 228	
CLK 04 SC		239
CX 1/2 BD		243
CXL 2/4 SF/SM		250
CXL SF/SM		250
CXL 2/4 PF/PM		251
CXL 2/4 PFH/PMH		251
CXL PF/PM		251

hoods stainless steel lever



hoods galvanized steel rigid lever



description	part No. (entry M25)	part No. (entry M25)
top entry	MKAXW VG25	MKAXXW VG25
gasket and screw kit for IP66/IP67/IP69 1)	CKR 65	CKR 65
gasket and screw kit for IP66/IP67/IP69 1) specific for CD 08 inserts	CKR 65 D	CKR 65 D

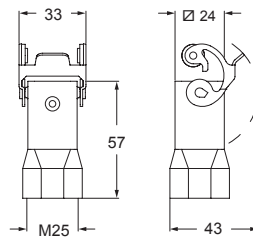
1) To obtain the IP66/IP67/IP69 degree of protection it is necessary to replace the fixing screw supplied with all inserts, with the one with gasket included in the kit (to be purchased separately) **except for** the inserts listed below (already supplied with a fixing screw with gasket):

- CQF/M 07, CQF/M 12
- CJ KM
- CJK 8MT /8IMT
- CX 1/2 BDF/M
- CLK 04 SCF /SCF-H /SCM
- CXL 2/4 PF /PM /PFH /PMH /SF /SM, CXL SF/M
- CXL PF /PM

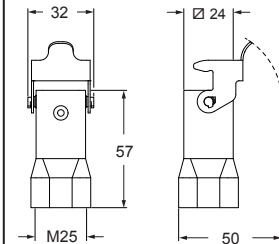
NOTE: The enclosure shown here is an example. The screw and sealing gasket kit can be used with all enclosures' part nos. in this page



MKAXW VG25



MKAXXW VG25



Type 12
Type 4/4X only
with CKR 65 (D)



IP66/IP67/IP69 with CKR 65 (D) 1)

CZ7 - MZ7 CZ - MZ and CZA - MZA W-TYPE for aggressive environments

inserts		page:
CD	15 poles + ⊕	68
CDA	10 poles + ⊕	98
CSAH	10 poles + ⊕	99
CDC	10 poles + ⊕	104
MIXO	1 module	264 - 316

🔗 Covers **cannot be used together** with metal coding pins.

housings and cover

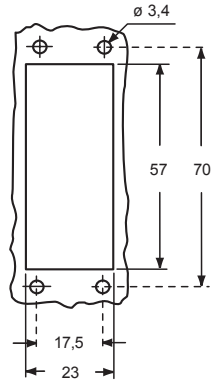


hoods and cover

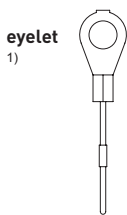


description	part No.	entry Pg	part No.	entry M	part No.	entry Pg	part No.	entry M
bulkhead mounting housing with lever	CZ7IW 15 L	--						
surface mounting housing, with lever	CZ7PW 15 L2	16 x 2	MZ7PW 15L225	25 x 2				
cover with pegs and gasket (for 1 lever enclosures) ¹⁾	CZCW 15 L							
enclosure with pegs and gasket, side entry					CZOW 15 L	16	MZOW 15 L20	20
enclosure with pegs and gasket, side entry							MZOW 15 L25	25
enclosure with pegs and gasket, side entry, high construction					CZAOW 15 L21	21	MZAOW 15 L25	25
enclosure with pegs and gasket, top entry					CZVW 15 L	13,5	MZVW 15 L20	20
enclosure with pegs and gasket, top entry, high construction					CZAVW 15 L21	21	MZAVW 15 L25	25
cover with lever (for enclosures with pegs) ²⁾					CZ7CW 15 LG			

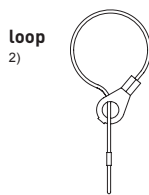
panel cut-out for bulkhead mounting housings



For fixing on housings



For fixing on hoods



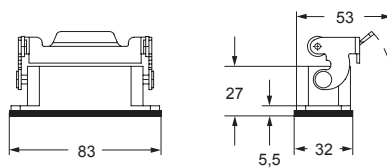
CAVUS® Type 4/4X/12

insulating cable gland or fittings without gasket

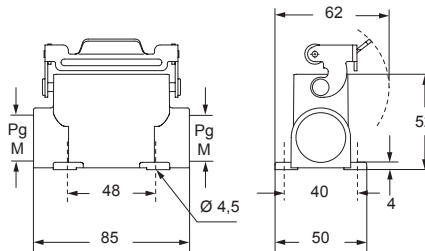
cable gland with O-Ring gasket

cable gland with O-Ring gasket for housings coupled with either a cover or a hood without adapter ● and for hoods coupled with a cover with lever ●

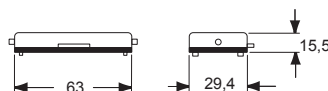
CZ7IW L



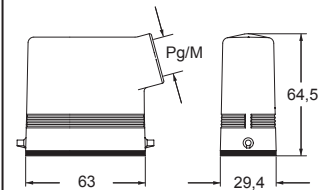
CZ7PW L and MZ7PW L



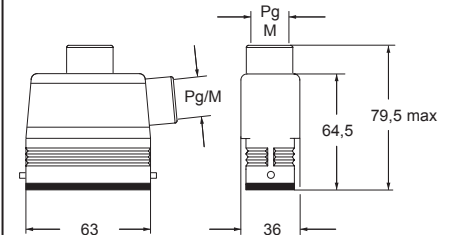
CZCW L ●



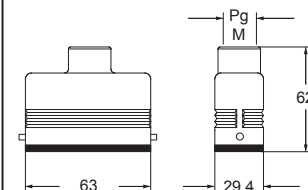
CZOW L and MZOW L ●



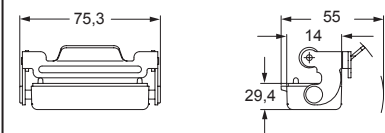
CZAOW L - MZAOW L and CZAVW L - MZAVW L



CZVW L and MZVW L ●



CZ7CW LG ●



CZ7 - MZ7 CZ - MZ and CZA - MZA W-TYPE for aggressive environments

inserts		page:
CD	25 poles + ⊕	69
CDD	38 poles + ⊕	77
CDA	16 poles + ⊕	100
CSAH	16 poles + ⊕	101
CDC	16 poles + ⊕	105

✍ Covers
cannot be used together
 with metal coding pins.

housings and cover

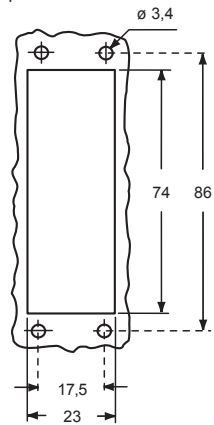


hoods and cover

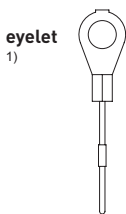


description	part No.	entry Pg	part No	entry M	part No.	entry Pg	part No.	entry M
bulkhead mounting housing with lever	CZ7IW 25 L	--						
surface mounting housing, with lever	CZ7PW 25 L2	16 x 2	MZ7PW 25L225	25 x 2				
cover with pegs and gasket (for 1 lever enclosures) ¹⁾	CZCW 25 L							
enclosure with pegs and gasket, side entry					CZOW 25 L	16	MZOW 25 L20	20
enclosure with pegs and gasket, side entry							MZOW 25 L25	25
enclosure with pegs and gasket, side entry, high construction					CZAOW 25 L21	21	MZAOW 25 L25	25
enclosure with pegs and gasket, top entry					CZVW 25 L	16	MZVW 25 L20	20
enclosure with pegs and gasket, top entry, high construction					CZAVW 25 L21	21	MZAVW 25 L25	25
cover with lever (for enclosures with pegs) ²⁾					CZ7CW 25 LG			

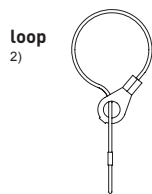
panel cut-out for bulkhead mounting housings



For fixing on housings



For fixing on hoods



CAVUS® Type 4/4X/12



insulating cable gland or fittings without gasket

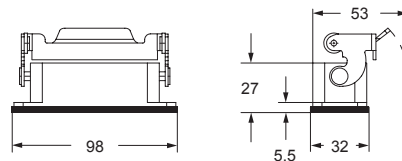


cable gland with O-Ring gasket

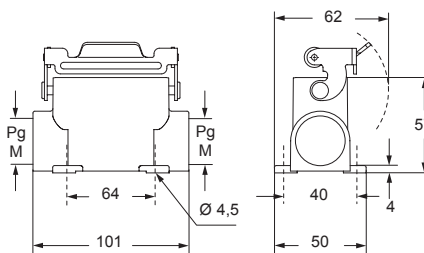


cable gland with O-Ring gasket for housings coupled with either a cover or a hood without adapter ● and for hoods coupled with a cover with lever ●

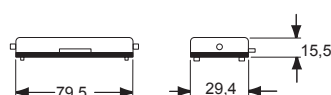
CZ7IW L



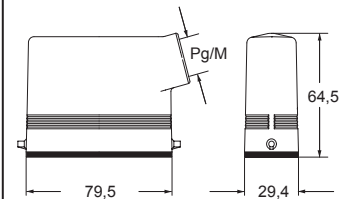
CZ7PW L and MZ7PW L



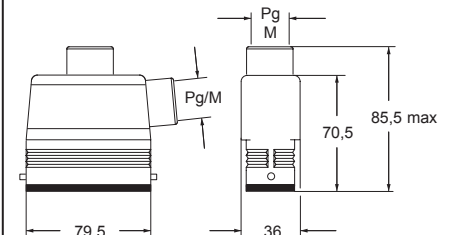
CZCW L ●



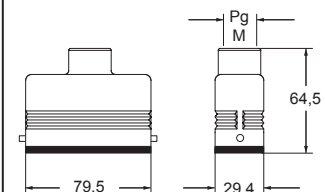
CZOW L and MZOW L ●



CZAOW L - MZAOW L and CZAVW L - MZAVW L

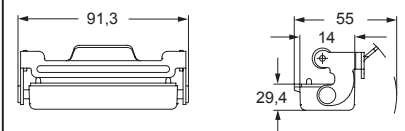


*** CZVW L and MZVW L ●**



* can only be used with a complete cable gland (to be purchased separately)

CZ7CW LG ●



W-TYPE

CH - CA and MA W-TYPE for aggressive environments

inserts		page:
CDD	24 poles + ⊕	76
CDS	9 poles + ⊕	-
CDSH	9 poles + ⊕	86
CDSH NC	6 poles + ⊕	95
CNE	6 poles + ⊕	110
CSE	6 poles + ⊕	-
CSH	6 poles + ⊕	110
CSH S	6 poles + ⊕	122
CCE	6 poles + ⊕	130
CSS	6 poles + ⊕	148
CT, CTSE (16A *)	6 poles + ⊕	160
CQE	10 poles + ⊕	168
MIXO	2 modules	262 - 317

*) only for enclosure CHIW 06 L

housings and cover

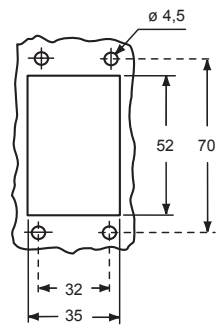


hoods and cover

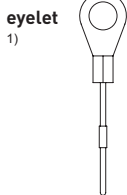


description	part No.	entry Pg	part No	entry M	part No.	entry Pg	part No.	entry M
bulkhead mounting housing with lever and gasket	CHIW 06 L	-						
surface mounting housing, with lever, high construction	CAPW 06 L	21	MAPW 06 L32	32				
cover with pegs (for 1 lever enclosures) 1)	CHCW 06 L							
cover with pegs (for 1 lever enclosures) 2)	CHCW 06 SL							
enclosure with pegs, side entry, high construction					CAOW 06 L21	21	MAOW 06 L32	32
enclosure with pegs, top entry, high construction					CAVW 06 L21	21	MAVW 06 L32	32
cover with lever (for enclosures with pegs) 2)					CHCW 06 LG			
enclosure with lever and gasket, side entry, high construction					CAVW 06 LG	21	MAVW 06 LG32	32

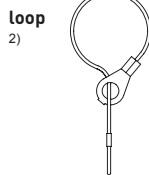
panel cut-out for bulkhead mounting housings



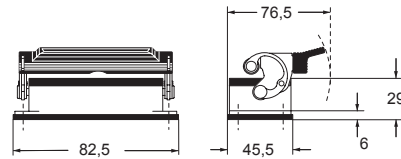
For fixing on housings



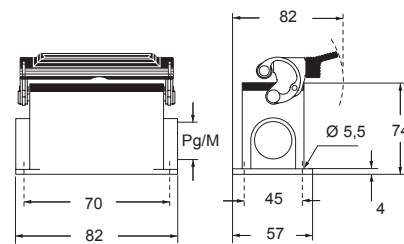
For fixing on hoods



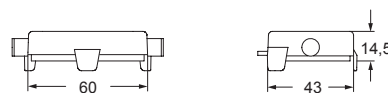
CHIW L



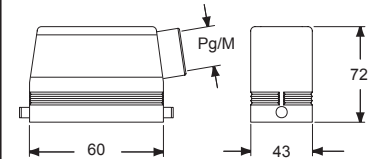
CAPW L and MAPW L



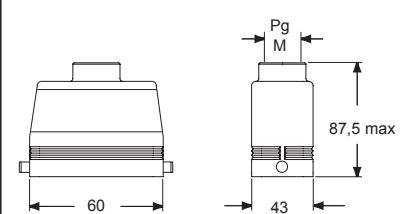
CHCW L - CHCW SL



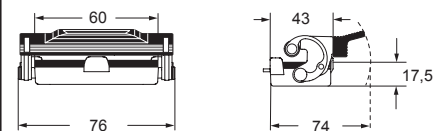
CAOW L and MAOW L



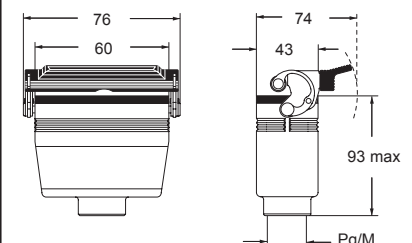
CAVW L and MAVW L



CHCW LG



CAVW LG and MAVW LG



CALUS Type 4/4X/12

insulating cable gland or fittings without gasket

cable gland with O-Ring gasket

CH - CA and MA W-TYPE for aggressive environments

inserts		page:
CDD	42 poles + ⊕	78
CDS	18 poles + ⊕	-
CDSH	18 poles + ⊕	87
CNE	10 poles + ⊕	111
CSE	10 poles + ⊕	-
CSH	10 poles + ⊕	111
CSH S	10 poles + ⊕	123
CCE	10 poles + ⊕	131
CMSH	3+2 (aux) poles + ⊕	136
CMCE	3+2 (aux) poles + ⊕	137
CSS	10 poles + ⊕	149
CT, CTSE (16A) *)	10 poles + ⊕	161
CQE	18 poles + ⊕	169
CX	8/24 poles + ⊕	194
MIXO	3 modules	262 - 317

*) only for enclosure CHIW 10

housings and cover

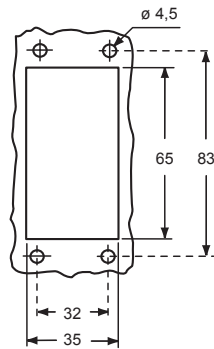


hoods and cover

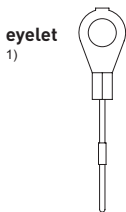


description	part No.		part No.		part No.		part No.	
	entry Pg	entry M	entry Pg	entry M	entry Pg	entry M	entry Pg	entry M
bulkhead mounting housing with levers and gasket		CHIW 10	--					
surface mounting housing, with levers, high construction		CAPW 10.21	21		MAPW 10.32	32		
cover with 4 pegs (for enclosures with 2 levers) ¹⁾		CHCW 10						
cover with 4 pegs (for enclosures with 2 levers) ²⁾		CHCW 10 S						
enclosure with pegs, side entry, high construction					CAOW 10.21	21	MAOW 10.32	32
enclosure with pegs, top entry, high construction					CAVV 10.21	21	MAVV 10.32	32
cover with 2 levers (for enclosures with 4 pegs) ²⁾					CHCW 10 G			
enclosure with levers and gasket, top entry, high construction					CAVV 10 G	21	MAVV 10 G32	32

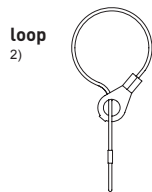
panel cut-out for bulkhead mounting housings



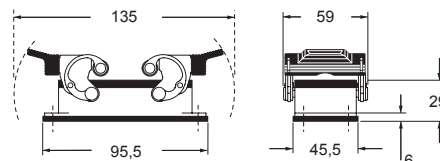
For fixing on housings



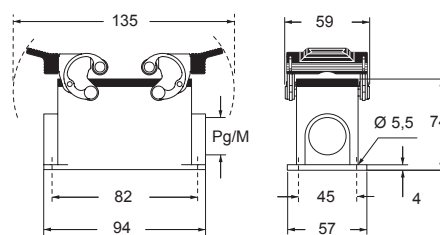
For fixing on hoods



CHIW



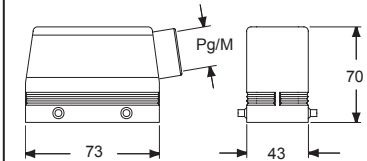
CAPW and MAPW



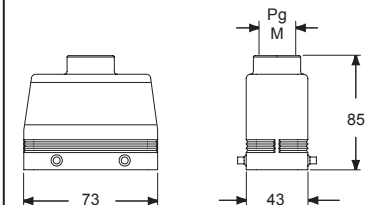
CHCW - CHCW S



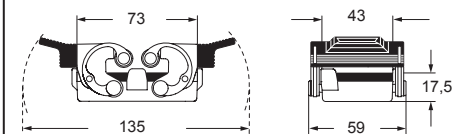
CAOW and MAOW



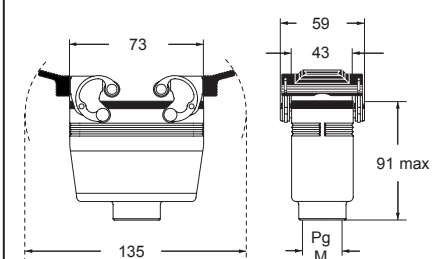
CAVV and MAVV



CHCW G



CAVV G and MAVV G



CAVUS® Type 4/4X/12

insulating cable gland or fittings without gasket

cable gland with O-Ring gasket

W-TYPE

CH - CA and MH - MA W-TYPE for aggressive environments

inserts		page:
CD	40 poles + ⊕	70
CDD	72 poles + ⊕	79
CDS	27 poles + ⊕	-
CDSH	27 poles + ⊕	88
CNE	16 poles + ⊕	112
CSE	16 poles + ⊕	-
CSH	16 poles + ⊕	112
CSH S	16 poles + ⊕	124
CCE	16 poles + ⊕	132
CMSH, CMCE	6+2 (aux) poles + ⊕	138 - 139
CSS	16 poles + ⊕	150
CT, CTS (10A) *)	40 poles + ⊕	156
CT, CTSE (16A) *)	16 poles + ⊕	162
CQE	32 poles + ⊕	170
CQEE	40 poles + ⊕	176
CP	6 poles + ⊕	178
CX	6/12, 6/36 and 12/2 poles + ⊕	197 - 199
CX	4/0 and 4/2 poles + ⊕	200 - 201
MIXO	4 modules	262 - 317

*) only for enclosure CHIW 16

housings and cover

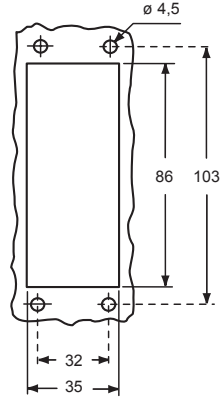


hoods and cover

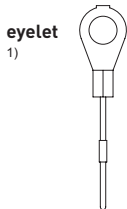


description	part No.	entry Pg	part No.	entry M	part No.	entry Pg	part No.	entry M
bulkhead mounting housing with levers and gasket	CHIW 16	--						
surface mounting housing, with levers, high construction	CAPW 16.21	21	MAPW 16.32	32				
cover with 4 pegs (for enclosures with 2 levers) ¹⁾	CHCW 16							
cover with 4 pegs (for enclosures with 2 levers) ²⁾	CHCW 16 S							
enclosure with pegs, side entry					CHOW 16	21	MHOW 16.25	25
enclosure with pegs, side entry							MHOW 16.32	32
enclosure with pegs, side entry, high construction					CAOW 16.29	29	MAOW 16.32	32
enclosure with pegs, side entry, high construction							MAOW 16.40	40
enclosure with pegs, top entry					CHVW 16	21	MHVW 16.25	25
enclosure with pegs, top entry							MHVW 16.32	32
enclosure with pegs, top entry, high construction					CAVW 16.29	29	MAVW 16.32	32
enclosure with pegs, top entry, high construction							MAVW 16.40	40
cover with 2 levers (for enclosures with 4 pegs) ²⁾					CHCW 16 G			
enclosure with levers and gasket, top entry, high construction					CAVW 16 G29	29	MAVW 16 G32	32

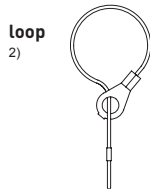
panel cut-out for bulkhead mounting housings



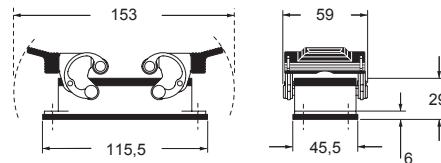
For fixing on housings



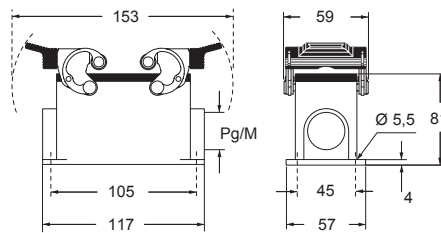
For fixing on hoods



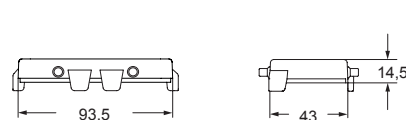
CHIW



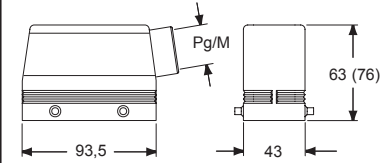
CAPW and MAPW



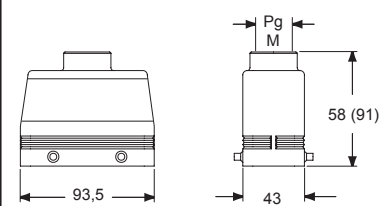
CHCW - CHCW S



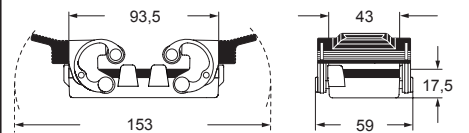
CHOW (CAOW) and MHOW (MAOW)



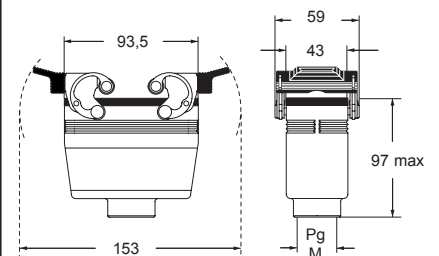
CHVW (CAVW) and MHVW (MAVW)



CHCW G



CAVW G and MAVW G



CRUIS Type 4/4X/12

insulating cable gland or fittings without gasket

cable gland with O-Ring gasket

CH - CA and MH - MA W-TYPE for aggressive environments

inserts		page:
CD	64 poles + ⊕	72
CDD	108 poles + ⊕	81
CDS	42 poles + ⊕	-
CDSH	42 poles + ⊕	89
CNE	24 poles + ⊕	113
CSE	24 poles + ⊕	-
CSH	24 poles + ⊕	113
CSH S	24 poles + ⊕	125
CCE	24 poles + ⊕	133
CMSH	10+2 (aux) poles + ⊕	140
CMCE	10+2 (aux) poles + ⊕	141
CSS	24 poles + ⊕	151
CT, CTS (10A *)	64 poles + ⊕	157
CT, CTSE (16A *)	24 poles + ⊕	163
CQE	46 poles + ⊕	171
CQEE	64 poles + ⊕	177
CX	4/8 and 6/6 poles + ⊕	204, 206
MIXO	6 modules	262 - 317

*) only for enclosure CHIW 24

housings and cover

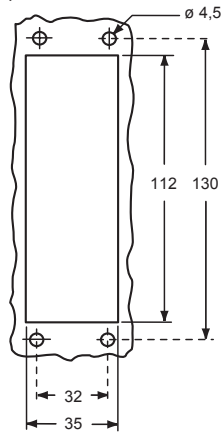


hoods and cover

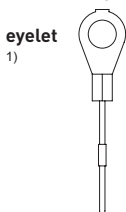


description	part No.	entry Pg	part No	entry M	part No.	entry Pg	part No.	entry M
bulkhead mounting housing with levers and gasket	CHIW 24	--						
surface mounting housing, with levers, high construction	CAPW 24.21	21	MAPW 24.32	32				
cover with 4 pegs (for enclosures with 2 levers) ¹⁾	CHCW 24							
cover with 4 pegs (for enclosures with 2 levers) ²⁾	CHCW 24 S							
enclosure with pegs, side entry					CHOW 24	21	MHOW 24.25	25
enclosure with pegs, side entry							MHOW 24.32	32
enclosure with pegs, side entry, high construction					CAOW 24.29	29	MAOW 24.32	32
enclosure with pegs, side entry, high construction							MAOW 24.40	40
enclosure with pegs, top entry					CHVW 24	21	MHVW 24.25	25
enclosure with pegs, top entry							MHVW 24.32	32
enclosure with pegs, top entry, high construction					CAVW 24.29	29	MAVW 24.32	32
enclosure with pegs, top entry, high construction							MAVW 24.40	40
cover with 2 levers (for enclosures with 4 pegs) ²⁾					CHCW 24 G			
enclosure with levers and gasket, top entry					CHVW 24 G	21	MHVW 24 G32	32

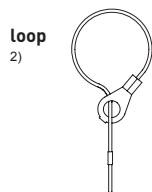
panel cut-out for bulkhead mounting housings



For fixing on housings



For fixing on hoods

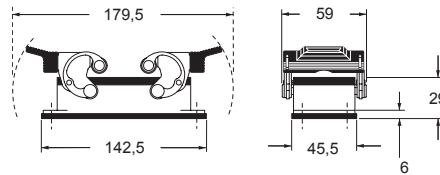


CAVUS® Type 4/4X/12

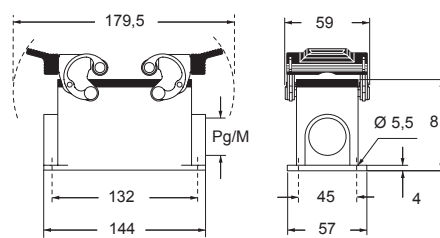
insulating cable gland or fittings without gasket

cable gland with O-Ring gasket

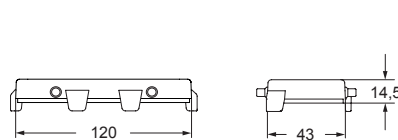
CHIW



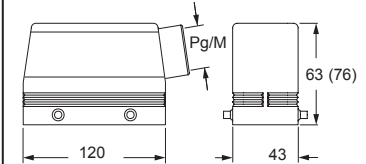
CAPW and MAPW



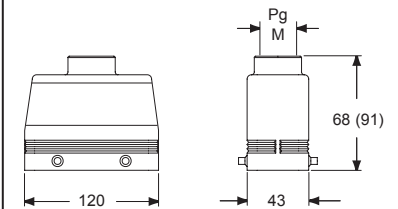
CHCW - CHCW S



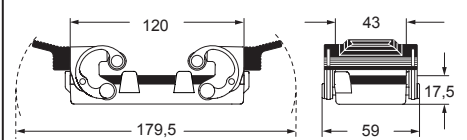
CHOW (CAOW) and MHOW (MAOW)



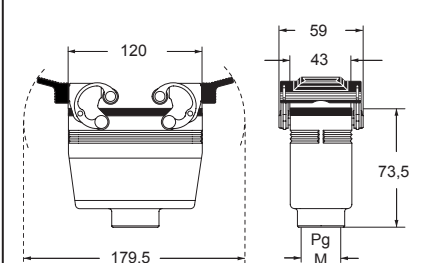
CHVW (CAVW) and MHVW (MAVW)



CHCW G



CHVW G and MHVW G



W-TYPE

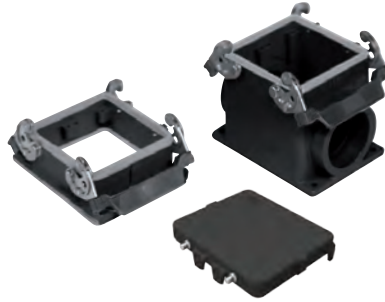
CH and MH W-TYPE for aggressive environments

inserts		page:
CD	80 poles + ⊕	73
CDD	144 poles + ⊕	82
CDS	54 poles + ⊕	-
CDSH	54 poles + ⊕	90
CNE	32 poles + ⊕	114
CSE	32 poles + ⊕	-
CSH	32 poles + ⊕	114
CSH S	32 poles + ⊕	126
CCE	32 poles + ⊕	134
CSS	32 poles + ⊕	152
CTSE (16A) *	32 poles + ⊕	164
CQE	64 poles + ⊕	172
CMSH	12+4 (aux) poles + ⊕	142
CMCE	12+4 (aux) poles + ⊕	143
CP	12 poles + ⊕	179
MIXO	4 + 4 modules	262 - 317

*) only for enclosure CHIW 32

insert dimensions:
2 x (77,5 x 27) mm

housings and cover

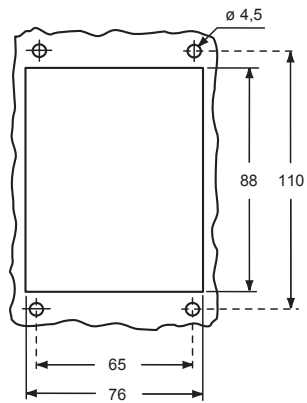


hoods and cover

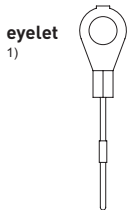


description	part No.	entry Pg	part No	entry M	part No.	entry Pg	part No.	entry M
bulkhead mounting housing with levers and gasket	CHIW 32	--						
surface mounting housing, with levers	CHPW 32	36	MHPW 32.50	50				
cover with 4 pegs (for enclosures with 2 levers) ¹⁾	CHCW 32							
cover with 4 pegs (for enclosures with 2 levers) ²⁾	CHCW 32 S							
enclosure with pegs, side entry					CHOW 32	36	MHOW 32.40	40
enclosure with pegs, top entry					CHVW 32	36	MHVW 32.40	40
cover with 2 levers (for enclosures with 4 pegs) ²⁾					CHCW 32 G			
enclosure with levers and gasket, top entry					CHVW 32 G	36	MHVW 32 G40	40

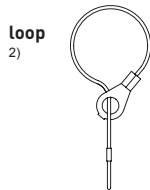
panel cut-out for bulkhead mounting housings



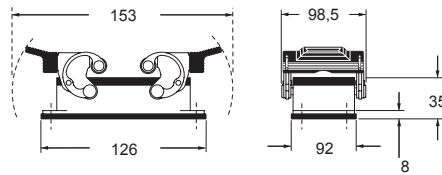
For fixing on housings



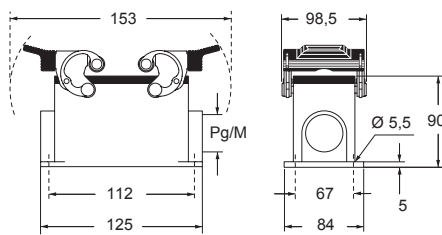
For fixing on hoods



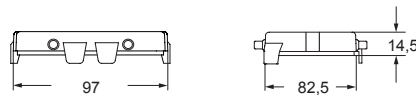
CHIW



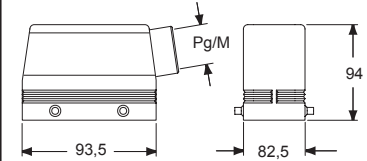
CHPW and MHPW



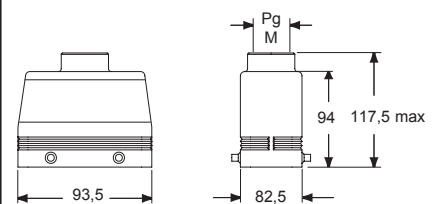
CHCW - CHCW S



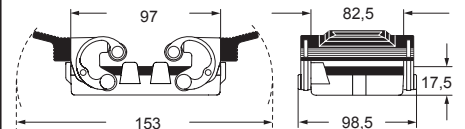
CHOW and MHOW



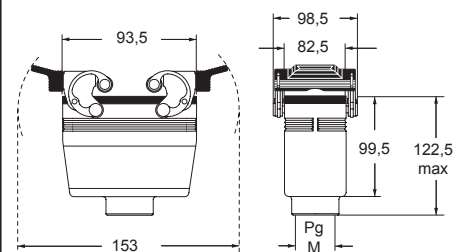
CHVW and MHVW



CHCW G



CHVW G and MHVW G



CRUS Type 4/4X/12

insulating cable gland or fittings without gasket

cable gland with O-Ring gasket

CH and MH W-TYPE for aggressive environments

inserts		page:
CD	128 poles + ⊕	74
CDD	216 poles + ⊕	83
CDS	84 poles + ⊕	-
CDSH	84 poles + ⊕	91
CNE	48 poles + ⊕	115
CSE	48 poles + ⊕	-
CSH	48 poles + ⊕	115
CSH S	48 poles + ⊕	127
CCE	48 poles + ⊕	135
CMSH	20+4 (aux) poles + ⊕	144
CSS	48 poles + ⊕	153
CTSE (16A) *	48 poles + ⊕	165
CQE	92 poles + ⊕	173
MIXO	6 + 6 modules	262 - 317

*) only for enclosure CHIW 48 LS

insert dimensions:
2 x (104 x 27) mm

bulkhead and surface mounting housings

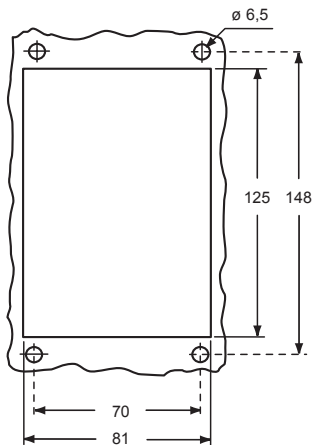


hoods

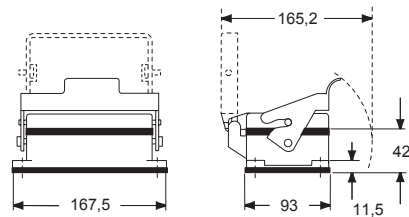


description	part No.	entry Pg	part No.	entry M	part No.	entry Pg	part No.	entry M
bulkhead mounting housings, with lever, gasket and cover	CHIW 48 LS	--						
surface mounting housings, with lever and cover	CHPW 48 LS	36 x 1/2	MHPW 48 LS40	40 x 1/2				
side entry, with pegs					CHOW 48 L	36	MHOW 48 L40	40
top entry, with pegs					CHVW 48 L	36	MHVW 48 L40	40

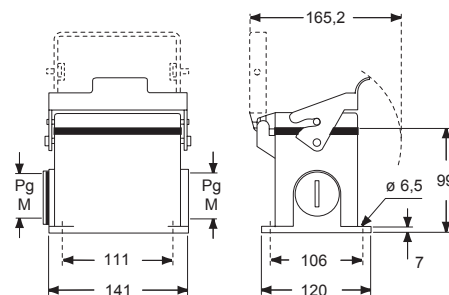
panel cut-out for bulkhead mounting housings



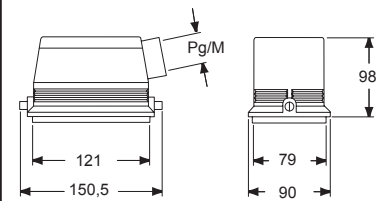
CHIW LS



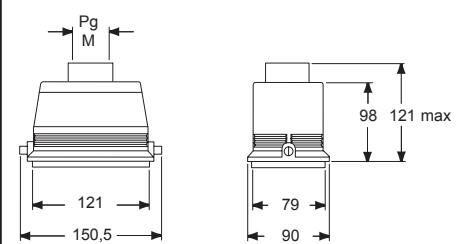
CHPW LS and MHPW LS




CHOW L and MHOW L




CHVW L and MHVW L



CAVUS® Type 4/4X/12

 insulating cable gland or fittings without gasket

 cable gland with O-Ring gasket

W-TYPE

CH - CA and MH - MA W-TYPE for aggressive environments

inserts		page:
CD	50 poles + ⊕	71
CDD	76 poles + ⊕	80
CDA	32 poles + ⊕	102
CSAH	32 poles + ⊕	103
CDC	32 poles + ⊕	106

insert dimensions:
2 x (66 x 16) mm

✍ Covers
cannot be used together
with metal coding pins.

housings and cover

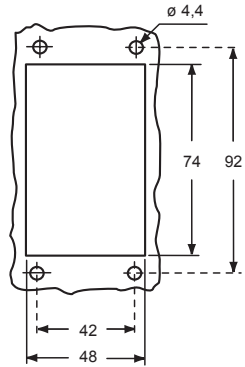


hoods and cover

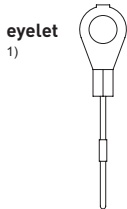


description	part No.	entry Pg	part No.	entry M	part No.	entry Pg	part No.	entry M
bulkhead mounting housings with levers and gasket	CHIW 50	–						
surface mounting housing, with levers	CHPW 50.21	21	MHPW 50.32	32				
surface mounting housing, with levers	CHPW 50.229	29 x 2	MHPW 50.240	40 x 2				
cover with 4 pegs (for housings with 2 levers) ¹⁾	CHCW 50							
cover with 4 pegs (for housings with 2 levers) ²⁾	CHCW 50 S							
enclosure with 4 pegs, side entry					CHOW 50	21	MHOW 50.25	25
enclosure with 4 pegs, side entry							MHOW 50.32	32
enclosure with 4 pegs, side entry, high construction					CAOW 50.29	29	MAOW 50.32	32
enclosure with 4 pegs, top entry, high construction					CAVW 50.29	29	MAVW 50.32	32
cover with 2 levers (for enclosures with 4 pegs) ²⁾					CHCW 50 G			

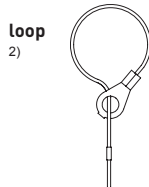
panel cut-out for bulkhead mounting housings



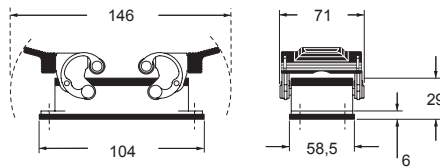
For fixing on housings



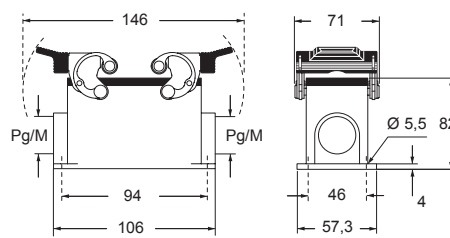
For fixing on hoods



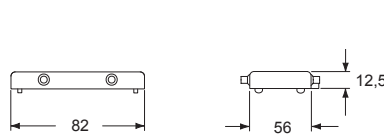
CHIW



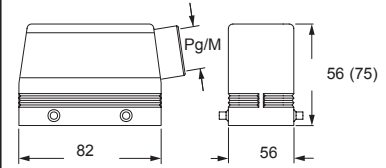
CHPW and MHPW



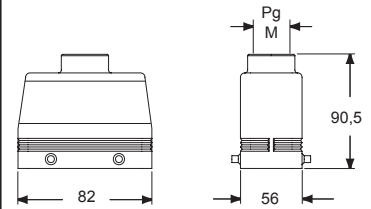
CHCW - CHCW S



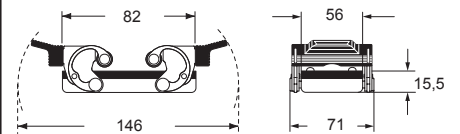
CHOW (CAOW) and MHOW (MAOW)



CAVW and MAVW



CHCW G



CRUIS Type 4/4X/12

insulating cable gland or fittings without gasket

cable gland with O-Ring gasket

E-Xtreme® series

TECHNICAL FEATURES

The protection is granted also in case of impact with stones and sand. The materials are able to withstand UV radiations, a wide temperature range and harsh chemicals.

The E-Xtreme® series is available in the **full range** of ILME aluminum hoods and housings versions.

Applicable test standards

EN 61984:2009-06	Connectors - Safety requirements and tests
EN 60529: 1991 + A1: 2000 + A2: 2013	Degrees of protection provided by enclosures (IP code)
EN ISO 9227: 2012	Corrosion tests in artificial atmospheres - Salt spray tests
ASTM B117-16	Standard practice for operating salt spray (fog) apparatus
EN 60512 (series)	Connectors for electronic equipment - Tests and measurement
EN 60068-2-68: 1996	Environmental testing - Part 2-68: Tests - Test L: Dust and sand
EN ISO 20567-1: 2005	Paints and varnishes -- Determination of stone-chip resistance of coatings -- Part 1: Multi-impact testing

General specifications

Material	Aluminum die-cast
Painting	Epoxy powder coating
Colour	RAL 7016 (dark grey)
Locking lever, springs and pegs	Stainless steel
Lever handle	C-TYPE lever: Polyamide V-TYPE lever: Stainless steel
Gasket	FKM
Silicone-based compounds	Free (except version for -60 °C... +180 °C)
EN ISO 9227: 2012	3.000 hours (V-TYPE lever and hood with moulded pegs) 2.000 hours (C-TYPE lever and hood with riveted stainless steel bolts)
Temperature limits	-40 °C... +180 °C (-60 °C... +180 °C with silicone gasket) (V-TYPE lever and IP68) -40 °C... +125 °C (Class lever and sizes "21.21", "49.16" and "66.16")
Degree of protection according to IEC/EN 60529 (in mated and locked condition)	IP44, IP65/IP69, IP66/IP69, IP66/IP67/IP69, IP66/IP68/IP69
Stone chipping test	ISO 20567-1
Dust and sand blasting test	EN 60068-2-68
Vibration test	EN 61373 cat. 1B, 3 axis EN 60068-2-6 10+500 Hz 0,35mm/5g break point 60, 1 Hz 3 axis
Shock test	EN 61373 cat. 1B, 3 axis
UV resistance	EN ISO 4892-2, EN 50467 on locked housings
Ozone resistance	EN 50467 on locked housings
Chemical resistance	Cleaning fluids, anti-freezing fluids, mineral and synthetic oils, cooling fluids, diesel fuel

E-Xtreme® series

ADVANTAGES

Metal hoods and housings intended for **extremely demanding environments**, with special protective treatment under painting.

Their **special patented protective coating** assures a high level of protection against the corrosion even in case of long term exposure to salt mist.

- 3.000 hours in salt spray tests



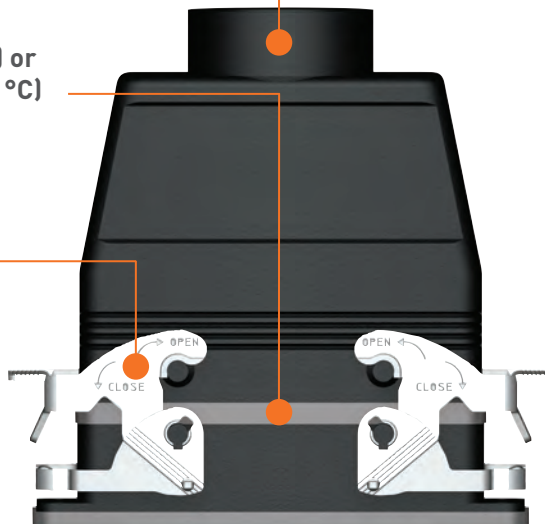
- IP66, IP67, IP69 degree of protection (EN 60529)

- corrosion-proof aluminium with a special coating under the powder painting colour RAL 7016 dark grey

- FKM gasket (-40 °C...+180 °C) or silicone gasket (-60 °C...+180 °C)

- V-TYPE lever or C-TYPE lever, hoods with moulded pegs or riveted stainless steel bolts

- durable protection against damage caused by stone chip, icing, salt mist, UV radiations and harsh gases



icing



very low temperatures



salt mist



impact resistant



UV radiations



chemical resistant



Watch our
E-Xtreme® enclosure
series video

inserts		page:
CDD	42 poles + ⊕	78
CDS	18 poles + ⊕	-
CDSH	18 poles + ⊕	87
CNE	10 poles + ⊕	111
CSE	10 poles + ⊕	-
CSH	10 poles + ⊕	111
CSH S	10 poles + ⊕	123
CCE	10 poles + ⊕	131
CMSH	3+2 (aux) poles + ⊕	136
CMCE	3+2 (aux) poles + ⊕	137
CSS	10 poles + ⊕	149
CT, CTSE (16A) *)	10 poles + ⊕	161
CQE	18 poles + ⊕	169
CX	8/24 poles + ⊕	194
MIXO	3 modules	262 - 317

*) can be used only in bulkhead mounting housings

bulkhead mounting housings with single lever in stainless steel



3.000 HOURS

surface mounting housings with single lever in stainless steel

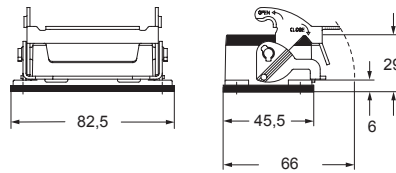


2.000 HOURS

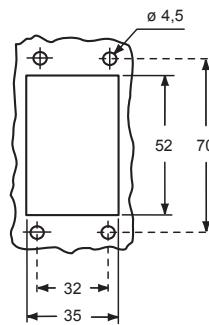
description	part No.	entry
with lever and gasket, size "44.27"	C7IE 06 L	M
with lever, size "44.27"	M7PE 06 L20	20
with lever, size "44.27"	M7PE 06 L220	20 x 2
with lever, high construction, size "44.27"	M7APE 06 L32	32
with lever, high construction, size "44.27"	M7APE 06L232	32 x 2
with lever, high construction, size "44.27"	M7APE 06 L40	40
with lever, high construction, size "44.27"	M7APE 06L240	40 x 2

- the lever, due to the vertical closing movement, offers an IP66/IP67 degree of protection (according to EN 60529) when fitted with a complete and coupled connector and used with ILME hoods in die cast aluminum with pegs (without adapter, for further information please contact ILME S.p.A.)
- 3.000 hours in salt spray tests (EN ISO 9227) for bulkhead enclosures with V-TYPE lever and hood with moulded pegs (low number of mating cycles)
- 2.000 hours in salt spray tests (EN ISO 9227) for surface mounting housings
- temperature limits: -40 °C ... +180 °C on request -60 °C ... +180 °C with silicone gasket (125 °C - 180 °C with RY inserts)

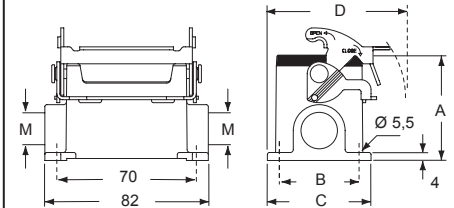
C7IE L



panel cut-out for bulkhead mounting housings



M7PE L - M7APE L



type	A	B	C	D
M7PE 06 L	53	40	52	70
M7APE 06 L	74	45	57	72,5

For bulkhead mounting housings, IP66/IP67 degree of protection is guaranteed for mounting on a sufficiently rigid panel; use suitable length M4 screws (negligible surface buckling when subjected to tightening couple on the fixing screws of 0,8 - 1,2 Nm or deformation caused by the weight of the complete connector).

In case of insufficient rigidity use of C7.. FL counterflanges (page 443) is recommended, in which case use suitable length M4 screws and M4 (on the enclosure) and M4 (on the counterflange) flat/spring washers with M4 locknut.

In addition, the panel surface in contact with the counterflange gasket of the bulkhead mounting housings must be free from defects (deep scratches, grooves, burrs) that could negatively affect the performance of the gasket.

CAUS Type 4/4X/12



MH - MF for aggressive environments E-Xtreme®

inserts		page:
CDD	24 poles + ⊕	76
CDS	9 poles + ⊕	-
CDSH	9 poles + ⊕	86
CDSH NC	6 poles + ⊕	95
CNE	6 poles + ⊕	110
CSE	6 poles + ⊕	-
CSH	6 poles + ⊕	110
CSH S	6 poles + ⊕	122
CCE	6 poles + ⊕	130
CSS	6 poles + ⊕	148
CQE	10 poles + ⊕	168
MIXO	2 modules	262 - 317

hoods with 2 moulded pegs



3.000 HOURS

hoods with 2 moulded pegs



3.000 HOURS

description	part No.		entry	
			M	M
with pegs, side entry	MHOE 06 L20M	20		
with pegs, side entry	MHOE 06 L25M	25		
with pegs, side entry, high construction, without adapter ¹⁾				MFOE 06 L32M 32
with pegs, side entry, high construction, without adapter ¹⁾				MFOE 06 L40M 40
with pegs, top entry ^{2) 3)}	MHVE 06 L20M	20		
with pegs, top entry ²⁾	MHVE 06 L25M	25		
with pegs, top entry, high construction, without adapter ¹⁾				MFVE 06 L32M 32
with pegs, top entry, high construction, without adapter ¹⁾				MFVE 06 L40M 40

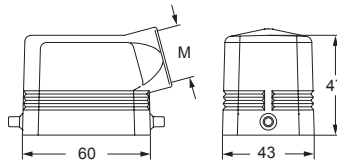
¹⁾ enclosure without adapter, threaded on the body, to be used only with a complete cable gland.

²⁾ cannot be used with MIXO series.

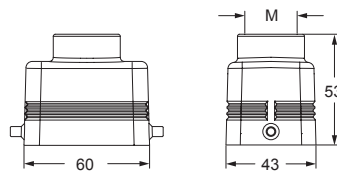
³⁾ can only be used with a complete cable gland (to be purchased separately).

- 3.000 hours in salt spray tests (EN ISO 9227) for bulkhead enclosures with V-TYPE lever and hood with moulded pegs (low number of mating cycles)
- 2.000 hours in salt spray tests (EN ISO 9227) with other E-Xtreme® housings
- temperature limits: -40 °C ... +180 °C on request -60 °C ... +180 °C with silicone gasket (125 °C - 180 °C with RY inserts)
- alternatively, hoods with pegs are coupled with fixed enclosures:
 - C7 E-Xtreme®, IP66/IP67, page 530
 - C-TYPE E-Xtreme®, IP66, page 542

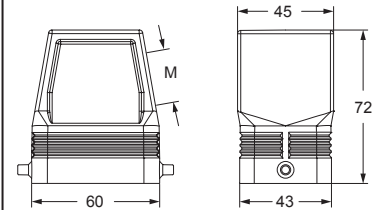
MHOE L..M



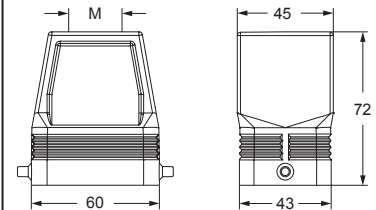
MHVE L..M



MFOE L..M



MFVE L..M



CAVUS® Type 4/4X/12



IP67 if hoods with fused pegs and without adapters coupled with IP67 housings according to the type of lever also IP69 according to IEC/EN 60529

inserts		page:
CDD	42 poles + ⊕	78
CDS	18 poles + ⊕	-
CDSH	18 poles + ⊕	87
CNE	10 poles + ⊕	111
CSE	10 poles + ⊕	-
CSH	10 poles + ⊕	111
CSH S	10 poles + ⊕	123
CCE	10 poles + ⊕	131
CMSH	3+2 (aux) poles + ⊕	136
CMCE	3+2 (aux) poles + ⊕	137
CSS	10 poles + ⊕	149
CT, CTSE (16A) *	10 poles + ⊕	161
CQE	18 poles + ⊕	169
CX	8/24 poles + ⊕	194
MIXO	3 modules	262 - 317

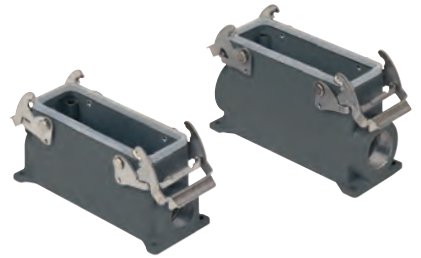
*) can be used only in bulkhead mounting housings

bulkhead mounting housings with 2 levers in stainless steel



3.000 HOURS

surface mounting housings with 2 levers in stainless steel

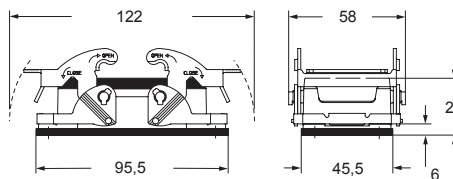


2.000 HOURS

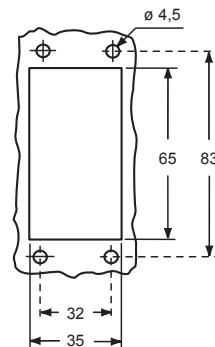
description	part No.	part No.	entry M
with levers and gasket, size "57.27"	C7IE 10		
with levers, size "57.27"		M7PE 10.20	20
with levers, size "57.27"		M7PE 10.220	20 x 2
with levers, high construction, size "57.27"		M7APE 10.32	32
with levers, high construction, size "57.27"		M7APE 10.232	32 x 2
with levers, high construction, size "57.27"		M7APE 10.40	40
with levers, high construction, size "57.27"		M7APE 10.240	40 x 2

- the lever, due to the vertical closing movement, offers an IP66/IP67 degree of protection (according to EN 60529) when fitted with a complete and coupled connector and used with ILME hoods in die cast aluminum with pegs (without adapter, for further information please contact ILME S.p.A.)
- 3.000 hours in salt spray tests (EN ISO 9227) for bulkhead enclosures with V-TYPE lever and hood with moulded pegs (low number of mating cycles)
- 2.000 hours in salt spray tests (EN ISO 9227) for surface mounting housings
- temperature limits: -40 °C ... +180 °C on request -60 °C ... +180 °C with silicone gasket (125 °C - 180 °C with RY inserts)

C7IE

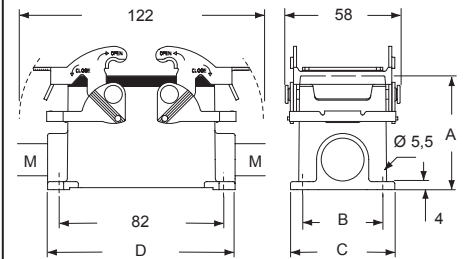


panel cut-out for bulkhead mounting housings



For bulkhead mounting housings, IP66/IP67 degree of protection is guaranteed for mounting on a sufficiently rigid panel; use suitable length M4 screws (negligible surface buckling when subjected to tightening couple on the fixing screws of 0,8 - 1,2 Nm or deformation caused by the weight of the complete connector). In case of insufficient rigidity use of C7.. FL counterflanges (page 443) is recommended, in which case use suitable length M4 screws and M4 (on the enclosure) and M4 (on the counterflange) flat/spring washers with M4 locknut. In addition, the panel surface in contact with the counterflange gasket of the bulkhead mounting housings must be free from defects (deep scratches, grooves, burrs) that could negatively affect the performance of the gasket.

M7PE - M7APE



type	A	B	C	D
M7PE 10	57	40	52	93,5
M7APE 10	74	45	57	94

CAIUS Type 4/4X/12



MH - MF for aggressive environments E-Xtreme®

inserts		page:
CDD	42 poles + ⊕	78
CDS	18 poles + ⊕	-
CDSH	18 poles + ⊕	87
CNE	10 poles + ⊕	111
CSE	10 poles + ⊕	-
CSH	10 poles + ⊕	111
CSH S	10 poles + ⊕	123
CCE	10 poles + ⊕	131
CMSH	3+2 (aux) poles + ⊕	136
CMCE	3+2 (aux) poles + ⊕	137
CSS	10 poles + ⊕	149
CQE	18 poles + ⊕	169
CX	8/24 poles + ⊕	194
MIXO	3 modules	262 - 317

hoods with 4 moulded pegs



3.000 HOURS

hoods with 4 moulded pegs



3.000 HOURS

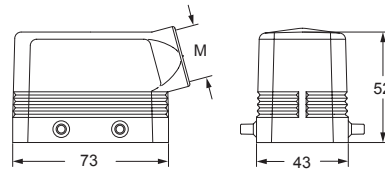
description	part No.	entry		part No.	entry	
			M			M
with pegs, side entry	MHOE 10.20M		20			
with pegs, side entry	MHOE 10.25M		25			
with pegs, side entry, high construction, without adapter ¹⁾				MFOE 10.32M		32
with pegs, side entry, high construction, without adapter ¹⁾				MFOE 10.40M		40
with pegs, top entry ²⁾	MHVE 10.20M		20			
with pegs, top entry	MHVE 10.25M		25			
with pegs, top entry, high construction, without adapter ¹⁾				MFVE 10.32M		32
with pegs, top entry, high construction, without adapter ¹⁾				MFVE 10.40M		40

¹⁾ enclosure without adapter, threaded on the body, to be used only with a complete cable gland.

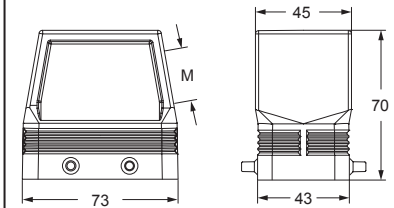
²⁾ can only be used with a complete cable gland (to be purchased separately)

- 3.000 hours in salt spray tests (EN ISO 9227) for bulkhead enclosures with V-TYPE lever and hood with moulded pegs (low number of mating cycles)
- 2.000 hours in salt spray tests (EN ISO 9227) with other E-Xtreme® housings
- temperature limits: -40 °C ... +180 °C on request -60 °C ... +180 °C with silicone gasket (125 °C - 180 °C with RY inserts)
- alternatively, hoods with pegs are coupled with fixed enclosures:
 - C7 E-Xtreme®, IP66/IP67, page 532
 - C-TYPE E-Xtreme®, IP66, page 543

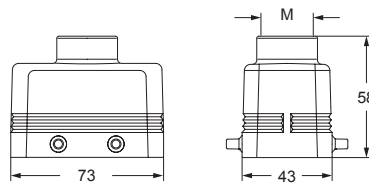
MHOE..M



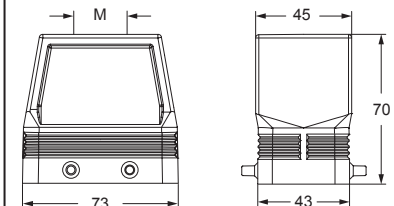
MFOE..M



MHVE..M



MFVE..M



CAUS® Type 4/4X/12



IP67 if hoods with fused pegs and without adapters coupled with IP67 housings according to the type of lever also IP69 according to IEC/EN 60529

inserts		page:
CD	40 poles + ⊕	70
CDD	72 poles + ⊕	79
CDS	27 poles + ⊕	-
CDSH	27 poles + ⊕	88
CNE	16 poles + ⊕	112
CSE	16 poles + ⊕	-
CSH	16 poles + ⊕	112
CSH S	16 poles + ⊕	124
CCE	16 poles + ⊕	132
CMSH, CMCE	6+2 (aux) poles + ⊕	138 - 139
CSS	16 poles + ⊕	150
CT, CTS (10A) *)	40 poles + ⊕	156
CT, CTSE (16A) *)	16 poles + ⊕	162
CQE	32 poles + ⊕	170
CQEE	40 poles + ⊕	176
CP	6 poles + ⊕	178
CX	6/12, 6/36 and 12/2 poles + ⊕	197 - 199
CX	4/0 and 4/2 poles + ⊕	200 - 201
MIXO	4 modules	262 - 317

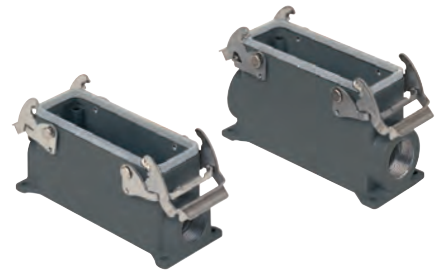
*) can be used only in bulkhead mounting housings

bulkhead mounting housings with 2 levers in stainless steel



3.000 HOURS

surface mounting housings with 2 levers in stainless steel

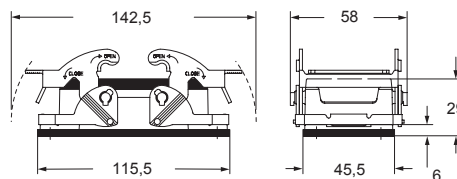


2.000 HOURS

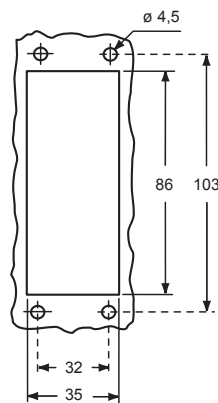
description	part No.	part No.	entry M
with levers and gasket, size "77.27"	C7IE 16		
with levers, size "77.27"		M7PE 16.25	25
with levers, size "77.27"		M7PE 16.225	25 x 2
with levers, high construction, size "77.27"		M7APE 16.32	32
with levers, high construction, size "77.27"		M7APE 16.232	32 x 2
with levers, high construction, size "77.27"		M7APE 16.40	40
with levers, high construction, size "77.27"		M7APE 16.240	40 x 2

- the lever, due to the vertical closing movement, offers an IP66/IP67 degree of protection (according to EN 60529) when fitted with a complete and coupled connector and used with ILME hoods in die cast aluminum with pegs (without adapter, for further information please contact ILME S.p.A.)
- 3.000 hours in salt spray tests (EN ISO 9227) for bulkhead enclosures with V-TYPE lever and hood with moulded pegs (low number of mating cycles)
- 2.000 hours in salt spray tests (EN ISO 9227) for surface mounting housings
- temperature limits: -40 °C ... +180 °C on request -60 °C ... +180 °C with silicone gasket (125 °C - 180 °C with RY inserts)

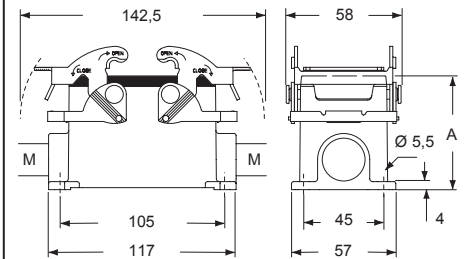
C7IE



panel cut-out for bulkhead mounting housings



M7PE - M7APE



type	A
M7PE 16	63
M7APE 16	81

For bulkhead mounting housings, IP66/IP67 degree of protection is guaranteed for mounting on a sufficiently rigid panel; use suitable length M4 screws (negligible surface buckling when subjected to tightening couple on the fixing screws of 0,8 - 1,2 Nm or deformation caused by the weight of the complete connector). In case of insufficient rigidity use of C7.. FL counterflanges (page 443) is recommended, in which case use suitable length M4 screws and M4 (on the enclosure) and M4 (on the counterflange) flat/spring washers with M4 locknut. In addition, the panel surface in contact with the counterflange gasket of the bulkhead mounting housings must be free from defects (deep scratches, grooves, burrs) that could negatively affect the performance of the gasket.

CAIUS Type 4/4X/12



MH - MF for aggressive environments E-Xtreme®

inserts		page:
CD	40 poles + ⊕	70
CDD	72 poles + ⊕	79
CDS	27 poles + ⊕	-
CDSH	27 poles + ⊕	88
CNE	16 poles + ⊕	112
CSE	16 poles + ⊕	-
CSH	16 poles + ⊕	112
CSH S	16 poles + ⊕	124
CCE	16 poles + ⊕	132
CMSH, CMCE	6+2 (aux) poles + ⊕	138 - 139
CSS	16 poles + ⊕	150
CQE	32 poles + ⊕	170
CQEE	40 poles + ⊕	176
CP	6 poles + ⊕	178
CX	6/12, 6/36 and 12/2 poles + ⊕	197 - 199
CX	4/0 and 4/2 poles + ⊕	200 - 201
MIXO	4 modules	262 - 317

hoods with 4 moulded pegs



3.000 HOURS

hoods with 4 moulded pegs



3.000 HOURS

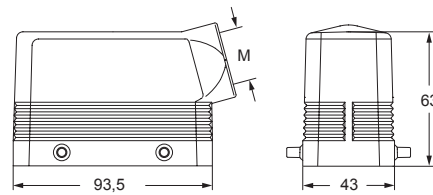
description	part No.		entry	
			M	M
with pegs, side entry	MHOE 16.25M		25	
with pegs, side entry	MHOE 16.32M		32	
with pegs, side entry, high construction, without adapter ¹⁾				MFOE 16.32M 32
with pegs, side entry, high construction, without adapter ¹⁾				MFOE 16.40M 40
with pegs, top entry ²⁾	MHVE 16.25M		25	
with pegs, top entry	MHVE 16.32M		32	
with pegs, top entry, high construction, without adapter ¹⁾				MFVE 16.32M 32
with pegs, top entry, high construction, without adapter ¹⁾				MFVE 16.40M 40

¹⁾ enclosure without adapter, threaded on the body, to be used only with a complete cable gland.

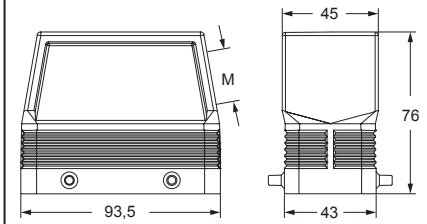
²⁾ can only be used with a complete cable gland (to be purchased separately)

- 3.000 hours in salt spray tests (EN ISO 9227) for bulkhead enclosures with V-TYPE lever and hood with moulded pegs (low number of mating cycles)
- 2.000 hours in salt spray tests (EN ISO 9227) with other E-Xtreme® housings
- temperature limits: -40 °C ... +180 °C on request -60 °C ... +180 °C with silicone gasket (125 °C - 180 °C with RY inserts)
- alternatively, hoods with pegs are coupled with fixed enclosures:
 - C7 E-Xtreme®, IP66/IP67, page 534
 - C-TYPE E-Xtreme®, IP66, page 544

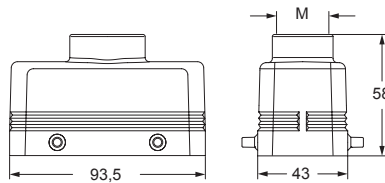
MHOE..M



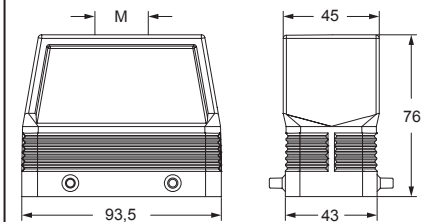
MFOE..M



MHVE..M



MFVE..M



CALUS Type 4/4X/12

IP67 if hoods with fused pegs and without adapters coupled with IP67 housings according to the type of lever also IP69 according to IEC/EN 60529

inserts		page:
CD	64 poles + ⊕	72
CDD	108 poles + ⊕	81
CDS	42 poles + ⊕	-
CDSH	42 poles + ⊕	89
CNE	24 poles + ⊕	113
CSE	24 poles + ⊕	-
CSH	24 poles + ⊕	113
CSH S	24 poles + ⊕	125
CCE	24 poles + ⊕	133
CMSH	10+2 (aux) poles + ⊕	140
CMCE	10+2 (aux) poles + ⊕	141
CSS	24 poles + ⊕	151
CT, CTS (10A) *)	64 poles + ⊕	157
CT, CTSE (16A) *)	24 poles + ⊕	163
CQE	46 poles + ⊕	171
CQEE	64 poles + ⊕	177
CX	4/8 and 6/6 poles + ⊕	204 and 206
MIXO	6 modules	262 - 317

*) can be used only in bulkhead mounting housings

bulkhead mounting housings with 2 levers in stainless steel



3.000 HOURS

surface mounting housings with 2 levers in stainless steel

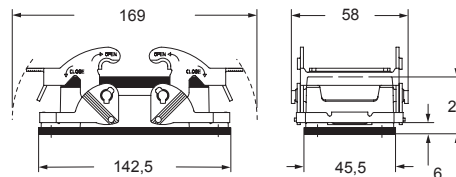


2.000 HOURS

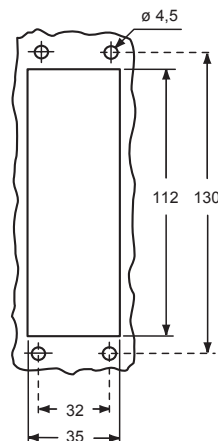
description	part No.	part No.	entry M
with levers and gasket, size "104.27"	C7IE 24		
with levers, size "104.27"		M7PE 24.25	25
with levers, size "104.27"		M7PE 24.225	25 x 2
with levers, high construction, size "104.27"		M7APE 24.32	32
with levers, high construction, size "104.27"		M7APE 24.232	32 x 2
with levers, high construction, size "104.27"		M7APE 24.40	40
with levers, high construction, size "104.27"		M7APE 24.240	40 x 2

- the lever, due to the vertical closing movement, offers an IP66/IP67 degree of protection (according to EN 60529) when fitted with a complete and coupled connector and used with ILME hoods in die cast aluminum with pegs (without adapter, for further information please contact ILME S.p.A.)
- 3.000 hours in salt spray tests (EN ISO 9227) for bulkhead enclosures with V-TYPE lever and hood with moulded pegs (low number of mating cycles)
- 2.000 hours in salt spray tests (EN ISO 9227) for surface mounting housings
- temperature limits: -40 °C ... +180 °C on request -60 °C ... +180 °C with silicone gasket (125 °C - 180 °C with RY inserts)

C7IE

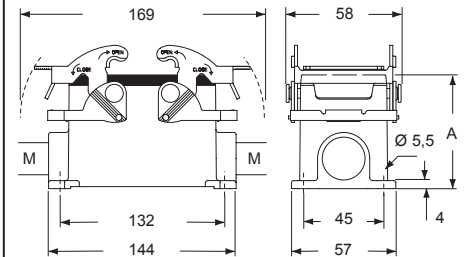


panel cut-out for bulkhead mounting housings



For bulkhead mounting housings, IP66/IP67 degree of protection is guaranteed for mounting on a sufficiently rigid panel; use suitable length M4 screws (negligible surface buckling when subjected to tightening couple on the fixing screws of 0,8 - 1,2 Nm or deformation caused by the weight of the complete connector). In case of insufficient rigidity use of C7.. FL counterflanges (page 443) is recommended, in which case use suitable length M4 screws and M4 (on the enclosure) and M4 (on the counterflange) flat/spring washers with M4 locknut. In addition, the panel surface in contact with the counterflange gasket of the bulkhead mounting housings must be free from defects (deep scratches, grooves, burrs) that could negatively affect the performance of the gasket.

M7PE - M7APE



type	A
M7PE 24	63
M7APE 24	81

CAIUS Type 4/4X/12



MH - MF for aggressive environments E-Xtreme®

inserts		page:
CD	64 poles + ⊕	72
CDD	108 poles + ⊕	81
CDS	42 poles + ⊕	-
CDSH	42 poles + ⊕	89
CNE	24 poles + ⊕	113
CSE	24 poles + ⊕	-
CSH	24 poles + ⊕	113
CSH S	24 poles + ⊕	125
CCE	24 poles + ⊕	133
CMSH	10+2 (aux) poles + ⊕	140
CMCE	10+2 (aux) poles + ⊕	141
CSS	24 poles + ⊕	151
CQE	46 poles + ⊕	171
CQEE	64 poles + ⊕	177
CX	4/8 and 6/6 poles + ⊕	204 and 206
MIXO	6 modules	262 - 317

hoods with 4 moulded pegs



3.000 HOURS

hoods with 4 moulded pegs



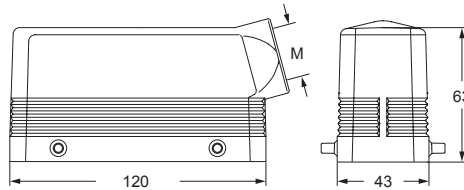
3.000 HOURS

description	part No.	entry	part No.	entry
		M		
with pegs, side entry	MHOE 24.25M	25		
with pegs, side entry	MHOE 24.32M	32		
with pegs, side entry, high construction, without adapter ¹⁾			MFOE 24.32M	32
with pegs, side entry, high construction, without adapter ¹⁾			MFOE 24.40M	40
with pegs, top entry ²⁾	MHVE 24.25M	25		
with pegs, top entry	MHVE 24.32M	32		
with pegs, top entry	MHVE 24.40M	40		
with pegs, top entry, high construction, without adapter ¹⁾			MFVE 24.32M	32
with pegs, top entry, high construction, without adapter ¹⁾			MFVE 24.40M	40

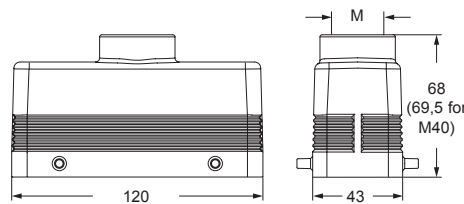
- 1) enclosure without adapter, threaded on the body, to be used only with a complete cable gland.
- 2) can only be used with a complete cable gland (to be purchased separately)

- 3.000 hours in salt spray tests (EN ISO 9227) for bulkhead enclosures with V-TYPE lever and hood with moulded pegs (low number of mating cycles)
- 2.000 hours in salt spray tests (EN ISO 9227) with other E-Xtreme® housings
- temperature limits: -40 °C ... +180 °C on request -60 °C ... +180 °C with silicone gasket (125 °C - 180 °C with RY inserts)
- alternatively, hoods with pegs are coupled with fixed enclosures:
- C7 E-Xtreme®, IP66/IP67, page 536
- C-TYPE E-Xtreme®, IP66, page 545

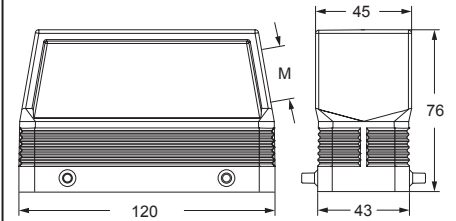
MHOE..M



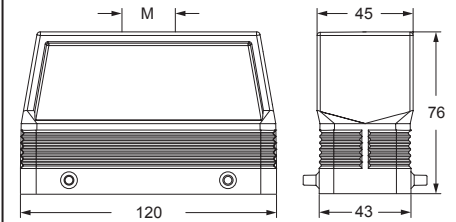
MHVE..M



MFOE..M



MFVE..M



CALUS® Type 4/4X/12



IP67 if hoods with fused pegs and without adapters coupled with IP67 housings according to the type of lever also IP69 according to IEC/EN 60529

inserts		page:
CK	3 poles + ⊕	58
CK	4 poles + ⊕	58
CKS	3 poles + ⊕	-
CKS	4 poles + ⊕	-
CKSH	3 poles + ⊕	63
CKSH	4 poles + ⊕	63
CD	8 poles	67
CQ4	2 poles + ⊕	182
CQ4 H	2 poles + ⊕	183
CQ4	3 poles + ⊕	184
CQ	5 poles + ⊕	186
CQ	7 poles + ⊕	187
CQ	12 poles + ⊕	189
CQ	21 poles	190

bulkhead mounting housings straight and angled



2.000 HOURS

hoods



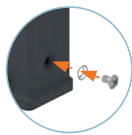
2.000 HOURS

description	part No.	part No. (entry M20)	part No.	part No. (entry M20)
with stainless steel lever and gasket	CKAXE 03 I			
without cable entry, with stainless steel lever and gasket ¹⁾	CKAXE 03 IA			
with cable entry, with stainless steel lever and gasket ¹⁾		MKAXE IAP20		
with cable entry, with stainless steel lever and gasket bulkhead hole closed ¹⁾		MKAXE AP20		
with pegs, top entry ¹⁾			MKAE V20	
angled, with pegs, side entry ¹⁾			MKAE VA20	
with stainless steel lever, top entry ¹⁾			MKAXE VG20	
gasket and screw kit for IP66/IP67/IP69 ²⁾ for CK, CKSH, CQ4, CQ 05, inserts	CKR 65		CKR 65	
gasket and screw kit for IP66/IP67/IP69 ²⁾ for CD 08 inserts	CKR 65 D		CKR 65 D	

¹⁾ Not suitable for CQ4 series inserts

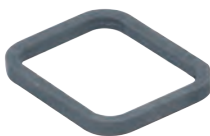
²⁾ To obtain the IP66/IP67/IP69 degree of protection it is necessary to replace the fixing screw supplied with all inserts, with the one with gasket included in the kit (to be purchased separately) **except for** the inserts listed below (already supplied with a fixing screw with gasket):
- CQF/M 07, CQF/M 12

NOTE: The enclosure shown here is an example. The screw and sealing gasket kit can be used with all enclosures' part nos. in this page



- 2.000 hours in salt spray tests (EN ISO 9227)
- temperature limits: -40 °C ... +125 °C

CR 03 W
FKM optional gasket for male inserts (to replace the gasket already provided with the insert)

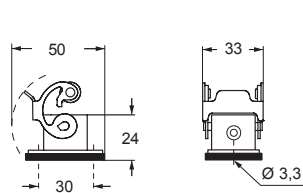


CAIUS®
Type 12
Type 4/4X only
with CKR 65 (D)

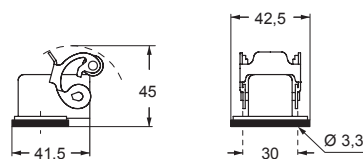


IP66/IP67/IP69 with CKR 65 (D) ²⁾

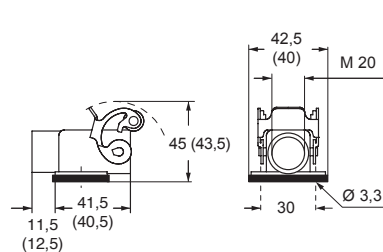
CKAXE I



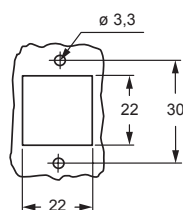
CKAXE IA



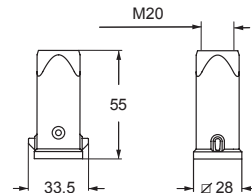
MKAXE IAP (MKAXE AP)



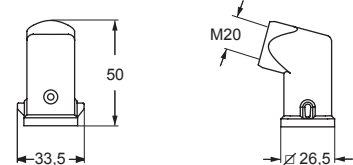
panel cut-out for bulkhead mounting housings



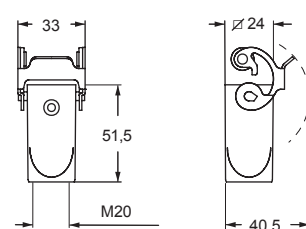
MKAE V



MKAE VA



MKAXE VG



CK and MKA for aggressive environments E-Xtreme®

inserts		page:
CK	3 poles + ⊕	58
CK	4 poles + ⊕	58
CKS	3 poles + ⊕	-
CKS	4 poles + ⊕	-
CKSH	3 poles + ⊕	63
CKSH	4 poles + ⊕	63
CD	8 poles	67
CQ	5 poles + ⊕	186
CQ	7 poles + ⊕	187
CQ	12 poles + ⊕	189
CQ	21 poles	190

angled bulkhead mounting housings



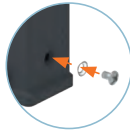
2.000 HOURS

description	part No. (entry M20 / M25)
stainless steel lever, M20 fixing thread (*) 1)	MKAXE IAF20
stainless steel lever, M25 fixing thread (*) 1)	MKAXE IAF25
gasket and screw kit for IP66/IP67/IP69 1) for CK, CKSH, CQ4, CQ 05, inserts	CKR 65
gasket and screw kit for IP66/IP67/IP69 1) for CD 07/08 inserts	CKR 65 D

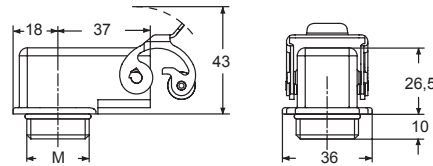
(*) locknut supplied on request, see catalogue cable glands (articles AS M20N and AS M25N metallic, AS M20L and AS M25L insulating).

1) To obtain the IP66/IP67/IP69 degree of protection it is necessary to replace the fixing screw supplied with all inserts, with the one with gasket included in the kit (to be purchased separately) **except for** the inserts listed below (already supplied with a fixing screw with gasket):
- CQF/M 07, CQF/M 12

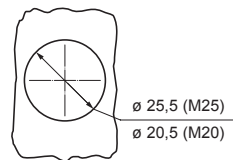
NOTE: The enclosure shown here is an example. The screw and sealing gasket kit can be used with all enclosures' part nos. in this page



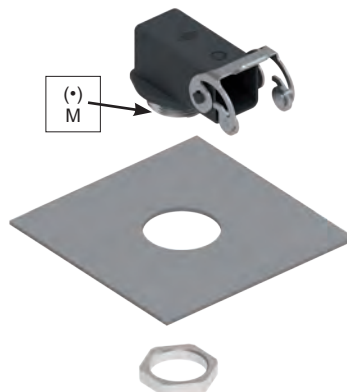
MKAXE IAF



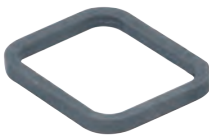
panel cut-out



USE OF THE LOCKNUT



CR 03 W
FKM optional gasket for male inserts (to replace the gasket already provided with the insert)



Type 12
Type 4/4X only
with CKR 65 (D)



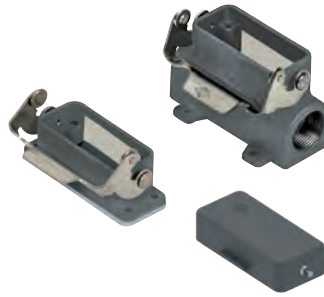
IP44 IP66/IP67/IP69 with CKR 65 (D) 1)

CZ7 - MZ7 and MZ - MZA for aggressive environments E-Xtreme®

inserts		page:
CD	15 poles + ⊕	68
CDA	10 poles + ⊕	98
CSAH	10 poles + ⊕	99
CDC	10 poles + ⊕	104
MIXO	1 module	264 - 316

Covers **cannot be used together** with metal coding pins.

housings with single lever in stainless steel and cover



2.000 HOURS

hoods with riveted locking pegs and cover

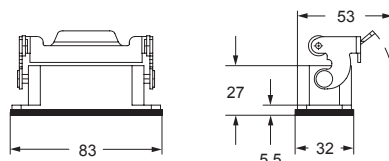


2.000 HOURS

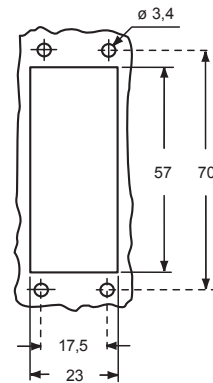
description	part No.	part No	entry M	part No.	entry M
bulkhead mounting housing, with lever	CZ7IE 15 L				
surface mounting housing, with lever		MZ7PE 15L225	25 x 2		
cover with pegs and gasket (for 1 lever enclosures) ¹⁾	CZCE 15 L				
with pegs and gasket, side entry				MZOE 15 L20	20
with pegs and gasket, side entry				MZOE 15 L25	25
with pegs and gasket, side entry, high construction				MZAOE 15 L25	25
with pegs and gasket, top entry				MZVE 15 L20	20
with pegs and gasket, top entry, high construction				MZAVE 15 L25	25
cover with lever (for enclosures with pegs) ²⁾				CZ7CE 15 LG	

- The rigid lever, offers an IP66/IP67/IP69 degree of protection (according to EN 60529) when fitted with a complete and coupled connector and used with ILME standard hoods in die cast aluminum with pegs (without adapter, for further information please contact ILME S.p.A.)
- 2.000 hours in salt spray tests (EN ISO 9227)
- temperature limits: -40 °C ... +125 °C
- mechanical life: ≥ 500 cycles

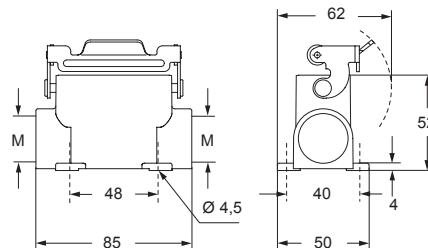
CZ7IE L



panel cut-out for bulkhead mounting housings



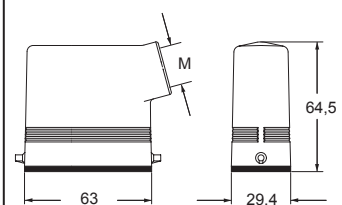
MZ7PE L



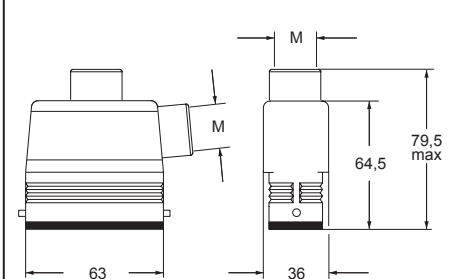
CZCE L



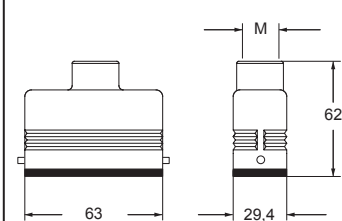
MZOE L



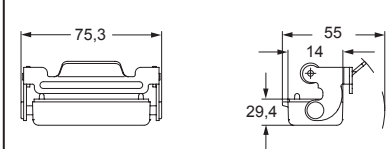
MZAOE L and MZAVE L



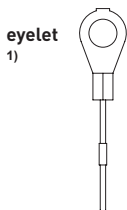
MZVE L



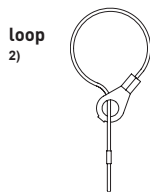
CZ7CE LG



For fixing on housings



For fixing on hoods



CAIUS® Type 4/4X/12

- insulating cable gland or fittings without gasket
- cable gland with O-Ring gasket
- cable gland with O-Ring gasket for housings coupled with either a cover or a hood without adapter ● and for hoods coupled with a cover with lever ●

CZ7 - MZ7 and MZ - MZA for aggressive environments E-Xtreme®

inserts		page:
CD	25 poles + ⊕	69
CDD	38 poles + ⊕	77
CDA	16 poles + ⊕	100
CSAH	16 poles + ⊕	101
CDC	16 poles + ⊕	105

Covers **cannot be used together** with metal coding pins.

housings with single lever in stainless steel and cover



2.000 HOURS

hoods with riveted locking pegs and cover

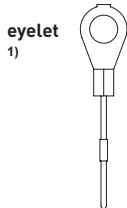


2.000 HOURS

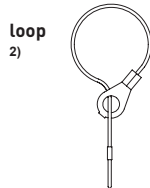
description	part No.	part No	entry M	part No.	entry M
bulkhead mounting housing, with lever	CZ7IE 25 L				
surface mounting housing, with lever		MZ7PE 25L225	25 x 2		
cover with pegs and gasket (for 1 lever enclosures) ¹⁾	CZCE 25 L				
with pegs and gasket, side entry				MZOE 25 L20	20
with pegs and gasket, side entry				MZOE 25 L25	25
with pegs and gasket, side entry, high construction				MZAOE 25 L25	25
with pegs and gasket, top entry ³⁾				MZVE 25 L20	20
with pegs and gasket, top entry, high construction				MZAVE 25 L25	25
cover with lever (for enclosures with pegs) ²⁾				CZ7CE 25 LG	

- ³⁾ can only be used with a complete cable gland (to be purchased separately)
- The rigid lever, offers an IP66/IP67/IP69 degree of protection (according to EN 60529) when fitted with a complete and coupled connector and used with ILME standard hoods in die cast aluminum with pegs (without adapter, for further information please contact ILME S.p.A.)
 - 2.000 hours in salt spray tests (EN ISO 9227: 2012)
 - temperature limits: -40 °C ... +125 °C
 - mechanical life: ≥ 500 cycles

For fixing on housings



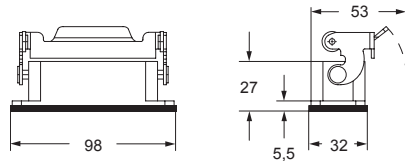
For fixing on hoods



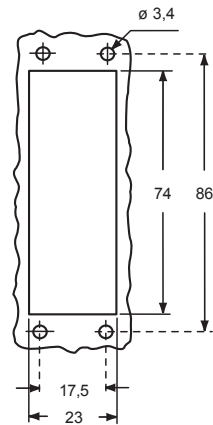
CRUS® Type 4/4X/12

- insulating cable gland or fittings without gasket
- cable gland with O-Ring gasket
- cable gland with O-Ring gasket for housings coupled with either a cover or a hood without adapter ● and for hoods coupled with a cover with lever ●

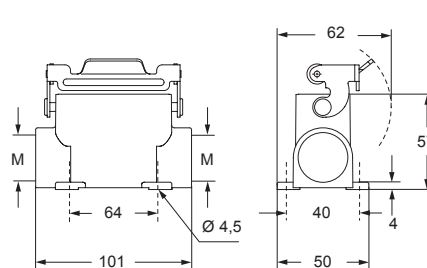
CZ7IE L



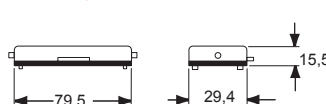
panel cut-out for bulkhead mounting housings



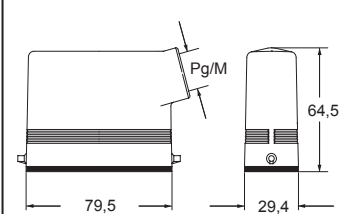
MZ7PE L



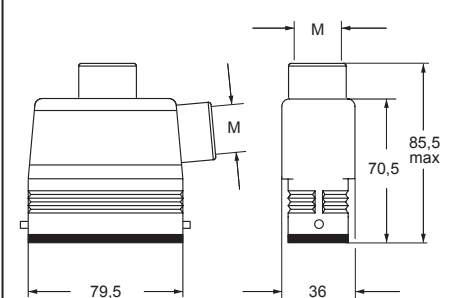
CZCE L ●



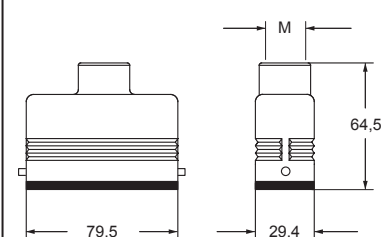
MZOE L ●



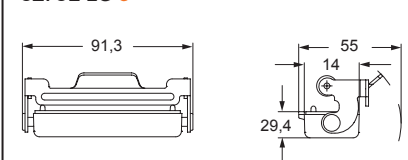
MZAOE L and MZAVE L



MZVE L ³⁾ ●



CZ7CE LG ●



E-Xtreme®

CH and MA for aggressive environments E-Xtreme®

inserts		page:
CDD	24 poles + ⊕	76
CDS	9 poles + ⊕	-
CDSH	9 poles + ⊕	86
CDSH NC	6 poles + ⊕	95
CNE	6 poles + ⊕	110
CSE	6 poles + ⊕	-
CSH	6 poles + ⊕	110
CSH S	6 poles + ⊕	122
CCE	6 poles + ⊕	130
CSS	6 poles + ⊕	148
CT, CTSE (16A) *	6 poles + ⊕	160
CQE	10 poles + ⊕	168
MIXO	2 modules	262 - 317

*) only for enclosure CHIE 06 L

housings with single lever and cover



2.000 HOURS

hoods with riveted locking pegs and cover

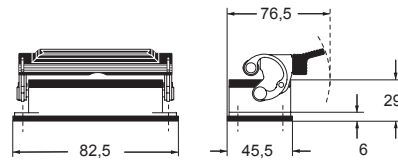


2.000 HOURS

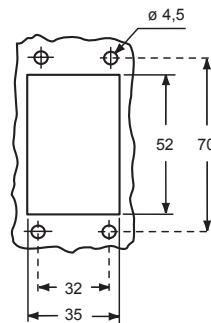
description	part No.	part No	entry M	part No.	entry M
bulkhead mounting housing, with lever and gasket	CHIE 06 L				
surface mounting housing, with lever, high construction		MAPE 06 L32	32		
cover with pegs (for 1 lever enclosures) ¹⁾	CHCE 06 L				
cover with pegs (for 1 lever enclosures) ²⁾	CHCE 06 SL				
with pegs, side entry, high construction				MAOE 06 L32	32
with pegs, top entry, high construction				MAVE 06 L32	32
cover with lever (for enclosures with pegs) ²⁾				CHCE 06 LG	
with lever and gasket, top entry, high construction				MAVE 06 LG32	32

- 2.000 hours in salt spray tests (EN ISO 9227)
- temperature limits: -40 °C ... +125 °C
- mechanical life: ≥ 500 cycles
- alternatively, hoods with pegs are coupled with fixed enclosures:
- C7 E-Xtreme®, IP66/IP67 stainless steel lever, page 530

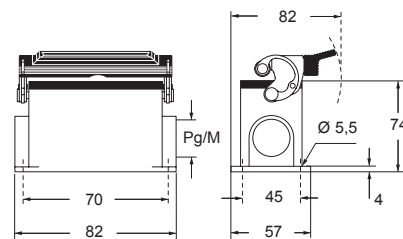
CHIE L



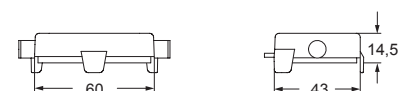
panel cut-out for bulkhead mounting housings



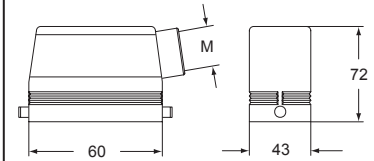
MAPE L



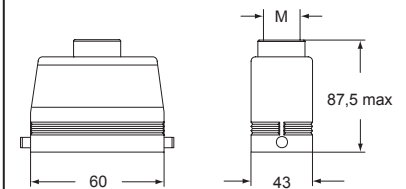
CHCE L - CHCE SL



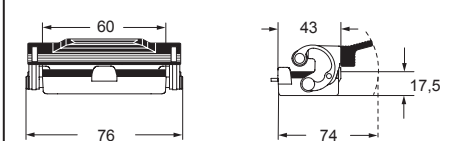
MAOE L



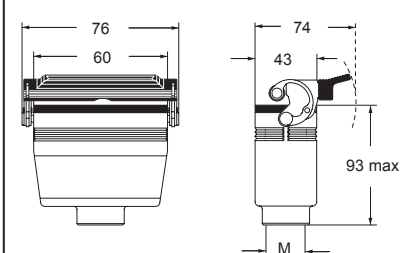
MAVE L



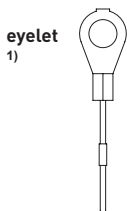
CHCE LG



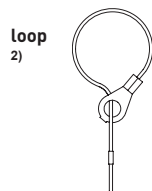
MAVE LG



For fixing on housings



For fixing on hoods



CALUS Type 4/4X/12

insulating cable gland or fittings without gasket

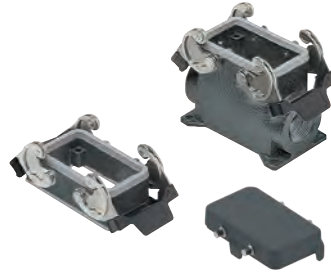
cable gland with O-Ring gasket

CH and MA for aggressive environments E-Xtreme®

inserts		page:
CDD	42 poles + ⊕	78
CDS	18 poles + ⊕	-
CDSH	18 poles + ⊕	87
CNE	10 poles + ⊕	111
CSE	10 poles + ⊕	-
CSH	10 poles + ⊕	111
CSH S	10 poles + ⊕	123
CCE	10 poles + ⊕	131
CMSH	3+2 (aux) poles + ⊕	136
CMCE	3+2 (aux) poles + ⊕	137
CSS	10 poles + ⊕	149
CT, CTSE (16A) *)	10 poles + ⊕	161
CQE	18 poles + ⊕	169
CX	8/24 poles + ⊕	194
MIXO	3 modules	262 - 317

*) only for enclosure CHIE 10

housings with 2 levers and cover



2.000 HOURS

hoods with riveted locking peg and cover

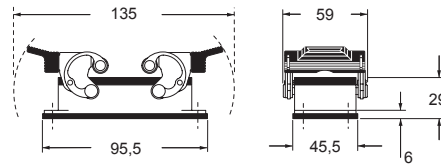


2.000 HOURS

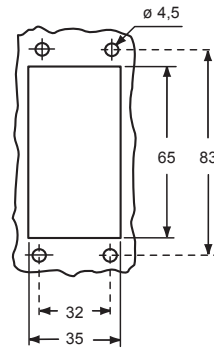
description	part No.	part No	entry M	part No.	entry M
bulkhead mounting housing, with levers and gasket	CHIE 10				
surface mounting housing, with levers, high construction		MAPE 10.32	32		
cover with 4 pegs (for enclosures with 2 levers) ¹⁾	CHCE 10				
cover with 4 pegs (for enclosures with 2 levers) ²⁾	CHCE 10 S				
with pegs, side entry, high construction				MAOE 10.32	32
with pegs, top entry, high construction				MAVE 10.32	32
cover with 2 levers (for enclosures with 4 pegs) ²⁾				CHCE 10 G	
with levers and gasket, top entry, high construction				MAVE 10 G32	32

- 2.000 hours in salt spray tests (EN ISO 9227)
- temperature limits: -40 °C ... +125 °C
- mechanical life: ≥ 500 cycles
- alternatively, hoods with pegs are coupled with fixed enclosures:
- C7 E-Xtreme®, IP66/IP67 stainless steel lever, page 532

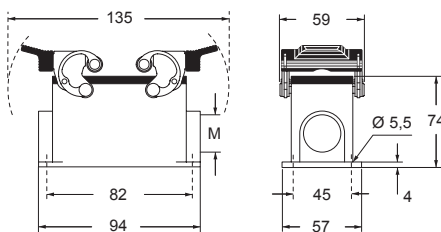
CHIE



panel cut-out for bulkhead mounting housings



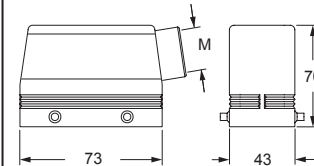
MAPE



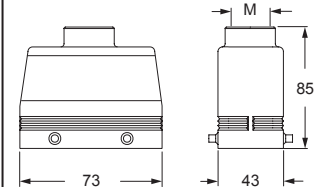
CHCE - CHCE S



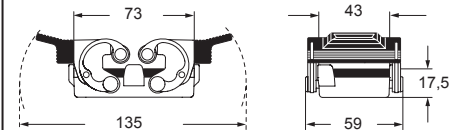
MAOE



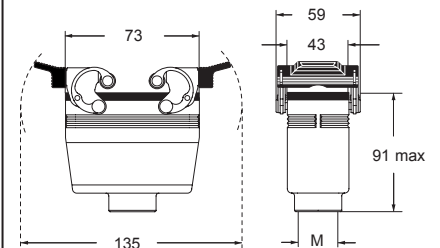
MAVE



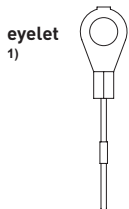
CHCE G



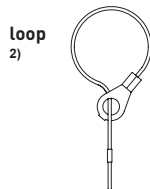
MAVE G



For fixing on housings



For fixing on hoods



CALUS Type 4/4X/12

insulating cable gland or fittings without gasket

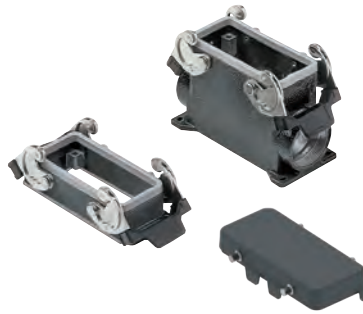
cable gland with O-Ring gasket

CH and MH - MA for aggressive environments E-Xtreme®

inserts		page:
CD	40 poles + ⊕	70
CDD	72 poles + ⊕	79
CDS	27 poles + ⊕	-
CDSH	27 poles + ⊕	88
CNE	16 poles + ⊕	112
CSE	16 poles + ⊕	-
CSH	16 poles + ⊕	112
CSH S	16 poles + ⊕	124
CCE	16 poles + ⊕	132
CMSH, CMCE	6+2 (aux) poles + ⊕	138 - 139
CSS	16 poles + ⊕	150
CT, CTS (10A) *)	40 poles + ⊕	156
CT, CTSE (16A) *)	16 poles + ⊕	162
CQE	32 poles + ⊕	170
CQEE	40 poles + ⊕	176
CP	6 poles + ⊕	178
CX	6/12, 6/36 and 12/2 poles + ⊕	197 - 199
CX	4/0 and 4/2 poles + ⊕	200 - 201
MIXO	4 modules	262 - 317

*) only for enclosure CHIE 16

housings with 2 levers and cover



2.000 HOURS

hoods with riveted locking pegs and cover

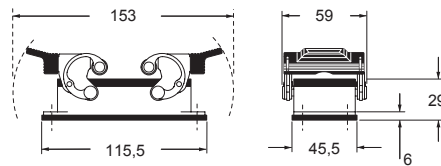


2.000 HOURS

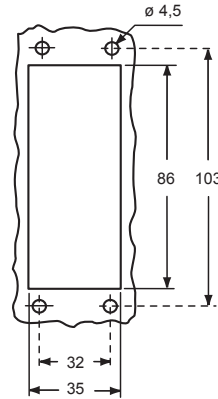
description	part No.	part No	entry M	part No.	entry M
bulkhead mounting housing, with levers and gasket	CHIE 16				
surface mounting housing, with levers, high construction		MAPE 16.32	32		
cover with 4 pegs (for enclosures with 2 levers) 1)	CHCE 16				
cover with 4 pegs (for enclosures with 2 levers) 2)	CHCE 16 S				
with pegs, side entry				MHOE 16.25	25
with pegs, side entry				MHOE 16.32	32
with pegs, side entry, high construction				MAOE 16.32	32
with pegs, side entry, high construction				MAOE 16.40	40
with pegs, top entry				MHVE 16.25	25
with pegs, top entry				MHVE 16.32	32
with pegs, top entry, high construction				MAVE 16.32	32
with pegs, top entry, high construction				MAVE 16.40	40
cover with 2 levers (for enclosures with 4 pegs 2)				CHCE 16 G	
with levers and gasket, top entry, high construction				MAVE 16 G32	32

- 2.000 hours in salt spray tests (EN ISO 9227)
- temperature limits: -40 °C ... +125 °C
- mechanical life: ≥ 500 cycles
- alternatively, hoods with pegs are coupled with fixed enclosures:
- C7 E-Xtreme®, IP66/IP67 stainless steel lever, page 534

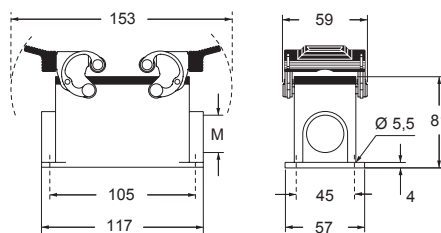
CHIE



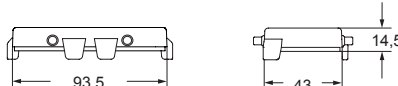
panel cut-out for bulkhead mounting housings



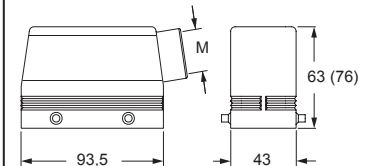
MAPE



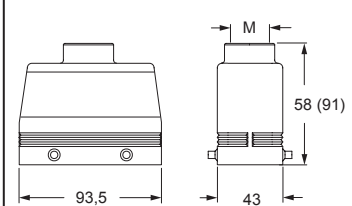
CHCE - CHCE S



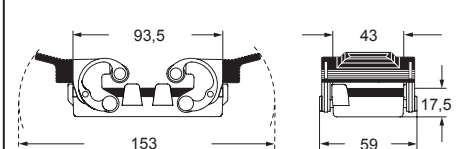
MHOE (MAOE)



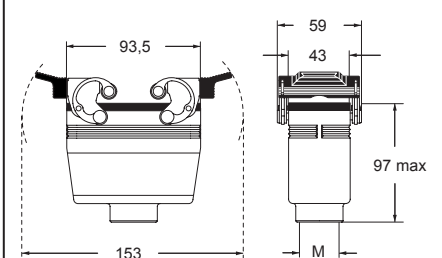
MHVE (MAVE)



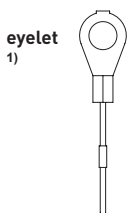
CHCE G



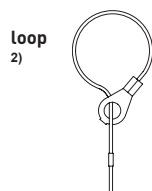
MAVE G



For fixing on housings



For fixing on hoods



CALUS Type 4/4X/12

insulating cable gland or fittings without gasket

cable gland with O-Ring gasket

CH and MH - MA for aggressive environments E-Xtreme®

inserts		page:
CD	64 poles + ⊕	72
CDD	108 poles + ⊕	81
CDS	42 poles + ⊕	-
CDSH	42 poles + ⊕	89
CNE	24 poles + ⊕	113
CSE	24 poles + ⊕	-
CSH	24 poles + ⊕	113
CSH S	24 poles + ⊕	125
CCE	24 poles + ⊕	133
CMSH	10+2 (aux) poles + ⊕	140
CMCE	10+2 (aux) poles + ⊕	141
CSS	24 poles + ⊕	151
CT, CTS (10A *)	64 poles + ⊕	157
CT, CTSE (16A *)	24 poles + ⊕	163
CQE	46 poles + ⊕	171
CQEE	64 poles + ⊕	177
CX	4/8 and 6/6 poles + ⊕	204 and 206
MIXO	6 modules	262 - 317

*) only for enclosure CHIE 24

housings with 2 levers and cover



2.000 HOURS

hoods with riveted locking pegs and cover

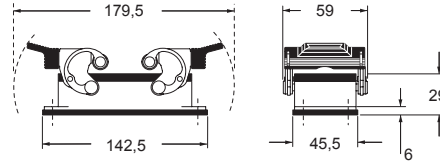


2.000 HOURS

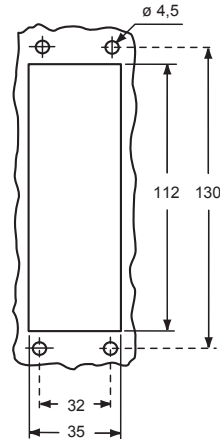
description	part No.	part No	entry M	part No.	entry M
bulkhead mounting housing, with levers and gasket	CHIE 24				
surface mounting housing, with levers, high construction		MAPE 24.32	32		
cover with 4 pegs (for enclosures with 2 levers) ¹⁾	CHCE 24				
cover with 4 pegs (for enclosures with 2 levers) ²⁾	CHCE 24 S				
with pegs, side entry				MHOE 24.25	25
with pegs, side entry				MHOE 24.32	32
with pegs, side entry, high construction				MAOE 24.32	32
with pegs, side entry, high construction				MAOE 24.40	40
with pegs, top entry				MHVE 24.25	25
with pegs, top entry				MHVE 24.32	32
with pegs, top entry, high construction				MAVE 24.32	32
with pegs, top entry, high construction				MAVE 24.40	40
cover with 2 levers (for enclosures with 4 pegs) ²⁾				CHCE 24 G	
with levers and gasket, top entry, high construction				MAVE 24 G32	32

- 2.000 hours in salt spray tests (EN ISO 9227)
- temperature limits: -40 °C ... +125 °C
- mechanical life: ≥ 500 cycles
- alternatively, hoods with pegs are coupled with fixed enclosures:
- C7 E-Xtreme®, IP66/IP67 stainless steel lever, page 536

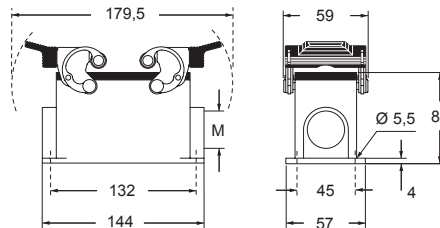
CHIE



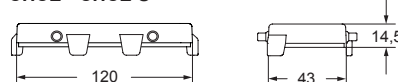
panel cut-out for bulkhead mounting housings



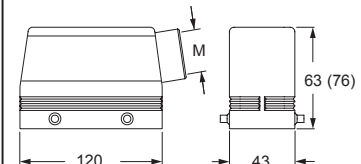
MAPE



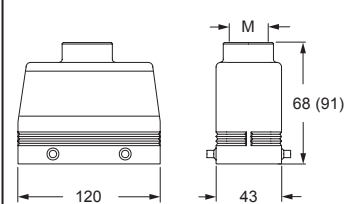
CHCE - CHCE S



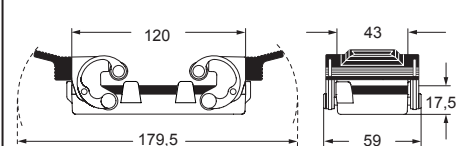
MHOE (MAOE)



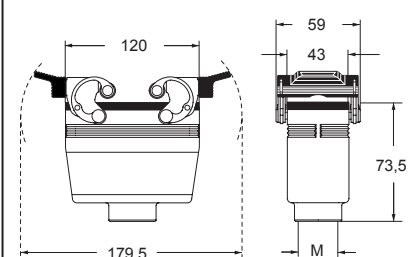
MHVE (MAVE)



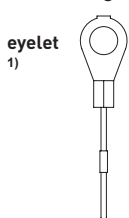
CHCE G



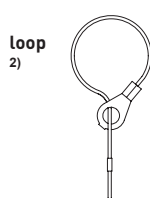
MAVE G



For fixing on housings



For fixing on hoods



CALUS Type 4/4X/12



insulating cable gland or fittings without gasket



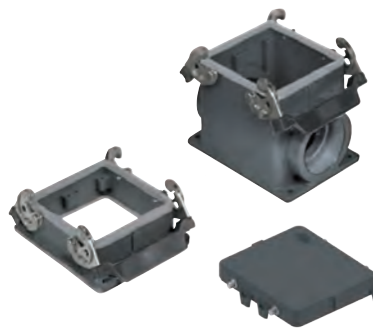
cable gland with O-Ring gasket

inserts		page:
CD	80 poles + ⊕	73
CDD	144 poles + ⊕	82
CDS	54 poles + ⊕	-
CDSH	54 poles + ⊕	90
CNE	32 poles + ⊕	114
CSE	32 poles + ⊕	-
CSH	32 poles + ⊕	114
CSH S	32 poles + ⊕	126
CCE	32 poles + ⊕	134
CSS	32 poles + ⊕	152
CTSE (16A) *	32 poles + ⊕	164
CQE	64 poles + ⊕	172
CME	12+4 (aux) poles + ⊕	142
CMSH	12+4 (aux) poles + ⊕	142
CMCE	12+4 (aux) poles + ⊕	143
CP	12 poles + ⊕	179
MIXO	4 + 4 modules	262 - 317

*) only for enclosure CHIE 32

insert dimensions:
2 x (77,5 x 27) mm

housings with 2 levers and cover



2.000 HOURS

hoods with riveted locking pegs and cover

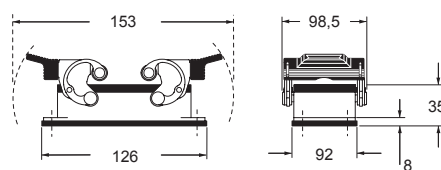


2.000 HOURS

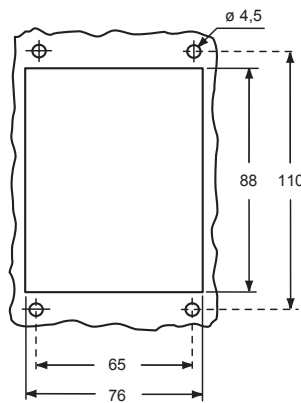
description	part No.	part No	entry M	part No.	entry M
bulkhead mounting housing, with levers and gasket	CHIE 32				
surface mounting housing, with levers, high construction		MHPE 32.50	50		
cover with 4 pegs (for enclosures with 2 levers) 1)	CHCE 32				
cover with 4 pegs (for enclosures with 2 levers) 2)	CHCE 32 S				
with pegs, side entry				MHOE 32.40	40
with pegs, top entry				MHVE 32.40	40
cover with 2 levers (for enclosures with 4 pegs) 2)				CHCE 32 G	
with levers and gasket, top entry				MHVE 32 G40	40

- 2.000 hours in salt spray tests (EN ISO 9227)
- temperature limits: -40 °C ... +125 °C
- mechanical life: ≥ 500 cycles

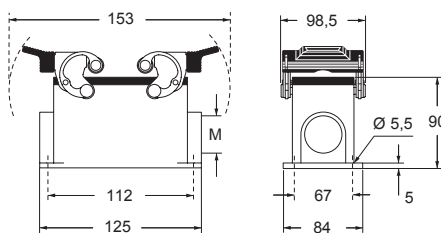
CHIE



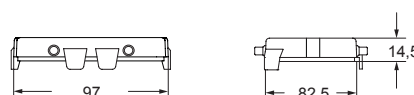
panel cut-out for bulkhead mounting housings



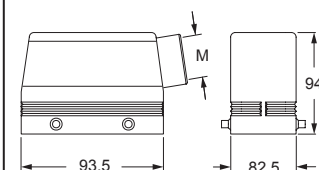
MHPE



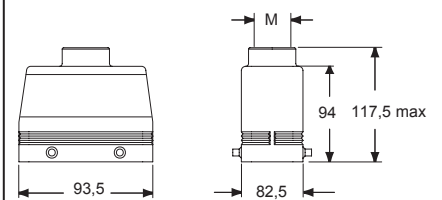
CHCE - CHCE S



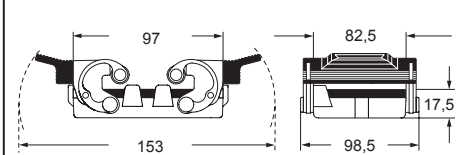
MHOE



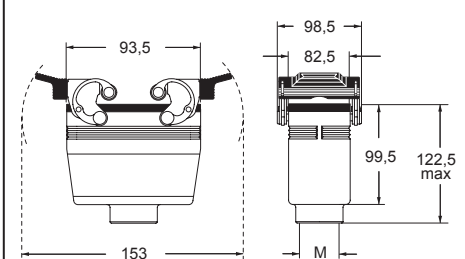
MHVE



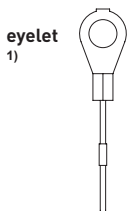
CHCE G



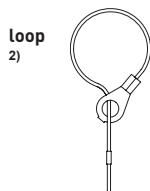
MHVE G



For fixing on housings



For fixing on hoods



CALUS Type 4/4X/12

insulating cable gland or fittings without gasket

cable gland with O-Ring gasket

CH and MH for aggressive environments E-Xtreme®

inserts		page:
CD	128 poles + ⊕	74
CDD	216 poles + ⊕	83
CDS	84 poles + ⊕	-
CDSH	84 poles + ⊕	91
CNE	48 poles + ⊕	115
CSE	48 poles + ⊕	-
CSH	48 poles + ⊕	115
CSH S	48 poles + ⊕	127
CCE	48 poles + ⊕	135
CME	20+4 (aux) poles + ⊕	144
CMSH	20+4 (aux) poles + ⊕	144
CSS	48 poles + ⊕	153
CTSE (16A) *	48 poles + ⊕	165
CQE	92 poles + ⊕	173
MIXO	6 + 6 modules	262 - 317

*) only for enclosure CHIE 48 LS

insert dimensions:
2 x (104 x 27) mm

description	part No.	part No	entry M	part No.	entry M
-------------	----------	---------	---------	----------	---------

bulkhead mounting housings, with lever, gasket and cover	CHIE 48 LS				
surface mounting housings, with lever and cover		MHPE 48 LS40	40 x 2		
with pegs, side entry				MHOE 48 L40	40
with pegs, top entry				MHVE 48 L40	40

- 2.000 hours in salt spray tests (EN ISO 9227)
- temperature limits: -40 °C ... +125 °C
- mechanical life: ≥ 500 cycles

housings with single lever



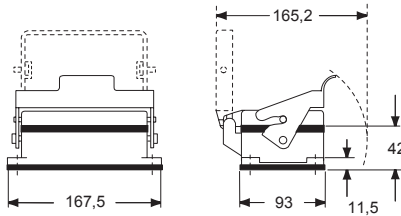
2.000 HOURS

hoods with riveted locking pegs

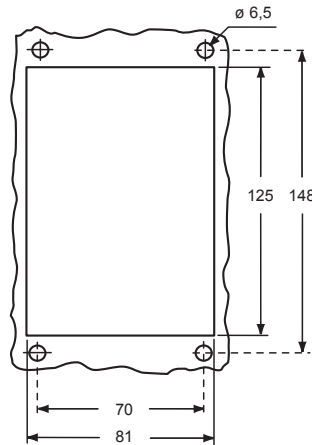


2.000 HOURS

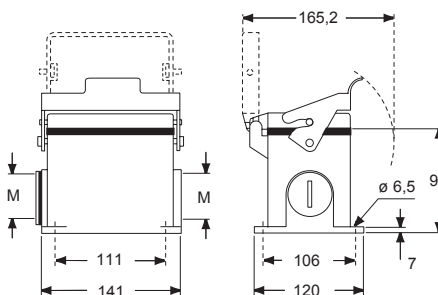
CHIE LS



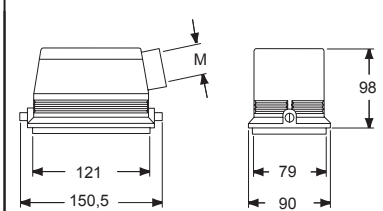
panel cut-out for bulkhead mounting housings



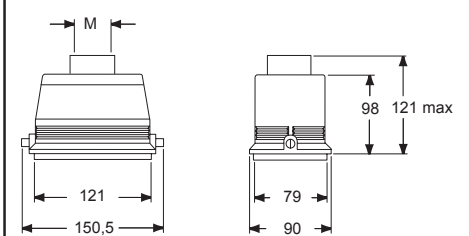
MHPE LS



MHOE L



MHVE L



CALUS Type 4/4X/12

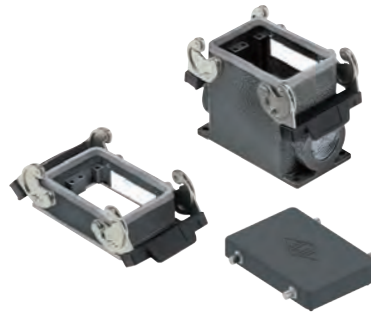
- insulating cable gland or fittings without gasket
- cable gland with O-Ring gasket

inserts		page:
CD	50 poles + ⊕	71
CDD	76 poles + ⊕	80
CDA	32 poles + ⊕	102
CSAH	32 poles + ⊕	103
CDC	32 poles + ⊕	106

insert dimensions:
2 x (66 x 16) mm

Covers **cannot be used together** with metal coding pins.

housings with 2 levers and cover



🕒 **2.000 HOURS**

hoods with riveted locking pegs and cover

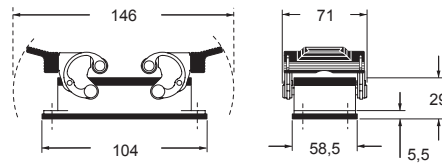


🕒 **2.000 HOURS**

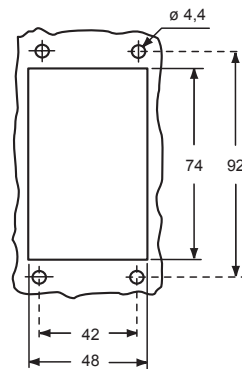
description	part No.	part No	entry M	part No.	entry M
bulkhead mounting housings, with levers and gasket	CHIE 50				
bulkhead mounting housings, with levers		MHPE 50.32	32		
surface mounting housing, with levers		MHPE 50.240	40 x 2		
cover with 4 pegs (for housings with 2 levers) ¹⁾	CHCE 50				
cover with 4 pegs (for housings with 2 levers) ²⁾	CHCE 50 S				
with pegs, side entry				MHOE 50.25	25
with pegs, side entry				MHOE 50.32	32
with pegs, side entry, high construction				MAOE 50.32	32
with pegs, top entry, high construction				MAVE 50.32	32
cover with 2 levers (for enclosures with 4 pegs) ²⁾				CHCE 50 G	

- 2.000 hours in salt spray tests (EN ISO 9227)
- temperature limits: -40 °C ... +125 °C
- mechanical life: ≥ 500 cycles

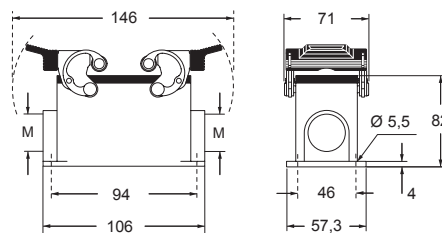
CHIE



panel cut-out for bulkhead mounting housings



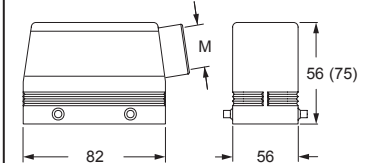
MHPE



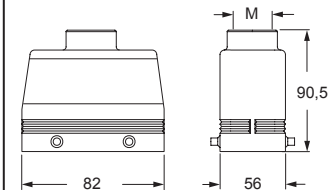
CHCE - CHCE S



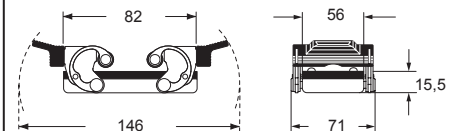
MHOE (MAOE)



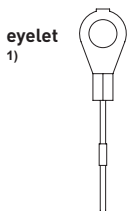
MAVE



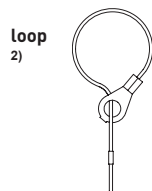
CHCE G



For fixing on housings



For fixing on hoods



CALUS Type 4/4X/12

EN 60529 IP65 insulating cable gland or fittings without gasket

EN 60529 IP66 IP67 IP69 cable gland with O-Ring gasket



CG and MG high protection IP68 version E-Xtreme®

inserts		page:
CDD	24 poles + ⊕	76
CDS	9 poles + ⊕	-
CDSH	9 poles + ⊕	86
CDSH NC	6 poles + ⊕	95
CNE	6 poles + ⊕	110
CSE	6 poles + ⊕	-
CSH	6 poles + ⊕	110
CSH S	6 poles + ⊕	122
CCE	6 poles + ⊕	130
CSS	6 poles + ⊕	148
CQE	10 poles + ⊕	168
MIXO	2 modules	262 - 317

bulkhead mounting housings screw locking



3.000 HOURS

surface mounting housings screw locking



3.000 HOURS

description	part No.	part No.	entry M
-------------	----------	----------	---------

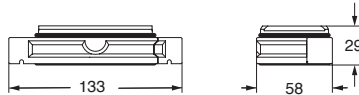
with gasket, size "44.27"
size "44.27"

CGIE 06

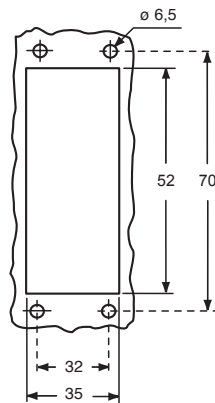
MGPE 06.32 32

- 3.000 hours in salt spray tests (EN ISO 9227)
- temperature limits: -40 °C ... +180 °C
on request -60 °C ... +180 °C with silicone gasket
(>125 °C up to 180 °C with RY inserts)

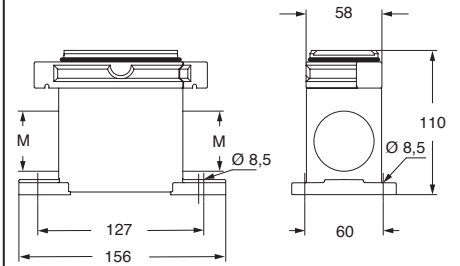
CGIE



panel cut-out for bulkhead mounting housings



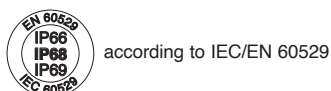
MGPE



CGCP FX
Dust protection
cover
(from page 697)



CAIUS® Type
4/4X/12



CG and MG high protection IP68 version E-Xtreme®

inserts		page:
CDD	24 poles + ⊕	76
CDS	9 poles + ⊕	-
CDSH	9 poles + ⊕	86
CDSH NC	6 poles + ⊕	95
CNE	6 poles + ⊕	110
CSE	6 poles + ⊕	-
CSH	6 poles + ⊕	110
CSH S	6 poles + ⊕	122
CCE	6 poles + ⊕	130
CSS	6 poles + ⊕	148
CQE	10 poles + ⊕	168
MIXO	2 modules	262 - 317

hoods, screw locking



3.000 HOURS

covers, screw locking

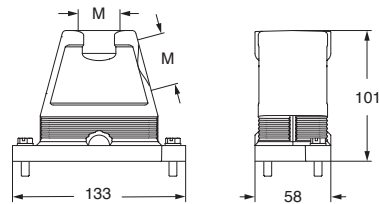


3.000 HOURS

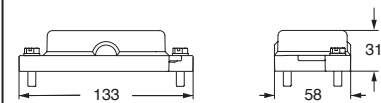
description	part No.	entry M	part No.
with side entry size "44.27"	MGOE 06.25	25	
size "44.27"	MGOE 06.32	32	
with top entry size "44.27"	MGVE 06.25	25	
size "44.27"	MGVE 06.32	32	
size "44.27"	MGVE 06.40	40	
			CGCE 06

- 3.000 hours in salt spray tests (EN ISO 9227)
- temperature limits: -40 °C ... +180 °C
on request -60 °C ... +180 °C with silicone gasket
(>125 °C up to 180 °C with RY inserts)

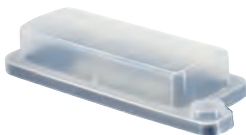
MGOE and MGVE



CGCE



CGCP MB
Dust protection
cover
(from page 697)



CAUS® Type
4/4X/12

according to IEC/EN 60529

CG and MG high protection IP68 version E-Xtreme®

inserts		page:
CDD	42 poles + ⊕	78
CDS	18 poles + ⊕	-
CDSH	18 poles + ⊕	87
CNE	10 poles + ⊕	111
CSE	10 poles + ⊕	-
CSH	10 poles + ⊕	111
CSH S	10 poles + ⊕	123
CCE	10 poles + ⊕	131
CMSH	3+2 (aux) poles + ⊕	136
CMCE	3+2 (aux) poles + ⊕	137
CSS	10 poles + ⊕	149
CQE	18 poles + ⊕	169
CX	8/24 poles + ⊕	194
MIXO	3 modules	262 - 317

bulkhead mounting housings screw locking



3.000 HOURS

surface mounting housings screw locking



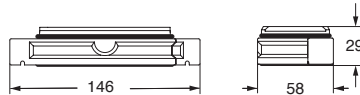
3.000 HOURS

description	part No.	part No.	entry
with gasket, size "57.27"	CGIE 10	MGPE 10.32	32
size "57.27"			

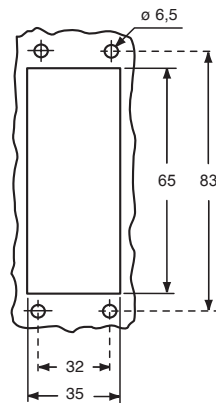
with gasket, size "57.27"
size "57.27"

- 3.000 hours in salt spray tests (EN ISO 9227)
- temperature limits: -40 °C ... +180 °C
- on request -60 °C ... +180 °C with silicone gasket
- (>125 °C up to 180 °C with RY inserts)

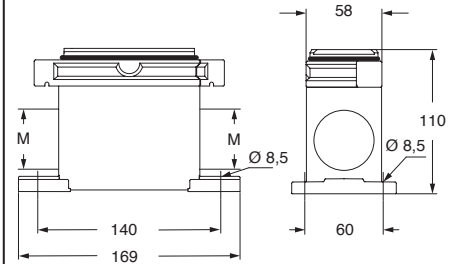
CGIE



panel cut-out for bulkhead mounting housings



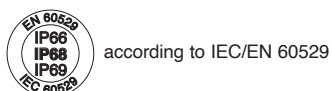
MGPE



CGCP FX
Dust protection
cover
(from page 697)



CAIUS® Type
4/4X/12



CG and MG high protection IP68 version E-Xtreme®

inserts		page:
CDD	42 poles + ⊕	78
CDS	18 poles + ⊕	-
CDSH	18 poles + ⊕	87
CNE	10 poles + ⊕	111
CSE	10 poles + ⊕	-
CSH	10 poles + ⊕	111
CSH S	10 poles + ⊕	123
CCE	10 poles + ⊕	131
CMSH	3+2 (aux) poles + ⊕	136
CMCE	3+2 (aux) poles + ⊕	137
CSS	10 poles + ⊕	149
CQE	18 poles + ⊕	169
CX	8/24 poles + ⊕	194
MIXO	3 modules	262 - 317

hoods, screw locking



3.000 HOURS

covers, screw locking

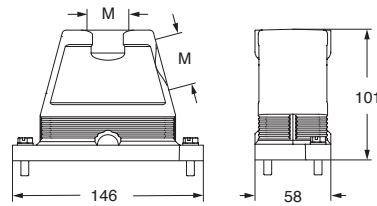


3.000 HOURS

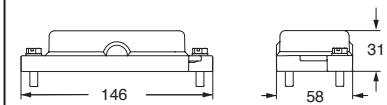
description	part No.	entry M	part No.
with side entry size "57.27"	MGOE 10.25	25	
size "57.27"	MGOE 10.32	32	
with top entry size "57.27"	MGVE 10.25	25	
size "57.27"	MGVE 10.32	32	
size "57.27"	MGVE 10.40	40	
			CGCE 10

- 3.000 hours in salt spray tests (EN ISO 9227)
- temperature limits: -40 °C ... +180 °C
on request -60 °C ... +180 °C with silicone gasket
(>125 °C up to 180 °C with RY inserts)

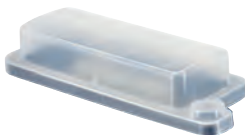
MGOE and MGVE



CGCE



CGCP MB
Dust protection cover
(from page 697)



CAUS® Type 4/4X/12

according to IEC/EN 60529

CG and MG high protection IP68 version E-Xtreme®

inserts		page:
CD	40 poles + ⊕	70
CDD	72 poles + ⊕	79
CDS	27 poles + ⊕	-
CDSH	27 poles + ⊕	88
CNE	16 poles + ⊕	112
CSE	16 poles + ⊕	-
CSH	16 poles + ⊕	112
CSH S	16 poles + ⊕	124
CCE	16 poles + ⊕	132
CMSH, CMCE	6+2 (aux) poles + ⊕	138 - 139
CSS	16 poles + ⊕	150
CQE	32 poles + ⊕	170
CQEE	40 poles + ⊕	176
CP	6 poles + ⊕	178
CX	6/12, 6/36 and 12/2 poles + ⊕	197 - 199
CX	4/0 and 4/2 poles + ⊕	200 - 201
MIXO	4 modules	262 - 317

**bulkhead mounting housings
screw locking**



3.000 HOURS

**surface mounting housings
screw locking**



3.000 HOURS

description	part No.	part No.	entry
			M

with gasket, size "77.27"

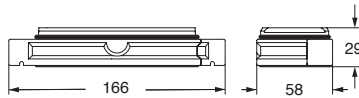
CGIE 16

size "77.27"

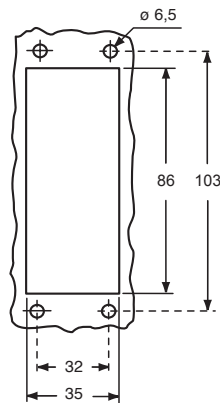
MGPE 16.40 40

- 3.000 hours in salt spray tests (EN ISO 9227)
- temperature limits: -40 °C ... +180 °C
- on request -60 °C ... +180 °C with silicone gasket
- (>125 °C up to 180 °C with RY inserts)

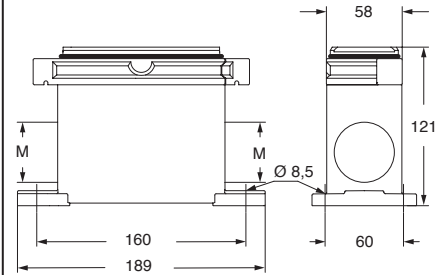
CGIE



panel cut-out for bulkhead mounting housings



MGPE



CGCP FX
Dust protection
cover
(from page 697)



CAIUS® Type
4/4X/12



according to IEC/EN 60529

CG and MG high protection IP68 version E-Xtreme®

inserts		page:
CD	40 poles + ⊕	70
CDD	72 poles + ⊕	79
CDS	27 poles + ⊕	-
CDSH	27 poles + ⊕	88
CNE	16 poles + ⊕	112
CSE	16 poles + ⊕	-
CSH	16 poles + ⊕	112
CSH S	16 poles + ⊕	124
CCE	16 poles + ⊕	132
CMSH, CMCE	6+2 (aux) poles + ⊕	138 - 139
CSS	16 poles + ⊕	150
CQE	32 poles + ⊕	170
CQEE	40 poles + ⊕	176
CP	6 poles + ⊕	178
CX	6/12, 6/36 and 12/2 poles + ⊕	197 - 199
CX	4/0 and 4/2 poles + ⊕	200 - 201
MIXO	4 modules	262 - 317

hoods, screw locking



3.000 HOURS

covers, screw locking

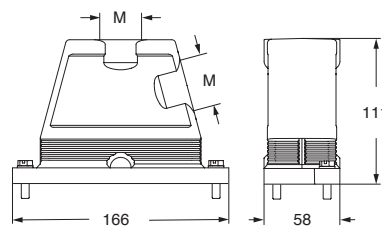


3.000 HOURS

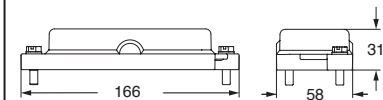
description	part No.	entry M	part No.
with side entry			
size "77.27"	MGOE 16.32	32	
size "77.27"	MGOE 16.40	40	
size "77.27"	MGOE 16.50	50	
with top entry			
size "77.27"	MGVE 16.25	25	
size "77.27"	MGVE 16.225	25 x 2	
size "77.27"	MGVE 16.32	32	
size "77.27"	MGVE 16.40	40	
size "77.27"	MGVE 16.50	50	
size "77.27"			CGCE 16

- 3.000 hours in salt spray tests (EN ISO 9227)
- temperature limits: -40 °C ... +180 °C
- on request -60 °C ... +180 °C with silicone gasket
- (>125 °C up to 180 °C with RY inserts)

MGOE and MGVE



CGCE



CGCP MB
Dust protection
cover
(from page 697)



CAVUS® Type
4/4X/12



according to IEC/EN 60529

E-Xtreme®

CG and MG high protection IP68 version E-Xtreme®

inserts		page:
CD	64 poles + ⊕	72
CDD	108 poles + ⊕	81
CDS	42 poles + ⊕	-
CDSH	42 poles + ⊕	89
CNE	24 poles + ⊕	113
CSE	24 poles + ⊕	-
CSH	24 poles + ⊕	113
CSH S	24 poles + ⊕	125
CCE	24 poles + ⊕	133
CMSH	10+2 (aux) poles + ⊕	140
CMCE	10+2 (aux) poles + ⊕	141
CSS	24 poles + ⊕	151
CQE	46 poles + ⊕	171
CQEE	64 poles + ⊕	177
CX	4/8 and 6/6 poles + ⊕	204, 206
MIXO	6 modules	262 - 317

**bulkhead mounting housings
screw locking**



3.000 HOURS

**surface mounting housings
screw locking**



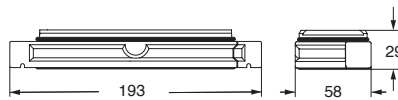
3.000 HOURS

description	part No.	part No.	entry
			M

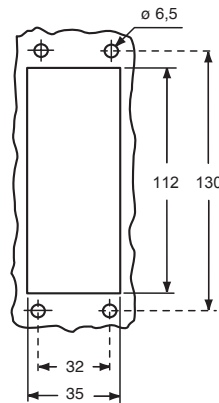
with gasket, size "104.27"	CGIE 24		
size "104.27"		MGPE 24.40	40
size "104.27"		MGPE 24.240	40 x 2

- 3.000 hours in salt spray tests (EN ISO 9227)
- temperature limits: -40 °C ... +180 °C
- on request -60 °C ... +180 °C with silicone gasket
- (>125 °C up to 180 °C with RY inserts)

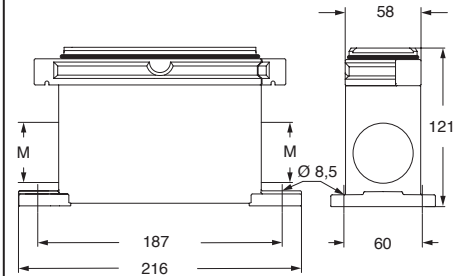
CGIE



panel cut-out for bulkhead mounting housings



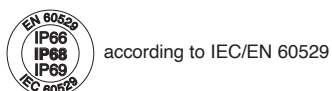
MGPE



CGCP FX
Dust protection
cover
(from page 697)



CAIUS® Type
4/4X/12



CG and MG high protection IP68 version E-Xtreme®

inserts		page:
CD	64 poles + ⊕	72
CDD	108 poles + ⊕	81
CDS	42 poles + ⊕	-
CDSH	42 poles + ⊕	89
CNE	24 poles + ⊕	113
CSE	24 poles + ⊕	-
CSH	24 poles + ⊕	113
CSH S	24 poles + ⊕	125
CCE	24 poles + ⊕	133
CMSH	10+2 (aux) poles + ⊕	140
CMCE	10+2 (aux) poles + ⊕	141
CSS	24 poles + ⊕	151
CQE	46 poles + ⊕	171
CQEE	64 poles + ⊕	177
CX	4/8 and 6/6 poles + ⊕	204, 206
MIXO	6 modules	262 - 317

hoods, screw locking



3.000 HOURS

covers, screw locking

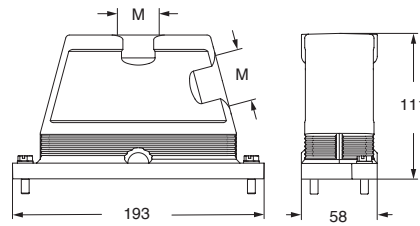


3.000 HOURS

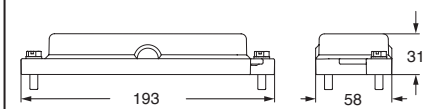
description	part No.	entry M	part No.
with side entry			
size "104.27"	MGOE 24.32	32	
size "104.27"	MGOE 24.40	40	
size "104.27"	MGOE 24.50	50	
with top entry			
size "104.27"	MGVE 24.325	25 x 3	
size "104.27"	MGVE 24.32	32	
size "104.27"	MGVE 24.232	32 x 2	
size "104.27"	MGVE 24.40	40	
size "104.27"	MGVE 24.240	40 x 2	
size "104.27"	MGVE 24.50	50	
size "104.27"			CGCE 24

- 3.000 hours in salt spray tests (EN ISO 9227)
- temperature limits: -40 °C ... +180 °C
- on request -60 °C ... +180 °C with silicone gasket
- (>125 °C up to 180 °C with RY inserts)

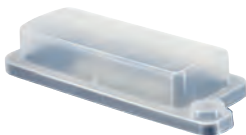
MGOE and MGVE



CGCE



CGCP MB
Dust protection
cover
(from page 697)



CAUS® Type
4/4X/12

according to IEC/EN 60529

EMC

Directives and standards

The concept of **Electromagnetic Compatibility (EMC)** is the reversal in the positive sense of what was until recently known as **Electromagnetic Interference (EMI)**: **we have electromagnetic compatibility** between a device and the environment (including surrounding equipment) when there is no reciprocal electromagnetic interference or when this is within tolerable limits.

In other words, **to obtain electromagnetic compatibility**, measures must be adopted aimed at bringing the electrical or electronic equipment to levels of **emission** and electromagnetic **immunity** against electromagnetic interference such that it continues to function properly without causing disturbance to other equipment present in the surrounding environment.

In the electrical equipment of industrial machines, rectangular multipole connectors with their metallic enclosures are widely used due to their high standards of safety, reliability, mechanical robustness and resistance to corrosion and pollution.

These connectors are passive electromechanical components: they do not generate electromagnetic interference and are not disturbed in their function. Taken by themselves, therefore, they fall outside the scope of Directive 2014/30/EU on electromagnetic compatibility and the CE marking is therefore not required for EMC aspects: it still applies, however, under the Low Voltage Directive 2014/35/EU.

It is rather the devices and industrial equipment mentioned above, in which the connectors are for the most part used (e.g. on-board electric panels) which, taken as a whole, must be CE marked also for EMC aspects, having to meet the essential requirements of the EMC Directive.

For the EMC in **industrial environments** two European standards are in force, not intended for specific equipment, which regulate the **emissions** and **immunity** of devices.

These are therefore generic standards, one for **emissions EN 61000-6-4:2007 + A1:2011** (class. CEI 210-66:2007 + 210-66;V1:2011, equivalent to IEC 61000-4:2006 + A1:2010) and one for **immunity EN 61000-6-2:2005** (class. CEI 210-54:2006, equivalent to IEC 61000-6-2:2005) ¹⁾.

These apply in the absence of provisions in the particular EMC product standards or in the total absence of the latter.

For industrial equipment, when appliances are not intentionally designed to generate radio frequencies ²⁾, the latter case applies (no particular standards). In the European standards for switchgear and controlgear (EN 60947-1) and in those for the electrical equipment of machines (EN 60204-1 emission and immunity limits have been for some time in the process of being issued, as well as their verification, if necessary, with reference to above mentioned EMC standards for industrial environment.

EMC testing should not be performed on individual components, but rather on the entire apparatus, sometimes not without inconsiderable logistical difficulties, due to their size, reproducing as far as possible their operation in real operating conditions.

It is therefore incorrect to assign limits of electromagnetic emission and immunity imposed on the equipment on, for example, electrical connectors used as components of the equipment.

¹⁾ There are two similar standards for the other standardized environment, defined as **residential, commercial and light industrial environment**, respectively EN 61000-6-3:2007 + A1:2011 (class. CEI 210-65:2007 + CEI 210-61;V1:2011) for emissions (equivalent to IEC 61000-6-3:2006 + A1:2010) and EN 61000-6-1:2007 (class. CEI 210-64:2007) for immunity (equivalent to IEC 61000-6-1:2006).

²⁾ In which case for such devices, called **ISM (industrial, scientific, medical)** the – EN 55011:2007 standard for emission of radio interference would apply.

Electromagnetic interference and ILME connectors

Many years ago the entry into force of the first EMC European Directive, with requirement for electrical and electronic equipment to comply with the levels of electromagnetic pollution dictated by the standards, brought renewed interest in all the appropriate steps to mitigate the effects of electromagnetic interference.

Electromagnetic interference can occur in two forms: **conducted or radiated**. With reference to connectors, **conducted interference** transmitted on conductors wired to the connectors, is, for example: harmonics, superimposed on the voltage of the power supply at 50 Hz, caused by withdrawal of biased current or by electromechanical or electronic switches, or radio frequency interference noise which is inductively or capacitively coupled with the cable, overlapping transported signals.

This is characterized by frequency and amplitude (intensity) and can be filtered to some extent, in both in the outgoing (emission) and incoming (immunity) directions, only via in-line passive electrical filters, which the designer of the electrical equipment must foresee since he is the only one with a knowledge of all the terms of the problem ³⁾.

Radiated interference, transmitted in the form of electromagnetic waves, is characterized by the values of amplitude of associated electric (V/m) and magnetic fields and with the frequency or frequency band (rarely is this located on a single frequency, more often it occupies a band). This may come from inside the device: in this case it is necessary to mitigate emissions. Or from the outside, in which case it is necessary to raise immunity.

By test convention, **interference with frequency up to 30 MHz** is considered to be conducted and **irradiated with frequency above 30 MHz up to 1 GHz**.

The sources of electromagnetic interference are classified as **intentional** and **unintentional**.

The first (e.g. radio-telecommunication antennas, mobile phones) use high frequency electromagnetic fields for functional reasons. For the second (e.g. ignition of internal combustion engines, electric arc furnaces) they are a by-product.

In most industrial applications, compared to the overall EMC issues of a device, connectors (inserts + enclosures), taken by themselves, are not the priority concern of the designer.

The enclosures of the low-frequency industrial connectors, taking shape as a barrier to a "shell", are implicitly a "peripheral" aspect: the designer of electrical equipment / electronics will take care first of all the "core" of the EMC problem, that of the active components inside of their systems, by limiting the emissions and enhance immunity.

In fact, to have significant problems due to radiation through the opening constituted by a connector enclosure on a control panel, there must be a particularly "efficient" radiofrequency source inside the panel.

Essentially, significant design errors must have been committed regarding the EMC of the entire equipment.

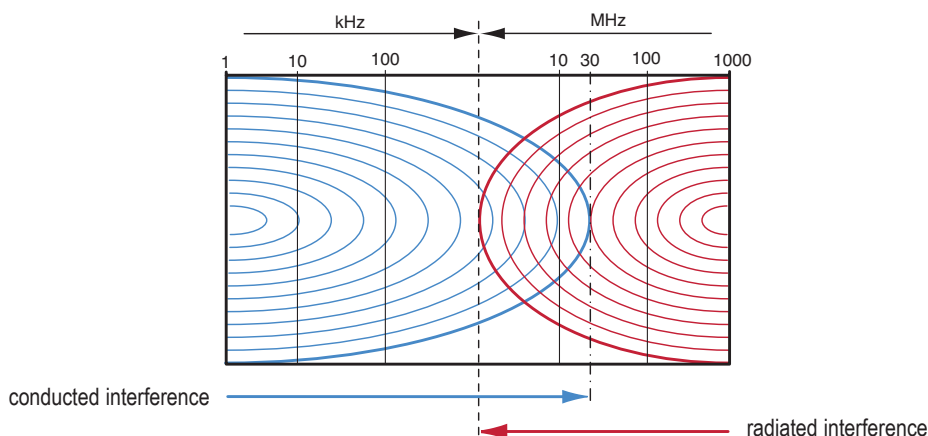
In certain cases the coupling of connectors may constitute the weak link in the chain, for example where it is not possible for functional reasons to further reduce interference of the electronics inside the control panel. In these cases one must rely on the efficiency of the shield. Even if the equipment manufacturer uses shielded fabrication and high quality shielded cables, continuity and homogeneity of such shielding could be significantly degraded precisely in the passage between free connector and panel.

In dealing with electromagnetic compatibility of electrical equipment of an industrial machine, a second aspect to be addressed as a priority is the presence of large quantities of interface cabling.

In these cases, the significant attenuation of the shield necessary for the cables must not be jeopardised by the connector enclosures due to imperfect earthing of the cable shield.

It should nevertheless be pointed out that increasing shielding may not be sufficient to solve possible problems and should be considered as a complementary choice.

³⁾ For example, for trapezoidal D-Sub type connectors for digital data transmission, there are connectors on the market which incorporate "general purpose" filters for any conducted interference.



Electromagnetic shielding

of connectors: fundamental principles

To consider the electromagnetic compatibility aspects of an electrical/electronic device in the final verification rather than in the design phase almost always leads to a substantial increase in overall development time and costs.

The designer who deals with electromagnetic compatibility issues should use the same rules and the same precautions regardless of whether the equipment is subsequently shielded.

Numerous products meet electromagnetic compatibility standards without the use of shielding. However, when all other limiting interventions are impossible or uneconomical, recourse to increased efficiency of the electromagnetic shield is the only answer.

An **electromagnetic shield** is a barrier to the transmission of electromagnetic fields.

To generalise the concept to include conducted emissions, a filter can be considered as a shield. We will restrict ourselves here to considering a shield as a barrier to radiated emissions.

The metallic containers which completely enclose an electrical/electronic device or a part thereof **constitute an electromagnetic shield**, with the task of preventing the emissions of electrical/electronic devices or a part thereof to radiate outside the equipment container itself.

A cable connected to a device is part of the same for the purposes of electromagnetic compatibility.

A flexible multicore cable is shielded by surrounding the insulated conductors with a conductive metal mesh.

An electromagnetic shield is characterized by a parameter which measures its efficiency.

The shielding attenuation is the ratio between the radiated power generated inside a device and the residual radiated power outside the unit. The attenuation introduced by a shield can be measured by comparing the absence and presence of the shield.

Shielding attenuation is measured in dB (decibel). 20 dB is equivalent to an order of magnitude, i.e. attenuation of a factor of 10, 40 dB = attenuation of a factor of 100, etc.

To obtain large shielding attenuation values (e.g. 100 dB) the shield must completely enclose the electronic device and not have any means of access from the outside, such as openings, joints, cracks or cables. Any means of access through a shield, if not properly treated, can drastically reduce the efficiency of the shield.

EMC connector enclosures and accessories

In light of the foregoing, ILME has developed for the designers of the electrical/electronic equipment of machines the EMC series of connector enclosures and accessories.

Available as bulkhead mounting housings and hood versions in the various sizes 44.27, 57.27, 77.27 and 104.27, they maintain the robustness and reliability of standard types whilst possessing increased high frequency shielding characteristics.

In the development of EMC enclosures recourse to geometrical modifications compared to the standard versions has been avoided so as not to affect their dimensional compatibility with the latter: in using

The passage of a cable through a shield must be properly considered. One common method is to place filters on the cable at which it crosses the shield. Another is to use shielded cables, with their shields connected for the entire perimeter to the equipment shield.

To reduce radiated emissions of a cable, the cable shield must be connected to a point with zero potential (an ideal ground therefore, not the "signal" ground of an electronic circuit).

To achieve electromagnetic shielding conductive materials (metals) are used.

Shielding attenuation depends mainly on the electrical conductivity of the material and the thickness of the shield.

Rectangular or square connectors – special case – intrinsically *anisotropic*, are more difficult to shield and less predictable in behaviour than circular connectors (isotropic geometry) used, not by accident, with coaxial terminations for RF applications.

Connector enclosures are typically made of aluminium die cast alloy, an excellent metal for shielding electric fields because it is an excellent conductor. It is also better than steel in shielding phenomena of an impulsive nature (typical example is electrostatic discharge) which cause interference in the high frequency spectrum and is among the most insidious and dangerous.

It is important to ensure electrical continuity along the boundary of the enclosure, not only to ensure high shielding attenuation but also to avoid accumulation of static electricity.

It is important not to "economically" tip the balance of a screening system which is only as effective as its weakest component.

A good shielded cable has a shield attenuation greater than that attributable to the connector, but only for very small lengths of cable (e.g. one metre). When the length of the shielded cable increases, shield attenuation is significantly reduced.

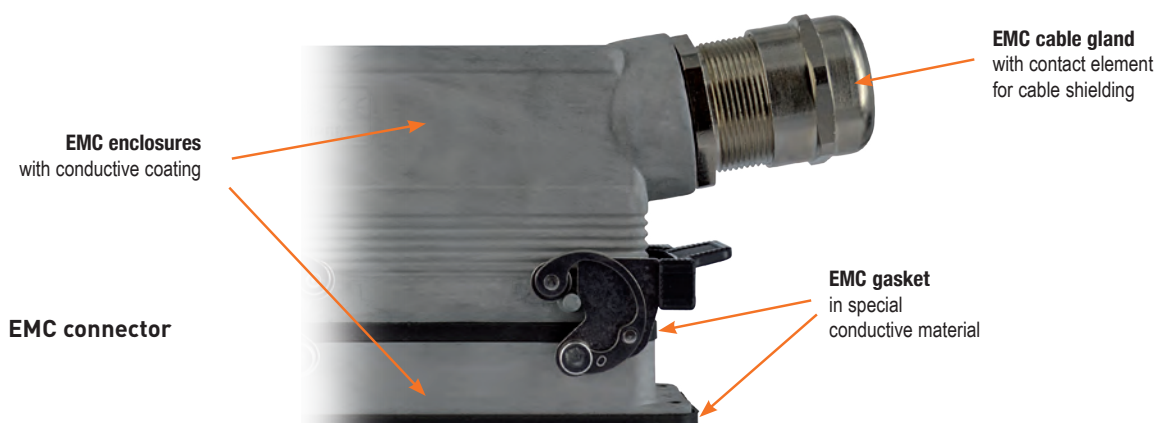
This indicates that it is much more important to improve the shield quality of cables, which are mainly responsible for radiated interference emissions and in an electrical system are often present in considerable quantity, before that of the connector.

What dramatically increases the efficiency of shielding is the quality of its connection to the conductor: EMC cable glands create a very homogeneous and continuous contact between the cable shield and connector enclosure.

EMC enclosures the equipment designer need not foresee any changes in layout due to increased dimensions and need not renounce the convenience of the traditional locking lever closures.

The increase in shielding attenuation is achieved primarily by providing a homogeneous and as uniform as possible electrical continuity of earthing to the cable shield in the connection between cable and hood and between hood and housing.

At the contact between the bulkhead-mounting housings and the fixing surface a special conductive gasket is foreseen.



The enclosure surfaces are treated to make them extremely conductive while maintaining the necessary corrosion resistance.

The bulkhead mounting housing has a special conductive gasket.

For best results the surface underneath the gasket should be conductive. Since the use of this enclosure system presupposes the use of shielded cables, the hood should comprise a special cable gland with anchoring device for the cable shield.

These metal cable glands ensure IP66 protection rating, are resistant to corrosion and equipped internally with a contact element with geometry that ensures uniform earthing of the cable conductor shield on the metal shell of the hood.

Even with standard enclosures (not EMC), the contact with an EMC cable gland between the cable shield and the connector housing, permanently earthed through to the connector insert inside, produces an attenuation of

electromagnetic interference on average higher (by approx. 6 – 15 dB up to 600 MHz, corresponding to a factor of 2 – 5,6) than the attenuation achieved by connecting the shield mesh directly to the earth terminal of the connector insert.

The reasons for this are:

- the uniform 360° contact via the contact device of the EMC cable gland avoids what instead happens when the shield mesh is earthed to the earth terminal of the connector, i.e. the discontinuity of the shield which necessarily opens precisely around the connector;
- more efficient distribution of induced current circulating on the shield mesh;
- directly involving the metal shell constituted by the enclosure avoids transmitting interference to the connector, as happens when the shield is connected to the earth terminal of the connector.

Experimental tests

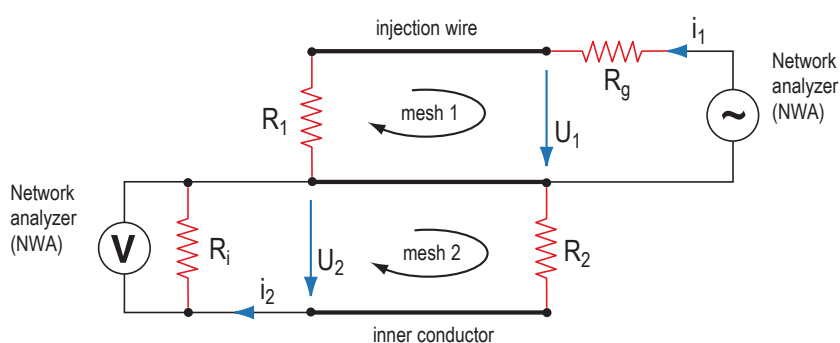
Tests for measurement of the shielding of ILME special EMC enclosures for multipole rectangular connectors for industrial use were conducted at the CESI EMC Laboratory in Milan, national notified body for certification under the EMC Directive. Shielding attenuation of a component is defined as the ratio of the power radiated within the component and the maximum interference power outside the component in the room (**VG 95214-11**).

For a connector it can be expressed, in analogy with cables, as a function of transfer impedance, which is the ratio between the voltage induced in the shield and the current flowing outside the same. The transfer impedance measurement is a widely used and accepted method to determine shielding attenuation of coaxial cables and connectors.

Only recently, due to the increase in digital data transmission speeds and the increase in frequencies of transmitted signals, the issue of identifying efficient and repeatable methods for measuring shielding efficiency, also for connectors traditionally considered low frequency, has been addressed at a regulatory level.

An experimental method for determining surface transfer impedance of coupled low frequency connectors is still being studied by IEC.

The method chosen by ILME for verification of its system of EMC enclosures and accessories is the **line injection method** based on German military standards **VG 95214-10** and **VG 95214-11**.



Legend:

- R_g = output impedance of the signal generator (NWA port1)
- R_1 = termination resistance of the generator circuit (mesh 1)
- R_i = input impedance of the measuring instrument (NWA port 2)
- R_2 = termination resistance of the generator circuit (mesh 2)

Connectors and electromagnetic compatibility

A signal with a frequency of 0,1 MHz to 1000 MHz generated by port 1 of the measuring device (a network analyzer with 75 Ω output impedance) circulates in the mesh 1 consisting of an insulated conductor (injection wire) resting on the surface of two coupled enclosures (shield), terminating on a calibrated (and shielded) resistance of 75 Ω. As a result of the current i_1 injected in the mesh 1, an induced voltage U_2 is generated in the mesh 2, consisting of an inner pick-up conductor connected to two

contacts at the center of the connector inserts, terminated on another calibrated resistance of 75 Ω (shielded), in turn earthed on the coupled enclosures which act as a shield. The voltage is measured on port 2 of the measuring device for S parameters (scattering parameters). The network analyzer sees the device under test as a filter and calculates the measurement providing a graph illustrating the **shielding attenuation** (measured in dB) as a function of frequency in MHz.

The tests were performed on:
 - coupled standard enclosures
 - coupled EMC enclosures

The results are summarized in the diagrams below.

Figure 1 - Standard enclosure diagram

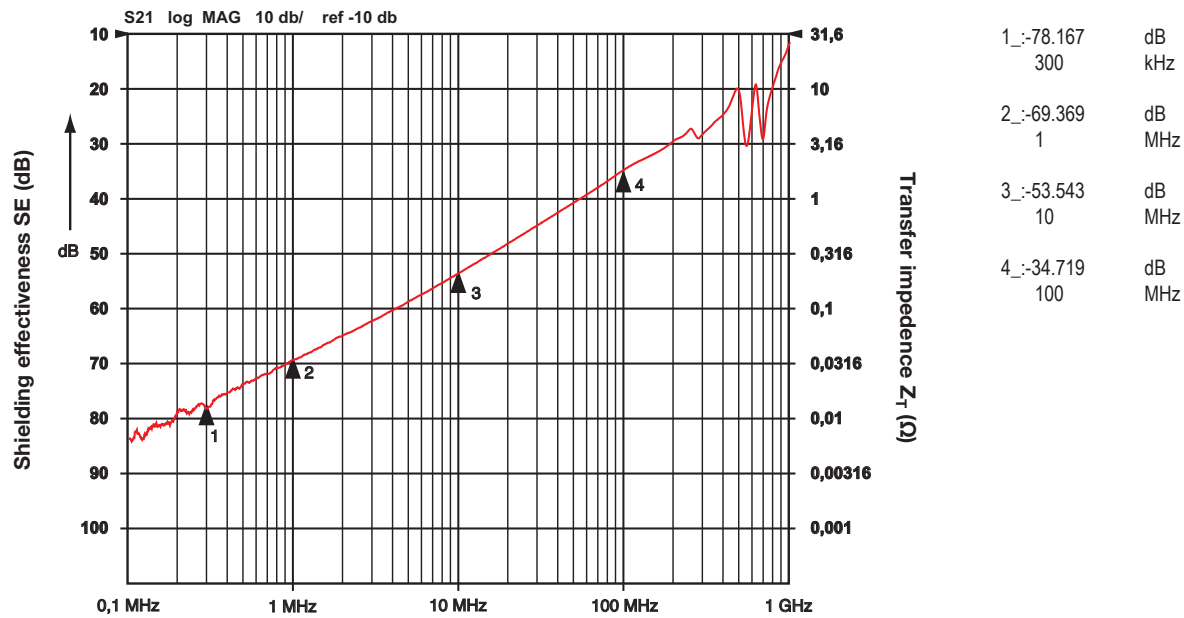
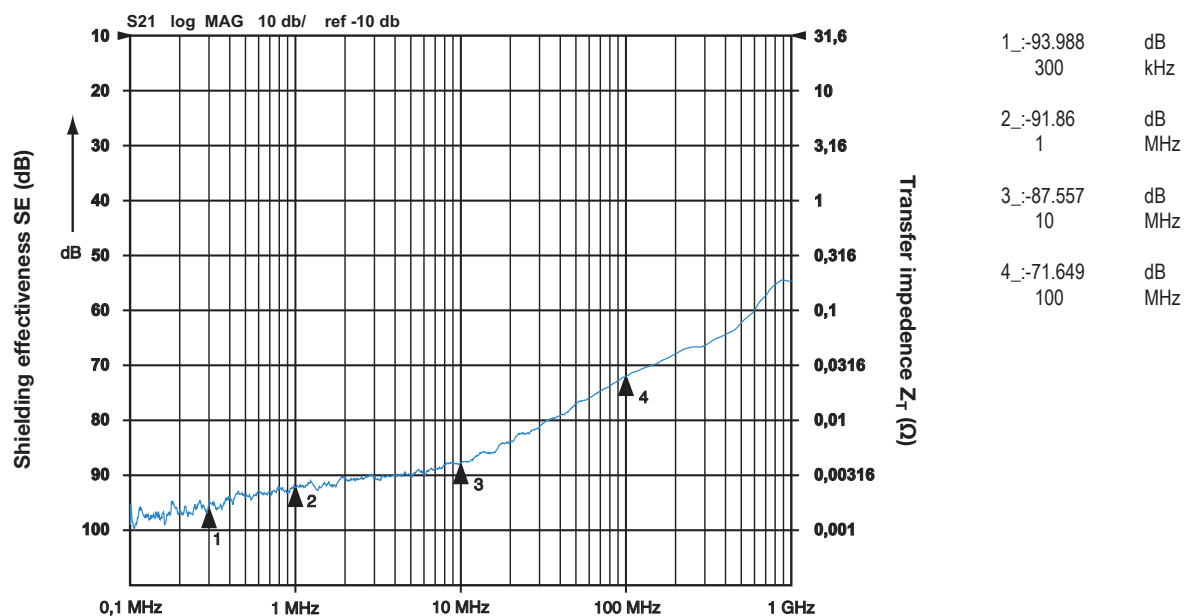


Figure 2 - EMC enclosure diagram



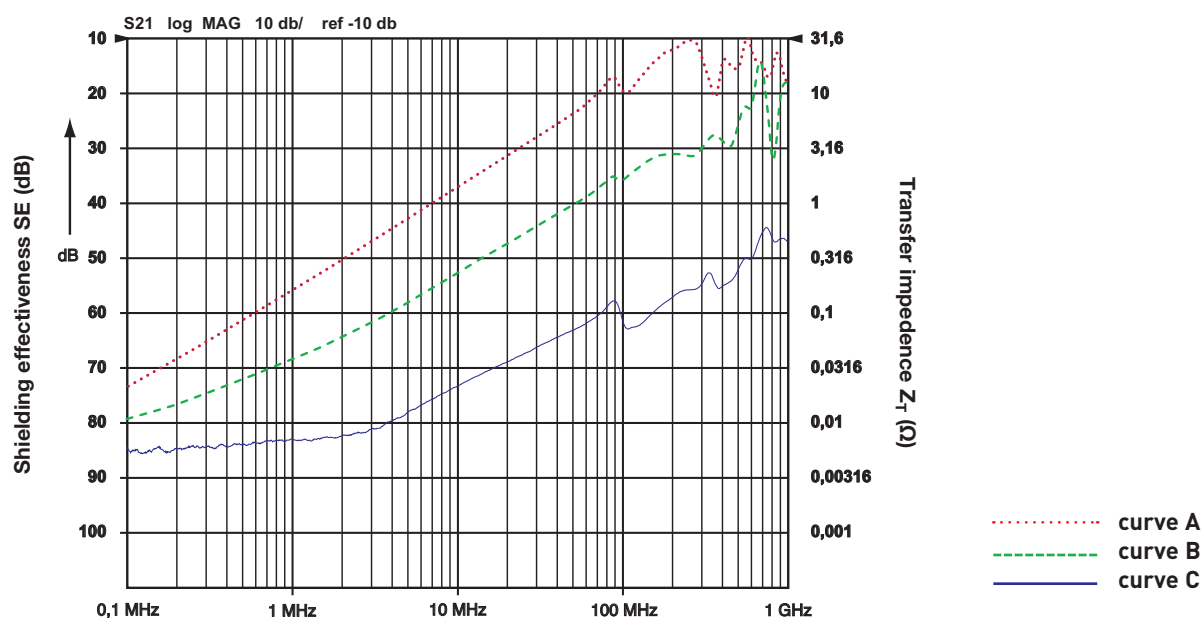
To highlight the influence of the cable gland the shielding attenuation measurements were repeated on:

- coupled standard enclosures with standard cable gland and cable shield earthed to the earth terminal of the connector
see curve A
- coupled standard enclosures with EMC cable gland and cable shield earthed to the cable gland
see curve B

- coupled EMC enclosures with EMC cable gland and cable shield earthed to the cable gland
see curve C

The results are summarized in the diagrams of Figure 3 below.

Figure 3 - Overview diagrams



NOTE

For the relationship between Shielding effectiveness SE and Transfer impedance (Ω) see also IEC 60512-23-3: $SE = 40 - 20_{\log} 10Z_T$ (dB)

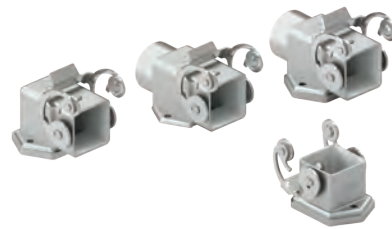
Conclusions

The measurements suggest the following considerations:

- standard enclosures already provide good levels of shielding attenuation;
- when used with EMC cable glands, standard enclosures clearly increase their shielding attenuation;
- EMC enclosures, with better shielding attenuation values, provide further improvements.

inserts		page:
CK	3 poles + ⊕	58
CK	4 poles + ⊕	58
CKS	3 poles + ⊕	-
CKS	4 poles + ⊕	-
CKSH	3 poles + ⊕	63
CKSH	4 poles + ⊕	63
CD	8 poles	67
CQ4	2 poles + ⊕	182
CQ4 H	2 poles + ⊕	183
CQ4	3 poles + ⊕	184
CQ	5 poles + ⊕	186
CQ	7 poles + ⊕	187
CQ	12 poles + ⊕	189
CQ	21 poles	190

bulkhead mounting housings straight and angled



hoods



description	part No. (entry Pg 11)	part No. (entry M20)	part No. (entry Pg 11)	part No. (entry M20 / M25)
with stainless steel lever and gasket	CKAXS 03 I			
without cable entry, with stainless steel lever and gasket ¹⁾	CKAXS 03 IA			
with cable entry, with stainless steel lever and gasket ¹⁾	CKAXS 03 IAP	MKAXS IAP20		
with cable entry, with stainless steel lever and gasket bulkhead hole closed ¹⁾	CKAXS 03 AP	MKAXS AP20		
with pegs, top entry ¹⁾			CKAS 03 V	MKAS V20
with pegs, top entry				MKAS V25
with pegs, side entry ¹⁾			CKAS 03 VA	MKAS VA20
with stainless steel lever, top entry ¹⁾			CKAXS 03 VG	MKAXS VG20
gasket and screw kit for IP66/IP67/IP69 ²⁾	CKR 65		CKR 65	
for CK, CKSH, CQ4, CQ inserts				
gasket and screw kit for IP66/IP67/IP69 ²⁾	CKR 65 D		CKR 65 D	
for CD 08 inserts				

¹⁾ Not suitable for CQ4 series inserts

²⁾ To obtain the IP66/IP67/IP69 degree of protection it is necessary to replace the fixing screw supplied with all inserts, with the one with gasket included in the kit (to be purchased separately) **except for** the inserts listed below (already supplied with a fixing screw with gasket):

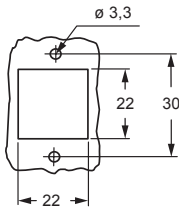
- CQF/M 07, CQF/M 12

NOTE: The enclosure shown here is an example. The screw and sealing gasket kit can be used with all enclosures' part nos. in this page



versions with glued gasket (DESINA®) upon request

panel cut-out for bulkhead mounting housings

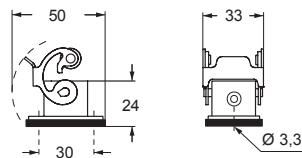


CAIUS® Type 12
Type 4/4X only
with CKR 65 (D)

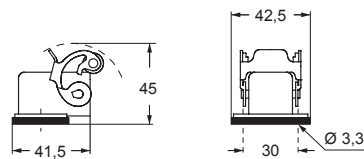


IP66/IP67/IP69 with CKR 65 (D) ²⁾

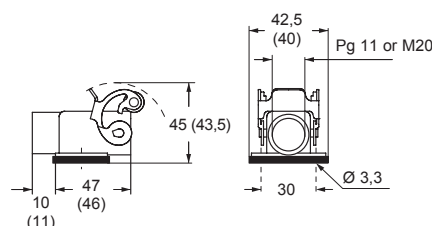
CKAXS I



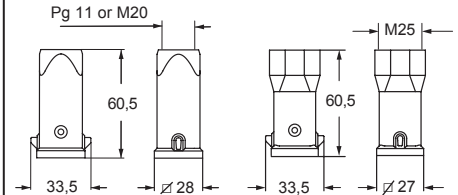
CKAXS IA



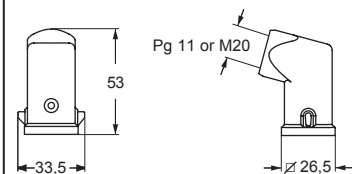
CKAXS IAP (CKAXS AP) and MKAXS IAP (MKAXS AP)



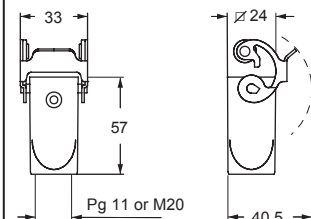
CKAS V and MKAS V MKAS V25



CKAS VA and MKAS VA



CKAXS VG and MKAXS VG



CKAX - CKA - CKAXX EMC version for electromagnetic compatibility

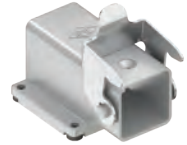
inserts		page:
CK	3 poles + ⊕	58
CK	4 poles + ⊕	58
CKS	3 poles + ⊕	-
CKS	4 poles + ⊕	-
CKSH	3 poles + ⊕	63
CKSH	4 poles + ⊕	63
CD	8 poles	67
CQ4	2 poles + ⊕	182
CQ4 H	2 poles + ⊕	183
CQ4	3 poles + ⊕	184
CQ	5 poles + ⊕	186
CQ	7 poles + ⊕	187
CQ	12 poles + ⊕	189
CQ	21 poles	190

angled bulkhead mounting housings with stainless steel lever



angled bulkhead mounting housings with galvanized steel rigid lever and stainless steel rigid lever

GALVANIZED ²⁾



STAINLESS ³⁾



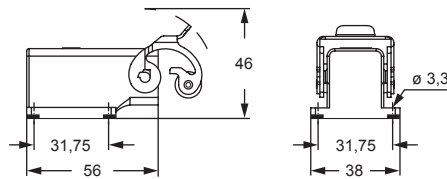
description	part No.	part No.
without cable entry, fixing by 4 screws	CKAXS 03 IA4	
without cable entry, fixing by 4 screws ²⁾		CKAS 03 IA4
without cable entry, fixing by 4 screws ³⁾		CKAXXS 03IA4
gasket and screw kit for IP66/IP67/IP69 ¹⁾ for CK, CKSH, CQ4, CQ inserts	CKR 65	CKR 65
gasket and screw kit for IP66/IP67/IP69 ¹⁾ for CD 08 inserts	CKR 65 D	CKR 65 D

¹⁾ To obtain the IP66/IP67/IP69 degree of protection it is necessary to replace the fixing screw supplied with all inserts, with the one with gasket included in the kit (to be purchased separately) **except for** the inserts listed below (already supplied with a fixing screw with gasket):
 - CQF/M 07, CQF/M 12

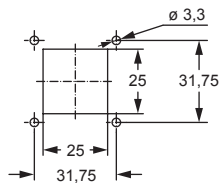
NOTE: The enclosure shown here is an example. The screw and sealing gasket kit can be used with all enclosures' part nos. in this page



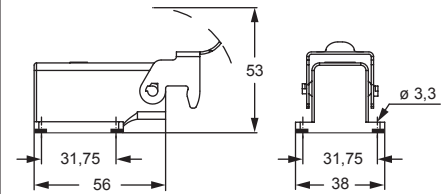
CKAXS IA4



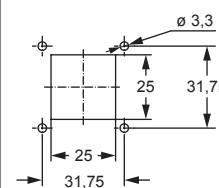
panel cut-out for enclosures



CKAS IA4 - CKAXXS IA4



panel cut-out for enclosures



CAIUS®
 Type 12
 Type 4/4X only
 with CKR 65 (D)



IP44 IP66/IP67/IP69 with CKR 65 (D) ¹⁾

MKAX EMC version for electromagnetic compatibility

inserts	page:
CK 3 and 4 poles + ⊕	58
CKS 3 and 4 poles + ⊕	-
CKSH 3 and 4 poles + ⊕	63
CD 8 poles	67
CQ4 2 poles + ⊕	182
CQ4 H 2 poles + ⊕	183
CQ4 3 poles + ⊕	184
CQ 5 poles + ⊕	186
CQ 7 poles + ⊕	187
CQ 12 poles + ⊕	189
CQ 21 poles	190

if the counterpart has glued gasket:

CLK 04 SC	239
CX 1/2 BD	243
CXL 2/4 PF/PM	251
CXL 2/4 PFH/PMH	251
CXL PF/PM	251

angled surface mounting housings with stainless steel lever



angled surface mounting housings with stainless steel lever

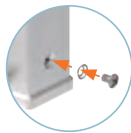


description	part No. (entry M25)	part No. (entry M25)
with cable entry, fixing by 4 screws	MKAXS IAP25	
with cable entry, fixing by 4 screws, bulkhead hole closed (without gasket)		MKAXS AP25
gasket and screw kit for IP66/IP67/IP69 1) for CK, CKSH, CQ4, CQ, inserts	CKR 65	CKR 65
gasket and screw kit for IP66/IP67/IP69 1) for CD 08 inserts	CKR 65 D	CKR 65 D

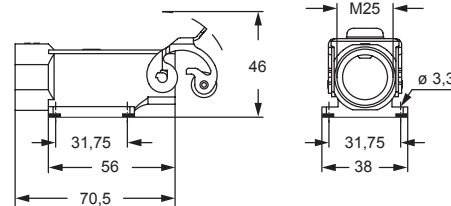
1) To obtain the IP66/IP67/IP69 degree of protection it is necessary to replace the fixing screw supplied with all inserts, with the one with gasket included in the kit (to be purchased separately) **except for** the inserts listed below (already supplied with a fixing screw with gasket):

- CQF/M 07, CQF/M 12
- CX 1/2 BDF/M
- CLK 04 SCF /SCF-H /SCM
- CXL 2/4 PF /PM /PFH /PMH, CXL PF/PM

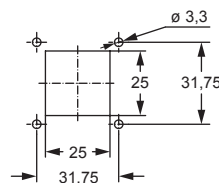
NOTE: The enclosure shown here is an example. The screw and sealing gasket kit can be used with all enclosures' part nos. in this page



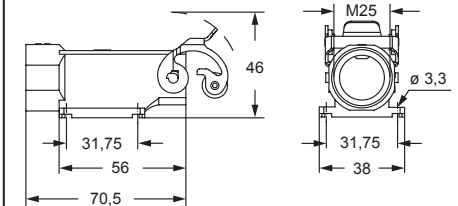
MKAXS IAP25



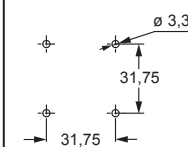
panel cut-out for enclosures



MKAXS AP25



panel cut-out for enclosures



Type 12
Type 4/4X only
with CKR 65 (D)



IP66/IP67/IP69 with CKR 65 (D) 1)

MKA - MKAXX EMC version for electromagnetic compatibility

inserts	page:
CK 3 and 4 poles + ⊕	58
CKS 3 and 4 poles + ⊕	-
CKSH 3 and 4 poles + ⊕	63
CD 8 poles	67
CQ4 2 poles + ⊕	182
CQ4 H 2 poles + ⊕	183
CQ4 3 poles + ⊕	184
CQ 5 poles + ⊕	186
CQ 7 poles + ⊕	187
CQ 12 poles + ⊕	189
CQ 21 poles	190

if the counterpart has glued gasket:	
CLK 04 SC	239
CX 1/2 BD	243
CXL 2/4 PF/PM	251
CXL 2/4 PFH/PMH	251
CXL PF/PM	251

angled surface mounting housings with galvanized steel rigid lever



angled surface mounting housings with stainless steel rigid lever



description	part No. (entry M25)	part No. (entry M25)
with cable entry, fixing by 4 screws	MKAS IAP25	
with cable entry, fixing by 4 screws, bulkhead hole closed (without gasket)	MKAS AP25	
with cable entry, fixing by 4 screws		MKAXXS IAP25
with cable entry, fixing by 4 screws, bulkhead hole closed (without gasket)		MKAXXS AP25
gasket and screw kit for IP66/IP67 ¹⁾ for CK, CKSH, CQ4, CQ, inserts	CKR 65	CKR 65
gasket and screw kit for IP66/IP67 ¹⁾ for CD 08 inserts	CKR 65 D	CKR 65 D

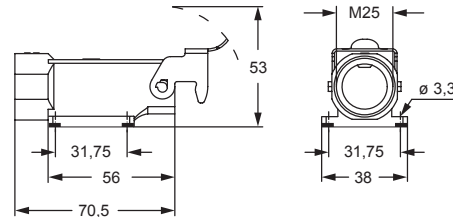
¹⁾ To obtain the IP66/IP67/IP69 degree of protection it is necessary to replace the fixing screw supplied with all inserts, with the one with gasket included in the kit (to be purchased separately) **except for** the inserts listed below (already supplied with a fixing screw with gasket):

- CQF/M 07, CQF/M 12
- CX 1/2 BDF/M
- CLK 04 SCF /SCF-H /SCM
- CXL 2/4 PF /PM /PFH /PMH, CXL PF/PM

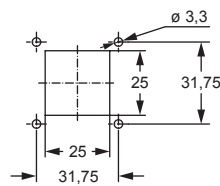
NOTE: The enclosure shown here is an example. The screw and sealing gasket kit can be used with all enclosures' part nos. in this page



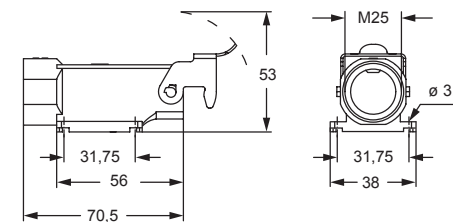
MKAS IAP25



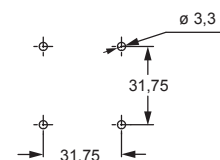
panel cut-out for enclosures



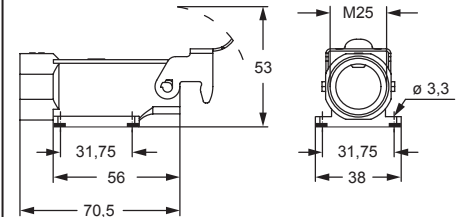
MKAS AP25



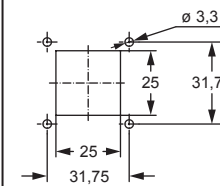
panel cut-out for enclosures



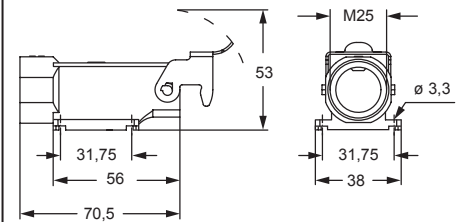
MKAXXS IAP25



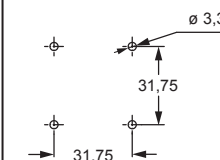
panel cut-out for enclosures



MKAXXS AP25



panel cut-out for enclosures



Type 12
Type 4/4X only
with CKR 65 (D)



IP66/IP67/IP69 with CKR 65 (D) ¹⁾

MKAX EMC version for electromagnetic compatibility

inserts		page:
CK	3 and 4 poles + ⊕	58
CKS	3 and 4 poles + ⊕	-
CKSH	3 and 4 poles + ⊕	63
CD	8 poles	67
CQ4	2 poles + ⊕	182
CQ4 H	2 poles + ⊕	183
CQ4	3 poles + ⊕	184
CQ	5 poles + ⊕	186
CQ	7 poles + ⊕	187
CQ	12 poles + ⊕	189
CQ	21 poles	190

if the counterpart has glued gasket:

CJ KF	223
CJK 8FT	226
CLK 04 SC	239
CX 1/2 BD	243
CXL 2/4 SF/SM	250
CXL SF/SM	250
CXL 2/4 PF/PM	251
CXL 2/4 PFH/PMH	251
CXL PF/PM	251

bulkhead mounting housings with stainless steel lever

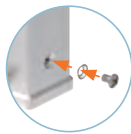


description	part No. (entry M32)
M32 fixing thread (*) 1)	MKAXS IF
gasket and screw kit for IP66/IP67/IP69 1)	CKR 65
gasket and screw kit for IP66/IP67/IP69 1) specific for CD 08 inserts	CKR 65 D

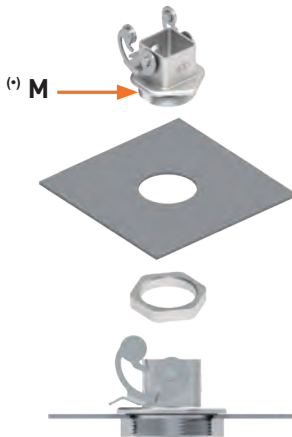
1) To obtain the IP66/IP67/IP69 degree of protection it is necessary to replace the fixing screw supplied with all inserts, with the one with gasket included in the kit (to be purchased separately) **except for** the inserts listed below (already supplied with a fixing screw with gasket):

- CQF/M 07, CQF/M 12
- CJ KF
- CJK 8FT
- CX 1/2 BDF/M
- CLK 04 SCF /SCF-H /SCM
- CXL 2/4 PF /PM /PFH /PMH /SF /SM, CXL SF/M
- CXL PF /PM

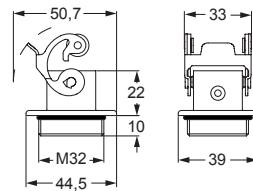
NOTE: The enclosure shown here is an example. The screw and sealing gasket kit can be used with all enclosures' part nos. in this page



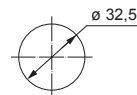
(*) Locknut supplied on request, see Cable glands catalogue (article AS M32N metallic).



MKAXS IF



panel cut-out for enclosures



CAVUS® Type 12
Type 4/4X only
with CKR 65 (D)



IP66/IP67/IP69 with CKR 65 (D) 1)

MKA - MKAXX EMC version for electromagnetic compatibility

inserts		page:
CK	3 and 4 poles + ⊕	58
CKS	3 and 4 poles + ⊕	-
CKSH	3 and 4 poles + ⊕	63
CD	8 poles	67
CQ4	2 poles + ⊕	182
CQ4 H	2 poles + ⊕	183
CQ4	3 poles + ⊕	184
CQ	5 poles + ⊕	186
CQ	7 poles + ⊕	187
CQ	12 poles + ⊕	189
CQ	21 poles	190

if the counterpart has glued gasket:

CJ KF	223
CJK 8FT	226
CLK 04 SC	239
CX 1/2 BD	243
CXL 2/4 SF/SM	250
CXL SF/SM	250
CXL 2/4 PF/PM	251
CXL 2/4 PFH/PMH	251
CXL PF/PM	251

bulkhead mounting housings with galvanized steel rigid lever



bulkhead mounting housings with stainless steel rigid lever

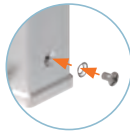


description	part No. (entry M32)	part No. (entry M32)
M32 fixing thread (*) 1)	MKAS IF	
M32 fixing thread (*) 1)		MKAXXS IF
gasket and screw kit for IP66/IP67/IP69 1)	CKR 65	CKR 65
gasket and screw kit for IP66/IP67/IP69 1) specific for CD 08 inserts	CKR 65 D	CKR 65 D

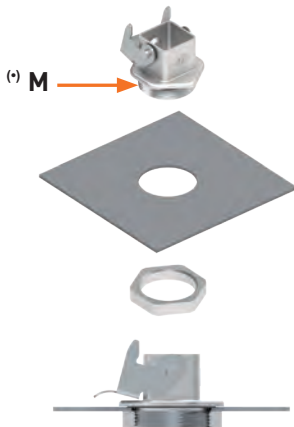
1) To obtain the IP66/IP67/IP69 degree of protection it is necessary to replace the fixing screw supplied with all inserts, with the one with gasket included in the kit (to be purchased separately) **except for** the inserts listed below (already supplied with a fixing screw with gasket):

- CQF/M 07, CQF/M 12
- CJ KF
- CJK 8FT
- CX 1/2 BDF/M
- CLK 04 SCF /SCF-H /SCM
- CXL 2/4 PF /PM /PFH /PMH /SF /SM, CXL SF/M
- CXL PF /PM

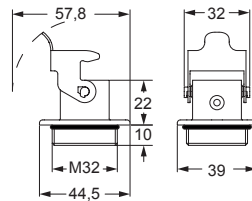
☑ NOTE: The enclosure shown here is an example. The screw and sealing gasket kit can be used with all enclosures' part nos. in this page



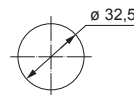
(*) Locknut supplied on request, see Cable glands catalogue (article AS M32N metallic).



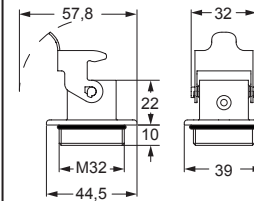
MKAS IF



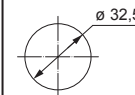
panel cut-out for enclosures



MKAXXS IF



panel cut-out for enclosures



CAVUS®
Type 12
Type 4/4X only
with CKR 65 (D)

IP44 IP66/IP67/IP69 with CKR 65 (D) 1)

MKAX EMC version for electromagnetic compatibility

inserts		page:
CK	3 and 4 poles + ⊕	58
CKS	3 and 4 poles + ⊕	-
CKSH	3 and 4 poles + ⊕	63
CD	8 poles	67
CQ	5 poles + ⊕	186
CQ	7 poles + ⊕	187
CQ	12 poles + ⊕	189
CQ	21 poles	190

if the counterpart has glued gasket:

CLK 04 SC	239
CX 1/2 BD	243
CXL 2/4 PF/PM	251
CXL 2/4 PFH/PMH	251
CXL PF/PM	251

bulkhead mounting housings with stainless steel lever

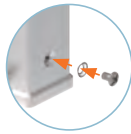


description	part No. (entry M20)
M20 cable entry 1)	MKAXS IVG20
gasket and screw kit for IP66/IP67/IP69 1)	CKR 65
gasket and screw kit for IP66/IP67/IP69 1) specific for CD 08 inserts	CKR 65 D

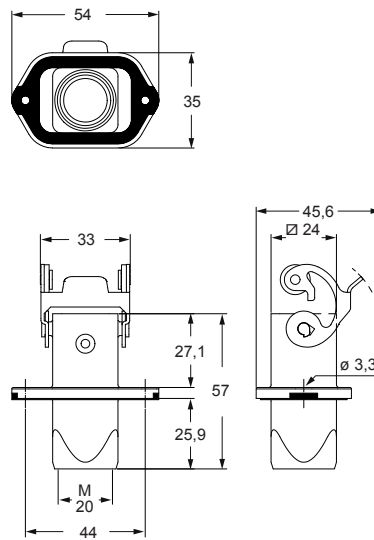
1) To obtain the IP66/IP67/IP69 degree of protection it is necessary to replace the fixing screw supplied with all inserts, with the one with gasket included in the kit (to be purchased separately) **except for** the inserts listed below (already supplied with a fixing screw with gasket):

- CQF/M 07, CQF/M 12
- CX 1/2 BDF/M
- CLK 04 SCF /SCF-H /SCM
- CXL 2/4 PF /PM /PFH /PMH /SF /SM
- CXL PF /PM

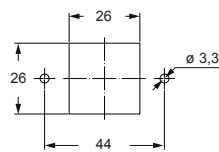
NOTE: The enclosure shown here is an example. The screw and sealing gasket kit can be used with all enclosures' part nos. in this page



MKAXS IVG20



panel cut-out for enclosures



CAIUS® Type 12
Type 4/4X only
with CKR 65 (D)



IP66/IP67/IP69 with CKR 65 (D) 1)

MKA - MKAXX EMC version for electromagnetic compatibility

inserts	page:
CK 3 and 4 poles + ⊕	58
CKS 3 and 4 poles + ⊕	-
CKSH 3 and 4 poles + ⊕	63
CD 8 poles	67
CQ 5 poles + ⊕	186
CQ 7 poles + ⊕	187
CQ 12 poles + ⊕	189
CQ 21 poles	190

if the counterpart has glued gasket:

CLK 04 SC	239
CX 1/2 BD	243
CXL 2/4 PF/PM	251
CXL 2/4 PFH/PMH	251
CXL PF/PM	251

bulkhead mounting housings with galvanized steel rigid lever



bulkhead mounting housings with stainless steel rigid lever

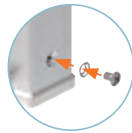


description	part No. (entry M20)	part No. (entry M20)
M20 cable entry 1)	MKAS IVG20	
M20 cable entry 1)		MKAXXS IVG20
gasket and screw kit for IP66/IP67/IP69 1)	CKR 65	CKR 65
gasket and screw kit for IP66/IP67/IP69 1) specific for CD 08 inserts	CKR 65 D	CKR 65 D

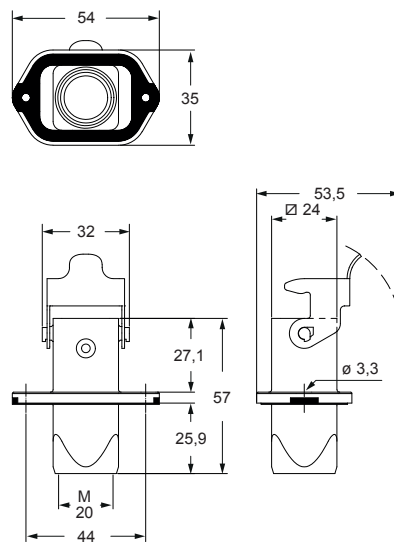
1) To obtain the IP66/IP67/IP69 degree of protection it is necessary to replace the fixing screw supplied with all inserts, with the one with gasket included in the kit (to be purchased separately) **except for** the inserts listed below (already supplied with a fixing screw with gasket):

- CQF/M 07, CQF/M 12
- CX 1/2 BDF/M
- CLK 04 SCF /SCF-H /SCM
- CXL 2/4 PF /PM /PFH /PMH /SF /SM
- CXL PF /PM

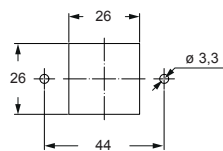
NOTE: The enclosure shown here is an example. The screw and sealing gasket kit can be used with all enclosures' part nos. in this page



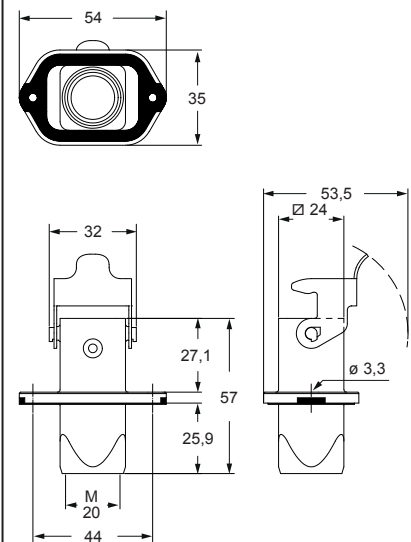
MKAS IVG20



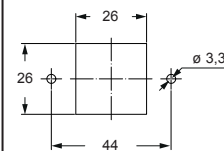
panel cut-out for enclosures



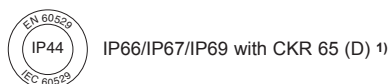
MKAXXS IVG20



panel cut-out for enclosures



CAIUS®
Type 12
Type 4/4X only
with CKR 65 (D)



MKAX - MKA - MKAXX EMC version for electromagnetic compatibility

inserts		page:
CK	3 and 4 poles + ⊕	58
CKS	3 and 4 poles + ⊕	-
CKSH	3 and 4 poles + ⊕	63
CD	8 poles	67
CQ4	2 poles + ⊕	182
CQ4 H	2 poles + ⊕	183
CQ4	3 poles + ⊕	184
CQ	5 poles + ⊕	186
CQ	7 poles + ⊕	187
CQ	12 poles + ⊕	189
CQ	21 poles + ⊕	190

if the counterpart has glued gasket:

CLK 04 SC	239
CX 1/2 BD	243
CXL 2/4 PF/PM	251
CXL 2/4 PFH/PMH	251
CXL PF/PM	251

hoods with stainless steel lever




hoods with galvanized steel rigid lever and stainless steel rigid lever

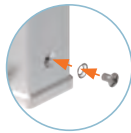


description	part No. (entry M25)	part No. (entry M25)
top entry	MKAXS VG25	
top entry ²⁾		MKAS VG25
top entry ³⁾		MKAXXS VG25
gasket and screw kit for IP66/IP67/IP69 ¹⁾	CKR 65	CKR 65
gasket and screw kit for IP66/IP67/IP69 ¹⁾ for CD 08 inserts	CKR 65 D	CKR 65 D

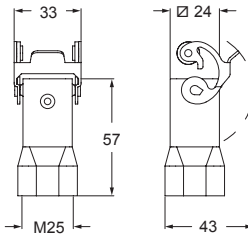
¹⁾ To obtain the IP66/IP67/IP69 degree of protection it is necessary to replace the fixing screw supplied with all inserts, with the one with gasket included in the kit (to be purchased separately) **except for** the inserts listed below (already supplied with a fixing screw with gasket):

- CQF/M 07, CQF/M 12
- CX 1/2 BDF/M
- CLK 04 SCF /SCF-H /SCM
- CXL 2/4 PF /PM /PFH /PMH, CXL PF/PM

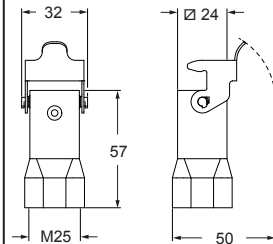
 **NOTE:** The enclosure shown here is an example. The screw and sealing gasket kit can be used with all enclosures' part nos. in this page



MKAXS VG25



MKAS VG25 - MKAXXS VG25



CAVUS® Type 12
Type 4/4X only
with CKR 65 (D)



IP66/IP67/IP69 with CKR 65 (D) ¹⁾

CQ EMC version for electromagnetic compatibility

inserts		page:
CQ 04/2	4 poles + 2 poles + ⊕	191
CQ 08	8 poles + ⊕	192
CQ 17	17 poles + ⊕	193

metallized insulating enclosures

bulkhead mounting housings with single lever



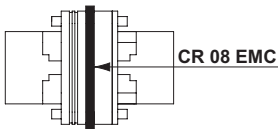
angled bulkhead mounting housings with single lever



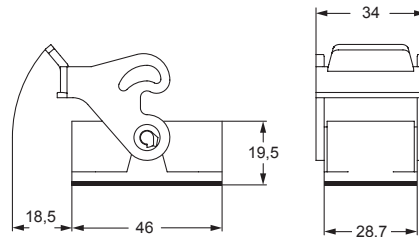
description	part No.	entry Pg
with lever and gasket	CQS 08 I	
without cable gland, with lever, angled	CQS 08 IA	
with cable entry, with lever, angled	CQS 08 IAP	21

ASSEMBLY INSTRUCTIONS

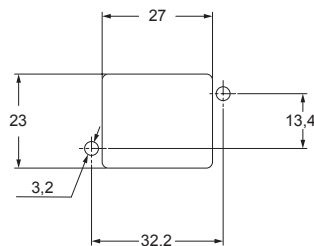
When using an EMC "CQS 08" series enclosure with a male insert, replace the standard gasket provided on the male insert with a conductive gasket CR 08 EMC, to be ordered separately (see page 575).



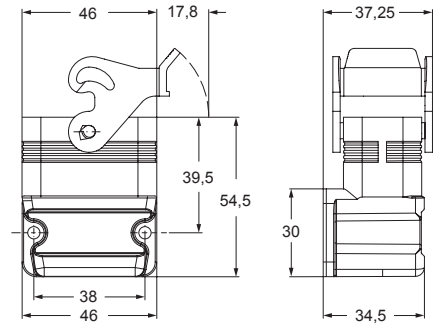
CQS I



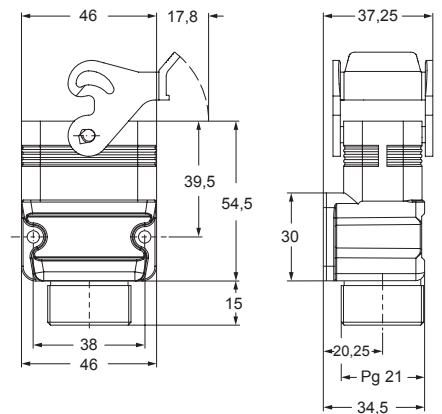
panel cut-out for CQS I enclosure



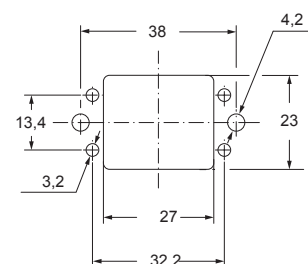
CQS IA



CQS IAP



panel cut-out for CQS IA - CQS IAP enclosure



CEC® US Type 12



CQ EMC version for electromagnetic compatibility

inserts

CQ 04/2	4 poles + 2 poles + ⊕
CQ 08	8 poles + ⊕
CQ 17	17 poles + ⊕

page:

191
192
193

hoods with 2 pegs



hoods with single lever



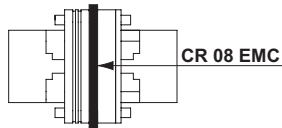
metallized insulating enclosures

description	part No.	entry Pg	part No.	entry Pg
with pegs, side entry ¹⁾	CQS 08 VA	16		
with pegs, top entry ¹⁾	CQS 08 V	21		
with lever, top entry ¹⁾			CQS 08 VG	21

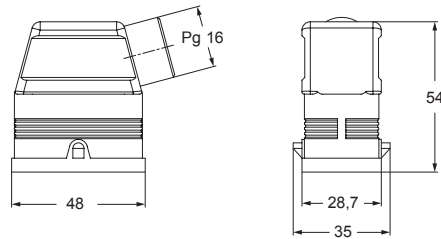
¹⁾ Pg male thread on exterior enclosure

ASSEMBLY INSTRUCTIONS

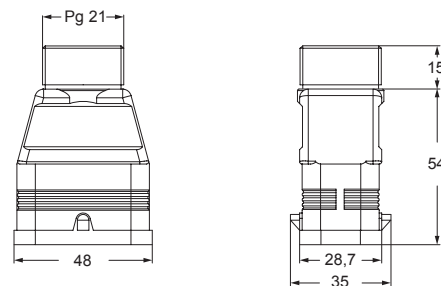
When using an EMC "CQS 08" series enclosure with a male insert, replace the standard gasket provided on the male insert with a conductive gasket CR 08 EMC, to be ordered separately (see page 575).



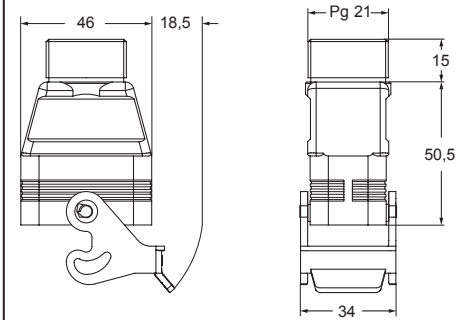
CQS VA



CQS V



CQS VG



CAUS Type 12



EMC

CR - CRQ EMC version for electromagnetic compatibility

conductive gasket for CQM male inserts



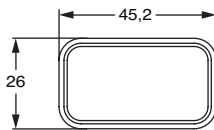
thermoplastic resin cable glands



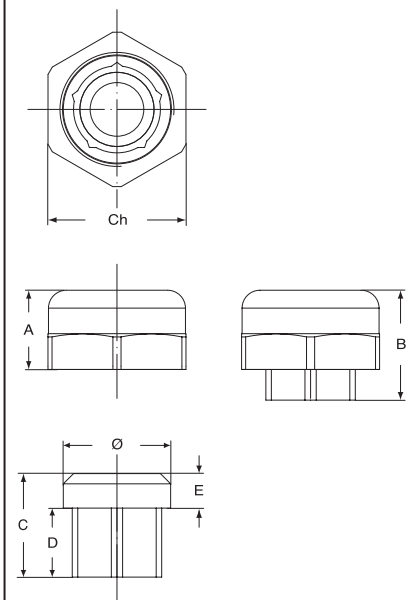
description	part No.	part No.
-------------	----------	----------

conductive gasket for CQM male inserts	CR 08 EMC	
cable gland head and gasket for CQS 08 VA enclosure		CRQ 16
cable gland head and gasket for CQS 08 V, VG and IAP enclosure		CRQ 21

CR 08 EMC



CRQ 16 and CRQ 21

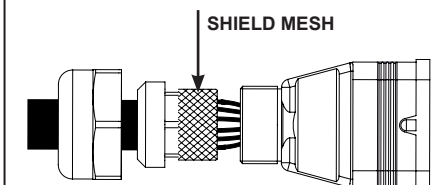


part No.	A	B	C	D	E	Ø	Ch
CRQ 16	15,5	21,5	20,25	13,5	6,75	21	27
CRQ 21	18,2	27,5	25	15,5	9	26,5	33

cable diameters for cable glands:
 - **CRQ 16**: 10 - 14,5 mm (4 - 7 mm on request)
 - **CRQ 21**: 14 - 18 mm (7 - 10 mm on request)

ASSEMBLY INSTRUCTIONS

Place the cable shield mesh between the CRQ cable gland gasket and the seat of the gasket itself.



EMC

CZ - MZ and CZF - MZF EMC version for electromagnetic compatibility

inserts		page:
CD	15 poles + ⊕	68
CDA	10 poles + ⊕	98
CSAH	10 poles + ⊕	99
CDC	10 poles + ⊕	104
MIXO	1 module	264 - 316

Covers **cannot be used together** with metal coding pins.

housings and cover



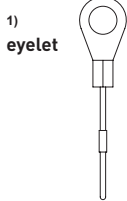
hoods and cover



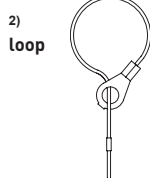
description	part No.		entry		part No.		entry	
			Pg	M			Pg	M
bulkhead mounting housing with lever	CZ7IS 15 L	--						
surface mounting housing with lever	CZ7PS 15 L2	16 x 2			MZ7PS 15L225	25 x 2		
cover with pegs and gasket (for 1 lever enclosures) ¹⁾	CZCS 15 L							
enclosure with pegs and gasket, side entry					CZOS 15 L	16		MZOS 15 L20 20
enclosure with pegs and gasket, side entry								MZOS 15 L25 25
enclosure with pegs and gasket, side entry, high construction, without adapter ³⁾					CZFOS 15 L21	21		MZFOS 15 L25 25
enclosure with pegs and gasket, top entry					CZVS 15 L	13,5		MZVS 15 L20 20
enclosure with pegs and gasket, top entry, high construction, without adapter ³⁾					CZFVS 15L221	21		MZFVS 15 L25 25
cover with lever (for enclosures with pegs) ²⁾					CZ7CS 15 LG			

³⁾ enclosure without adapter, threaded on the enclosure body, to be used only with a complete cable gland.

For fixing on housings



For fixing on hoods



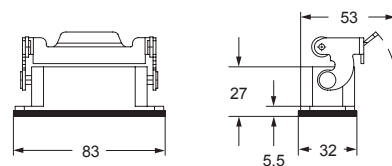
CAVUS® Type 4/4X/12

IP65 insulating cable gland or fittings without gasket

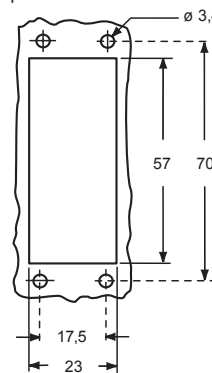
IP66 cable gland with O-Ring gasket

IP67 cable gland with O-Ring gasket for housings coupled with either a cover or a hood without adapter ● and for hoods coupled with a cover with lever ●

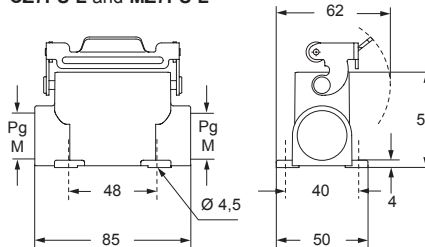
CZ7IS L



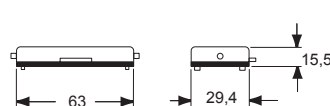
panel cut-out for bulkhead mounting housings



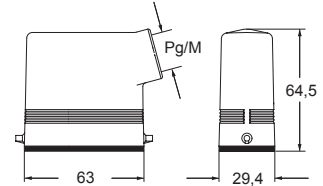
CZ7PS L and MZ7PS L



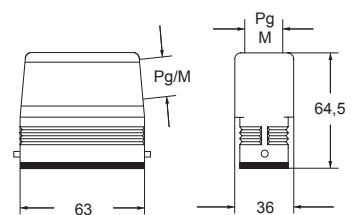
CZCS L ●



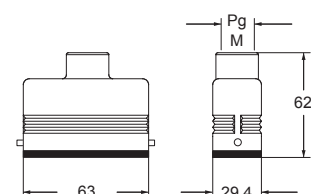
CZOS L and MZOS L ●



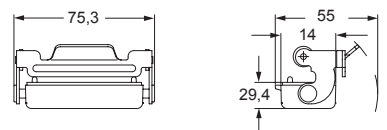
CZFOS L - MZFOS L and CZFVS L - MZFVS L



CZVS L and MZVS L ●



CZ7CS LG ●



CZ - MZ and CZF - MZF EMC version for electromagnetic compatibility

inserts		page:
CD	25 poles + ⊕	69
CDD	38 poles + ⊕	77
CDA	16 poles + ⊕	100
CSAH	16 poles + ⊕	101
CDC	16 poles + ⊕	105

Covers **cannot be used together** with metal coding pins.

housings and cover



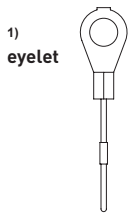
hoods and cover



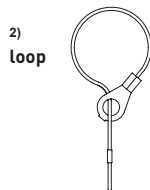
description	part No.	entry Pg	part No.	entry M	part No.	entry Pg	part No.	entry M
bulkhead mounting housing with lever	CZ7IS 25 L	--						
surface mounting housing, with lever, high construction	CZ7PS 25 L2	16 x 2	MZ7PS 25L225	25 x 2				
cover with pegs and gasket (for 1 lever enclosures) ¹⁾	CZCS 25 L							
enclosure with pegs and gasket, side entry					CZOS 25 L	16	MZOS 25 L20	20
enclosure with pegs and gasket, side entry							MZOS 25 L25	25
enclosure with pegs and gasket, side entry, high construction, without adapter ³⁾					CZFOS 25 L21	21	MZFOS 25 L25	25
enclosure with pegs and gasket, top entry					CZVS 25 L	16		
enclosure with pegs and gasket, top entry ⁴⁾							MZVS 25 L20	20
enclosure with pegs and gasket, top entry, high construction, without adapter ³⁾					CZVFS 25 L21	21	MZVFS 25 L25	25
cover with lever (for enclosures with pegs) ²⁾					CZ7CS 25 LG			

³⁾ enclosure without adapter, threaded on the enclosure body, to be used only with a complete cable gland.
⁴⁾ can only be used with a complete cable gland (to be purchased separately)

For fixing on housings



For fixing on hoods



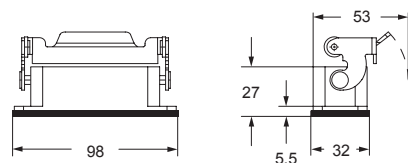
CRUS® Type 4/4X/12

insulating cable gland or fittings without gasket

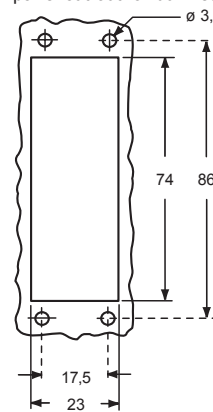
cable gland with O-Ring gasket

cable gland with O-Ring gasket for housings coupled with either a cover or a hood without adapter ● and for hoods coupled with a cover with lever ●

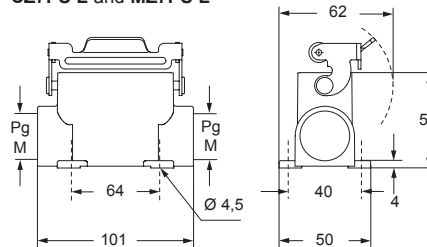
CZ7IS L



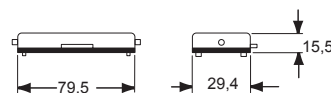
panel cut-out for bulkhead mounting housings



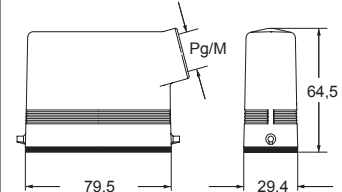
CZ7PS L and MZ7PS L



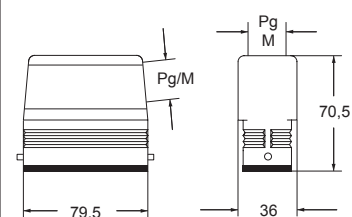
CZCS L ●



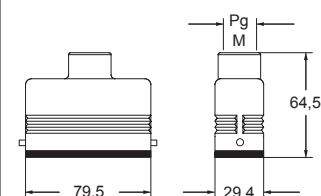
CZOS L and MZOS L ●



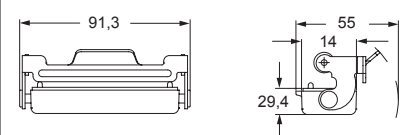
CZFOS L - MZFOS L and CZVFS L - MZVFS L



CZVS L and MZVS L ⁴⁾ ●



CZ7CS LG ●



inserts		page:
CDD	24 poles + ⊕	76
CDS	9 poles + ⊕	-
CDSH	9 poles + ⊕	86
CDSH NC	6 poles + ⊕	95
CNE	6 poles + ⊕	110
CSE	6 poles + ⊕	-
CSH	6 poles + ⊕	110
CSH S	6 poles + ⊕	122
CCE	6 poles + ⊕	130
CSS	6 poles + ⊕	148
CT, CTSE (16A) *	6 poles + ⊕	160
CQE	10 poles + ⊕	168
MIXO	2 modules	262 - 317

*) only for enclosure CHIS 06 L

housings and cover



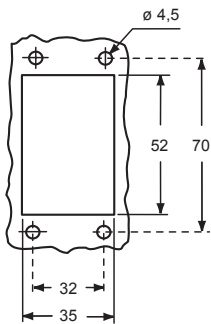
hoods and cover



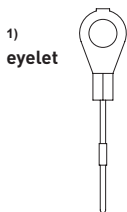
description	part No.	entry Pg	part No	entry M	part No.	entry Pg	part No.	entry M
bulkhead mounting housing with lever and gasket	CHIS 06 L	--						
surface mounting housing, with lever, high construction	CAPS 06 L	21	MAPS 06 L32	32				
cover with pegs (for 1 lever enclosures) ¹⁾	CHCS 06 L							
cover with pegs (for 1 lever enclosures) ²⁾	CHCS 06 SL							
enclosure with pegs, side entry, high construction, without adaptor ³⁾					CFOS 06 L21	21	MFOS 06 L32	32
enclosure with pegs, top entry, high construction, without adaptor ³⁾					CFVS 06 L21	21	MFVS 06 L32	32
cover with lever (for enclosures with pegs) ²⁾					CHCS 06 LG			

³⁾ enclosure without adapter, threaded on the enclosure body, to be used only with a complete cable gland.

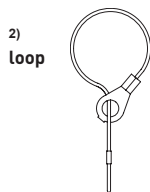
panel cut-out for bulkhead mounting housings



For fixing on housings



For fixing on hoods



CAU® Type 4/4X/12

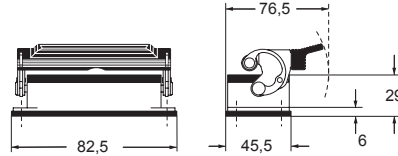


insulating cable gland or fittings without gasket

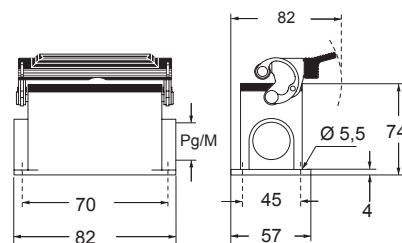


cable gland with O-Ring gasket

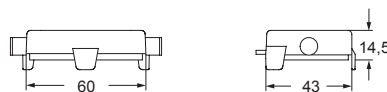
CHIS L



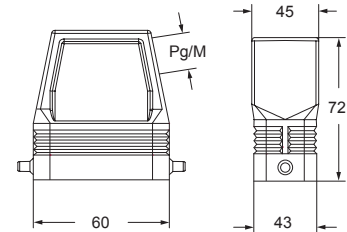
CAPS L and MAPS L



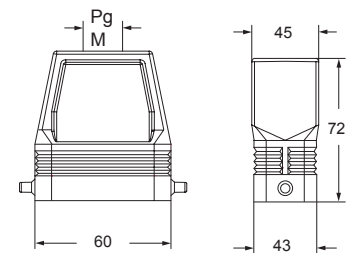
CHCS L - CHCS SL



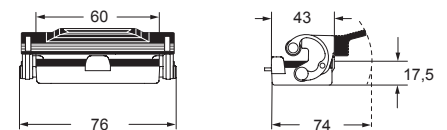
CFOS L and MFOS L



CFVS L and MFVS L



CHCS LG

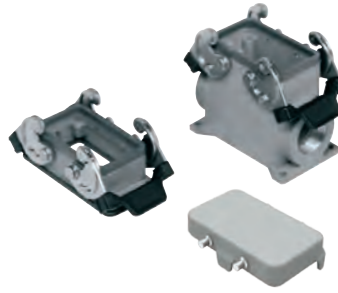


CH - CA and MA EMC version for electromagnetic compatibility

inserts		page:
CDD	42 poles + ⊕	78
CDS	18 poles + ⊕	-
CDSH	18 poles + ⊕	87
CNE	10 poles + ⊕	111
CSE	10 poles + ⊕	-
CSH	10 poles + ⊕	111
CSH S	10 poles + ⊕	123
CCE	10 poles + ⊕	131
CMSH	3+2 (aux) poles + ⊕	136
CMCE	3+2 (aux) poles + ⊕	137
CSS	10 poles + ⊕	149
CT, CTSE (16A) *)	10 poles + ⊕	161
CQE	18 poles + ⊕	169
CX	8/24 poles + ⊕	194
MIXO	3 modules	262 - 317

*) only for enclosure CHIS 10

housings and cover

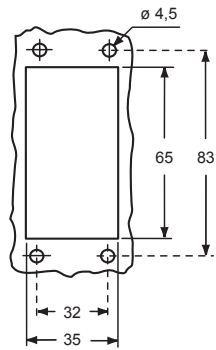


hoods and cover

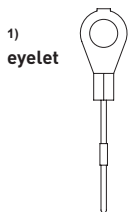


description	part No.	entry Pg	part No.	entry M	part No.	entry Pg	part No.	entry M
bulkhead mounting housing with levers and gasket	CHIS 10	--						
surface mounting housing, with levers, high construction	CAPS 10.21	21	MAPS 10.32	32				
cover with 4 pegs (for enclosures with 2 levers) ¹⁾	CHCS 10							
cover with 4 pegs (for enclosures with 2 levers) ²⁾	CHCS 10 S							
enclosure with pegs, side entry, high construction					CAOS 10.21	21	MAOS 10.32	32
enclosure with pegs, top entry, high construction					CAVS 10.21	21	MAVS 10.32	32
cover with 2 levers (for enclosures with 4 pegs) ²⁾					CHCS 10 G			

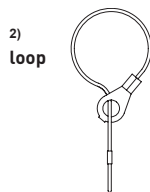
panel cut-out for bulkhead mounting housings



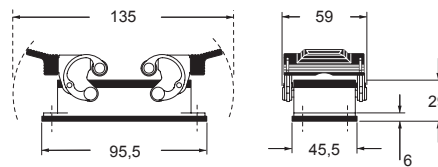
For fixing on housings



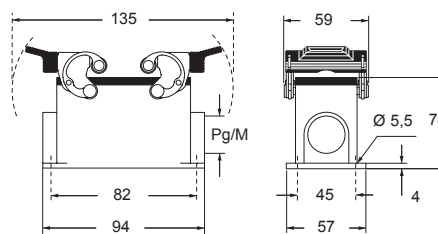
For fixing on hoods



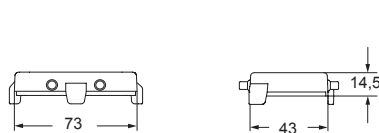
CHIS



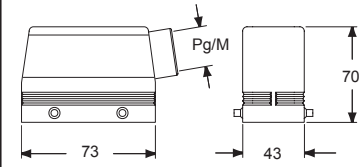
CAPS and MAPS



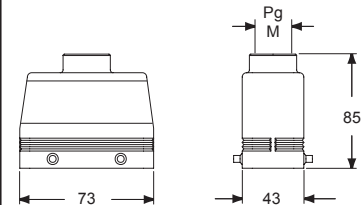
CHCS - CHCS S



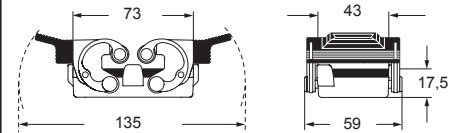
CAOS and MAOS



CAVS and MAVS



CHCS G



CAUS® Type 4/4X/12

insulating cable gland or fittings without gasket

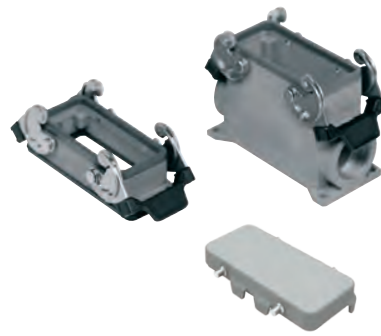
cable gland with O-Ring gasket

CH - CA and MH - MA EMC version for electromagnetic compatibility

inserts		page:
CD	40 poles + ⊕	70
CDD	72 poles + ⊕	79
CDS	27 poles + ⊕	-
CDSH	27 poles + ⊕	88
CNE	16 poles + ⊕	112
CSE	16 poles + ⊕	-
CSH	16 poles + ⊕	112
CSH S	16 poles + ⊕	124
CCE	16 poles + ⊕	132
CMSH, CMCE	6+2 (aux) poles + ⊕	138 - 139
CSS	16 poles + ⊕	150
CT, CTS (10A) *)	40 poles + ⊕	156
CT, CTSE (16A) *)	16 poles + ⊕	162
CQE	32 poles + ⊕	170
CQEE	40 poles + ⊕	176
CP	6 poles + ⊕	178
CX	6/12, 6/36 and 12/2 poles + ⊕	197 - 199
CX	4/0 and 4/2 poles + ⊕	200 - 201
MIXO	4 modules	262 - 317

*) only for enclosure CHIS 16

housings and cover

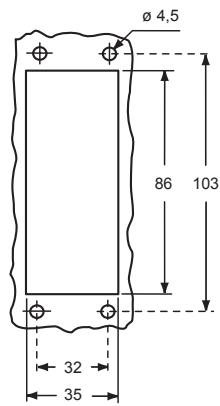


hoods and cover

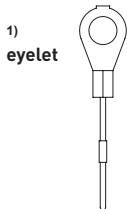


description	part No.	entry Pg	part No	entry M	part No.	entry Pg	part No.	entry M
bulkhead mounting housing with levers and gasket	CHIS 16	--						
surface mounting housing, with levers, high construction	CAPS 16.21	21	MAPS 16.32	32				
cover with 4 pegs (for enclosures with 2 levers) ¹⁾	CHCS 16							
cover with 4 pegs (for enclosures with 2 levers) ²⁾	CHCS 16 S							
enclosure with pegs, side entry					CHOS 16	21	MHOS 16.25	25
enclosure with pegs, side entry							MHOS 16.32	32
enclosure with pegs, side entry, high construction					CAOS 16.29	29	MAOS 16.32	32
enclosure with pegs, side entry, high construction							MAOS 16.40	40
enclosure with pegs, top entry					CHVS 16	21	MHVS 16.25	25
enclosure with pegs, top entry							MHVS 16.32	32
enclosure with pegs, top entry, high construction					CAVS 16.29	29	MAVS 16.32	32
enclosure with pegs, top entry, high construction							MAVS 16.40	40
cover with 2 levers (for enclosures with 4 pegs) ²⁾					CHCS 16 G			

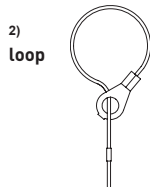
panel cut-out for bulkhead mounting housings



For fixing on housings



For fixing on hoods

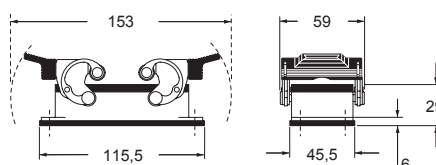


CALUS Type 4/4X/12

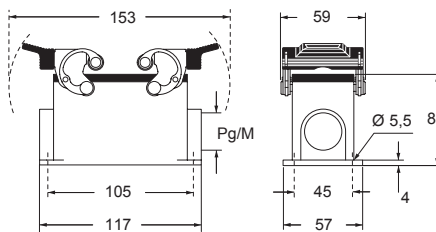
insulating cable gland or fittings without gasket

cable gland with O-Ring gasket

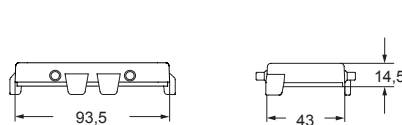
CHIS



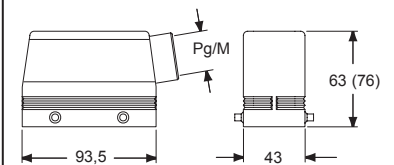
CAPS and MAPS



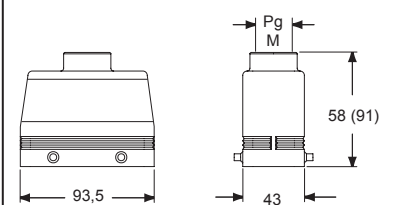
CHCS - CHCS S



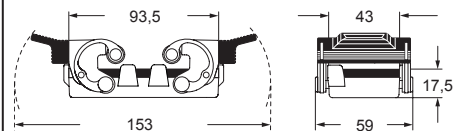
CHOS (CAOS) and MHOS (MAOS)



CHVS (CAVS) and MHVS (MAVS)



CHCS G

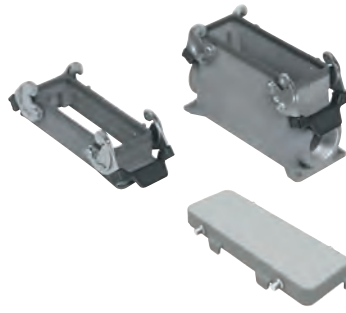


CH - CA and MH - MA EMC version for electromagnetic compatibility

inserts		page:
CD	64 poles + ⊕	72
CDD	108 poles + ⊕	81
CDS	42 poles + ⊕	-
CDSH	42 poles + ⊕	89
CNE	24 poles + ⊕	113
CSE	24 poles + ⊕	-
CSH	24 poles + ⊕	113
CSH S	24 poles + ⊕	125
CCE	24 poles + ⊕	133
CMSH	10+2 (aux) poles + ⊕	140
CMCE	10+2 (aux) poles + ⊕	141
CSS	24 poles + ⊕	151
CT, CTS (10A *)	64 poles + ⊕	157
CT, CTSE (16A *)	24 poles + ⊕	163
CQE	46 poles + ⊕	171
CQEE	64 poles + ⊕	177
CX	4/8 and 6/6 poles + ⊕	204 and 206
MIXO	6 modules	262 - 317

*) only for enclosure CHIS 24

housings and cover

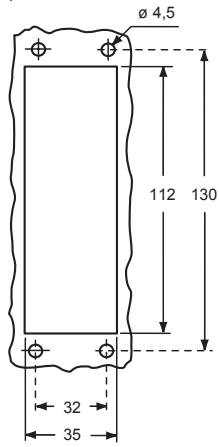


hoods and cover

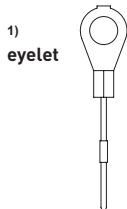


description	part No.	entry Pg	part No	entry M	part No.	entry Pg	part No.	entry M
bulkhead mounting housing with levers and gasket	CHIS 24	--						
surface mounting housing, with levers, high construction	CAPS 24.21	21	MAPS 24.32	32				
cover with 4 pegs (for enclosures with 2 levers) ¹⁾	CHCS 24							
cover with 4 pegs (for enclosures with 2 levers) ²⁾	CHCS 24 S							
enclosure with pegs, side entry					CHOS 24	21	MHOS 24.25	25
enclosure with pegs, side entry							MHOS 24.32	32
enclosure with pegs, side entry, high construction					CAOS 24.29	29	MAOS 24.32	32
enclosure with pegs, side entry, high construction							MAOS 24.40	40
enclosure with pegs, top entry					CHVS 24	21	MHVS 24.25	25
enclosure with pegs, top entry							MHVS 24.32	32
enclosure with pegs, top entry, high construction					CAVS 24.29	29	MAVS 24.32	32
enclosure with pegs, top entry, high construction							MAVS 24.40	40
cover with 2 levers (for enclosures with 4 pegs) ²⁾	CHCS 24 G							

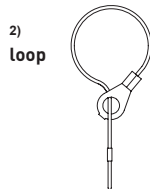
panel cut-out for bulkhead mounting housings



For fixing on housings



For fixing on hoods

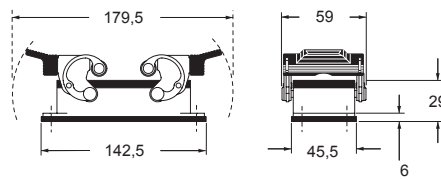


CAU® Type 4/4X/12

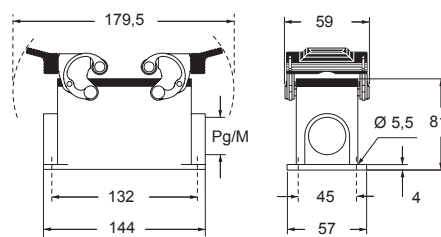
insulating cable gland or fittings without gasket

cable gland with O-Ring gasket

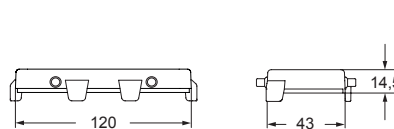
CHIS



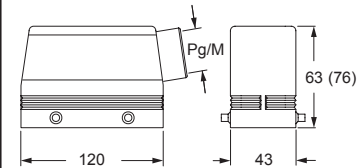
CAPS and MAPS



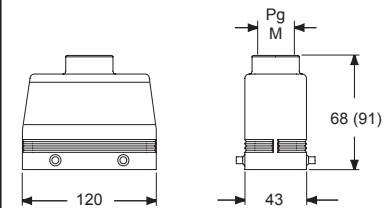
CHCS - CHCS S



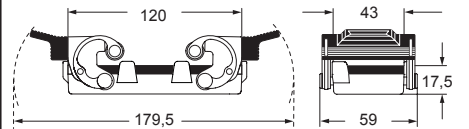
CHOS (CAOS) and MHOS (MAOS)



CHVS (CAVS) and MHVS (MAVS)



CHCS G



180 °C

The heat shield

Series specifically developed for industrial applications where the ambient temperatures are particularly harsh (from -40°C to +180°C). Available in the sizes "21.21", "44.27", "57.27", "77.27", "104.27" and "104.62", to be used in combination with the available connector inserts suitable for high temperatures up to **180 °C** made by self-extinguishing thermoplastic material (>PPS< polyphenylene sulphide). All these enclosures except those sized "21.21" have supplementary insulating strips inside.

This enclosure series is distinguished by the red colour.

✓ **cULus** certified for USA and Canada for **Type 12** (indoor use), **Type 4** and **Type 4X** (outdoor use) (equivalent to NEMA 12, 4, and 4X) protection ratings, marked on the packaging label. **IP44** (size "21.21"), **IP65** (other sizes) degree of protection according to **EN IEC 60529**.



SUM-UP OF MATERIALS USED

- ☑ Enclosure body made of die cast aluminium alloy
- ☑ Chromate conversion coating, RoHS 2 conform, on the enclosure body die casts
- ☑ Coated with special high temperatures resistant, red coloured thermosetting powder
- ☑ Flange and interface sealing gaskets (as applicable) in FKM, anti-aging heat resistant fluoroelastomer
- ☑ Locking device with lever(s), springs and pegs in stainless steel
- ☑ Single-block locking lever handles in stainless steel (for "21.21" sized CKA...R/ MKA...R, "44.16" sized CZ...R and MZ...R, and "104.62" sized CH...R 48 ... and, MH...R 48 ... versions)
- ☑ Locking lever handles in die-cast aluminium alloy with the same special coating as the enclosure body (for CH...R 10, 16, 24 and MH...R 10, 16, 24 versions)

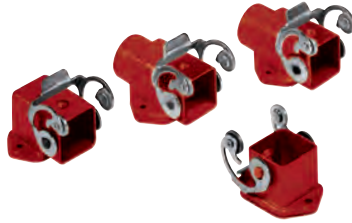


Watch our
180 °C enclosure
series video

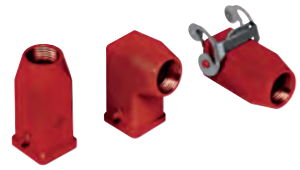
CKA and MKA 180 °C version

inserts		page:
CK RY	3 poles + ⊕	60
CK RY	4 poles + ⊕	60

bulkhead mounting housings straight and angled



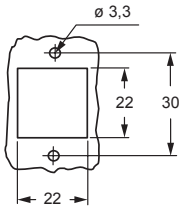
hoods



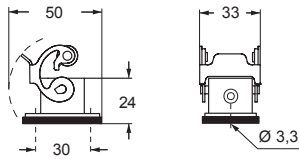
description	part No. (entry Pg 11)	part No. (entry M20)	part No. (entry Pg 11)	part No. (entry M20)
with stainless steel lever and gasket ¹⁾	CKAXR 03 I			
without cable entry, with stainless steel lever and gasket ¹⁾	CKAXR 03 IA			
with cable entry, with stainless steel lever and gasket ¹⁾	CKAXR 03 IAP	MKAXR IAP20		
with cable entry, with stainless steel lever and gasket bulkhead hole closed ¹⁾	CKAXR 03 AP	MKAXR AP20		
with pegs, top entry ¹⁾			CKAR 03 V	MKAR V20
with pegs, side entry ¹⁾			CKAR 03 VA	MKAR VA20
with stainless steel lever, top entry ¹⁾			CKAXR 03 VG	MKAXR VG20

¹⁾ Enclosures with IP44 protection rating

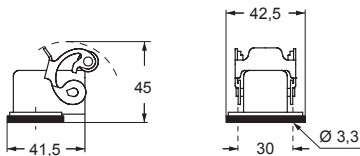
panel cut-out for bulkhead mounting housings



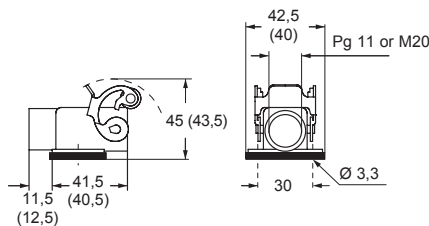
CKAXR I



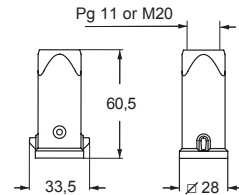
CKAXR IA



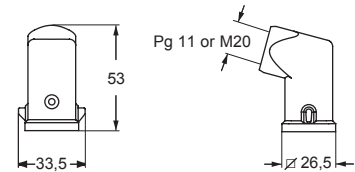
CKAXR IAP (CKAXR AP) and MKAXR IAP (MKAXR AP)



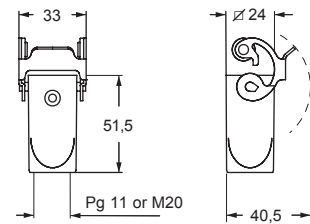
CKAR V and MKAR V



CKAR VA and MKAR VA



CKAXR VG and MKAXR



CAUS® Type 12



MKAX 180 °C version

inserts		page:
CK RY	3 poles + ⊕	60
CK RY	4 poles + ⊕	60

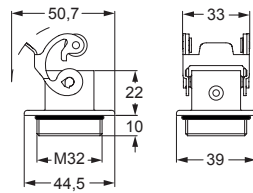
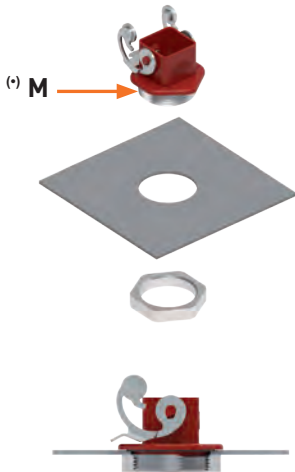
bulkhead mounting housings with stainless steel lever



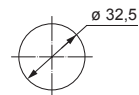
description	part No. (entry - M32)
-------------	---------------------------

M32 fixing thread ^(*) **MKAXR IF**

^(*) Locknut supplied on request, see Cable glands catalogue (article AS M32N metallic)



panel cut-out for enclosures



180 °C

CAUS® Type 12



MKAXX 180 °C version

inserts		page:
CK RY	3 poles + ⊕	60
CK RY	4 poles + ⊕	60

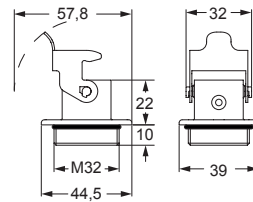
bulkhead mounting housings with stainless steel rigid lever



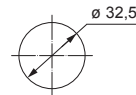
description	part No. (entry - M32)
-------------	---------------------------

M32 fixing thread ^(*) **MKAXXR IF**

^(*) Locknut supplied on request, see Cable glands catalogue (article AS M32N metallic)



panel cut-out for enclosures



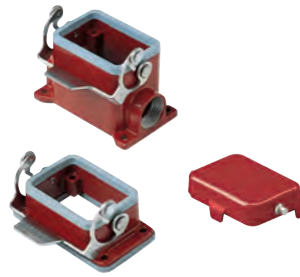
CAI[®]US Type 12



180 °C

inserts
CNE RY 6 poles + ⊕
 page: 116

bulkhead and surface mounting housings and cover



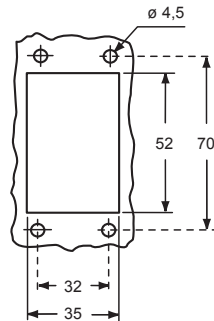
hoods and cover



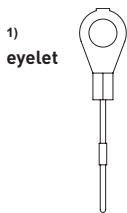
description	part No.	entry Pg	part No	entry M	part No.	entry Pg	part No.	entry M
bulkhead mounting housing with lever and gasket	CZIR 06 L	--						
surface mounting housing, with lever	CZPR 06 L	16	MZPR 06 L20	20				
surface mounting housing, with lever, high construction	CZAPR 06 L	21	MZAPR 06 L32	32				
cover with pegs (for enclosures) ¹⁾	CHCR 06 L							
cover with pegs (for enclosures) ²⁾	CHCR 06 SL							
enclosure with pegs, side entry					CHOR 06 L13	13,5	MHOR 06 L20	20
enclosure with pegs, side entry, high construction					CAOR 06 L21	21	MAOR 06 L32	32
enclosure with pegs, top entry					CHVR 06 L13	13,5		
enclosure with pegs, top entry ³⁾							MHVR 06 L20	20
enclosure with pegs, top entry, high construction					CAVR 06 L21	21	MAVR 06 L32	32
cover with lever (for hoods) ²⁾					CZCR 06 LG			

³⁾ can only be used with a complete cable gland (to be purchased separately)

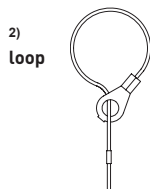
panel cut-out for bulkhead mounting housings



For fixing on housings



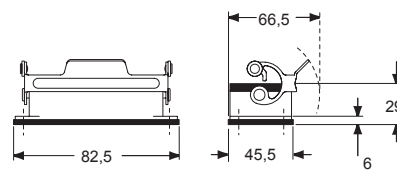
For fixing on hoods



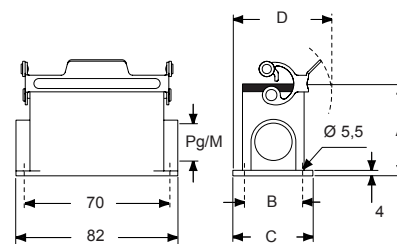
CAIUS Type 4/4X/12



CZIR L



CZPR L - CZAPR L and MZPR L - MZAPR L

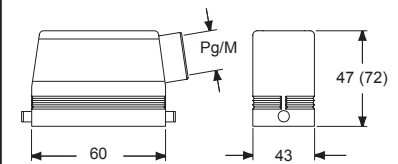


type	A	B	C	D
CZPR L / MZPR L	53	40	52	69,5
CZAPR L / MZAPR L	74	45	57	72

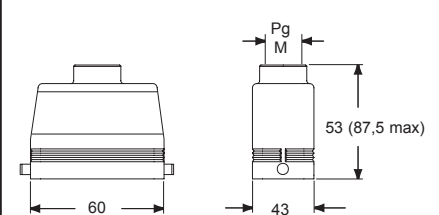
CHCR L - CHCR SL



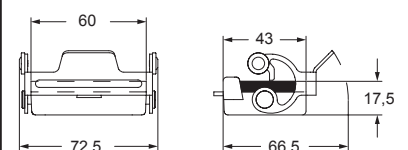
CHOR L (CAOR L) and MHOR L (MAOR L)



CHVR L (CAVR L) and MHVR L (MAVR L)



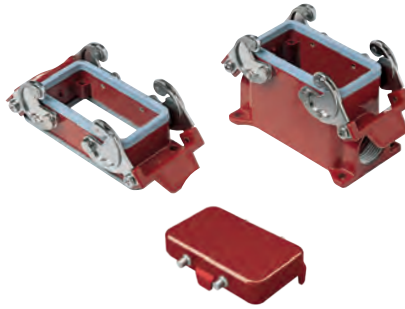
CZCR LG



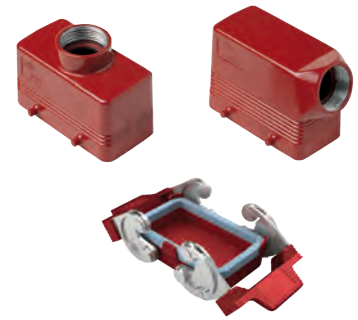
CH - CA and MH - MA 180 °C version

inserts
CNE RY 10 poles + ⊕ page: 117

bulkhead and surface mounting housings and cover



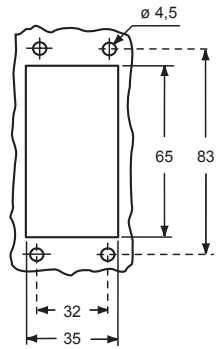
hoods and cover



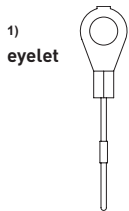
description	part No.	entry Pg	part No.	entry M	part No.	entry Pg	part No.	entry M
bulkhead mounting housing with levers and gasket	CHIR 10	–						
surface mounting housing, with levers	CHPR 10	16	MHPR 10.20	20				
surface mounting housing, with levers, high construction	CAPR 10.21	21	MAPR 10.32	32				
cover with 4 pegs (for enclosures) ¹⁾	CHCR 10							
cover with 4 pegs (for enclosures) ²⁾	CHCR 10 S							
enclosure with pegs, side entry					CHOR 10	16	MHOR 10.20	20
enclosure with pegs, side entry, high construction					CAOR 10.21	21	MAOR 10.32	32
enclosure with pegs, top entry					CHVR 10	16		
enclosure with pegs, top entry ³⁾							MHVR 10.20	20
enclosure with pegs, top entry, high construction					CAVR 10.21	21	MAVR 10.32	32
cover with 2 levers (for hoods) ²⁾					CHCR 10 G			

³⁾ can only be used with a complete cable gland (to be purchased separately)

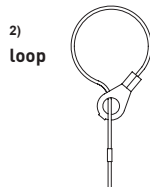
panel cut-out for bulkhead mounting housings



For fixing on housings



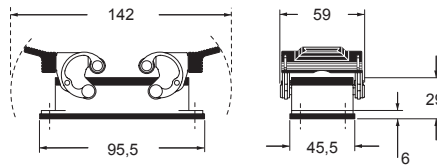
For fixing on hoods



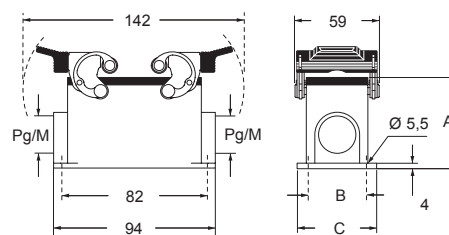
CAI[®] US Type 4/4X/12



CHIR



CHPR - CAPR and MHPR - MAPR

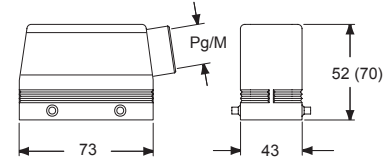


type	A	B	C
CHPR / MHPR	57	40	52
CAPR / MAPR	74	45	57

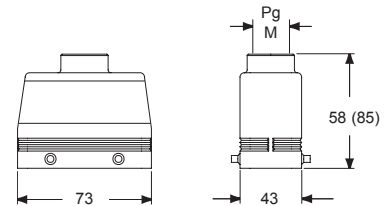
CHCR - CHCR S



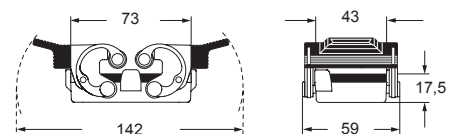
CHOR (CAOR) and MHOR (MAOR)



CHVR (CAVR) and MHVR³⁾ (MAVR)



CHCR G



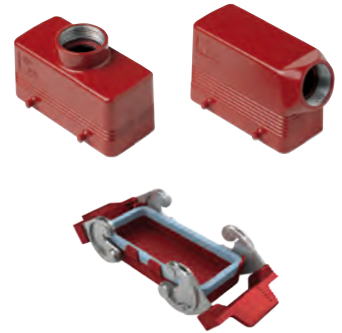
CH - CA and MH - MA 180 °C version

inserts		page:
CNE RY	16 poles + ⊕	118
CP RY	6 poles + ⊕	178
CX RY	4/0 and 4/2 poles + ⊕	202 - 203

bulkhead and surface mounting housings and cover

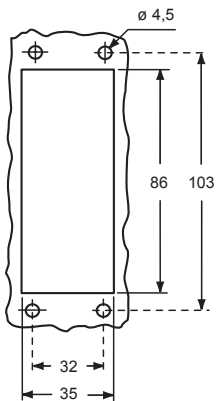


hoods and cover

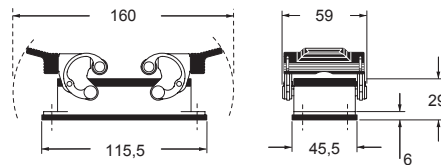


description	part No.		part No.		part No.		part No.	
	entry Pg	entry M	entry Pg	entry M	entry Pg	entry M	entry Pg	entry M
bulkhead mounting housing with levers and gasket								
surface mounting housing, with levers, high construction								
cover with 4 pegs (for enclosures) ¹⁾								
cover with 4 pegs (for enclosures) ²⁾								
enclosure with pegs, side entry								
enclosure with pegs, side entry, high construction								
enclosure with pegs, top entry								
enclosure with pegs, top entry, high construction								
cover with 2 levers (for hoods) ²⁾								

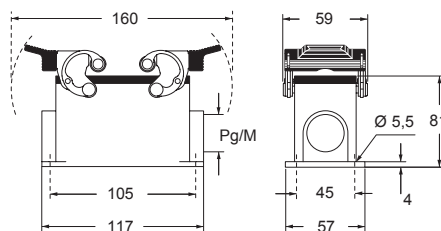
panel cut-out for bulkhead mounting housings



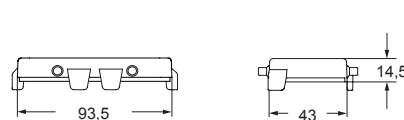
CHIR



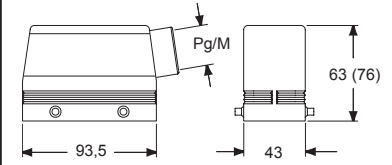
CAPR and MAPR



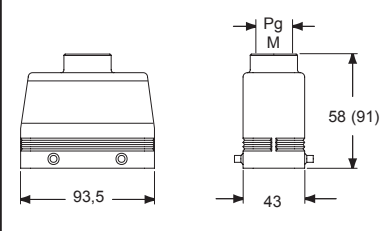
CHCR - CHCR S



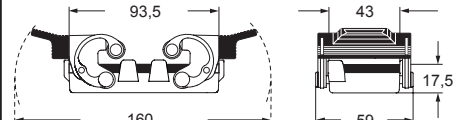
CHOR (CAOR) and MHOR (MAOR)



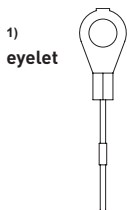
CHVR (CAVR) and MHVR (MAVR)



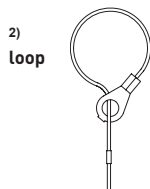
CHCR G



For fixing on housings



For fixing on hoods



CAIUS Type 4/4X/12



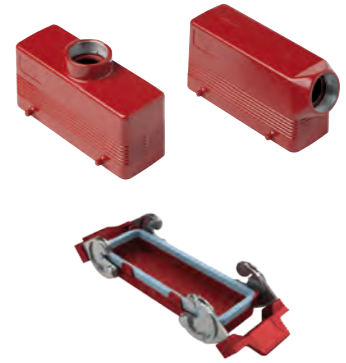
CH - CA and MH - MA 180 °C version

inserts		page:
CNE RY	24 poles + ⊕	119
CX RY	4/8 poles + ⊕	204

bulkhead and surface mounting housings and cover

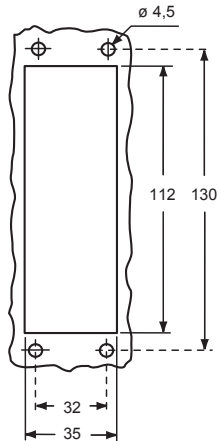


hoods and cover

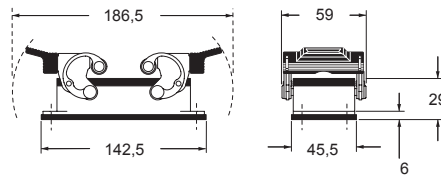


description	part No.	entry Pg	part No.	entry M	part No.	entry Pg	part No.	entry M
bulkhead mounting housing with levers and gasket	CHIR 24	--						
surface mounting housing, with levers, high construction	CAPR 24.21	21	MAPR 24.32	32				
cover with 4 pegs (for enclosures) ¹⁾	CHCR 24							
cover with 4 pegs (for enclosures) ²⁾	CHCR 24 S							
enclosure with pegs, side entry	CHOR 24	21	MHOR 24.25	25				
enclosure with pegs, side entry, high construction	CAOR 24.29	29	MAOR 24.40	40				
enclosure with pegs, top entry	CHVR 24	21	MHVR 24.25	25				
enclosure with pegs, top entry, high construction	CAVR 24.29	29	MAVR 24.40	40				
cover with 2 levers (for hoods) ²⁾	CHCR 24 G							

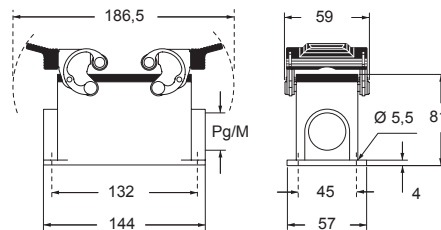
panel cut-out for bulkhead mounting housings



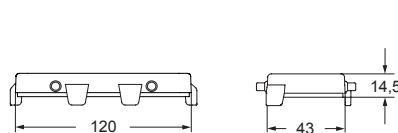
CHIR



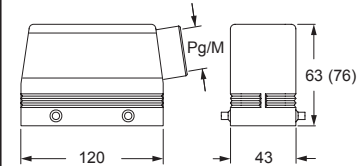
CAPR and MAPR



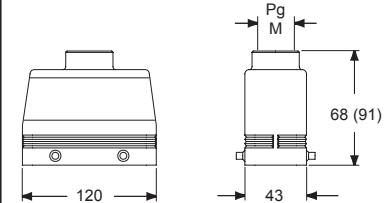
CHCR - CHCR S



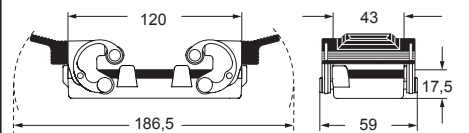
CHOR (CAOR) and MHOR (MAOR)



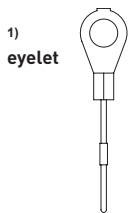
CHVR (CAVR) and MHVR (MAVR)



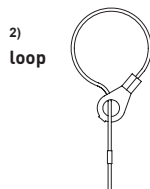
CHCR G



For fixing on housings



For fixing on hoods



CAUS® Type 4/4X/12



CH and MH 180 °C version

inserts page:
CNE RY 48 poles + ⊕ 120

insert dimensions:
2 x (104 x 27) mm

bulkhead and surface mounting housings

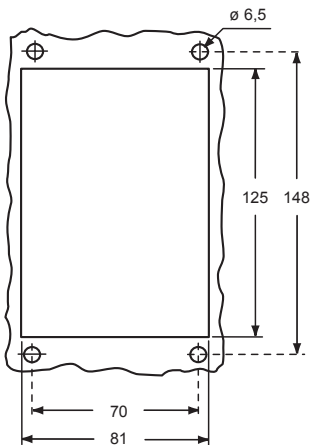


hoods

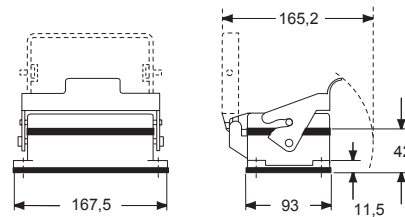


description	part No.	entry Pg	part No.	entry M	part No.	entry Pg	part No.	entry M
bulkhead mounting housings, with lever and cover	CHIR 48 LS	--						
surface mounting housings, with lever and cover	CHPR 48 LS	36 x 1/2	MHPR 48 LS40	40 x 1/2				
side entry, with pegs					CHOR 48 L	36	MHOR 48 L40	40
top entry, with pegs					CHVR 48 L	36	MHVR 48 L40	40

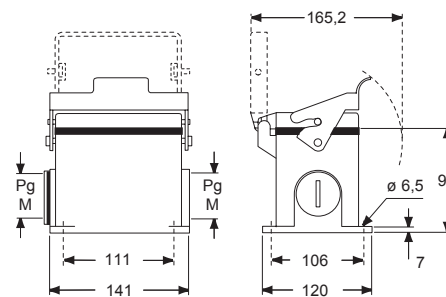
panel cut-out for bulkhead mounting housings



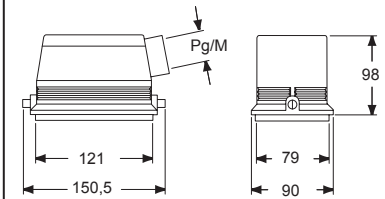
CHIR LS



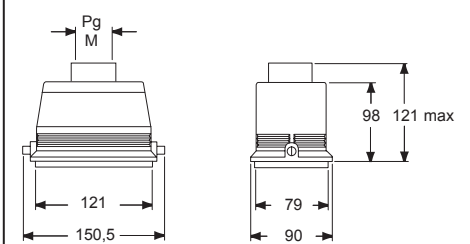
CHPR LS and MHPR LS



CHOR L and MHOR L



CHVR L and MHVR L



CAUS® Type 4/4X/12



180 °C

HNM series

In and out

Housings (bulkhead-mount or surface mount) equipped with **V-TYPE single locking lever** with special **anti-friction treatment**

to be mated to

Hoods with **riveted anti-friction pegs**, that facilitate the frequent opening and closing.

This **HNM** series of connector enclosures has been developed to be used in combination with the **HNM** series of multipole connector inserts equipped with relevant **HNM** series of removable crimp contacts, to provide the same reliable protection of the standard series but for a consistently extended, **high number of matings**.

When the number of 500 mating cycles guaranteed life of standard connector hoods and housings is insufficient to provide a reasonably long life span in those connector applications that by function are foreseen to be subject to very frequent connections and disconnections, it is necessary to opt for a solution able to increase that guaranteed lifetime.

The **HNM** series of connector enclosures achieves this goal, extending the guaranteed number of matings up to 10.000.

The locking means, comprising both the locking lever and locking pegs are chosen and treated so as to reduce wear due to friction at minimum, thanks to the use of the clever proprietary design of the **V-TYPE locking lever**, that already in standard enclosures is able to provide extremely reduced wear on the corresponding locking pegs, producing a very limited friction, furtherly reduced by the application of a special anti-friction lubrication treatment.

The counterpart hoods for locking on the long side are already provided by riveted anti-friction rolling pegs, as well furtherly improved by the special anti-friction lubrication treatment.



RV - RVA HNM (High Number of Matings)

inserts		page:
RDD	24 poles + ⊕	210
RCE	6 poles + ⊕	214
MIXO HNM	2 modules	321 - 333

bulkhead mounting housings
with single lever in stainless steel



Q 10.000 MATINGS WITH HNM INSERTS

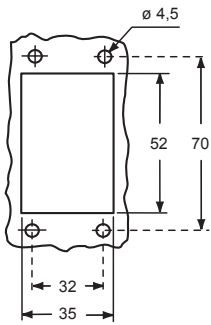
surface mounting housings
with single lever in stainless steel



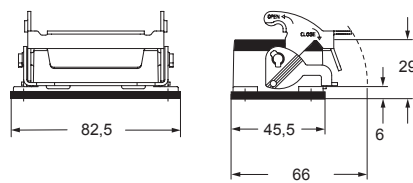
Q 10.000 MATINGS WITH HNM INSERTS

description	part No.	part No.	entry M
with lever and gasket, size "44.27"	RVI 06 L		
with lever, size "44.27"		RVP 06 L20	20
with lever, size "44.27"		RVP 06 L220	20 x 2
with lever, high construction, size "44.27"		RVAP 06 L32	32
with lever, high construction, size "44.27"		RVAP 06 L232	32 x 2

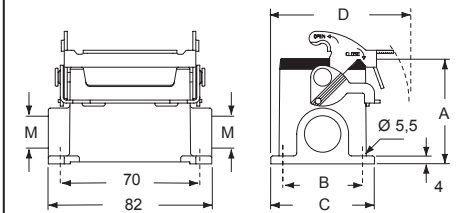
panel cut-out for bulkhead mounting housings



RVI L



RVP L - RVAP L



type	A	B	C	D
RVP 06 L	53	40	52	70
RVAP 06 L	74	45	57	72,5

CAVUS® Type 4/4X/12



insulating cable gland or fittings
without gasket



cable gland
with O-Ring gasket

RH - RF HNM (High Number of Matings)

inserts		page:
RDD	24 poles + ⊕	210
RCE	6 poles + ⊕	214
MIXO HNM	2 modules	321 - 333

hoods with 2 pegs



Q 10.000 MATINGS WITH HNM INSERTS

hoods with 2 pegs

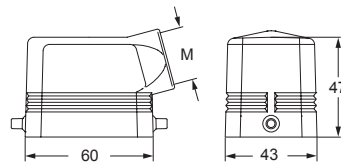


Q 10.000 MATINGS WITH HNM INSERTS

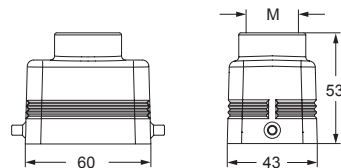
description	part No.	entry M	part No.	entry M
with pegs, side entry	RHO 06 L25	25	RFO 06 L32	32
with pegs, top entry ¹⁾	RHV 06 L25	25	RFV 06 L32	32
with pegs, side entry, high construction, without adapter ²⁾				
with pegs, top entry, high construction, without adapter ²⁾				

¹⁾ cannot be used with MIXO series.
²⁾ enclosure without adapter, threaded on the body, to be used only with a complete cable gland.

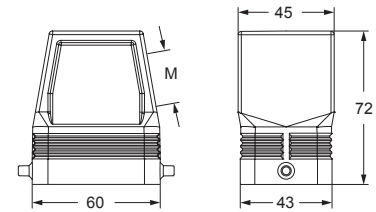
RHO L



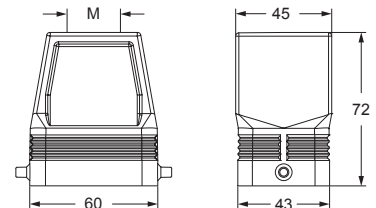
RHV L



RFO L



RFV L



CAVUS® Type 4/4X/12

insulating cable gland or fittings without gasket

cable gland with O-Ring gasket

RV - RVA HNM (High Number of Matings)

inserts		page:
RDD	42 poles + ⊕	211
RCE	10 poles + ⊕	215
MIXO HNM	3 modules	321 - 333

bulkhead mounting housings with single lever in stainless steel



Q 10.000 MATINGS WITH HNM INSERTS

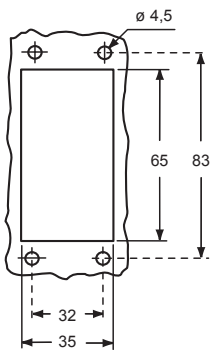
surface mounting housings with single lever in stainless steel



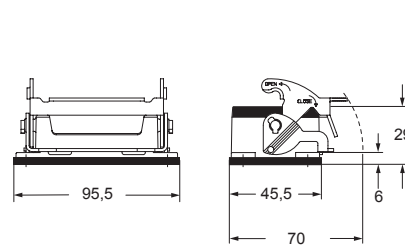
Q 10.000 MATINGS WITH HNM INSERTS

description	part No.	part No.	entry M
with lever, size "57.27"	RVI 10 L		
with lever, size "57.27"		RVP 10 L20	20
with lever, size "57.27"		RVP 10 L220	20 x 2
with lever, high construction, size "57.27"		RVAP 10 L32	32
with lever, high construction, size "57.27"		RVAP 10 L232	32 x 2

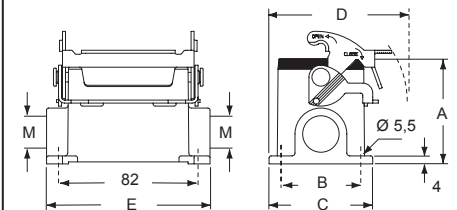
panel cut-out for bulkhead mounting housings



RVI L



RVP L - RVAP L



type	A	B	C	D	E
RVP 10 L	57	40	52	73	93,5
RVAP 10 L	74	45	57	75,5	94

CAU[®] US Type 4/4X/12



insulating cable gland or fittings
without gasket



cable gland
with O-Ring gasket

RH - RF HNM (High Number of Matings)

inserts		page:
RDD	42 poles + ⊕	211
RCE	10 poles + ⊕	215
MIXO HNM	3 modules	321 - 333

hoods with 2 pegs



Q 10.000 MATINGS WITH HNM INSERTS

hoods with 2 pegs

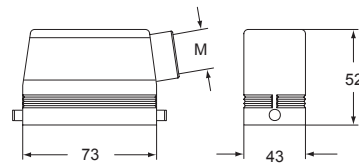


Q 10.000 MATINGS WITH HNM INSERTS

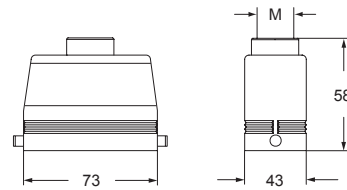
description	part No.	entry M	part No.	entry M
with pegs, side entry	RHO 10 L25	25	RFO 10 L32	32
with pegs, top entry	RHV 10 L25	25	RFV 10 L32	32
with pegs, side entry, high construction, without adapter ¹⁾				
with pegs, top entry, high construction, without adapter ¹⁾				

¹⁾ enclosure without adapter, threaded on the body, to be used only with a complete cable gland.

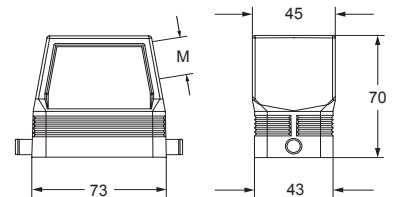
RHO L



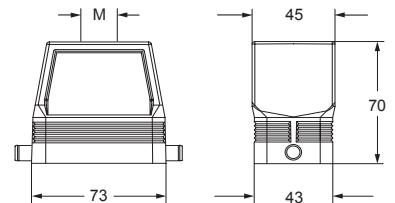
RHV L



RFO L



RFV L



CAVUS® Type 4/4X/12

insulating cable gland or fittings without gasket

cable gland with O-Ring gasket

RV - RVA HNM (High Number of Matings)

inserts		page:
RD	40 poles + ⊕	208
RDD	72 poles + ⊕	212
RCE	16 poles + ⊕	216
RQEE	40 poles + ⊕	218
RX	12 poles + 2 poles + ⊕	221
MIXO HNM	4 modules	321 - 333

bulkhead mounting housings with single lever in stainless steel



Q 10.000 MATINGS WITH HNM INSERTS

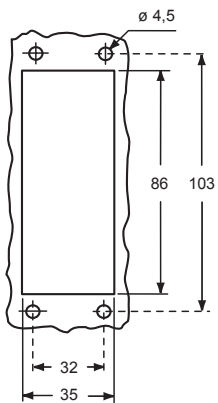
surface mounting housings with single lever in stainless steel



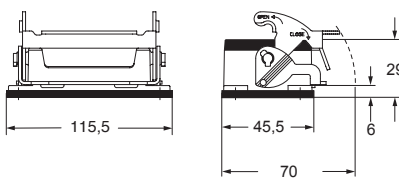
Q 10.000 MATINGS WITH HNM INSERTS

description	part No.	part No.	entry M
with lever, size "77.27"	RVI 16 L		
with lever, size "77.27"		RVP 16 L25	25
with lever, size "77.27"		RVP 16 L225	25 x 2
with lever, high construction, size "77.27"		RVAP 16 L32	32
with lever, high construction, size "77.27"		RVAP 16 L232	32 x 2

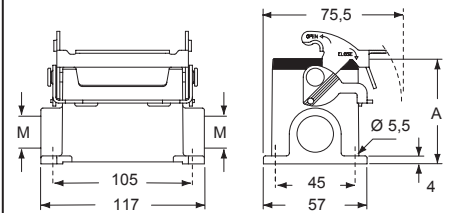
panel cut-out for bulkhead mounting housings



RVI L





RVP L - RVAP L



type	A
RVP 16 L	63
RVAP 16 L	81

CAVUS® Type 4/4X/12

 insulating cable gland or fittings without gasket

 cable gland with O-Ring gasket

RH - RF HNM (High Number of Matings)

inserts		page:
RD	40 poles + ⊕	208
RDD	72 poles + ⊕	212
RCE	16 poles + ⊕	216
RQEE	40 poles + ⊕	218
RX	12 poles + 2 poles + ⊕	221
MIXO HNM	4 modules	321 - 333

hoods with 2 pegs



Q 10.000 MATINGS WITH HNM INSERTS

hoods with 2 pegs

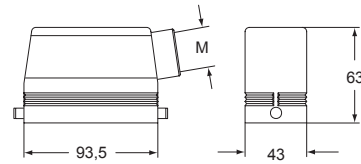


Q 10.000 MATINGS WITH HNM INSERTS

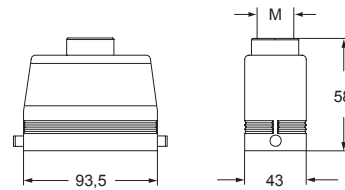
description	part No.	entry M	part No.	entry M
with pegs, side entry	RHO 16 L32	32	RFO 16 L32	32
with pegs, top entry	RHV 16 L32	32	RFV 16 L32	32
with pegs, side entry, high construction, without adapter ¹⁾				
with pegs, top entry, high construction, without adapter ¹⁾				

¹⁾ enclosure without adapter, threaded on the body, to be used only with a complete cable gland.

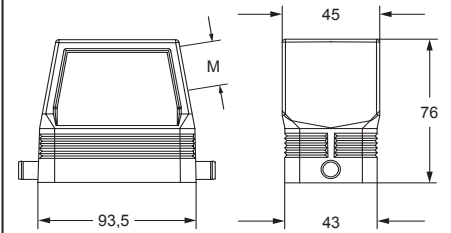
RHO L



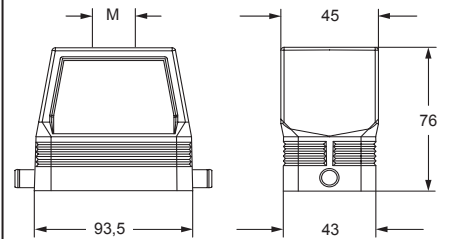
RHV L



RFO L



RFV L



CAVUS® Type 4/4X/12

insulating cable gland or fittings without gasket

cable gland with O-Ring gasket

RV - RVA HNM (High Number of Matings)

inserts		page:
RD	64 poles + ⊕	209
RDD	108 poles + ⊕	213
RCE	24 poles + ⊕	217
RQEE	64 poles + ⊕	219
MIXO HNM	6 modules	321 - 333

bulkhead mounting housings with single lever in stainless steel



Q 10.000 MATINGS WITH HNM INSERTS

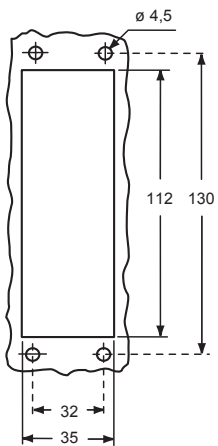
surface mounting housings with single lever in stainless steel



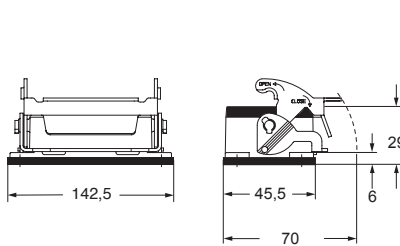
Q 10.000 MATINGS WITH HNM INSERTS

description	part No.	part No.	entry M
with lever, size "104.27"	RVI 24 L		
with lever, size "104.27"		RVP 24 L25	25
with lever, size "104.27"		RVP 24 L225	25 x 2
with lever, high construction, size "104.27"		RVAP 24 L32	32
with lever, high construction, size "104.27"		RVAP 24 L232	32 x 2

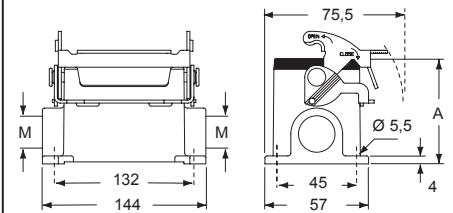
panel cut-out for bulkhead mounting housings



RVI L



RVP L - RVAP L



type	A
RVP 24 L	63
RVAP 24 L	81

CAVUS® Type 4/4X/12



insulating cable gland or fittings without gasket



cable gland with O-Ring gasket

RH - RF HNM (High Number of Matings)

inserts		page:
RD	64 poles + ⊕	209
RDD	108 poles + ⊕	213
RCE	24 poles + ⊕	217
RQEE	64 poles + ⊕	219
MIXO HNM	6 modules	321 - 333

hoods with 2 pegs



Q 10.000 MATINGS WITH HNM INSERTS

hoods with 2 pegs

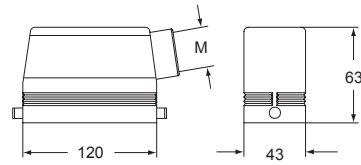


Q 10.000 MATINGS WITH HNM INSERTS

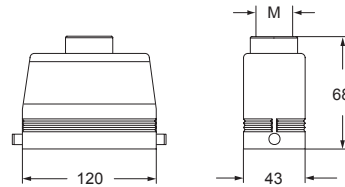
description	part No.	entry M	part No.	entry M
with pegs, side entry	RHO 24 L32	32	RFO 24 L40	40
with pegs, top entry	RHV 24 L32	32	RFV 24 L40	40
with pegs, side entry, high construction, without adapter ¹⁾				
with pegs, top entry, high construction, without adapter ¹⁾				

¹⁾ enclosure without adapter, threaded on the body, to be used only with a complete cable gland.

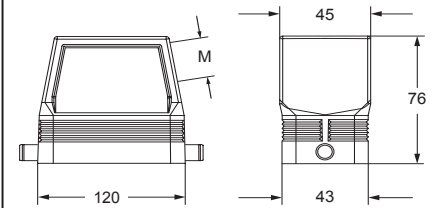
RHO L



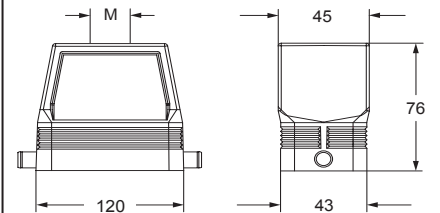
RHV L



RFO L



RFV L



CAVUS® Type 4/4X/12

insulating cable gland or fittings without gasket

cable gland with O-Ring gasket

RAC dummy hoods HNM (High Number of Matings)

enclosures

size "44.27"
size "57.27"
size "77.27"
size "104.27"

page:

592 - 593
594 - 595
596 - 597
598 - 599

hoods without entry, to be pierced



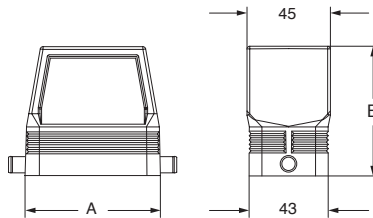
Q 10.000 MATINGS WITH HNM INSERTS

description

part No.
with 2 pegs

with pegs for levers
used with enclosures size "44.27"
used with enclosures size "57.27"
used with enclosures size "77.27"
used with enclosures size "104.27"

RAC 06 L
RAC 10 L
RAC 16 L
RAC 24 L



part No.	A	B
RAC 06 L	60	72
RAC 10 L	73	70
RAC 16 L	93,5	76
RAC 24 L	120	76

CAUS® Type 4/4X/12



insulating cable gland or fittings
without gasket



cable gland
with O-Ring gasket

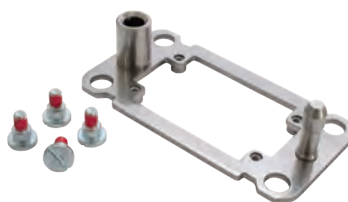
CR...DF self-centring floating frame HNM (High Number of Matings)

Q CAUTION: As the frames are floating, the **PE earthing connection of the metal surfaces on which they are mounted** (mounting bases) **must be performed separately** and cannot be done by connecting the PE earthing contact to the corresponding connector inserts.

NOTE: The supply includes 1 frame and 4 shoulder screws with cylindrical head and notch to fix the frame in place.

For use with MIXO inserts CX 04 X, please contact ILME S.p.A.

self-centring floating frame



Q 10.000 MATINGS WITH HNM INSERTS

description	part No.
-------------	----------

in stainless steel, to be mounted on:
 inserts size "44.27"¹⁾ and MIXO frames for 2 inserts
 inserts size "57.27"¹⁾ and MIXO frames for 3 inserts
 inserts size "77.27"¹⁾ and MIXO frames for 4 inserts
 inserts size "104.27"¹⁾ and MIXO frames for 6 inserts

- CR 06 DF**
- CR 10 DF**
- CR 16 DF**
- CR 24 DF**

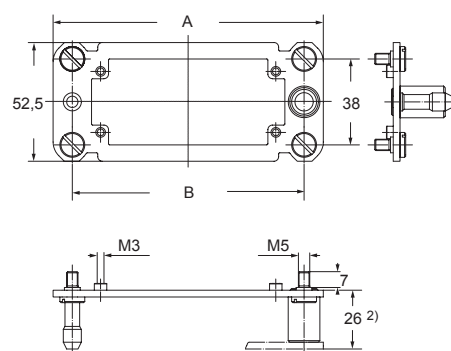
¹⁾ Except CT, CTS and CTSE

Technical specifications

- materials:
 - floating frame, inserts: stainless steel
 - fixing screws: zinc-plated steel
- mechanical endurance: up to 10.000 cycles with HNM inserts
- compensation range:
 - x axis: ± 1,5 mm
 - y axis: ± 1,5 mm

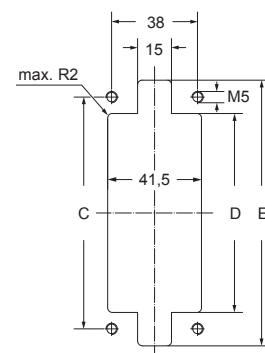
Characteristics

- Suitable, depending on size, for all standard and MIXO connector inserts and frames, except series CT, CTS and CTSE.
- Designed to be used in the transportation, printing and power electronic industries (for example boxes for rack cabinets) and in all industrial applications that require, during assembly or maintenance, the connection of connectors without possibility of controlling the alignment.
- Enables the **self-centring coupling of two corresponding** connectors without the use of enclosures; they freely move on their base plate (± 1,5 mm on both axes) ensuring the **alignment of the coupling**.

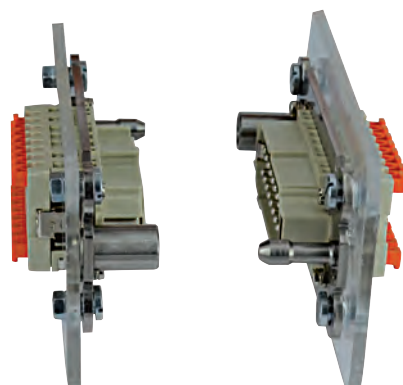


²⁾ distance for electric and fibre optic contacts: max 27 mm;
 distance for pneumatic contacts: max 26,5 mm.

panel cut-out



part No.	A	B	C	D	E
CR 06 DF	86	69	69	54,5	84
CR 10 DF	99	82	82	67,5	97
CR 16 DF	119,5	102,5	102,5	88	117,5
CR 24 DF	146	129	129	114,5	144



CENTRAL LEVER series

Easy access for robotics

Series specifically designed for industrial applications with limited installation space.

These enclosures can be installed, placed side-by-side and handled in a single operation.

Furthermore, the lever's shape reduces the effort required to uncouple the inner fittings.

SUM-UP OF MATERIALS USED FOR CH..YC, CA..YC and MA..YC, CA..YX and MF..YX series

- ☐ **Made of die cast aluminium alloy**
- ☐ **With epoxy-polyester powder coating**
- ☐ **Gaskets in anti-aging, oil-resistant, grease-resistant and fuel-resistant vinyl nitrile elastomer**
- ☐ **Locking device with single stainless steel lever**



CH - CA and MA CENTRAL LEVER

inserts		page:
CDD	42 poles + ⊕	78
CDS	18 poles + ⊕	-
CDSH	18 poles + ⊕	87
CNE	10 poles + ⊕	111
CSE	10 poles + ⊕	-
CSH	10 poles + ⊕	111
CSH S	10 poles + ⊕	123
CCE	10 poles + ⊕	131
CSS	10 poles + ⊕	149
CT, CTSE (16A) *)	18 poles + ⊕	161
CQE	18 poles + ⊕	169
MIXO	3 modules	262 - 317

*) can be used only in bulkhead mounting housings

bulkhead mounting housings for central lever

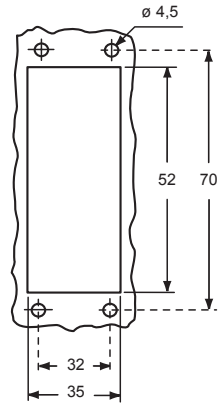


surface mounting housings, with two entries for central lever



description	part No.	part No.	entry Pg	part No.	entry M
bulkhead mounting with pegs	CHI 06 YC				
surface mounting, high construction, with pegs		CAP 06 YC229	29x2	MAP 06 YC232	32x2

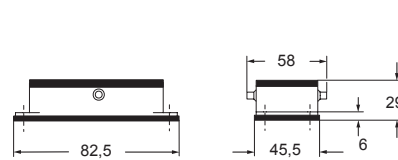
panel cut-out for bulkhead mounting housings



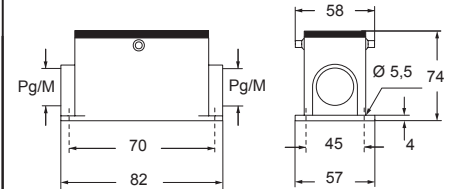
Even when coding is not required, it is recommended to use CRM and CRF pins with CD and CDD inserts and CRM CX and CRF CX pins with MIXO inserts to reduce movements when fitting and removing the connectors and to avoid contact damages.

Within this scope, the EN 175301-801 standard (former DIN 43 652) requires a maximum angular fluctuation of $\pm 5^\circ$ on the long side, $\pm 2^\circ$ on the short side.

CHI YC



CAP YC and MAP YC



CAU[®] US Type 4/4X/12



CA and MA CENTRAL LEVER

inserts		page:
CDD	42 poles + ⊕	78
CDS	18 poles + ⊕	-
CDSH	18 poles + ⊕	87
CNE	10 poles + ⊕	111
CSE	10 poles + ⊕	-
CSH	10 poles + ⊕	111
CSH S	10 poles + ⊕	123
CCE	10 poles + ⊕	131
CSS	10 poles + ⊕	149
CQE	18 poles + ⊕	169
MIXO	3 modules	262 - 317

hoods with central lever



hoods with central lever

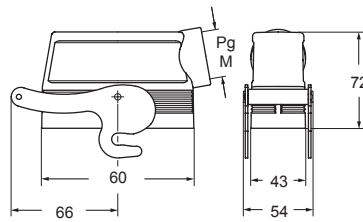


description	part No.		entry		part No.		entry	
			Pg	M			Pg	M
side entry, high construction	CAO 06 YX21	21	MAO 06 YX25	25				
side entry, high construction	CAO 06 YX29	29	MAO 06 YX32	32				
top entry, high construction					CAV 06 YX21	21	MAV 06 YX25	25
top entry, high construction					CAV 06 YX29	29	MAV 06 YX32	32

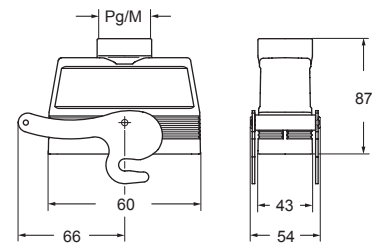
☑ Even when coding is not required, it is recommended to use CRM and CRF pins with CD and CDD inserts and CRM CX and CRF CX pins with MIXO inserts to reduce movements when fitting and removing the connectors and to avoid contact damages.

Within this scope, the EN 175301-801 standard (former DIN 43 652) requires a maximum angular fluctuation of $\pm 5^\circ$ on the long side, $\pm 2^\circ$ on the short side.

CAO..YX and MAO..YX



CAV..YX and MAV..YX



CAU[®]US Type 4/4X/12



CA - MA and CF - MF CENTRAL LEVER

inserts		page:
CDD	42 poles + ⊕	78
CDS	18 poles + ⊕	-
CDSH	18 poles + ⊕	87
CNE	10 poles + ⊕	111
CSE	10 poles + ⊕	-
CSH	10 poles + ⊕	111
CSH S	10 poles + ⊕	123
CCE	10 poles + ⊕	131
CSS	10 poles + ⊕	149
CQE	18 poles + ⊕	169
MIXO	3 modules	262 - 317

hoods for central lever



hoods for central lever



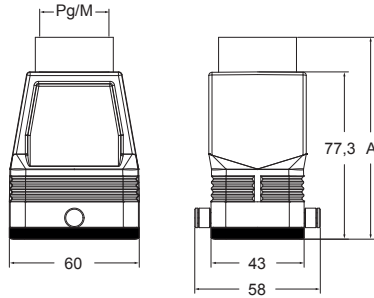
description	part No.	entry Pg	part No.	entry M	part No.	entry Pg	part No.	entry M
with pegs, top entry, high construction	CAV 06 GYC21	21	MAV 06 GYC25	25				
with pegs, top entry, high construction	CAV 06 GYC29	29	MAV 06 GYC32	32				
with pegs, top entry, high construction			MAV 06 GYC40	40				
with pegs, top entry, high construction, without adapter ¹⁾					CFV 06 GYC21	21	MFV 06 GYC25	25
with pegs, top entry, high construction, without adapter ¹⁾					CFV 06 GYC29	29	MFV 06 GYC32	32
with pegs, top entry, high construction, without adapter ¹⁾							MFV 06 GYC40	40

¹⁾ enclosure without adapter, threaded on the body, to be used only with a complete cable gland.

Even when coding is not required, it is recommended to use CRM and CRF pins with CD and CDD inserts and CRM CX and CRF CX pins with MIXO inserts to reduce movements when fitting and removing the connectors and to avoid contact damages.

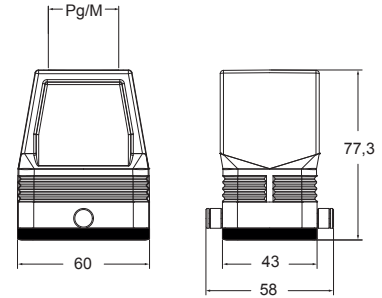
Within this scope, the EN 175301-801 standard (former DIN 43 652) requires a maximum angular fluctuation of ±5° on the long side, ±2° on the short side.

CAV..GYC and MAV..GYC



part No.	A
CAV 06 GYC21	92,3
CAV 06 GYC29	93,8
MAV 06 GYC25	92,3
MAV 06 GYC32	93,3
MAV 06 GYC40	96,3

CFV..GYC and MFV..GYC



CAIUS® Type 4/4X/12



CH - CA and MA CENTRAL LEVER

inserts		page:
CDD	42 poles + ⊕	78
CDS	18 poles + ⊕	-
CDSH	18 poles + ⊕	87
CNE	10 poles + ⊕	111
CSE	10 poles + ⊕	-
CSH	10 poles + ⊕	111
CSH S	10 poles + ⊕	123
CCE	10 poles + ⊕	131
CMSH	3+2 (aux) poles + ⊕	136
CMCE	3+2 (aux) poles + ⊕	137
CSS	10 poles + ⊕	149
CT, CTSE (16A) *	10 poles + ⊕	161
CQE	18 poles + ⊕	169
CX	8/24 poles + ⊕	194
MIXO	3 modules	262 - 317

*) can be used only in bulkhead mounting housings

bulkhead mounting housings for central lever

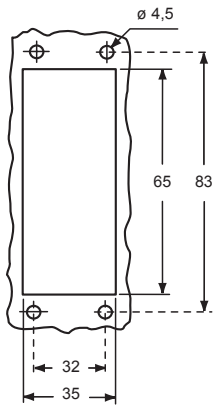


surface mounting housings, with two entries, for central lever

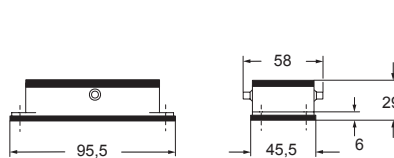


description	part No.	part No.	entry Pg	part No.	entry M
bulkhead mounting with pegs	CHI 10 YC				
surface mounting, high construction, with pegs		CAP 10 YC229	29x2	MAP 10 YC232	32x2

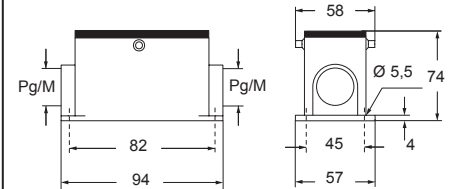
panel cut-out for bulkhead mounting housings



CHI YC



CAP YC and MAP YC



☑ Even when coding is not required, it is recommended to use CRM and CRF pins with CD and CDD inserts and CRM CX and CRF CX pins with MIXO inserts to reduce movements when fitting and removing the connectors and to avoid contact damages.

Within this scope, the EN 175301-801 standard (former DIN 43 652) requires a maximum angular fluctuation of $\pm 5^\circ$ on the long side, $\pm 2^\circ$ on the short side.

CAIUS Type 4/4X/12



CA and MA CENTRAL LEVER

inserts		page:
CDD	42 poles + ⊕	78
CDS	18 poles + ⊕	-
CDSH	18 poles + ⊕	87
CNE	10 poles + ⊕	111
CSE	10 poles + ⊕	-
CSH	10 poles + ⊕	111
CSH S	10 poles + ⊕	123
CCE	10 poles + ⊕	131
CMSH	3+2 (aux) poles + ⊕	136
CMCE	3+2 (aux) poles + ⊕	137
CSS	10 poles + ⊕	149
CQE	18 poles + ⊕	169
CX	8/24 poles + ⊕	194
MIXO	3 modules	262 - 317

hoods with central lever



hoods with central lever

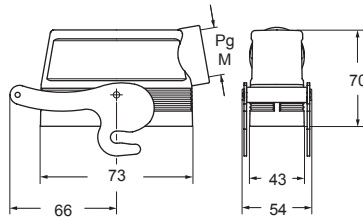


description	part No.	entry Pg	part No.	entry M	part No.	entry Pg	part No.	entry M
side entry, high construction	CAO 10 YX21	21	MAO 10 YX32	32				
side entry, high construction	CAO 10 YX29	29	MAO 10 YX40	40				
top entry, high construction					CAV 10 YX21	21	MAV 10 YX32	32
top entry, high construction					CAV 10 YX29	29	MAV 10 YX40	40

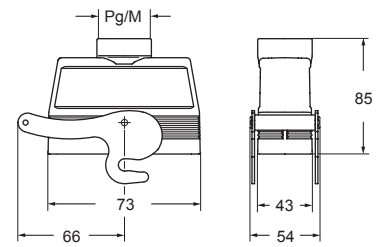
☑ Even when coding is not required, it is recommended to use CRM and CRF pins with CD and CDD inserts and CRM CX and CRF CX pins with MIXO inserts to reduce movements when fitting and removing the connectors and to avoid contact damages.

Within this scope, the EN 175301-801 standard (former DIN 43 652) requires a maximum angular fluctuation of $\pm 5^\circ$ on the long side, $\pm 2^\circ$ on the short side.

CAO..YX and MAO..YX



CAV..YX and MAV..YX



CAU[®]US Type 4/4X/12



CA - MA and CF - MF CENTRAL LEVER

inserts		page:
CDD	42 poles + ⊕	78
CDS	18 poles + ⊕	-
CDSH	18 poles + ⊕	87
CNE	10 poles + ⊕	111
CSE	10 poles + ⊕	-
CSH	10 poles + ⊕	111
CSH S	10 poles + ⊕	123
CCE	10 poles + ⊕	131
CMSH	3+2 (aux) poles + ⊕	136
CMCE	3+2 (aux) poles + ⊕	137
CSS	10 poles + ⊕	149
CQE	18 poles + ⊕	169
CX	8/24 poles + ⊕	194
MIXO	3 modules	262 - 317

hoods for central lever



hoods for central lever



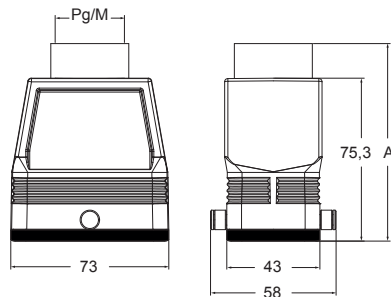
description	part No.	entry Pg	part No.	entry M	part No.	entry Pg	part No.	entry M
with pegs, top entry, high construction	CAV 10 GYC21	21	MAV 10 GYC25	25				
with pegs, top entry, high construction	CAV 10 GYC29	29	MAV 10 GYC32	32				
with pegs, top entry, high construction			MAV 10 GYC40	40				
with pegs, top entry, high construction, without adapter ¹⁾					CFV 10 GYC21	21	MFV 10 GYC25	25
with pegs, top entry, high construction, without adapter ¹⁾					CFV 10 GYC29	29	MFV 10 GYC32	32
with pegs, top entry, high construction, without adapter ¹⁾							MFV 10 GYC40	40

¹⁾ enclosure without adapter, threaded on the body, to be used only with a complete cable gland.

☑ Even when coding is not required, it is recommended to use CRM and CRF pins with CD and CDD inserts and CRM CX and CRF CX pins with MIXO inserts to reduce movements when fitting and removing the connectors and to avoid contact damages.

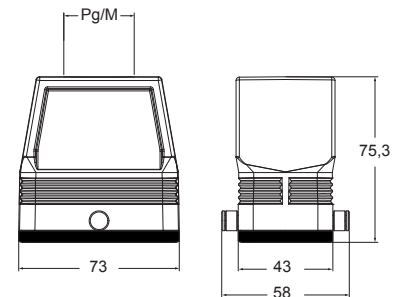
Within this scope, the EN 175301-801 standard (former DIN 43 652) requires a maximum angular fluctuation of ±5° on the long side, ±2° on the short side.

CAV..GYC and MAV GYC



part No.	A
CAV 10 GYC21	90,3
CAV 10 GYC29	91,8
MAV 10 GYC25	90,3
MAV 10 GYC32	91,3
MAV 10 GYC40	94,3

CFV..GYC and MFV..GYC



CAV[®]US Type 4/4X/12



CH - CA and MA CENTRAL LEVER

inserts		page:
CD	40 poles + ⊕	70
CDD	72 poles + ⊕	79
CDS	27 poles + ⊕	-
CDSH	27 poles + ⊕	88
CNE	16 poles + ⊕	112
CSE	16 poles + ⊕	-
CSH	16 poles + ⊕	112
CSH S	16 poles + ⊕	124
CCE	16 poles + ⊕	132
CMSH, CMCE	6+2 (aux) poles + ⊕	138 - 139
CSS	16 poles + ⊕	150
CT, CTS (10A *)	40 poles + ⊕	156
CT, CTSE (16A *)	16 poles + ⊕	162
CQE	32 poles + ⊕	170
CQEE	40 poles + ⊕	176
CP	6 poles + ⊕	178
CX	6/12, 6/36 and 12/2 poles + ⊕	197 - 199
CX	4/0 and 4/2 poles + ⊕	200 - 201
MIXO	4 modules	262 - 317

*) can be used only in bulkhead mounting housings

bulkhead mounting housings for central lever



surface mounting housings, with two entries for central lever



description	part No.	part No.	entry Pg	part No.	entry M
-------------	----------	----------	----------	----------	---------

bulkhead mounting with pegs **CHI 16 YC**

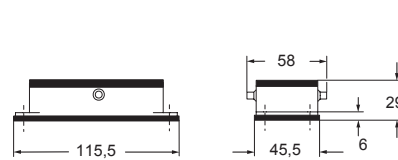
surface mounting, high construction, with pegs

CAP 16 YC229 29x2

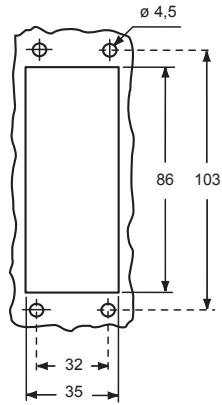
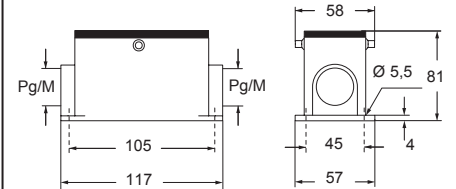
MAP 16 YC232 32x2

panel cut-out for bulkhead mounting housings

CHI YC



CAP YC and MAP YC



☑ Even when coding is not required, it is recommended to use CRM and CRF pins with CD and CDD inserts and CRM CX and CRF CX pins with MIXO inserts to reduce movements when fitting and removing the connectors and to avoid contact damages.

Within this scope, the EN 175301-801 standard (former DIN 43 652) requires a maximum angular fluctuation of $\pm 5^\circ$ on the long side, $\pm 2^\circ$ on the short side.

CAIUS Type 4/4X/12



CA and MA CENTRAL LEVER

inserts		page:
CD	40 poles + ⊕	70
CDD	72 poles + ⊕	79
CDS	27 poles + ⊕	-
CDSH	27 poles + ⊕	88
CNE	16 poles + ⊕	112
CSE	16 poles + ⊕	-
CSH	16 poles + ⊕	112
CSH S	16 poles + ⊕	124
CCE	16 poles + ⊕	132
CMSH, CMCE	6+2 (aux) poles + ⊕	138 - 139
CSS	16 poles + ⊕	150
CQE	32 poles + ⊕	170
CQEE	40 poles + ⊕	176
CP	6 poles + ⊕	178
CX	6/12, 6/36 and 12/2 poles + ⊕	197 - 199
CX	4/0 and 4/2 poles + ⊕	200 - 201
MIXO	4 modules	262 - 317

hoods with central lever



hoods with central lever

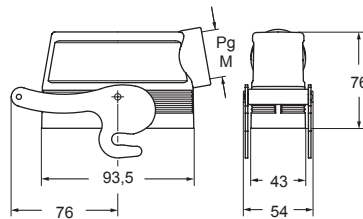


description	part No.		entry		part No.		entry	
			Pg	M			Pg	M
side entry, high construction	CAO 16 YX21	21	MAO 16 YX32	32				
side entry, high construction	CAO 16 YX29	29	MAO 16 YX40	40				
top entry, high construction	CAV 16 YX21	21	MAV 16 YX32	32				
top entry, high construction	CAV 16 YX29	29	MAV 16 YX40	40				

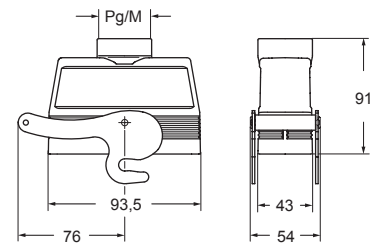
Even when coding is not required, it is recommended to use CRM and CRF pins with CD and CDD inserts and CRM CX and CRF CX pins with MIXO inserts to reduce movements when fitting and removing the connectors and to avoid contact damages.

Within this scope, the EN 175301-801 standard (former DIN 43 652) requires a maximum angular fluctuation of $\pm 5^\circ$ on the long side, $\pm 2^\circ$ on the short side.

CAO..YX and MAO..YX



CAV..YX and MAV..YX



CAUS® Type 4/4X/12



CA - MA and CF - MF CENTRAL LEVER

inserts		page:
CD	40 poles + ⊕	70
CDD	72 poles + ⊕	79
CDS	27 poles + ⊕	-
CDSH	27 poles + ⊕	88
CNE	16 poles + ⊕	112
CSE	16 poles + ⊕	-
CSH	16 poles + ⊕	112
CSH S	16 poles + ⊕	124
CCE	16 poles + ⊕	132
CMSH, CMCE	6+2 (aux) poles + ⊕	138 - 139
CSS	16 poles + ⊕	150
CQE	32 poles + ⊕	170
CQEE	40 poles + ⊕	176
CP	6 poles + ⊕	178
CX	6/12, 6/36 and 12/2 poles + ⊕	197 - 199
CX	4/0 and 4/2 poles + ⊕	200 - 201
MIXO	4 modules	262 - 317

hoods for central lever



hoods for central lever



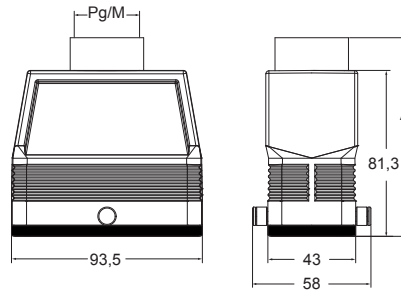
description	part No.	entry Pg	part No.	entry M	part No.	entry Pg	part No.	entry M
with pegs, top entry, high construction	CAV 16 GYC21	21	MAV 16 GYC25	25				
with pegs, top entry, high construction	CAV 16 GYC29	29	MAV 16 GYC32	32				
with pegs, top entry, high construction			MAV 16 GYC40	40				
with pegs, top entry, high construction, without adapter ¹⁾					CFV 16 GYC21	21	MFV 16 GYC25	25
with pegs, top entry, high construction, without adapter ¹⁾					CFV 16 GYC29	29	MFV 16 GYC32	32
with pegs, top entry, high construction, without adapter ¹⁾							MFV 16 GYC40	40

¹⁾ enclosure without adapter, threaded on the body, to be used only with a complete cable gland.

☑ Even when coding is not required, it is recommended to use CRM and CRF pins with CD and CDD inserts and CRM CX and CRF CX pins with MIXO inserts to reduce movements when fitting and removing the connectors and to avoid contact damages.

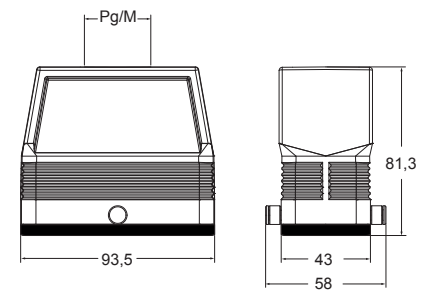
Within this scope, the EN 175301-801 standard (former DIN 43 652) requires a maximum angular fluctuation of ±5° on the long side, ±2° on the short side.

CAV..GYC and MAV..GYC



part No.	A
CAV 16 GYC21	96,3
CAV 16 GYC29	97,8
MAV 16 GYC25	96,3
MAV 16 GYC32	97,6
MAV 16 GYC40	100,3

CFV..GYC and MFV..GYC



CAIUS Type 4/4X/12



CH - CA and MA CENTRAL LEVER

inserts		page:
CD	64 poles + ⊕	72
CDD	108 poles + ⊕	81
CDS	42 poles + ⊕	-
CDSH	42 poles + ⊕	89
CNE	24 poles + ⊕	113
CSE	24 poles + ⊕	-
CSH	24 poles + ⊕	113
CSH S	24 poles + ⊕	125
CCE	24 poles + ⊕	133
CMSH	10+2 (aux) poles + ⊕	140
CMCE	10+2 (aux) poles + ⊕	141
CSS	24 poles + ⊕	151
CT, CTS (10A) *)	64 poles + ⊕	157
CT, CTSE (16A) *)	24 poles + ⊕	163
CQE	46 poles + ⊕	171
CQEE	64 poles + ⊕	177
CX	4/8 and 6/6 poles + ⊕	204, 206
MIXO	6 modules	262 - 317

*) can be used only in bulkhead mounting housings

bulkhead mounting housings for central lever

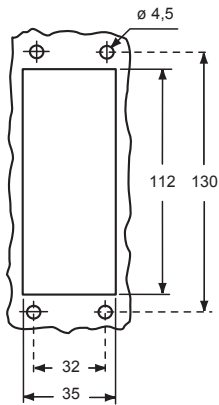


surface mounting housings, with two entries, for central lever



description	part No.	part No.	entry Pg	part No.	entry M
bulkhead mounting with pegs	CHI 24 YC				
surface mounting, high construction, with pegs		CAP 24 YC229	29x2	MAP 24 YC232	32x2

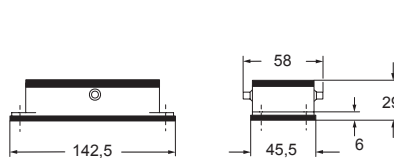
panel cut-out for bulkhead mounting housings



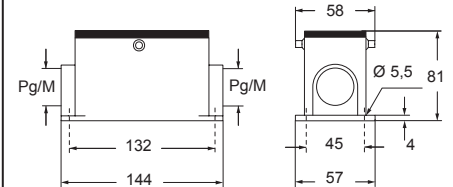
☑ Even when coding is not required, it is recommended to use CRM and CRF pins with CD and CDD inserts and CRM CX and CRF CX pins with MIXO inserts to reduce movements when fitting and removing the connectors and to avoid contact damages.

Within this scope, the EN 175301-801 standard (former DIN 43 652) requires a maximum angular fluctuation of $\pm 5^\circ$ on the long side, $\pm 2^\circ$ on the short side.

CHI YC



CAP YC and MAP YC



CAIUS® Type 4/4X/12



CA and MA - CI and MI CENTRAL LEVER

inserts		page:
CD	64 poles + ⊕	72
CDD	108 poles + ⊕	81
CDS	42 poles + ⊕	-
CDSH	42 poles + ⊕	89
CNE	24 poles + ⊕	113
CSE	24 poles + ⊕	-
CSH	24 poles + ⊕	113
CSH S	24 poles + ⊕	125
CCE	24 poles + ⊕	133
CMSH	10+2 (aux) poles + ⊕	140
CMCE	10+2 (aux) poles + ⊕	141
CSS	24 poles + ⊕	151
CQE	46 poles + ⊕	171
CQEE	64 poles + ⊕	177
CX	4/8 and 6/6 poles + ⊕	204, 206
MIXO	6 modules	262 - 317

hoods with central lever



inclined hoods with central lever

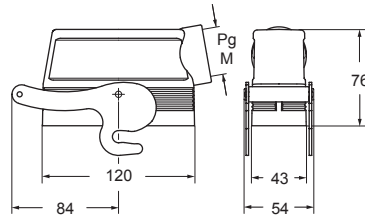


description	part No.		entry Pg		part No.		entry M	
side entry, high construction	CAO 24 YX21	21	MAO 24 YX32	32				
side entry, high construction	CAO 24 YX29	29	MAO 24 YX40	40				
top entry, high construction	CAV 24 YX21	21	MAV 24 YX32	32				
top entry, high construction	CAV 24 YX29	29	MAV 24 YX40	40				
side entry, high construction					CIO 24 YX36	36	MIO 24 YX40	40
side entry, high construction							MIO 24 YX50	50
top entry, high construction							MIV 24 YX40	40
top entry, high construction					CIV 24 YX36	36	MIV 24 YX50	50

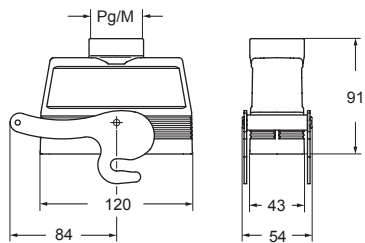
Even when coding is not required, it is recommended to use CRM and CRF pins with CD and CDD inserts and CRM CX and CRF CX pins with MIXO inserts to reduce movements when fitting and removing the connectors and to avoid contact damages.

Within this scope, the EN 175301-801 standard (former DIN 43 652) requires a maximum angular fluctuation of $\pm 5^\circ$ on the long side, $\pm 2^\circ$ on the short side.

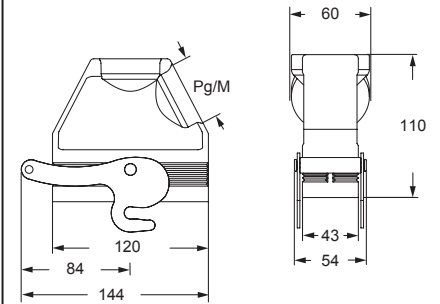
CAO..YX and MAO..YX



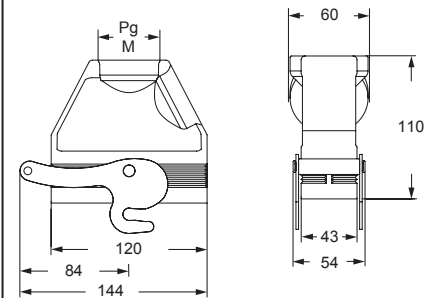
CAV..YX and MAV..YX



CIO..YX and MIO..YX



CIV..YX and MIV..YX



CRUS Type 4/4X/12



CA - MA and CF - MF CENTRAL LEVER

inserts		page:
CD	64 poles + ⊕	72
CDD	108 poles + ⊕	81
CDS	42 poles + ⊕	-
CDSH	42 poles + ⊕	89
CNE	24 poles + ⊕	113
CSE	24 poles + ⊕	-
CSH	24 poles + ⊕	113
CSH S	24 poles + ⊕	125
CCE	24 poles + ⊕	133
CMSH	10+2 (aux) poles + ⊕	140
CMCE	10+2 (aux) poles + ⊕	141
CSS	24 poles + ⊕	151
CQE	46 poles + ⊕	171
CQEE	64 poles + ⊕	177
CX	4/8 and 6/6 poles + ⊕	204, 206
MIXO	6 modules	262 - 317

hoods for central lever



hoods for central lever



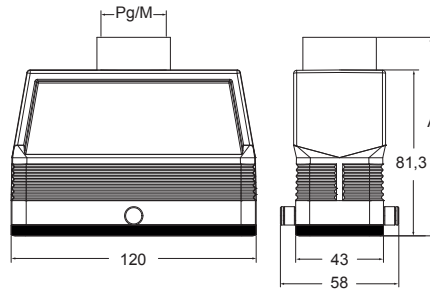
description	part No.	entry Pg	part No.	entry M	part No.	entry Pg	part No.	entry M
with pegs, top entry, high construction	CAV 24 GYC21	21	MAV 24 GYC25	25				
with pegs, top entry, high construction	CAV 24 GYC29	29	MAV 24 GYC32	32				
with pegs, top entry, high construction			MAV 24 GYC40	40				
with pegs, top entry, high construction, without adapter ¹⁾					CFV 24 GYC21	21	MFV 24 GYC25	25
with pegs, top entry, high construction, without adapter ¹⁾					CFV 24 GYC29	29	MFV 24 GYC32	32
with pegs, top entry, high construction, without adapter ¹⁾							MFV 24 GYC40	40

¹⁾ enclosure without adapter, threaded on the body, to be used only with a complete cable gland.

☑ Even when coding is not required, it is recommended to use CRM and CRF pins with CD and CDD inserts and CRM CX and CRF CX pins with MIXO inserts to reduce movements when fitting and removing the connectors and to avoid contact damages.

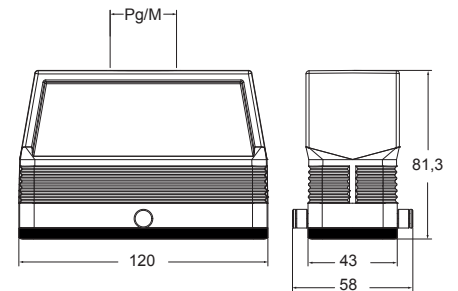
Within this scope, the EN 175301-801 standard (former DIN 43 652) requires a maximum angular fluctuation of ±5° on the long side, ±2° on the short side.

CAV..GYC and MAV..GYC



part No.	A
CAV 24 GYC21	96,3
CAV 24 GYC29	97,8
MAV 24 GYC25	96,3
MAV 24 GYC32	97,6
MAV 24 GYC40	100,3

CFV..GYC and MFV..GYC



Locking device for single stainless steel central locking lever

- **locking device**, made in **stainless steel**, with **proprietary design**, that can be easily placed on the side of the central lever of a "104.27" hood in order to lock the opening movement of the locking lever, thus avoiding any unwanted and potentially hazardous accidental opening of the connector coupling under working condition;
- **possibility to apply, optionally, a padlock** (CR BLC622, separately available, 6 mm shackle diameter, 22 mm arc clearance) with **anti-tamper function**, to secure the locking against any unauthorized attempt to open the locking lever and disconnect the connector coupling;
- **two versions available:**
with eyelet cord end, **CR YLK24** (see page 667) for the fastening to a housing of a central lever coupling when not in use;



with "loop" cord end, **CR YLK24 SL** (see page 667) for the fastening to a hood when not in use (around the incoming cable).



LS-TYPE



LS-TYPE series

On stage

The **LS-TYPE** enclosures are the ideal solution for the entertainment industry (lighting system power supply and related mixer and dimmer panels), including theatre stages, film sets, radio and TV studios, discos, trade fair booths, concert halls and night public events, both indoors and outdoors, etc.

All parts are in elegant RAL 9005 black to make them suitable for situations and locations where they should not be visible in the dark.

Functional characteristics

These enclosures can be installed beside stages. They do not have any bright components that would distract and simple plastic levers that are easy to replace.

- ✔ UL certified for USA and Canada for NEMA 4, NEMA 4X and NEMA 12 degrees of protection (enclosure type ratings) printed on the packaging.
IP65/IP69 degree of protection.



SUM-UP OF MATERIALS USED FOR CH..N - MA..N and MH..N - MF..N LS-TYPE series

- ☐ Made of die cast aluminium alloy
- ☐ Powder-coated with RAL 9005
- ☐ Gaskets in anti-aging, oil resistant, grease resistant and fuel resistant vinyl nitrile elastomer
- ☐ Locking device with levers in black made of plastic
- ☐ Ambient temperature range -40 °C / +125 °C.

CH..N - MA..N and MH..N - MF..N LS-TYPE version

inserts		page:
CDD	24 poles + ⊕	76
CDS	9 poles + ⊕	-
CDSH	9 poles + ⊕	86
CDSH NC	6 poles + ⊕	95
CNE	6 poles + ⊕	110
CSE	6 poles + ⊕	-
CSH	6 poles + ⊕	110
CSH S	6 poles + ⊕	122
CCE	6 poles + ⊕	130
CSS	6 poles + ⊕	148
CT, CTSE (16A) *	6 poles + ⊕	160
CQE	10 poles + ⊕	168
MIXO	2 modules	262 - 317

*) only in the CHIN 06 LCH and CHIN 06 L enclosure

housings with 2 pegs and 1 lever



hoods with 2 pegs

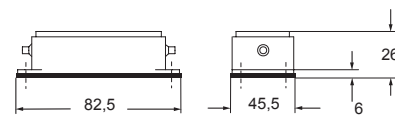


description	part No.	entry M	part No.	entry M
bulkhead mounting housing, with 2 pegs	CHIN 06 LCH			
bulkhead mounting housing, with lever	CHIN 06 L			
surface mounting housing, high construction, with lever	MAPN 06 L32	32		
with pegs, side entry			MHON 06 L25	25
with pegs, top entry			MHVN 06 L25	25
with pegs, side entry, high construction, without adapter ¹⁾			MFON 06 L25	25
with pegs, top entry, high construction, without adapter ¹⁾			MFVN 06 L25	25

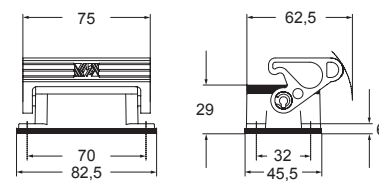
¹⁾ enclosure without adapter, threaded on the enclosure body, to be used only with a complete cable gland.

- kiln powder coating with RAL 9005 black epoxy polyester powder
- RAL 9005 black self-extinguishing thermoplastic locking lever

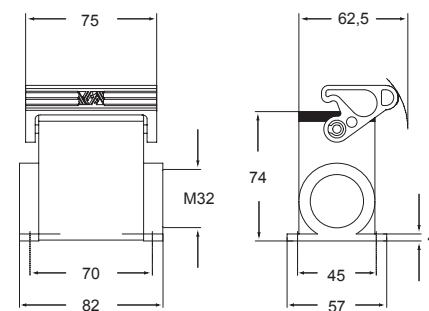
CHIN LCH



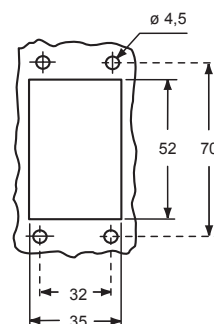
CHIN L



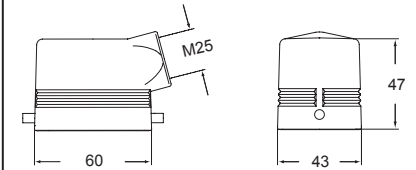
MAPN L32



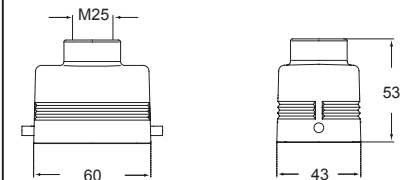
panel cut-out for bulkhead mounting housings CHIN LCH and CHIN L



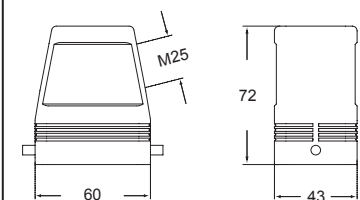
MHON L25



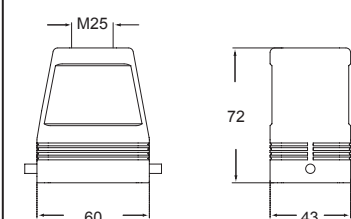
MHVN L25



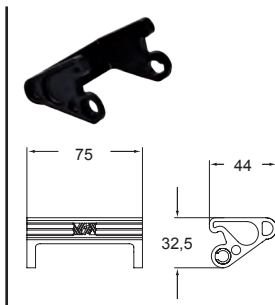
MFON L25



MFVN L25



CR LN
Spare part lever for "44.27" enclosures with levers



CAUS Type 4/4X/12



CH..N and MH..N - MF..N LS-TYPE version

inserts		page:
CDD	24 poles + ⊕	76
CDS	9 poles + ⊕	-
CDSH	9 poles + ⊕	86
CDSH NC	6 poles + ⊕	95
CNE	6 poles + ⊕	110
CSE	6 poles + ⊕	-
CSH	6 poles + ⊕	110
CSH S	6 poles + ⊕	122
CCE	6 poles + ⊕	130
CSS	6 poles + ⊕	148
CQE	10 poles + ⊕	168
MIXO	2 modules	262 - 317

hoods with single lever



covers



description	part No.	entry M	part No. (with eyelet)	part No. (with loop)
-------------	----------	---------	------------------------	----------------------

with lever and gasket, top entry
with lever and gasket, top entry, high construction, without adapter ¹⁾

MHVN 06 LG25 25
MFVN 06 LG25 25

covers with pegs
covers with lever

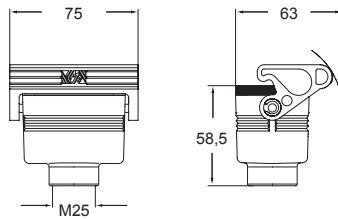
CHCN 06 L

CHCN 06 LG

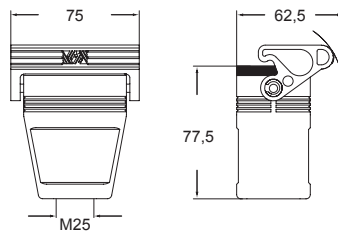
¹⁾ enclosure without adapter, threaded on the enclosure body, to be used only with a complete cable gland.

- kiln powder coating with RAL 9005 black epoxy polyester powder
- RAL 9005 black self-extinguishing thermoplastic locking lever

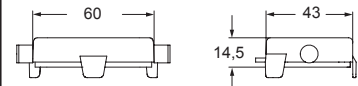
MHVN LG25



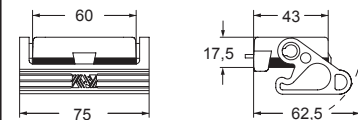
MFVN LG25



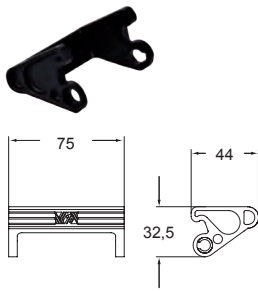
CHCN L



CHCN LG



CR LN
Spare part lever for "44.27" enclosures with levers

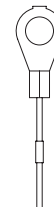


CRUS Type 4/4X/12



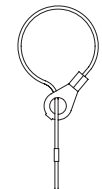
For fixing on housings

eyelet



For fixing on hoods

loop



CH..N - MA..N and MH..N - MF..N LS-TYPE version

inserts		page:
CDD	42 poles + ⊕	78
CDS	18 poles + ⊕	-
CDSH	18 poles + ⊕	87
CNE	10 poles + ⊕	111
CSE	10 poles + ⊕	-
CSH	10 poles + ⊕	111
CSH S	10 poles + ⊕	123
CCE	10 poles + ⊕	131
CMSH	3+2 (aux) poles + ⊕	136
CMCE	3+2 (aux) poles + ⊕	137
CSS	10 poles + ⊕	149
CT, CTSE (16A) *)	10 poles + ⊕	161
CQE	18 poles + ⊕	169
CX	8/24 poles + ⊕	194
MIXO	3 modules	262 - 317

*) only in the CHIN 10 CH and CHIN 10 enclosure

housings with 4 pegs and 2 levers



hoods with 4 pegs

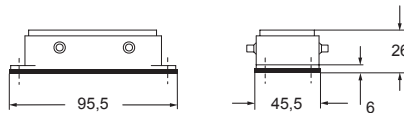


description	part No.		entry	
			M	
bulkhead mounting housing, with 4 pegs	CHIN 10 CH			
bulkhead mounting housing, with 2 levers	CHIN 10			
surface mounting housing, high construction, with 2 levers	MAPN 10.32		32	
with pegs, side entry	MHON 10.25			25
with pegs, top entry	MHVN 10.25			25
with pegs, side entry, high construction, without adapter ¹⁾	MFON 10.32			32
with pegs, top entry, high construction, without adapter ¹⁾	MFVN 10.32			32

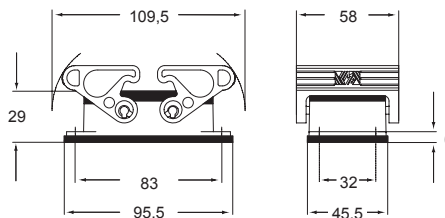
¹⁾ enclosure without adapter, threaded on the enclosure body, to be used only with a complete cable gland.

- kiln powder coating with RAL 9005 black epoxy polyester powder
- RAL 9005 black self-extinguishing thermoplastic locking lever

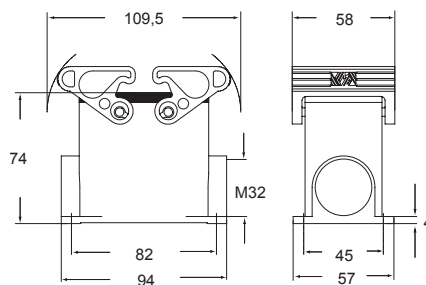
CHIN CH



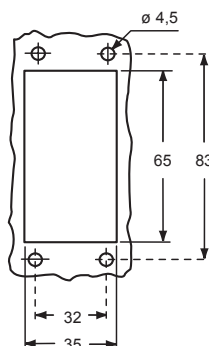
CHIN



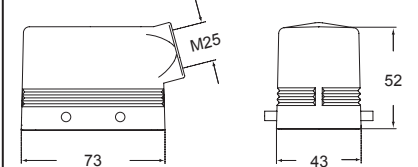
MAPN



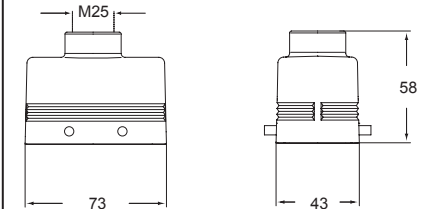
panel cut-out for bulkhead mounting housings CHIN CH and CHIN



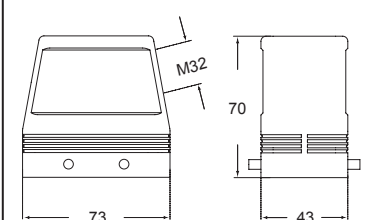
MHON



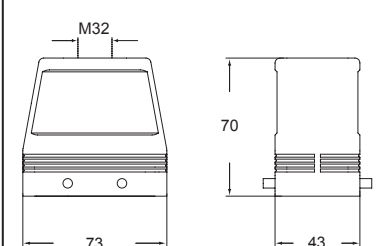
MHVN



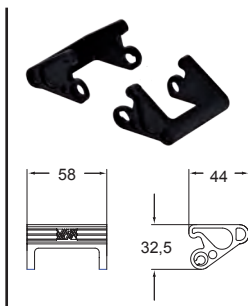
MFON



MFVN



CR LN
Spare part lever
for "57.27"
enclosures
with levers



CAIUS Type 4/4X/12



CH..N and MH..N - MF..N LS-TYPE version

inserts		page:
CDD	42 poles + ⊕	78
CDS	18 poles + ⊕	-
CDSH	18 poles + ⊕	87
CNE	10 poles + ⊕	111
CSE	10 poles + ⊕	-
CSH	10 poles + ⊕	111
CSH S	10 poles + ⊕	123
CCE	10 poles + ⊕	131
CMSH	3+2 (aux) poles + ⊕	136
CMCE	3+2 (aux) poles + ⊕	137
CSS	10 poles + ⊕	149
CQE	18 poles + ⊕	169
CX	8/24 poles + ⊕	194
MIXO	3 modules	262 - 317

hoods with 2 levers



covers



description	part No.	entry M	part No. (with eyelet)	part No. (with loop)
-------------	----------	---------	------------------------	----------------------

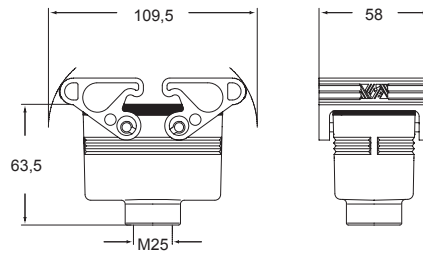
with levers and gasket, top entry	MHVN 10 G25	25		
with levers and gasket, top entry, high construction, without adapter ¹⁾	MFVN 10 G220	20 x 2		
with levers and gasket, top entry, high construction, without adapter ¹⁾	MFVN 10 G32	32		

covers with pegs	CHCN 10			
covers with 2 levers				CHCN 10 G

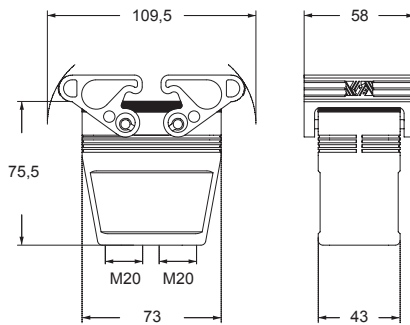
¹⁾ enclosure without adapter, threaded on the enclosure body, to be used only with a complete cable gland.

- kiln powder coating with RAL 9005 black epoxy polyester powder
- RAL 9005 black self-extinguishing thermoplastic locking lever

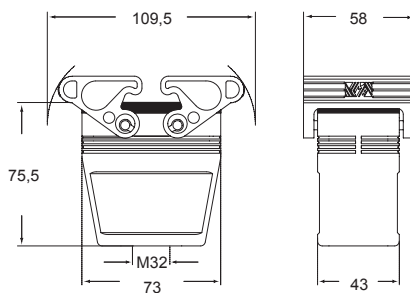
MHVN G25



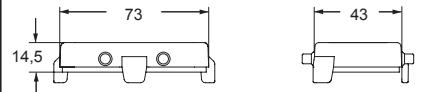
MFVN 10 G220



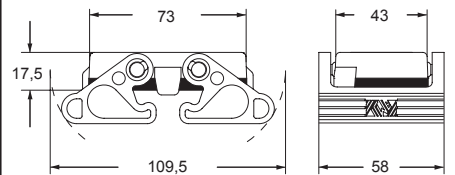
MFVN G32



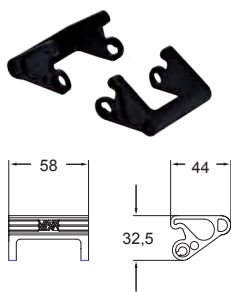
CHCN



CHCN G



CR LN
Spare part lever for "57.27" enclosures with levers

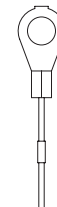


CRUS Type 4/4X/12



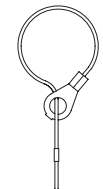
For fixing on housings

eyelet



For fixing on hoods

loop



CH..N - MA..N and MH..N - MF..N LS-TYPE version

inserts		page:
CD	40 poles + ⊕	70
CDD	72 poles + ⊕	79
CDS	27 poles + ⊕	-
CDSH	27 poles + ⊕	88
CNE	16 poles + ⊕	112
CSE	16 poles + ⊕	-
CSH	16 poles + ⊕	112
CSH S	16 poles + ⊕	124
CCE	16 poles + ⊕	132
CMSH, CMCE	6+2 (aux) poles + ⊕	138 - 139
CSS	16 poles + ⊕	150
CT, CTS (10A) *)	40 poles + ⊕	156
CT, CTSE (16A) *)	16 poles + ⊕	162
CQE	32 poles + ⊕	170
CQEE	40 poles + ⊕	176
CP	6 poles + ⊕	178
CX	6/12, 6/36 and 12/2 poles + ⊕	197 - 199
CX	4/0 and 4/2 poles + ⊕	200 - 201
MIXO	4 modules	262 - 317

*) only in the CHIN 16 CH and CHIN 16 enclosure

housings with 4 pegs and 2 levers



hoods with 4 pegs

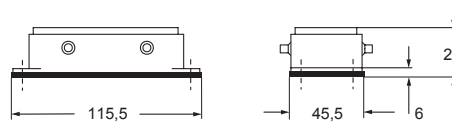


description	part No.	entry M	part No.	entry M
bulkhead mounting housing, with 4 pegs	CHIN 16 CH			
bulkhead mounting housing, with 2 levers	CHIN 16			
surface mounting housing, high construction, with 2 levers	MAPN 16.32	32		
with pegs, side entry			MHON 16.32	32
with pegs, top entry			MHVN 16.32	32
with pegs, side entry, high construction, without adapter ¹⁾			MFON 16.32	32
with pegs, top entry, high construction, without adapter ¹⁾			MFVN 16.32	32

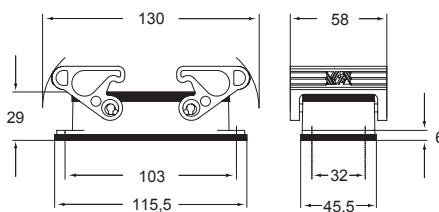
¹⁾ enclosure without adapter, threaded on the enclosure body, to be used only with a complete cable gland.

- kiln powder coating with RAL 9005 black epoxy polyester powder
- RAL 9005 black self-extinguishing thermoplastic locking lever

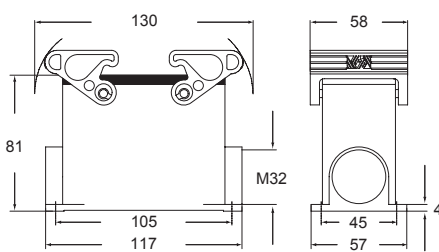
CHIN CH



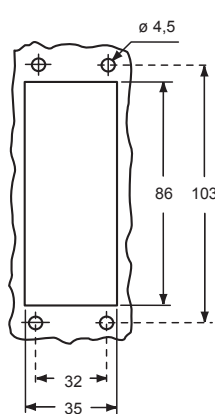
CHIN



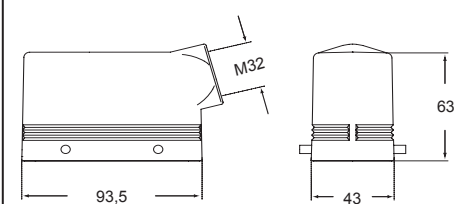
MAPN



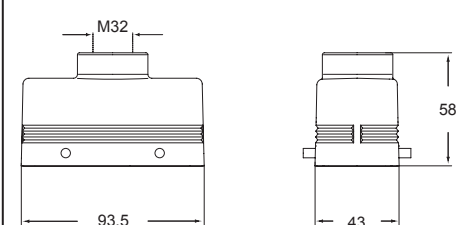
panel cut-out for bulkhead mounting housings CHIN CH and CHIN



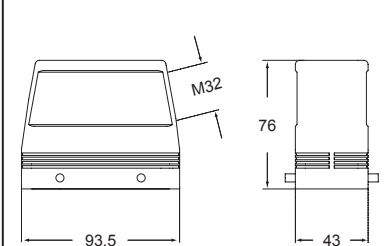
MHON



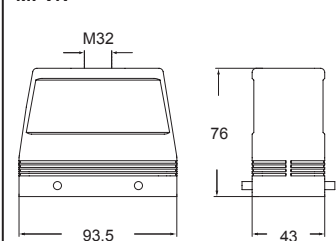
MHVN



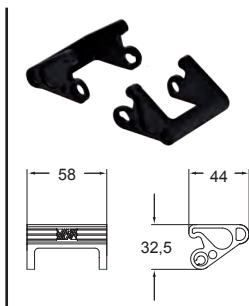
MFON



MFVN



CR LN
Spare part lever for "77.27" enclosures with levers



CAIUS Type 4/4X/12



CH..N and MH..N - MF..N LS-TYPE version

inserts		page:
CD	40 poles + ⊕	70
CDD	72 poles + ⊕	79
CDS	27 poles + ⊕	-
CDSH	27 poles + ⊕	88
CNE	16 poles + ⊕	112
CSE	16 poles + ⊕	-
CSH	16 poles + ⊕	112
CSH S	16 poles + ⊕	124
CCE	16 poles + ⊕	132
CMSH, CMCE	6+2 (aux) poles + ⊕	138 - 139
CSS	16 poles + ⊕	150
CQE	32 poles + ⊕	170
CQEE	40 poles + ⊕	176
CP	6 poles + ⊕	178
CX	6/12, 6/36 and 12/2 poles + ⊕	197 - 199
CX	4/0 and 4/2 poles + ⊕	200 - 201
MIXO	4 modules	262 - 317

hoods with 2 levers



covers



description	part No.	entry M	part No. (with eyelet)	part No. (with loop)
-------------	----------	---------	------------------------	----------------------

with levers and gasket, top entry	MHVN 16 G32	32		
with levers and gasket, top entry, high construction, without adapter ¹⁾	MFVN 16 G225	25 x 2		
with levers and gasket, top entry, high construction, without adapter ¹⁾	MFVN 16 G32	32		

covers with pegs
covers with 2 levers

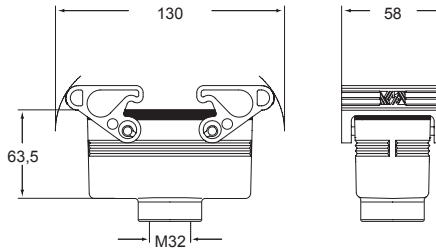
CHCN 16

CHCN 16 G

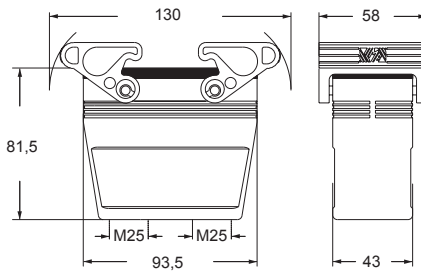
¹⁾ enclosure without adapter, threaded on the enclosure body, to be used only with a complete cable gland.

- kiln powder coating with RAL 9005 black epoxy polyester powder
- RAL 9005 black self-extinguishing thermoplastic locking lever

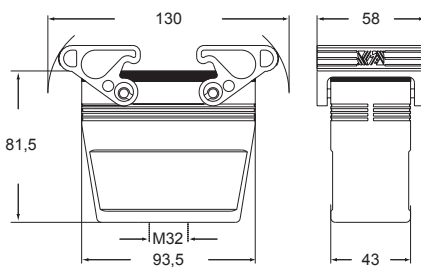
MHVN G32



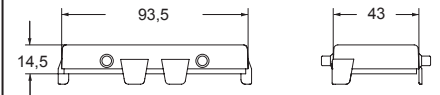
MFVN 16 G225



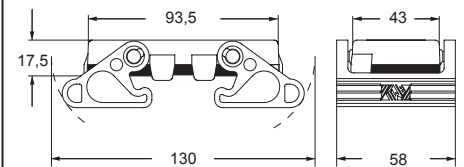
MFVN G32



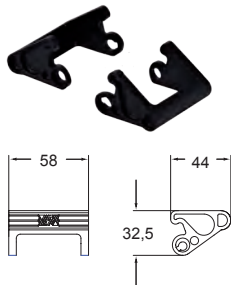
CHCN



CHCN G



CR LN
Spare part lever for "77.27" enclosures with levers

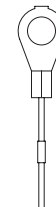


CAIUS Type 4/4X/12



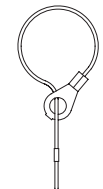
For fixing on housings

eyelet



For fixing on hoods

loop



CH..N - MA..N and MH..N - MF..N LS-TYPE version

inserts		page:
CD	64 poles + ⊕	72
CDD	108 poles + ⊕	81
CDS	42 poles + ⊕	-
CDSH	42 poles + ⊕	89
CNE	24 poles + ⊕	113
CSE	24 poles + ⊕	-
CSH	24 poles + ⊕	113
CSH S	24 poles + ⊕	125
CCE	24 poles + ⊕	133
CMSH	10+2 (aux) poles + ⊕	140
CMCE	10+2 (aux) poles + ⊕	141
CSS	24 poles + ⊕	151
CT, CTS (10A) *)	64 poles + ⊕	157
CT, CTSE (16A) *)	24 poles + ⊕	163
CQE	46 poles + ⊕	171
CQEE	64 poles + ⊕	177
CX	4/8 and 6/6 poles + ⊕	204 and 206
MIXO	6 modules	262 - 317

*) only in the CHIN 24 CH and CHIN 24 enclosure

housings with 4 pegs and 2 levers



hoods with 4 pegs

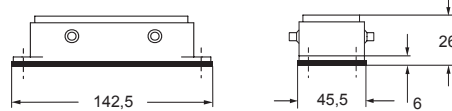


description	part No.	entry M	part No.	entry M
bulkhead mounting housing, with 4 pegs	CHIN 24 CH			
bulkhead mounting housing, with 2 levers	CHIN 24			
surface mounting housing, high construction, with 2 levers	MAPN 24.32	32		
with pegs, side entry			MHON 24.32	32
with pegs, top entry			MHVN 24.32	32
with pegs, side entry, high construction, without adapter ¹⁾			MFON 24.32	32
with pegs, top entry, high construction, without adapter ¹⁾			MFVN 24.32	32

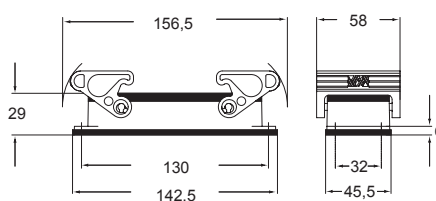
¹⁾ enclosure without adapter, threaded on the enclosure body, to be used only with a complete cable gland.

- kiln powder coating with RAL 9005 black epoxy polyester powder
- RAL 9005 black self-extinguishing thermoplastic locking lever

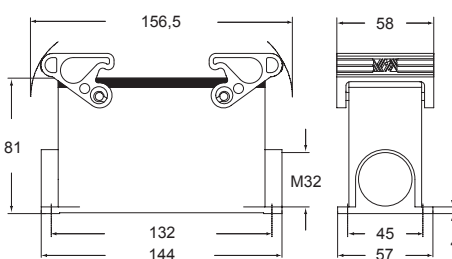
CHIN CH



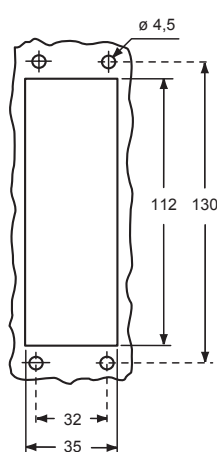
CHIN



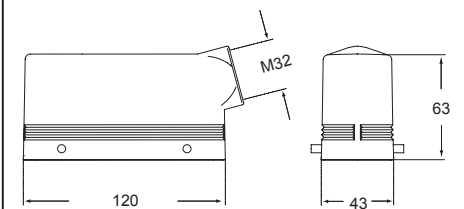
MAPN



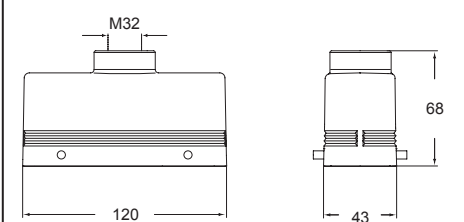
panel cut-out for bulkhead mounting housings
CHIN CH and CHIN



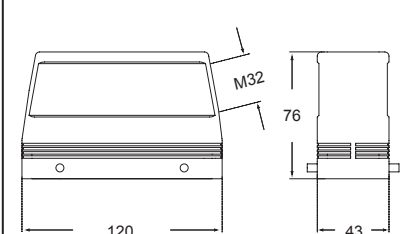
MHON



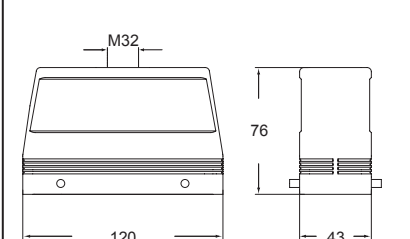
MHVN



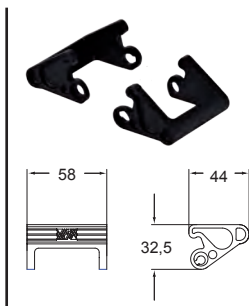
MFON



MFVN



CR LN
Spare part
lever
for "104.27"
enclosures
with levers



CAIUS Type 4/4X/12



CH..N and MH..N - MF..N LS-TYPE version

inserts		page:
CD	64 poles + ⊕	72
CDD	108 poles + ⊕	81
CDS	42 poles + ⊕	-
CDSH	42 poles + ⊕	89
CNE	24 poles + ⊕	113
CSE	24 poles + ⊕	-
CSH	24 poles + ⊕	113
CSH S	24 poles + ⊕	125
CCE	24 poles + ⊕	133
CMSH	10+2 (aux) poles + ⊕	140
CMCE	10+2 (aux) poles + ⊕	141
CSS	24 poles + ⊕	151
CQE	46 poles + ⊕	171
CQEE	64 poles + ⊕	177
CX	4/8 and 6/6 poles + ⊕	204 and 206
MIXO	6 modules	262 - 317

hoods with 2 levers



covers



description	part No.	entry M	part No. (with eyelet)	part No. (with loop)
-------------	----------	---------	------------------------	----------------------

with levers and gasket, top entry	MHVN 24 G32	32		
with levers and gasket, top entry, high construction, without adapter ¹⁾	MFVN 24 G232	32 x 2		
with levers and gasket, top entry, high construction, without adapter ¹⁾	MFVN 24 G32	32		

covers with pegs
covers with 2 levers

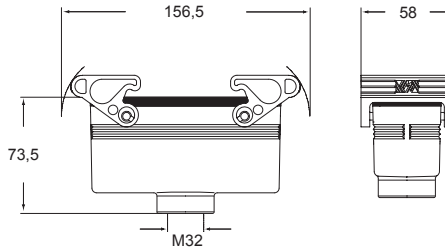
CHCN 24

CHCN 24 G

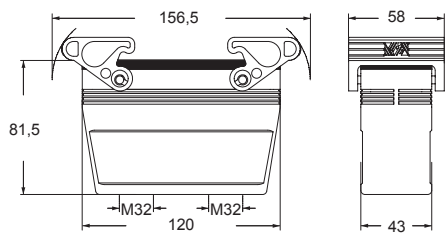
¹⁾ enclosure without adapter, threaded on the enclosure body, to be used only with a complete cable gland.

- kiln powder coating with RAL 9005 black epoxy polyester powder
- RAL 9005 black self-extinguishing thermoplastic locking lever

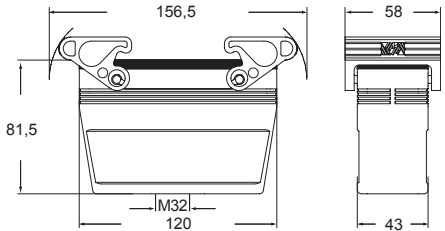
MHVN G32



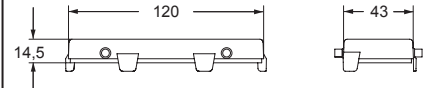
MFVN 24 G232



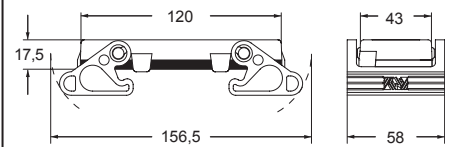
MFVN G32



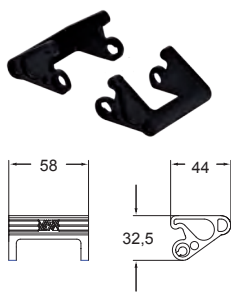
CHCN



CHCN G



CR LN
Spare part lever for "104.27" enclosures with levers

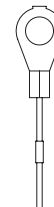


CAUS Type 4/4X/12



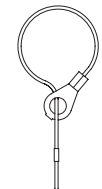
For fixing on housings

eyelet



For fixing on hoods

loop



CGK/MGK (“21.21”) series and CG/MG (“44.27”, “57.27”, “77.27”, “104.27”) series

CGK/MGK and CG/MG series of free and fixed enclosures (hoods and housings) for heavy-duty rectangular connectors combine water tightness to **IP68** according EN IEC 60529, the “versatile” complete IP degree of protection of these enclosures being currently IP66/IP68/IP69, high mechanical sturdiness and enhanced immunity to electromagnetic disturbances and shielding of the surrounding against emission (EMC features).

The enclosures ensure the highest degree of protection from external interferences; more specifically, they protect people from accessing the hazardous components housed inside the enclosures (protection against shock by direct contact) and they protect the internal connector inserts from the ingress of foreign matters (dust tightness) and from the harmful effects of ingress of fluids (water tightness).

The water tightness between the bulkhead-mounting housings and the panel is ensured by an O-ring seal held in position in a slot within the bulkhead-mounting housing base.

A second O-ring seal fitted around the mating edges of the enclosure ensures the water tightness between the free and the fixed enclosure when the connector is mated and locked.

To ensure the water tightness when the enclosure is fitted onto a cabinet panel, the optional mounting frame with four M6 threaded blind holes may need to be installed inside the panel.

The fastening screws must be fitted inside the enclosure and, through the fastening holes to be drilled on the panel, must be tightened onto the M6 mounting frame internal thread instead of the usual fastening nuts. The bulkhead-mounting fixed enclosure fastening holes have been drilled within the perimeter of the O-ring seal, in order to avoid having to use further seals.

Although these enclosures are larger than the standard enclosures, to leave more space for the cables, and the walls are thicker to achieve more mechanical robustness, the fixing points have remained the same as those of the standard enclosures. The series is offered with two types of locking systems: **bayonet** and **screw**.

The two closing points are located in asymmetrical positions on the short side of the housing so as to ensure an optimal water tightness while keeping the lowest footprint to allow more compactness in case of multiple enclosures placed one close to the other on the short side. The locking means of both versions are made of high quality stainless steel and are firmly fastened inside the free enclosure. These locking means can be fitted and removed by using either a 1,5 mm flat blade screwdriver or a 10 mm hexagonal key. The fixed and free enclosures of series CG/MG are made of foundry grade aluminium alloy, particularly resistant to seawater corrosion.

Series CGK/MGK enclosures are made of zinc alloy. The finish of CG/MG series is made from epoxy powder, which gives the enclosures high scratch and shock resistant properties as well as good chemical resistance.

The finish of CGK/MGK series (size “21.21”) is made by black chrome plating RoHS 2 conform.

The metal covers are made with the same quality materials as the enclosures, and are fitted with a short cord to make it always retrievable.

Scope of application

External interconnections in vehicles, in harsh environments and in humid areas and with sensitive interconnections requiring shielding from electromagnetic interference.

They are particularly suitable for the applications in the railway industry and any application requiring high resistance to pressure, impact and corrosion, with IP66/**IP68**/IP69 protection rating.

They also ensure a good shielding for electromagnetic compatibility.

The IP68 degree of protection marked or assigned to the enclosure is ensured if the enclosures are correctly installed and the cable entry devices have equal or higher IP rating.

Degree of protection compliant with EN IEC 60529

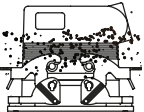
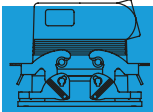
When mated and locked, the CGK/MGK (“21.21”) and the CG/MG enclosures protect the connector inserts fitted inside from outside interference, such as mechanical shocks, foreign bodies, humidity, dust, water or other fluids such as cleaning or cooling agents, oils, etc.

The IP68 degree of protection ensured by the enclosures is fully described in the EN IEC 60529 standard, which classifies the enclosures according to their protection against the entry of foreign bodies and water.

IP68 = Total protection against dust, and against the access to hazardous parts with access probe of Ø 1,0 mm (1st characteristic numeral), and protection against the effects of continuous submersion in water (duration ≥ 30 min upon agreement and water depth ≥ 1 m upon agreement) (2nd characteristic numeral).

These enclosures have also successfully passed the tests required for the **IPX6** degree of protection (tightness to powerful water jets) and for the **IPX9** degree of protection (high pressure and temperature water jets) according to EN IEC 60529. Their full “versatile” degree of protection is therefore **IP66/IP68/IP69**.

The following table shows only the IP 68 level of protection. Please see page 46 for the complete table of the different levels of protection specified by the IP standard.

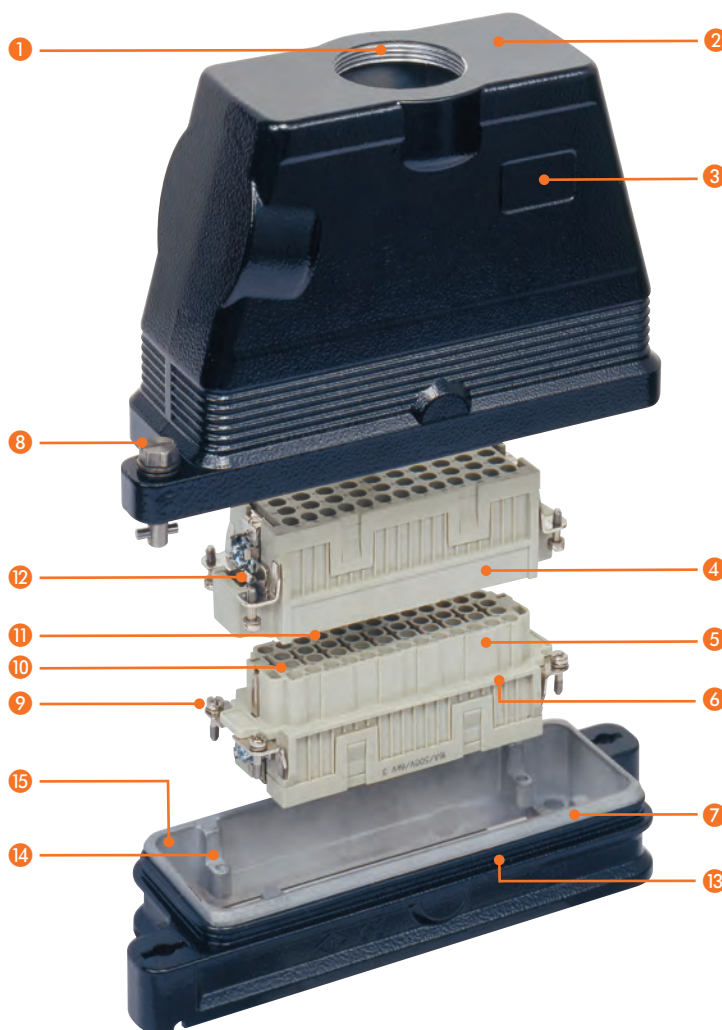
FIRST Index figure	Degree of protection SOLIDS	SECOND Index figure	Degree of protection WATER
6	 Protected against access to hazardous parts with a wire dust-tight (total protection against dust)	8	 Protected against the effects of continuous immersion in water at depth and/or duration upon agreement.

CG/MG (“44.27”, “57.27”, “77.27”, “104.27”) series

- 1 Threaded cable entry hole, available in different Pg diameters (types with prefix starting with “C”) or metric thread (types with prefix starting with “M”) compliant with EN 60423 standard, for cable entry devices compliant with EN IEC 62444 standard (former EN 50262), for vertical or horizontal layout.
- 2 Sturdy, corrosion proof foundry grade aluminium alloy enclosures, with RoHS 2 conform chromate treatment. The following types are available: wall mounted, flush mounted fixed and free enclosures with free protective cover.
- 3 Oven cured thermosetting paint with epoxy powder, colour black RAL 9005, which gives the enclosures a high mechanical strength and makes them resistant to external agents (only CG/MG).
- 4 The inserts are made of UL certified self-extinguishing fibreglass reinforced thermoplastics, and feature an operating temperature range between -40 °C and +125 °C.
- 5 Insert profile polarised with asymmetrical guides to avoid incorrect matings. The inserts have a mechanical life equal to or higher than 500 mating cycles.
- 6 Inserts are manufactured in compliance with European standard EN IEC 61984 (former DIN VDE 0627), certified and identified with UL and CSA marks, as well as EAC (Eurasian Customs Union) and CQC (China) marks, according to type and series.
- 7 Special NBR elastomer, anti-ageing, oil and fuel resistant seals which, together with the cable entry devices (not supplied) ensure mated connectors IP66/IP68/IP69 degree of protection. The seals are internally positioned to give a better protection from sunlight and outside elements.
- 8 Locking is available in two solutions: **screw-type** with hexagonal head stainless steel screws or **bayonet-type**. The slotted hexagonal head screws can be fitted and removed by using either a 1,6 mm thick blade screwdriver or a 10 mm hexagonal key, and can be easily accessed even when fitted on enclosures with horizontally exited cables. Tightening torque 2,5 Nm.



- 9 Captive insert fastening screws, with anti-slackening spring washer.
- 10 Contact position identified with numbers or codes on both sides of each insert and printed with a laser system or from a die.



- 11 Silver or gold plated brass contacts connected to the wires by means of captive screws supplied already slackened, with spring terminal (SQUICH®), by means of crimping (crimp contacts available separately), or with a built-in 45° terminal block (still with screw or spring terminal).
- 12 Pre-leading (FMLB) protective earth terminal with a wide contact surface.
- 13 Fixed, bulkhead-mount enclosure with fastening screws inside the gasket.
- 14 Wider enclosures to give more space for the cabling.
- 15 They ensure a good screening for electromagnetic compatibility, resistance to vibrations in compliance with EN 61373 railway standard and to pressurised water (IPX9).

CGK and MGK high protection IP68 version

inserts		page:
CK	3 and 4 poles + ⊕	58
CKS	3 and 4 poles + ⊕	-
CKSH	3 and 4 poles + ⊕	63
CD *	8 poles	67
CQ4	2 poles + ⊕	182
CQ4 H	2 poles + ⊕	183
CQ4	3 poles + ⊕	184
CQ	5 poles + ⊕	186
CQ	7 poles + ⊕	187
CQ	12 poles + ⊕	189
CQ	21 poles	190
CJ KF (can be used only in I enclosures)		223
CJK 8FT		226
CJK 8IFT		226, 228
CUK 2FT		236
CUK 3FT		236
CLK 04 SC		239
CX 1/2 BD		243

* To ensure IP68 degree of protection with CD 08 insert, purchase the kit CKR 65 D.

☑ In this case do not use the screw supplied with the enclosure.

bulkhead mounting housings



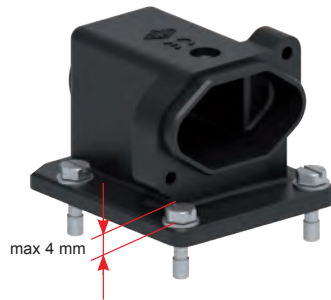
angled bulkhead mounting housings



description	part No.	part No.	entry Pg	part No.	entry M
bulkhead mounting housing	CGK I	CGK IA			
without cable entry (on request) ¹⁾		CGK IAP13	13,5	MGK IAP20	20
with cable entry, bottom closed ¹⁾					

¹⁾ Not suitable for CQ4 series inserts

ANGLED BULKHEAD MOUNTING HOUSINGS



- Eliminate the gasket and the fixing screw; provided with the insert.
- To fix the insert, use the screw with gasket provided with the enclosure (except CD 08 see note above).



CGKCP FX
dust protection cover
(page 697)

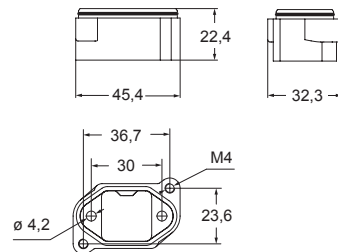


CAIUS® Type 4/4X/12

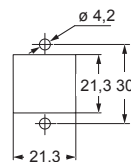


according to IEC/EN 60529

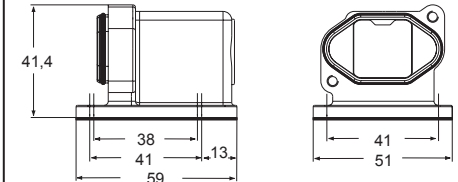
CGK I



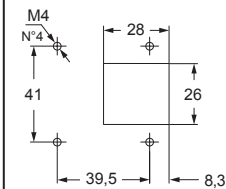
panel cut-out for CGK I enclosures



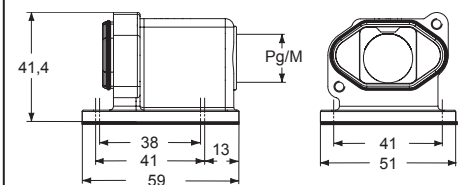
CGK IA



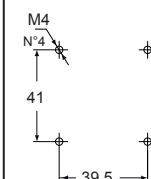
panel cut-out for CGK IA enclosures



CGK IAP and MGK IAP



panel cut-out for CGK/MGK IAP enclosures



CGK and MGK high protection IP68 version (screw locking)

inserts		page:
CK	3 and 4 poles + ⊕	58
CKS	3 and 4 poles + ⊕	-
CKSH	3 and 4 poles + ⊕	63
CD *	8 poles	67
CQ4	2 poles + ⊕	182
CQ4 H	2 poles + ⊕	183
CQ4	3 poles + ⊕	184
CQ	5 poles + ⊕	186
CQ	7 poles + ⊕	187
CQ	12 poles + ⊕	189
CQ	21 poles	190
CJ KM (can be used only in hoods)		223
CJK 8MT		226
CJK 8IMT	226, 228	228
CUK 2FT		236
CUK 3FT		236
CLK 04 SC		239
CX 1/2 BD		243

* To ensure IP68 degree of protection with CD 08 insert, purchase the kit CKR 65 D.

In this case do not use the screw supplied with the enclosure.

hoods



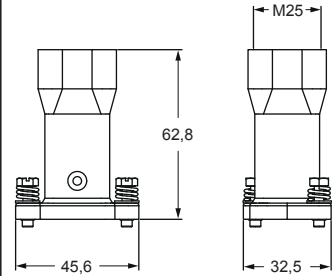
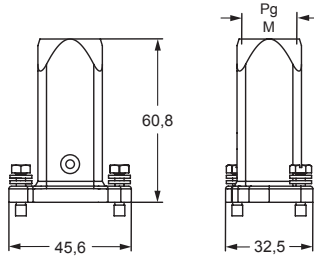
hoods



description	part No.	entry Pg	part No.	entry M	part No.	entry M
top entry ¹⁾	CGK V13	13,5	MGK V20	20		
top entry					MGK V25	25

¹⁾ Not suitable for CQ4 series inserts

- Eliminate the gasket and the fixing screw; provided with the insert
- To fix the insert, use the screw with gasket provided with the enclosure (except CD 08 see note above).



CGKCP MB
dust protection cover
(page 697)



CAIUS Type 4/4X/12



according to IEC/EN 60529

CAIUS Type 12

Type 4/4X only with CKR 65 (D) pending



according to IEC/EN 60529

CGK high protection IP68 version (bayonet locking)

inserts		page:
CK	3 and 4 poles + ⊕	58
CKS	3 and 4 poles + ⊕	-
CKSH	3 and 4 poles + ⊕	63
CD *	8 poles	67
CQ4	2 poles + ⊕	182
CQ4 H	2 poles + ⊕	183
CQ4	3 poles + ⊕	184
CQ	5 poles + ⊕	186
CQ	7 poles + ⊕	187
CQ	12 poles + ⊕	189
CQ	21 poles	190
CJ KF (can be used only in I enclosures)		223
CJK 8FT		226
CJK 8IFT		226, 228
CUK 2FT		236
CUK 3FT		236
CLK 04 SC		239
CX 1/2 BD		243

* To ensure IP68 degree of protection with CD 08 insert, purchase the kit CKR 65 D.

In this case do not use the screw supplied with the enclosure.

bulkhead mounting housings

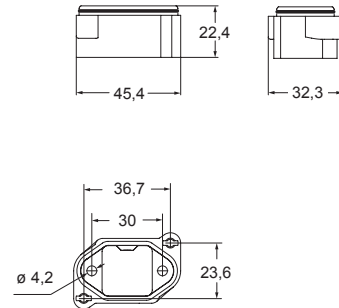


description	part No.
-------------	----------

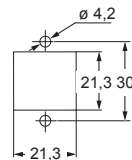
bulkhead mounting housing

CGK I B

- Eliminate the gasket and the fixing screw; provided with the insert
- To fix the insert, use the screw with gasket provided with the enclosure (except CD 08 see note above).



panel cut-out for CGK I B enclosures



CGKCP FX
dust protection cover
(page 697)



CAVUS® Type 4/4X/12



according to IEC/EN 60529

IP68

CGK and MGK high protection IP68 version (bayonet locking)

inserts		page:
CK	3 and 4 poles + ⊕	58
CKS	3 and 4 poles + ⊕	-
CKSH	3 and 4 poles + ⊕	63
CD *	8 poles	67
CQ4	2 poles + ⊕	182
CQ4 H	2 poles + ⊕	183
CQ4	3 poles + ⊕	184
CQ	5 poles + ⊕	186
CQ	7 poles + ⊕	187
CQ	12 poles + ⊕	189
CQ	21 poles	190
CJ KM (can be used only in hoods)		223
CJK 8MT		226
CJK 8IMT	226, 228	
CUK 2FT		236
CUK 3FT		236
CLK 04 SC		239
CX 1/2 BD		243

* To ensure IP68 degree of protection with CD 08 insert, purchase the kit CKR 65 D.

In this case do not use the screw supplied with the enclosure.

hoods



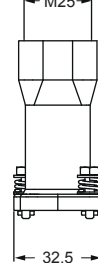
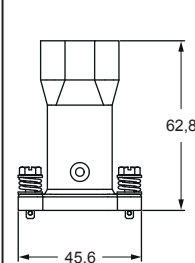
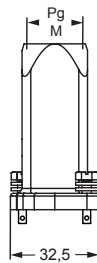
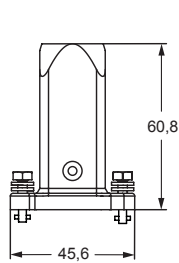
hoods



description	part No.	entry Pg	part No.	entry M	part No.	entry M
top entry ¹⁾	CGK V13 B	13,5	MGK V20 B	20		
top entry					MGK V25 B	25

¹⁾ Not suitable for CQ4 series inserts

- Eliminate the gasket and the fixing screw; provided with the insert
- To fix the insert, use the screw with gasket provided with the enclosure (except CD 08 see note above).



CGKCP MB
dust protection cover
(page 697)



CRUS Type 4/4X/12



according to IEC/EN 60529

CRUS Type 12

Type 4/4X only with CKR 65 (D) pending



according to IEC/EN 60529

CG and MG high protection IP68 version (screw locking)

inserts		page:
CDD	24 poles + ⊕	76
CDS	9 poles + ⊕	-
CDSH	9 poles + ⊕	86
CDSH NC	6 poles + ⊕	95
CNE	6 poles + ⊕	110
CSE	6 poles + ⊕	-
CSH	6 poles + ⊕	110
CSH S	6 poles + ⊕	122
CCE	6 poles + ⊕	130
CSS	6 poles + ⊕	148
CQE	10 poles + ⊕	168
MIXO	2 modules	262 - 317

bulkhead mounting housings

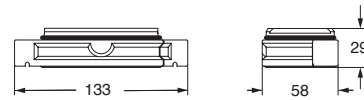


surface mounting housings

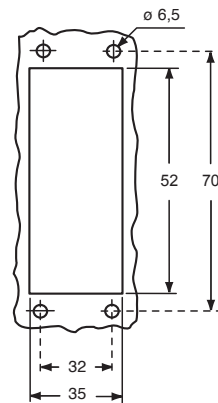


description	part No.	part No.	entry Pg	part No.	entry M
with gasket, size "44.27"	CGI 06	CGP 06.29	29	MGP 06.32	32
size "44.27"					

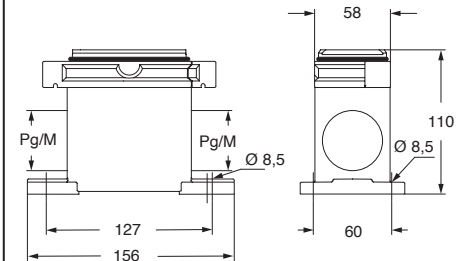
CGI



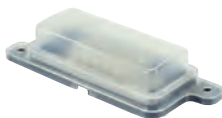
panel cut-out for bulkhead mounting housings



CGP and MGP



CGCP FX
Dust protection cover
(from page 697)



CAUS® Type 4/4X/12



according to IEC/EN 60529

CG and MG high protection IP68 version (screw locking)

inserts		page:
CDD	24 poles + ⊕	76
CDS	9 poles + ⊕	-
CDSH	9 poles + ⊕	86
CDSH NC	6 poles + ⊕	95
CNE	6 poles + ⊕	110
CSE	6 poles + ⊕	-
CSH	6 poles + ⊕	110
CSH S	6 poles + ⊕	122
CCE	6 poles + ⊕	130
CSS	6 poles + ⊕	148
CQE	10 poles + ⊕	168
MIXO	2 modules	262 - 317

hoods

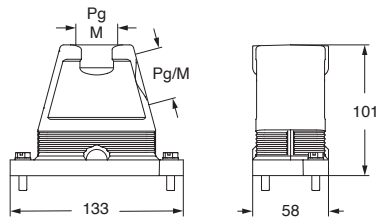


covers

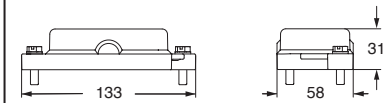


description	part No.	entry Pg	part No	entry M	part No.
with side entry					
size "44.27"	CGO 06.16	16	MGO 06.25	25	
size "44.27"	CGO 06.21	21	MGO 06.32	32	
size "44.27"	CGO 06.29	29			
with top entry					
size "44.27"	CGV 06.16	16	MGV 06.25	25	
size "44.27"	CGV 06.21	21	MGV 06.32	32	
size "44.27"	CGV 06.29	29	MGV 06.40	40	
size "44.27"					CGC 06

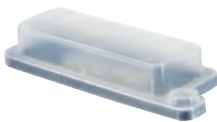
CGO/MGO and CGV/MGV



CGC



CGCP MB
Dust protection cover
(from page 697)



CUUS® Type 4/4X/12



according to IEC/EN 60529

CG high protection IP68 version (bayonet locking)

inserts		page:
CDD	24 poles + ⊕	76
CDS	9 poles + ⊕	-
CDSH	9 poles + ⊕	86
CDSH NC	6 poles + ⊕	95
CNE	6 poles + ⊕	110
CSE	6 poles + ⊕	-
CSH	6 poles + ⊕	110
CSH S	6 poles + ⊕	122
CCE	6 poles + ⊕	130
CSS	6 poles + ⊕	148
CQE	10 poles + ⊕	168
MIXO	2 modules	262 - 317

bulkhead mounting housings



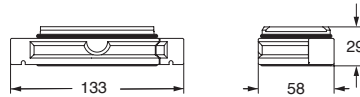
description

part No.

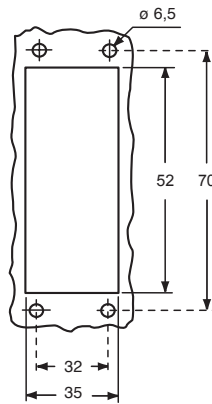
with gasket, size "44.27"

CGI 06 B

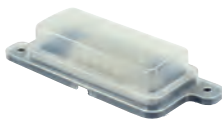
CGI B



panel cut-out for bulkhead mounting housings



CGCP FX
Dust protection
cover
(from page 697)



CAUS® Type
4/4X/12



according to IEC/EN 60529

CG and MG high protection IP68 version (bayonet locking)

inserts		page:
CDD	24 poles + ⊕	76
CDS	9 poles + ⊕	-
CDSH	9 poles + ⊕	86
CDSH NC	6 poles + ⊕	95
CNE	6 poles + ⊕	110
CSE	6 poles + ⊕	-
CSH	6 poles + ⊕	110
CSH S	6 poles + ⊕	122
CCE	6 poles + ⊕	130
CSS	6 poles + ⊕	148
CQE	10 poles + ⊕	168
MIXO	2 modules	262 - 317

hoods



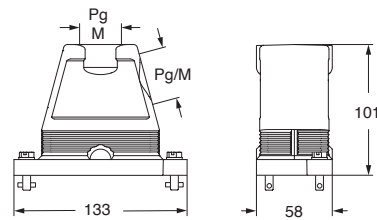
covers



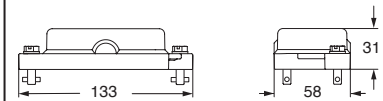
description	part No.	entry Pg	part No	entry M	part No.
with side entry					
size "44.27"	CGO 06.16 B	16	MGO 06.25 B	25	
size "44.27"	CGO 06.21 B	21	MGO 06.32 B	32	
size "44.27"	CGO 06.29 B	29			
with top entry					
size "44.27"	CGV 06.16 B	16	MGV 06.25 B	25	
size "44.27"	CGV 06.21 B	21	MGV 06.32 B	32	
size "44.27"	CGV 06.29 B	29	MGV 06.40 B	40	

CGC 06 B

CGO/MGO B and CGV/MGV B



CGC B



CGCP MB
Dust protection cover
(from page 697)



CUUS® Type 4/4X/12



according to IEC/EN 60529

CG and MG high protection IP68 version (screw locking)

inserts		page:
CDD	42 poles + ⊕	78
CDS	18 poles + ⊕	-
CDSH	18 poles + ⊕	87
CNE	10 poles + ⊕	111
CSE	10 poles + ⊕	-
CSH	10 poles + ⊕	111
CSH S	10 poles + ⊕	123
CCE	10 poles + ⊕	131
CMSH	3+2 (aux) poles + ⊕	136
CMCE	3+2 (aux) poles + ⊕	137
CSS	10 poles + ⊕	149
CQE	18 poles + ⊕	169
CX	8/24 poles + ⊕	194
MIXO	3 modules	262 - 317

bulkhead mounting housings

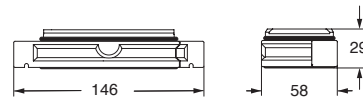


surface mounting housings

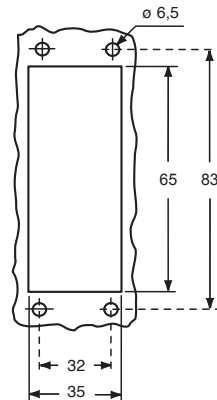


description	part No.	part No.	entry Pg	part No.	entry M
with gasket, size "57.27"	CGI 10	CGP 10.29	29	MGP 10.32	32
size "57.27"					

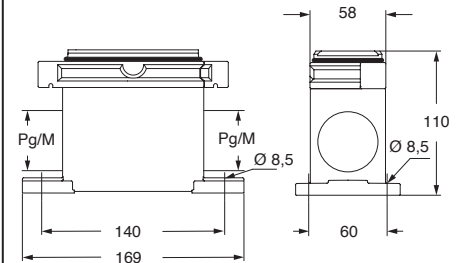
CGI



panel cut-out for bulkhead mounting housings



CGP and MGP



CGCP FX
Dust protection
cover
(from page 697)



CAUS® Type
4/4X/12



according to IEC/EN 60529

CG and MG high protection IP68 version (screw locking)

inserts		page:
CDD	42 poles + ⊕	78
CDS	18 poles + ⊕	-
CDSH	18 poles + ⊕	87
CNE	10 poles + ⊕	111
CSE	10 poles + ⊕	-
CSH	10 poles + ⊕	111
CSH S	10 poles + ⊕	123
CCE	10 poles + ⊕	131
CMSH	3+2 (aux) poles + ⊕	136
CMCE	3+2 (aux) poles + ⊕	137
CSS	10 poles + ⊕	149
CQE	18 poles + ⊕	169
CX	8/24 poles + ⊕	194
MIXO	3 modules	262 - 317

hoods



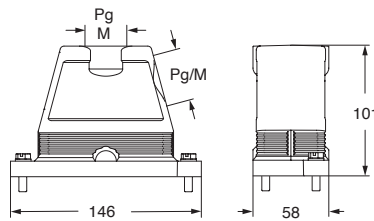
covers



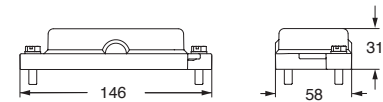
description	part No.	entry Pg	part No	entry M	part No.
with side entry					
size "57.27"	CGO 10.16	16	MGO 10.25	25	
size "57.27"	CGO 10.21	21	MGO 10.32	32	
size "57.27"	CGO 10.29	29			
with top entry					
size "57.27"	CGV 10.16	16	MGV 10.25	25	
size "57.27"	CGV 10.21	21	MGV 10.32	32	
size "57.27"	CGV 10.29	29	MGV 10.40	40	

CGC 10

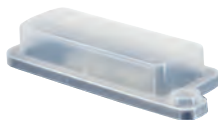
CGO/MGO and CGV/MGV



CGC



CGCP MB
Dust protection cover
(from page 697)



CUUS® Type 4/4X/12



according to IEC/EN 60529

CG high protection IP68 version (bayonet locking)

inserts		page:
CDD	42 poles + ⊕	78
CDS	18 poles + ⊕	-
CDSH	18 poles + ⊕	87
CNE	10 poles + ⊕	111
CSE	10 poles + ⊕	-
CSH	10 poles + ⊕	111
CSH S	10 poles + ⊕	123
CCE	10 poles + ⊕	131
CMSH	3+2 (aux) poles + ⊕	136
CMCE	3+2 (aux) poles + ⊕	137
CSS	10 poles + ⊕	149
CQE	18 poles + ⊕	169
CX	8/24 poles + ⊕	194
MIXO	3 modules	262 - 317

bulkhead mounting housings



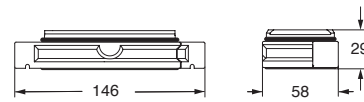
description

part No.

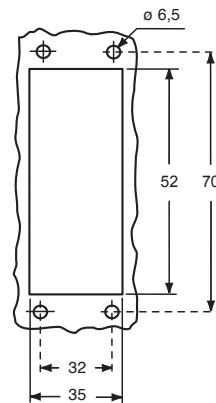
with gasket, size "57.27"

CGI 10 B

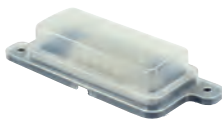
CGI B



panel cut-out for bulkhead mounting housings



CGCP FX
Dust protection
cover
(from page 697)



CAUS® Type
4/4X/12



according to IEC/EN 60529

CG and MG high protection IP68 version (bayonet locking)

inserts		page:
CDD	42 poles + ⊕	78
CDS	18 poles + ⊕	-
CDSH	18 poles + ⊕	87
CNE	10 poles + ⊕	111
CSE	10 poles + ⊕	-
CSH	10 poles + ⊕	111
CSH S	10 poles + ⊕	123
CCE	10 poles + ⊕	131
CMSH	3+2 (aux) poles + ⊕	136
CMCE	3+2 (aux) poles + ⊕	137
CSS	10 poles + ⊕	149
CQE	18 poles + ⊕	169
CX	8/24 poles + ⊕	194
MIXO	3 modules	262 - 317

hoods

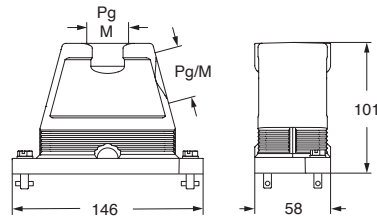


covers

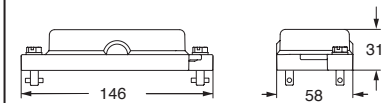


description	part No.	entry Pg	part No	entry M	part No.
with side entry					
size "57.27"	CGO 10.16 B	16	MGO 10.25 B	25	
size "57.27"	CGO 10.21 B	21	MGO 10.32 B	32	
size "57.27"	CGO 10.29 B	29			
with top entry					
size "57.27"	CGV 10.16 B	16	MGV 10.25 B	25	
size "57.27"	CGV 10.21 B	21	MGV 10.32 B	32	
size "57.27"	CGV 10.29 B	29	MGV 10.40 B	40	
size "57.27"					CGC 10 B

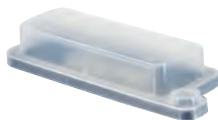
CGO/MGO B and CGV/MGV B



CGC B



CGCP MB
Dust protection cover
(from page 697)



CUUS® Type 4/4X/12



according to IEC/EN 60529

CG and MG high protection IP68 version (screw locking)

inserts		page:
CD	40 poles + ⊕	70
CDD	72 poles + ⊕	79
CDS	27 poles + ⊕	-
CDSH	27 poles + ⊕	88
CNE	16 poles + ⊕	112
CSE	16 poles + ⊕	-
CSH	16 poles + ⊕	112
CSH S	16 poles + ⊕	124
CCE	16 poles + ⊕	132
CMSH, CMCE	6+2 (aux) poles + ⊕	138 - 139
CSS	16 poles + ⊕	150
CQE	32 poles + ⊕	170
CQEE	40 poles + ⊕	176
CP	6 poles + ⊕	178
CX	6/12, 6/36 and 12/2 poles + ⊕	197 - 199
CX	4/0 and 4/2 poles + ⊕	200 - 201
MIXO	4 modules	262 - 317

bulkhead mounting housings

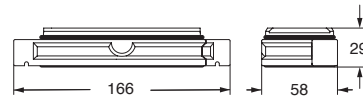


surface mounting housings

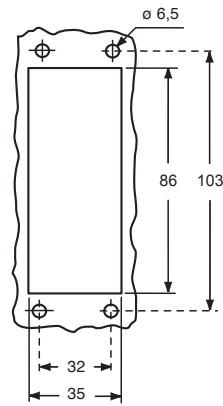


description	part No.	part No.	entry Pg	part No.	entry M
with gasket, size "77.27"	CGI 16				
size "77.27"		CGP 16.36	36	MGP 16.40	40

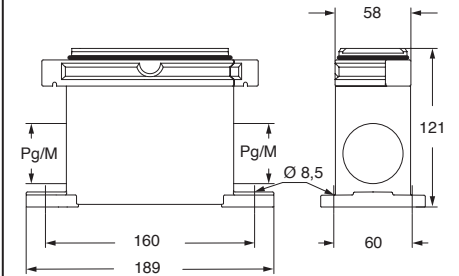
CGI



panel cut-out for bulkhead mounting housings



CGP and MGP



CGCP FX
Dust protection
cover
(from page 697)



CAUS® Type
4/4X/12



according to IEC/EN 60529

CG and MG high protection IP68 version (screw locking)

inserts		page:
CD	40 poles + ⊕	70
CDD	72 poles + ⊕	79
CDS	27 poles + ⊕	-
CDSH	27 poles + ⊕	88
CNE	16 poles + ⊕	112
CSE	16 poles + ⊕	-
CSH	16 poles + ⊕	112
CSH S	16 poles + ⊕	124
CCE	16 poles + ⊕	132
CMSH, CMCE	6+2 (aux) poles + ⊕	138 - 139
CSS	16 poles + ⊕	150
CQE	32 poles + ⊕	170
CQEE	40 poles + ⊕	176
CP	6 poles + ⊕	178
CX	6/12, 6/36 and 12/2 poles + ⊕	197 - 199
CX	4/0 and 4/2 poles + ⊕	200 - 201
MIXO	4 modules	262 - 317

hoods



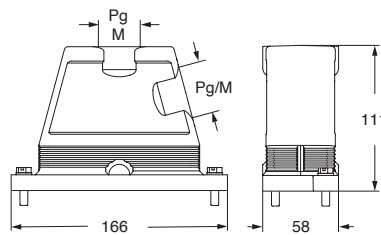
covers



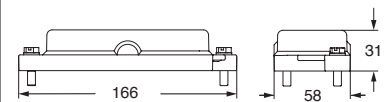
description	part No.	entry Pg	part No	entry M	part No.
with side entry					
size "77.27"	CGO 16.21	21	MGO 16.32	32	
size "77.27"	CGO 16.29	29	MGO 16.40	40	
size "77.27"	CGO 16.36	36	MGO 16.50	50	
with top entry					
size "77.27"			MGV 16.25	25	
size "77.27"			MGV 16.225	25 x 2	
size "77.27"	CGV 16.21	21	MGV 16.32	32	
size "77.27"	CGV 16.221	21 x 2			
size "77.27"	CGV 16.29	29	MGV 16.40	40	
size "77.27"	CGV 16.36	36	MGV 16.50	50	

CGC 16

CGO/MGO and CGV/MGV



CGC



CGCP MB
Dust protection cover
(from page 697)



CUUS® Type 4/4X/12



according to IEC/EN 60529

CG high protection IP68 version (bayonet locking)

inserts		page:
CD	40 poles + ⊕	70
CDD	72 poles + ⊕	79
CDS	27 poles + ⊕	-
CDSH	27 poles + ⊕	88
CNE	16 poles + ⊕	112
CSE	16 poles + ⊕	-
CSH	16 poles + ⊕	112
CSH S	16 poles + ⊕	124
CCE	16 poles + ⊕	132
CMSH, CMCE	6+2 (aux) poles + ⊕	138 - 139
CSS	16 poles + ⊕	150
CQE	32 poles + ⊕	170
CQEE	40 poles + ⊕	176
CP	6 poles + ⊕	178
CX	6/12, 6/36 and 12/2 poles + ⊕	197 - 199
CX	4/0 and 4/2 poles + ⊕	200 - 201
MIXO	4 modules	262 - 317

bulkhead mounting housings



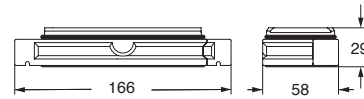
description

part No.

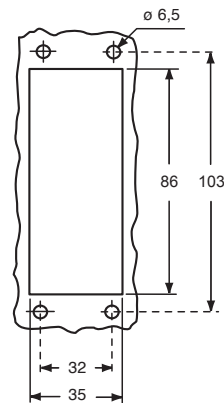
with gasket, size "77.27"

CGI 16 B

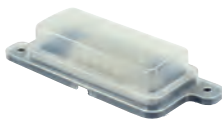
CGI B



panel cut-out for bulkhead mounting housings



CGCP FX
Dust protection
cover
(from page 697)



CAUS® Type
4/4X/12



according to IEC/EN 60529

CG and MG high protection IP68 version (bayonet locking)

inserts		page:
CD	40 poles + ⊕	70
CDD	72 poles + ⊕	79
CDS	27 poles + ⊕	-
CDSH	27 poles + ⊕	88
CNE	16 poles + ⊕	112
CSE	16 poles + ⊕	-
CSH	16 poles + ⊕	112
CSH S	16 poles + ⊕	124
CCE	16 poles + ⊕	132
CMSH, CMCE	6+2 (aux) poles + ⊕	138 - 139
CSS	16 poles + ⊕	150
CQE	32 poles + ⊕	170
CQEE	40 poles + ⊕	176
CP	6 poles + ⊕	178
CX	6/12, 6/36 and 12/2 poles + ⊕	197 - 199
CX	4/0 and 4/2 poles + ⊕	200 - 201
MIXO	4 modules	262 - 317

hoods



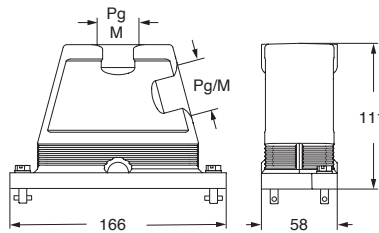
covers



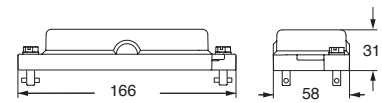
description	part No.	entry Pg	part No	entry M	part No.
with side entry					
size "77.27"	CGO 16.21 B	21	MGO 16.32 B	32	
size "77.27"	CGO 16.29 B	29	MGO 16.40 B	40	
size "77.27"	CGO 16.36 B	36	MGO 16.50 B	50	
with top entry					
size "77.27"			MGV 16.25 B	25	
size "77.27"			MGV 16.225 B	25 x 2	
size "77.27"	CGV 16.21 B	21	MGV 16.32 B	32	
size "77.27"	CGV 16.221 B	21 x 2			
size "77.27"	CGV 16.29 B	29	MGV 16.40 B	40	
size "77.27"	CGV 16.36 B	36	MGV 16.50 B	50	

CGC 16 B

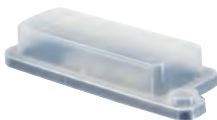
CGO/MGO B and CGV/MGV B



CGC B



CGCP MB
Dust protection cover
(from page 697)



CUUS® Type 4/4X/12



according to IEC/EN 60529

CG and MG high protection IP68 version (screw locking)

inserts		page:
CD	64 poles + ⊕	72
CDD	108 poles + ⊕	81
CDS	42 poles + ⊕	-
CDSH	42 poles + ⊕	89
CNE	24 poles + ⊕	113
CSE	24 poles + ⊕	-
CSH	24 poles + ⊕	113
CSH S	24 poles + ⊕	125
CCE	24 poles + ⊕	133
CMSH	10+2 (aux) poles + ⊕	140
CMCE	10+2 (aux) poles + ⊕	141
CSS	24 poles + ⊕	151
CQE	46 poles + ⊕	171
CQEE	64 poles + ⊕	177
CX	4/8 and 6/6 poles + ⊕	204, 206
MIXO	6 modules	262 - 317

bulkhead mounting housings

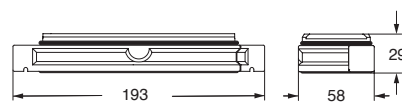


surface mounting housings

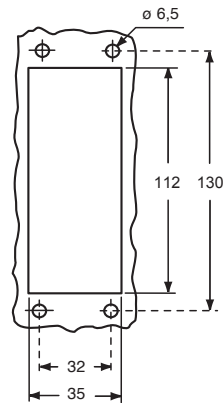


description	part No.	part No.	entry Pg	part No.	entry M
with gasket, size "104.27"	CGI 24				
size "104.27"		CGP 24.36	36	MGP 24.40	40
size "104.27"		CGP 24.236	36 x 2	MGP 24.240	40 x 2

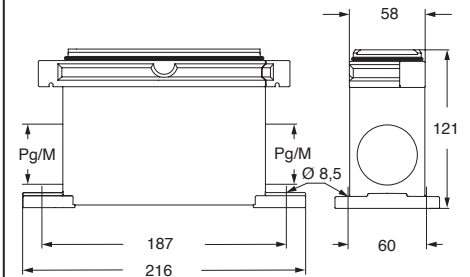
CGI



panel cut-out for bulkhead mounting housings



CGP and MGP



CGCP FX
Dust protection
cover
(from page 697)



CAUS® Type
4/4X/12



according to IEC/EN 60529

CG and MG high protection IP68 version (screw locking)

inserts		page:
CD	64 poles + ⊕	72
CDD	108 poles + ⊕	81
CDS	42 poles + ⊕	-
CDSH	42 poles + ⊕	89
CNE	24 poles + ⊕	113
CSE	24 poles + ⊕	-
CSH	24 poles + ⊕	113
CSH S	24 poles + ⊕	125
CCE	24 poles + ⊕	133
CMSH	10+2 (aux) poles + ⊕	140
CMCE	10+2 (aux) poles + ⊕	141
CSS	24 poles + ⊕	151
CQE	46 poles + ⊕	171
CQEE	64 poles + ⊕	177
CX	4/8 and 6/6 poles + ⊕	204, 206
MIXO	6 modules	262 - 317

hoods

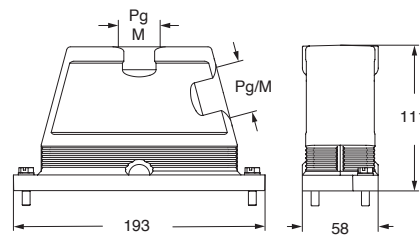


covers

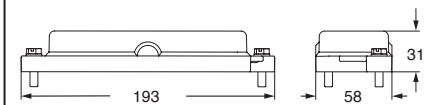


description	part No.	entry Pg	part No.	entry M	part No.
with side entry					
size "104.27"	CGO 24.21	21	MGO 24.32	32	
size "104.27"	CGO 24.29	29	MGO 24.40	40	
size "104.27"	CGO 24.36	36	MGO 24.50	50	
with top entry					
size "104.27"			MGV 24.325	25 x 3	
size "104.27"	CGV 24.21	21	MGV 24.32	32	
size "104.27"			MGV 24.232	32 x 2	
size "104.27"	CGV 24.29	29	MGV 24.40	40	
size "104.27"	CGV 24.229	29 x 2	MGV 24.240	40 x 2	
size "104.27"	CGV 24.36	36	MGV 24.50	50	
size "104.27"					CGC 24

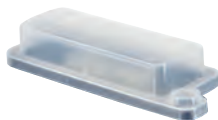
CGO/MGO and CGV/MGV



CGC



CGCP MB
Dust protection cover
(from page 697)



CUUS Type 4/4X/12



according to IEC/EN 60529

CG high protection IP68 version (bayonet locking)

inserts		page:
CD	64 poles + ⊕	72
CDD	108 poles + ⊕	81
CDS	42 poles + ⊕	-
CDSH	42 poles + ⊕	89
CNE	24 poles + ⊕	113
CSE	24 poles + ⊕	-
CSH	24 poles + ⊕	113
CSH S	24 poles + ⊕	125
CCE	24 poles + ⊕	133
CMSH	10+2 (aux) poles + ⊕	140
CMCE	10+2 (aux) poles + ⊕	141
CSS	24 poles + ⊕	151
CQE	46 poles + ⊕	171
CQEE	64 poles + ⊕	177
CX	4/8 and 6/6 poles + ⊕	204, 206
MIXO	6 modules	262 - 317

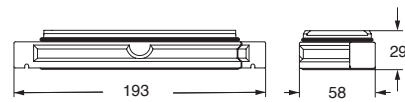
bulkhead mounting housings



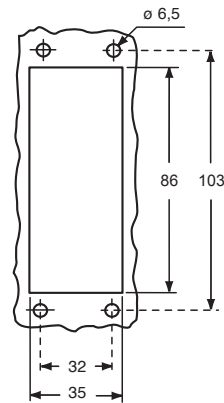
description	part No.
-------------	----------

with gasket, size "104.27" **CGI 24 B**

CGI B



panel cut-out for bulkhead mounting housings



CGCP FX
Dust protection
cover
(from page 697)



CAUS® Type
4/4X/12



according to IEC/EN 60529

IP68

CG and MG high protection IP68 version (bayonet locking)

inserts		page:
CD	64 poles + ⊕	72
CDD	108 poles + ⊕	81
CDS	42 poles + ⊕	-
CDSH	42 poles + ⊕	89
CNE	24 poles + ⊕	113
CSE	24 poles + ⊕	-
CSH	24 poles + ⊕	113
CSH S	24 poles + ⊕	125
CCE	24 poles + ⊕	133
CMSH	10+2 (aux) poles + ⊕	140
CMCE	10+2 (aux) poles + ⊕	141
CSS	24 poles + ⊕	151
CQE	46 poles + ⊕	171
CQEE	64 poles + ⊕	177
CX	4/8 and 6/6 poles + ⊕	204, 206
MIXO	6 modules	262 - 317

hoods



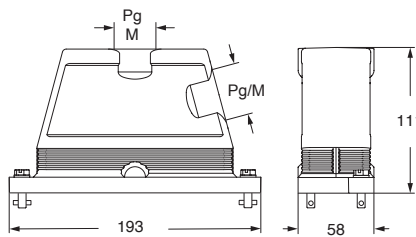
covers



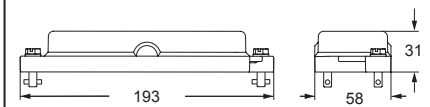
description	part No.	entry Pg	part No.	entry M	part No.
with side entry					
size "104.27"	CGO 24.21 B	21	MGO 24.32 B	32	
size "104.27"	CGO 24.29 B	29	MGO 24.40 B	40	
size "104.27"	CGO 24.36 B	36	MGO 24.50 B	50	
with top entry					
size "104.27"			MGV 24.325 B	25 x 3	
size "104.27"	CGV 24.21 B	21	MGV 24.32 B	32	
size "104.27"			MGV 24.232 B	32 x 2	
size "104.27"	CGV 24.29 B	29	MGV 24.40 B	40	
size "104.27"	CGV 24.229 B	29 x 2	MGV 24.240 B	40 x 2	
size "104.27"	CGV 24.36 B	36	MGV 24.50 B	50	

CGC 24 B

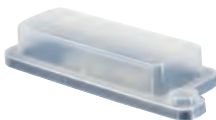
CGO/MGO B and CGV/MGV B



CGC B



CGCP MB
Dust protection cover
(from page 697)



CUUS Type 4/4X/12



according to IEC/EN 60529

CG..FL counterflanges high protection IP68 version

bulkhead mounting housings:

- size "44.27"
- size "57.27"
- size "77.27"
- size "104.27"

page:

- 632 - 635
- 636 - 639
- 640 - 643
- 644 - 647

counterflanges
for bulkhead mounting housings

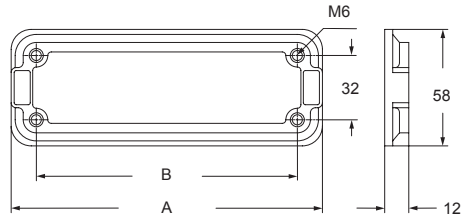


description

part No.

- size "44.27"
- size "57.27"
- size "77.27"
- size "104.27"

- CG 06 FL**
- CG 10 FL**
- CG 16 FL**
- CG 24 FL**



part No.	A	B
CG 06 FL	96	70
CG 10 FL	109	83
CG 16 FL	129	103
CG 24 FL	156	130

IP68



Type
4/4X/12



COB series

Functionality counts

The **COB** system of panel supports makes it possible to use multipole connectors within electric panels without the traditional metallic enclosures as protection is assured by the electric panel itself or other container.

N.B.: Connectors must not be connected and disconnected under load or when live.

The **COB** system is approved by **UL** as support for multipole connectors (UL ECBT2 and ECBT8 file E115072), as well as by **DNV-GL** and **Bureau Veritas** maritime applications on board ships.

The **COB** system may be assembled in the three following ways:

- On panels with window snap fastening device (**Figure 1**).
- On DIN EN 60715 rails, both lengthways and crossways to the support (**Figure 2**).
- On fixed panels using screws (**Figure 2**).

SUM-UP

- ☑ **reduction in cost and space with respect to metallic enclosures plus traditional terminal blocks enabling “modular” wiring inside panels, very handy in case of maintenance: fast replacement of devices and entire sections leading to shorter downtime;**
- ☑ **possibility of pre-wiring and testing of the connectors at bench, fastening the commissioning of the installation on site;**
- ☑ **easy wiring inspection and tests with coupled connectors, thanks to rear access to the inserts by the overturning (connector hinged and locked on the base support);**
- ☑ **fast mounting in panels thanks to the snap fastening device on the DIN EN 60715 rails;**
- ☑ **sturdy support structure, specific to the size of each insert, it does not require any preparation;**
- ☑ **broad passage for housing of conductor cables;**
- ☑ **mobile parts prearranged for the clamping of bundles of conductors of multi-core cables, to prevent contact with the connector contacts.**

The COB system satisfies the most varied installation needs thanks to the interchangeability of the connector inserts. The inserts can be installed as per the table aside.

In addition, the **COB...BC** supports may house the ILME **CR..AD1** and **CR..AD2** series plates for the D-SUB inserts (miniature-connectors).

Product details

- 1 **COB, TSF** or **COB TSFS** insert support blocks (with cable clamp) for mobile mounting, in self-extinguishing thermoplastic material.
- 2 Passage for cable support bands (from 2,2 to 4,8 mm).
- 3 Locations for insertion of identification tags (size 9 x 20 mm).
- 4 Threaded metallic inserts for screws to fix the connectors and possibility of coded connection with the use of specific pins (ILME part: CR 20, CRM, CRF, CR 20 CX, CRM CX and CRF CX) when identical connectors are used.
- 5 **COB TCQ** insert carrier block for window mounting in self-extinguishing thermoplastic material, with spring snap fastening.
- 6 Locking device with levers in self-extinguishing thermoplastic material for insert coupling.
- 7 Sturdy cable clamp for clamping multipolar cables with a diameter of up to 25 mm or bundles of unipolar conductors.
- 8 **COB..CMS** enclosure for mobile mounting, in self-extinguishing thermoplastic material, IP20 degree of protection.
- 9 Free passage for mounting wired insert with conductor cables.
- 10 Releasable block (latch actuated by pushbutton) [in **COB..BC** kit] in self-extinguishing thermoplastic material, with quick release device for insert turnover, wiring operations, verifications and maintenance
- 11 **COB..BC** panel support for bulkhead mounting in self-extinguishing thermoplastic material, sturdy block support structure, with broad passage for housing of conductor cables.
- 12 Holes for fixed fastening with screws without DIN EN 60715 rails.
- 13 Snap fastening on DIN EN 60715 rails, both lengthways and crossways to the support.
- 14 Rollover pins that can be released and allow the use of pre-wired inserts.

Supports for connector inserts

types	COB TCQ			
	fixed	COB 06 BC	COB 10 BC	COB 16 BC
types	COB TSF and COB TSFS			
	mobile	COB 06 CMS	COB 10 CMS	COB 16 CMS

Insert centre distance

mm				
			49.5 x 16 *	
	44 x 27	57 x 27	66 x 16 *	
			77.5 x 27	104 x 27

Insert series and polarity + ⊕

CD			15 *, 25 *, 40	64
CDD	24	42	38 *, 72	108
CDA, CSAH			10 *, 16 *	
CDC			10 *, 16 *	
CDSH, CDS	9	18	27	42
CCE	6	10	16	24
CQE	10	18	32	46
CQEE			40	64
CNE	6	10	16	24
CSH, CSE	6	10	16	24
CMCE		3+2	6+2	10+2 / 16+2
CME		3+2	6+2	10+2 / 16+2
CMSH		3+2	6+2	10+2
CP			6	
CX			4/0, 4/2, 6/36, 12/2	4/8, 6/6
MIXO	2 modules	3 modules	4 modules	6 modules

* for mounting via adapter plates, see page 654

Figure 1
COB TCQ + COB TSFS (COB...CMS, alternative)
 - Snap fastening in window **, panels or control panels.

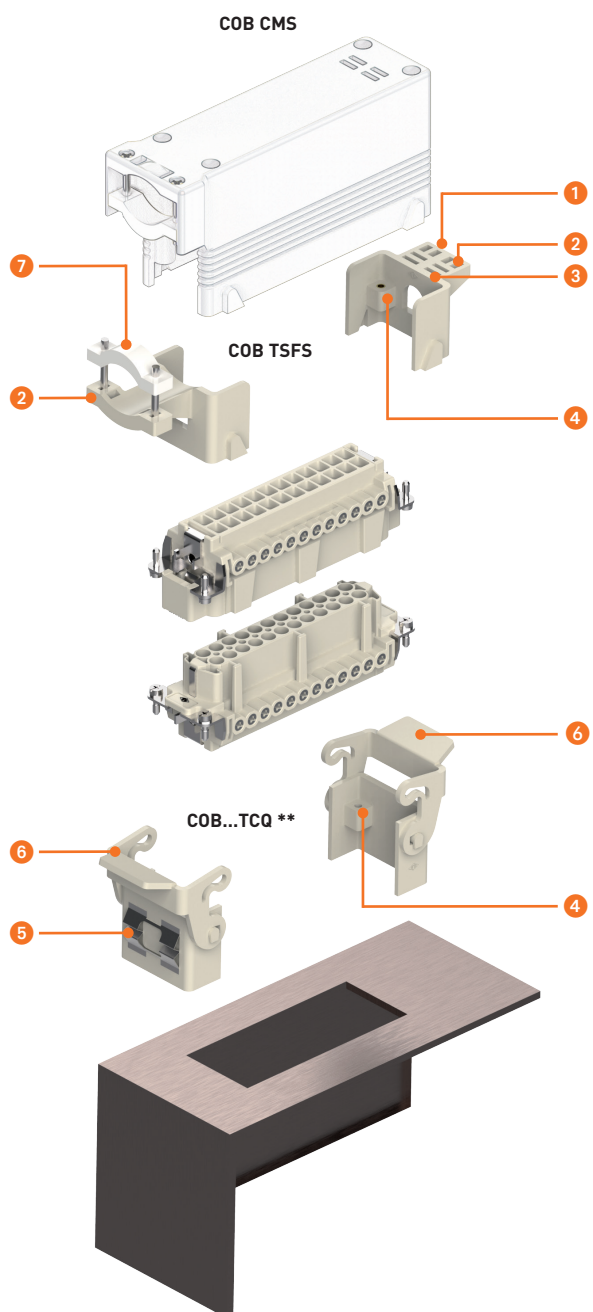
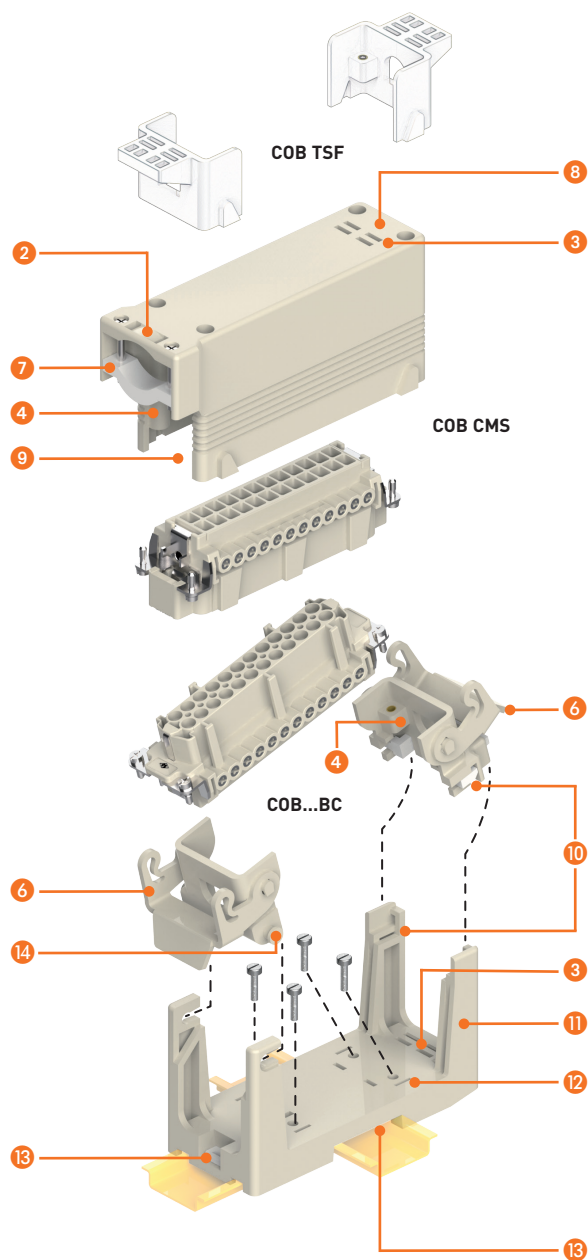


Figure 2
COB..BC + COB..CMS (COB TSF, alternative)
 - Snap fastening on DIN EN 60715 rails both lengthways and crossways to the support;
 - installation in panels or control panels, with fixed fastening with screws.



COB panel supports for multipole connectors

inserts		page:
CD	40, 64 poles + ⊕	70, 72
CDD	24, 42, 72, 108 poles + ⊕	76 - 81
CDS	9, 18, 27, 42 poles + ⊕	-
CDSH	9, 18, 27, 42 poles + ⊕	86 - 89
CDSH NC	6 poles + ⊕	95
CNE	6, 10, 16, 24 poles + ⊕	110 - 113
CSE	6, 10, 16, 24 poles + ⊕	-
CSH	6, 10, 16, 24 poles + ⊕	110 - 113
CSH S	6, 10, 16, 24 poles + ⊕	122 - 125
CCE	6, 10, 16, 24 poles + ⊕	130 - 133
CMSH	3+2, 6+2, 10+2 (aux) poles + ⊕	136 - 140
CMCE	3+2, 6+2, 10+2 (aux) poles + ⊕	137 - 141
CSS	6, 10, 16, 24 poles + ⊕	148 - 151
CQE	10, 18, 32, 46 poles + ⊕	168 - 171
CQEE	40, 64 poles + ⊕	176 - 177
CP	6 poles + ⊕	178
CX	8/24, 6/36, 12/2 poles + ⊕	194 - 199
CX	4/0, 4/2, 4/8, 6/6 poles + ⊕	200 - 206
MIXO	2, 3, 4, 6 modules	262 - 317

connector carrier for faceplate mounting in window, snap fastening



connector carrier baseplate for mounting on DIN EN 60715 rail or fixed mounting using screws



description

part No.

part No.

kit with 2 elements, for coupling of inserts with screw fixing centre distance (short side = 27 mm)

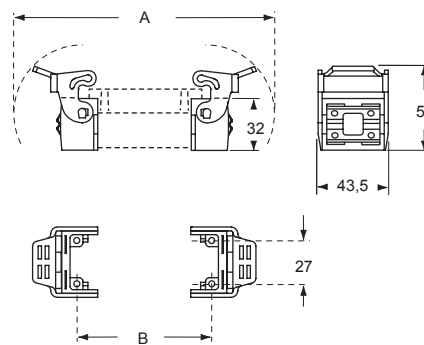
COB TCQ

kit comprising frame and mobile blocks, for insert coupling: with screw fixing centre distance of 44 x 27 mm with screw fixing centre distance of 57 x 27 mm with screw fixing centre distance of 77,5 x 27 mm with screw fixing centre distance of 104 x 27 mm

It is the responsibility of the installer to verify the continuity of the PE protective earth circuit ⊕ between the two halves of the connector.

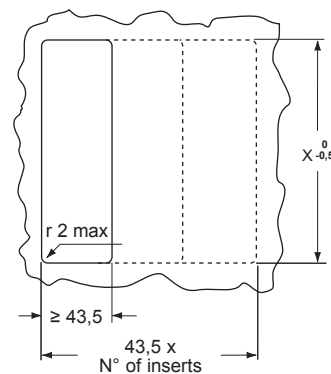
- COB 06 BC
- COB 10 BC
- COB 16 BC
- COB 24 BC

COB TCQ



COB TCQ	A	B
for inserts		
with centre distance 44 x 27 mm	120	44
with centre distance 57 x 27 mm	133	57
with centre distance 77,5 x 27 mm	153,5	77,5
with centre distance 104 x 27 mm	180	104

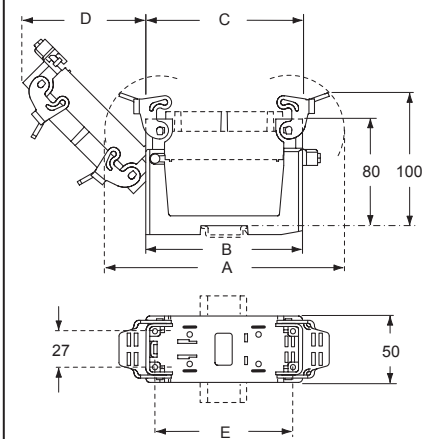
panel cut-out COB TCQ
window size on plate thickness 1,3-3 mm



for insert coupling:	X_{0,5}
with centre distance 44 x 27 mm	65
with centre distance 57 x 27 mm	78
with centre distance 77,5 x 27 mm	98
with centre distance 104 x 27 mm	125

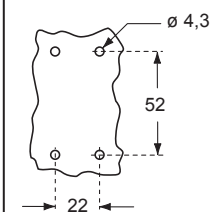
COB BC

overall dimensions with longitudinal DIN rails

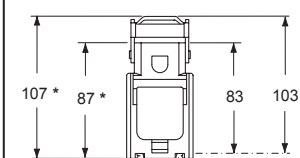


part No.	A	B	C	D	E
COB 06 BC	120	91,5	58	50	44
COB 10 BC	133	91,5	71	59,5	57
COB 16 BC	153,5	91,5	91,5	74	77,5
COB 24 BC	180	118	118	93	104

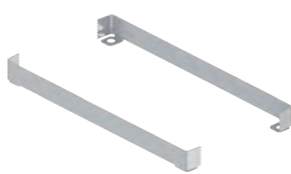
panel cut-out COB BC



overall dimensions without DIN rails (values with "asterisk") overall dimensions with transverse DIN rails



Optional PE earth jumpers (page 655)



COB panel supports for multipole connectors

inserts		page:
CD	40, 64 poles + ⊕	70, 72
CDD	24, 42, 72, 108 poles + ⊕	76 - 81
CDS	9, 18, 27, 42 poles + ⊕	-
CDSH	9, 18, 27, 42 poles + ⊕	86 - 89
CDSH NC	6 poles + ⊕	95
CNE	6, 10, 16, 24 poles + ⊕	110 - 113
CSE	6, 10, 16, 24 poles + ⊕	-
CSH	6, 10, 16, 24 poles + ⊕	110 - 113
CSH S	6, 10, 16, 24 poles + ⊕	122 - 125
CCE	6, 10, 16, 24 poles + ⊕	130 - 133
CMSH	3+2, 6+2, 10+2 (aux) poles + ⊕	136 - 140
CMCE	3+2, 6+2, 10+2 (aux) poles + ⊕	137 - 141
CSS	6, 10, 16, 24 poles + ⊕	148 - 151
CQE	10, 18, 32, 46 poles + ⊕	168 - 171
CQEE	40, 64 poles + ⊕	176 - 177
CP	6 poles + ⊕	178
CX	8/24, 6/36, 12/2 poles + ⊕	194 - 199
CX	4/0, 4/2, 4/8, 6/6 poles + ⊕	200 - 206
MIXO	2, 3, 4, 6 modules	262 - 317

insert carrier blocks for mobile mounting



insert carrier insulated enclosures for mobile mounting



description	part No.	part No.
-------------	----------	----------

kit with 2 elements, for coupling of inserts with screw fixing centre distance (short side = 27 mm) with handle for cable support bands with handle for cable support or cable clamp bands

COB TSF
COB TSFS

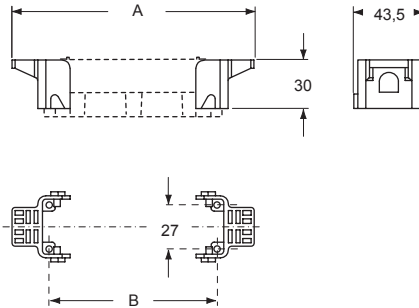
side entry, with cable clamp for insert coupling:

- with screw fixing centre distance of 44 x 27 mm
- with screw fixing centre distance of 57 x 27 mm
- with screw fixing centre distance of 77,5 x 27 mm
- with screw fixing centre distance of 104 x 27 mm

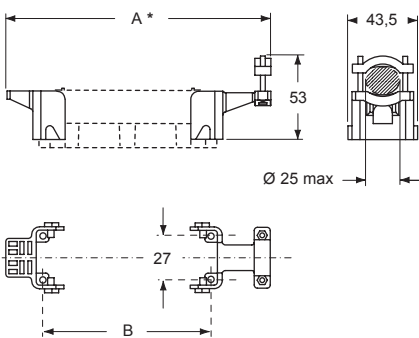
COB 06 CMS
COB 10 CMS
COB 16 CMS
COB 24 CMS

It is the responsibility of the installer to verify the continuity of the PE protective earth circuit ⊕ between the two halves of the connector.

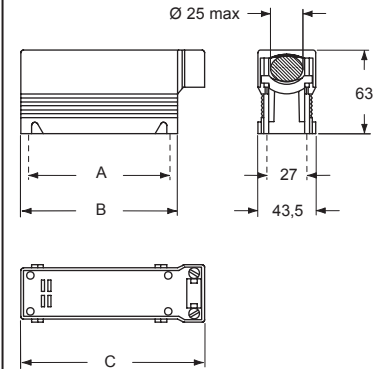
COB TSF



COB TSFS



COB CMS



part No.	A	B	C
COB 06 CMS	44	58	74
COB 10 CMS	57	71	87
COB 16 CMS	77,5	91,5	107,5
COB 24 CMS	104	118	134

Optional PE earth jumpers (page 655)



for inserts	A	A*	B
with centre distance 44 x 27 mm	90	104	44
with centre distance 57 x 27 mm	103	117	57
with centre distance 77,5 x 27 mm	123,5	137,5	77,5
with centre distance 104 x 27 mm	150	164	104

COB panel supports for multipole connectors

inserts		page:
CD	15, 25 poles + ⊕	68 - 69
CDD	38 poles + ⊕	77
CSAH	10, 16 poles + ⊕	99 - 101
CDA	10, 16 poles + ⊕	98 - 100
CDC	10, 16 poles + ⊕	104 - 105
MIXO	1 module	264 - 316

adapter plates for insert mounting



levers for coupling with metallic enclosures



description	part No.	part No.
-------------	----------	----------

mounting on COB series articles (see below)
for 1 insert with centre distance of 49,5 x 16 mm

CR 15/16

mounting on COB series articles (see below)
for 1 insert with centre distance of 66 x 16 mm

CR 25/16

kit with 2 elements, to be mounted instead of the standard
levers to be coupled with: COB TCQ and COB...BC ¹⁾

COB L

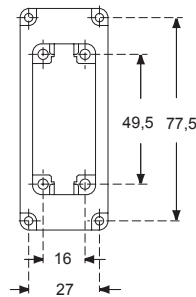
¹⁾ They allow the mounting of aluminium hoods with
4 pegs, size 55.27, 77.27 and 104.27

Adaptor plates

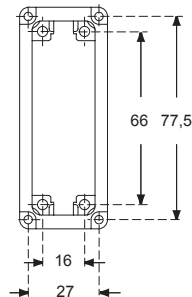
They allow the inserting of inserts of "49.16" and
"66.16" on the following COB series articles:
COB TCQ, COB 16 BC, COB TSF, COB TSFS,
COB 16 CMS

It is the responsibility of the installer to verify the
continuity of the PE protective earth circuit ⊕
between the two halves of the connector.

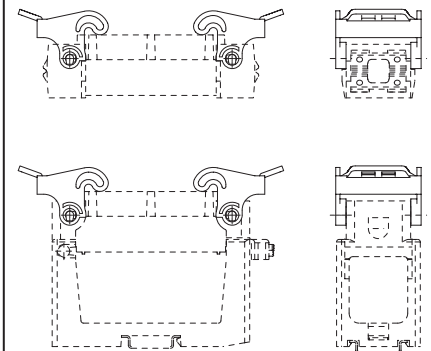
CR 15/16



CR 25/16



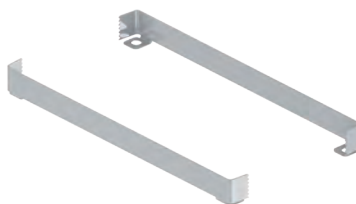
COB L



CR..BPE PE earth jumpers

inserts		page:
CD	40, 64 poles + ⊕	70, 72
CDD	24, 42, 72, 108 poles + ⊕	76 - 81
CDS	9, 18, 27, 42 poles + ⊕	-
CDSH	9, 18, 27, 42 poles + ⊕	86 - 89
CDSH NC	6 poles + ⊕	95
CNE	6, 10, 16, 24 poles + ⊕	110 - 113
CSE	6, 10, 16, 24 poles + ⊕	-
CSH	6, 10, 16, 24 poles + ⊕	110 - 113
CSH S	6, 10, 16, 24 poles + ⊕	122 - 125
CCE	6, 10, 16, 24 poles + ⊕	130 - 133
CMSH	3+2, 6+2, 10+2 (aux) poles + ⊕	136 - 140
CMCE	3+2, 6+2, 10+2 (aux) poles + ⊕	137 - 141
CSS	6, 10, 16, 24 poles + ⊕	148 - 151
CT, CTSE	6, 10, 16, 24 poles + ⊕	160 - 163
CQE	10, 18, 32, 46 poles + ⊕	168 - 171
CQEE	40, 64 poles + ⊕	176 - 177
CP	6 poles + ⊕	178
CX	8/24, 6/36, 12/2 poles + ⊕	194 - 199

PE optional earth jumpers



description	part No.
-------------	----------

galvanized brass, to be optionally used with COB series:
 for inserts "44.27" size
 for inserts "57.27" size
 for inserts "77.27" size
 for inserts "104.27" size

- CR 06 BPE
- CR 10 BPE
- CR 16 BPE
- CR 24 BPE

CR...BPE accessories PE (protective earth) jumpers could be mounted under the connector inserts for the connection of the two insert's PE plates.

To guarantee to proper alignment of the insert inside the enclosure, it is necessary to use both jumpers supplied (in the same housing or hood); the jumpers are not usable individually.

Furthermore the user is responsible for verifying the continuity of the PE connection ⊕ (male and female) independently of using CR...BPE earth jumpers.

CH bulkhead connectors

inserts		page:
CD	40, 64 poles + ⊕	70, 72
CDD	24, 42, 72, 108 poles + ⊕	76 - 81
CDS	9, 18, 27, 42 poles + ⊕	-
CDSH	9, 18, 27, 42 poles + ⊕	86 - 89
CDSH NC	6 poles + ⊕	95
CNE	6, 10, 16, 24 poles + ⊕	110 - 113
CSE	6, 10, 16, 24 poles + ⊕	-
CSH	6, 10, 16, 24 poles + ⊕	110 - 113
CSH S	6, 10, 16, 24 poles + ⊕	122 - 125
CCE	6, 10, 16, 24 poles + ⊕	130 - 133
CMSH	3+2, 6+2, 10+2 (aux) poles + ⊕	136 - 140
CMCE	3+2, 6+2, 10+2 (aux) poles + ⊕	137 - 141
CSS	6, 10, 16, 24 poles + ⊕	148 - 151
CQE	10, 18, 32, 46 poles + ⊕	168 - 171
CQEE	40, 64 poles + ⊕	176 - 177
CP	6 poles + ⊕	178
CX	8/24, 6/36, 12/2 poles + ⊕	194 - 199
CX	4/0, 4/2, 4/8, 6/6 poles + ⊕	200 - 206
MIXO	2, 3, 4, 6 modules	262 - 317

bulkhead mounting housings with 2 or 4 pegs

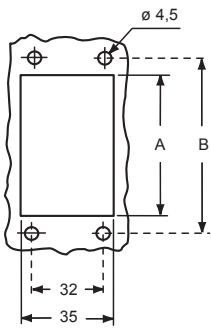


bulkhead mounting housings



description	part No.	part No. C-TYPE	part No. C7
size "44.27"	CHI 06 LCH	CHI 06 L	C71 06 L
size "57.27"	CHI 10 CH ¹⁾	CHI 10	C71 10
size "77.27"	CHI 16 CH ¹⁾	CHI 16	C71 16
size "104.27"	CHI 24 CH ¹⁾	CHI 24	C71 24

panel cut-out for bulkhead mounting housings



part No.	A	B
CHI 06 LCH - CHI 06 L - C71 06 L	52	70
CHI 10 CH - CHI 10 - C71 10	65	83
CHI 16 CH - CHI 16 - C71 16	86	103
CHI 24 CH - CHI 24 - C71 24	112	130

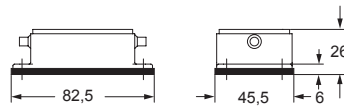
IMPORTANT NOTE: The enclosures ensure IP66 degree of protection when mated and locked with the closing levers.

CAIUS Type 4/4X/12

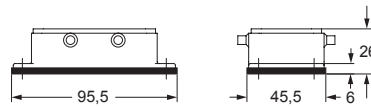


¹⁾ may be combined also with enclosures:
 - surface mounting housings (CHP / MHP...)
 - hoods with lever and gasket (LG)

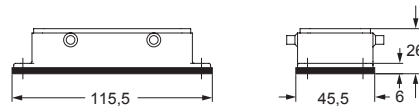
CHI 06 LCH



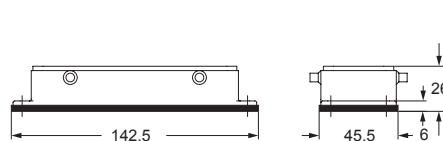
CHI 10 CH



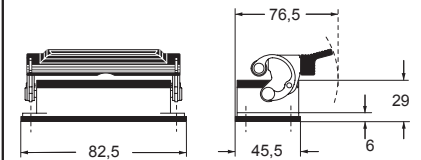
CHI 16 CH



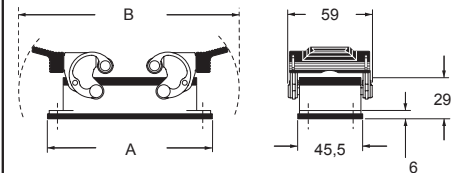
CHI 24 CH



CHI 06 L

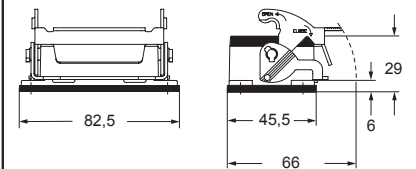


CHI

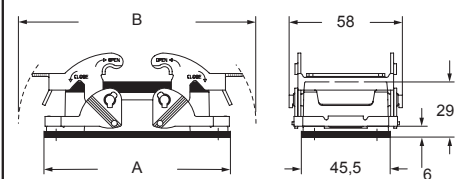


part No.	A	B
CHI 10	95,5	135
CHI 16	115,5	153
CHI 24	142,5	179,5

C71 06 L



C71



part No.	A	B
C71 10	95,5	122
C71 16	115,5	142,5
C71 24	142,5	169

CA bottom entry

inserts		page:
CD	64 poles + ⊕	72
CDD	108 poles + ⊕	81
CDS	42 poles + ⊕	-
CDSH	42 poles + ⊕	89
CNE	24 poles + ⊕	113
CSE	24 poles + ⊕	-
CSH	24 poles + ⊕	113
CSH S	24 poles + ⊕	125
CCE	24 poles + ⊕	133
CMSH	10+2 (aux) poles + ⊕	140
CMCE	10+2 (aux) poles + ⊕	141
CSS	24 poles + ⊕	151
CQE	46 poles + ⊕	171
CQEE	64 poles + ⊕	177
CX	4/8 and 6/6 poles + ⊕	204, 206
MIXO	6 modules	262 - 317

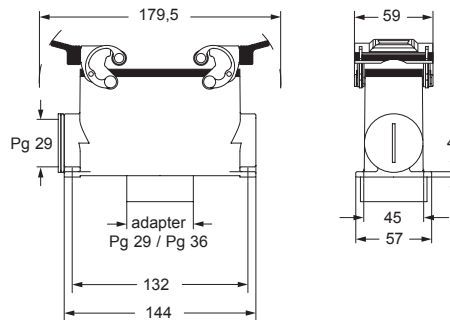
surface mounting housings with 2 levers, bottom entry



description	part No.	entry Pg
with levers, high construction, bottom entry with metal adaptor Pg 29 (hole) / Pg 36 (thread)	CAP 24 G36	36

IMPORTANT NOTE: The enclosures ensure IP66 degree of protection when mated and locked with the closing levers.

CAP G36



CAUS® Type 4/4X/12



insulating cable gland or fittings
without gasket



cable gland
with O-Ring gasket

CYR cable passing hoods

enclosures:

size "77.27"
size "104.27"

Note:
cannot be used with T-TYPE series

cable passing hoods



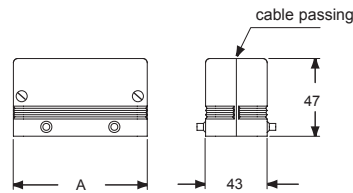
description	part No.	size
with pegs for two levers	CYR 16.3	77.27
3 holes for round cables Ø 5 - 13.5 mm	CYR 24.4	104.27
4 holes for round cables Ø 5 - 13.5 mm		

CYR enclosures for round cables

The CYR enclosures are used in installations that require a passage for round cables for data transmission (e.g. computers or PLC) via equipment such as command or control panels, ensuring a good condition of the cable connections.

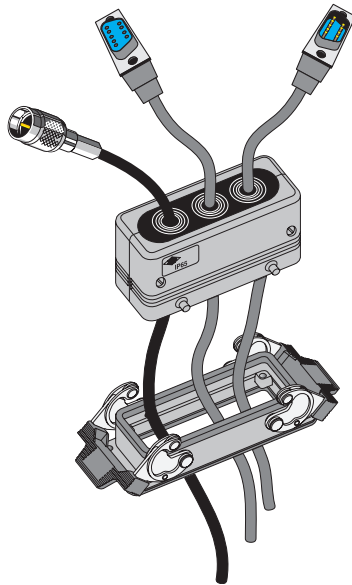
The enclosures are in two parts and have sealing gaskets to preserve the degree of protection of the equipment. The enclosures also contain a rapid cable block device.

The CYR 16.3 and 24.4 can be used with the **bulkhead mounting housings with 2 levers** respectively.



part No.	A	grommet entry	nr.	size
CYR 16.3	93,5	Ø 5 / 13,5	3	77.27
CYR 24.4	120	Ø 5 / 13,5	4	104.27

SPECIAL ENCLOSURES



CAUS® Type 12



CYG in-line joints

enclosures:

size "77.27"

Note:

cannot be used with T-TYPE series and IP68 series

enclosures for in-line joints



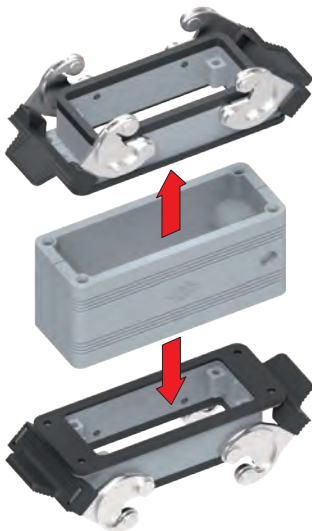
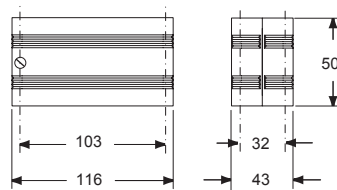
description	part No.
-------------	----------

without housings (to be ordered separately)
made in two halves

CYG 16

CYG 16 in-line joint

- The joint is made with the CYG 16 enclosure and two bulkhead housings "size 77.27" with one or two levers (to be ordered separately).
- The joint is ideal for use with extension connections and/or as adapter.
- Made in two halves to facilitate conductor cabling.
- Two inserts in various combinations may be inserted in the joint (to be ordered separately):
 - female/female inserts (as adapter joint)
 - male/male inserts (as adapter joint)
 - female/male inserts (as extension joint)



CAI[®] US Type 4/4X/12



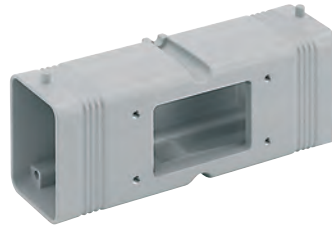
SPECIAL ENCLOSURES

T-BOX branch coupling

enclosures:

size "44.27"
size "57.27"

1 branch-off T-BOX coupling



1 branch-off T-BOX coupling to be fitted on DIN rails



description

part No.

part No.

for 2 **C** hoods with lever and gasket "44.27" size and one housing "44.27" **A** size

CYG 06H06

for 2 **C** hoods with lever and gasket "44.27" size and one housing "57.27" **A** size

CYG 06H10

for 2 **C** hoods with lever and gasket "44.27" size and one housing "44.27" **A** size

CYG 06H06D

for 2 **C** hoods with lever and gasket "44.27" size and one housing "57.27" **A** size

CYG 06H10D

How to use the CYG 06H branch coupling

The cables are branched off by using the CYG 06H coupling in the 1 or 2 branch-off versions. Multi-pole inserts "44.27" size can be fitted inside the two side recesses.

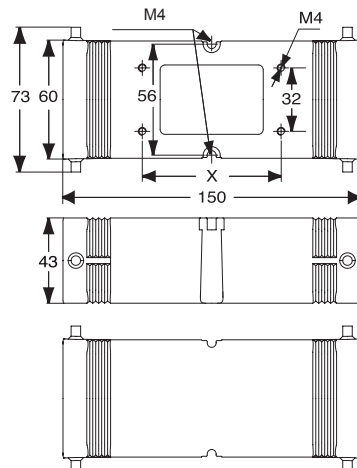
The entire unit can be used with one lever hoods complete with connector inserts.

The front faces can be fitted with "44.27" and/or "57.27" size bulkhead housings.

The coupling may also be used as an adapter by using a combination of different insert versions. The CHC 06 LG cover may be used to close the coupling side faces.

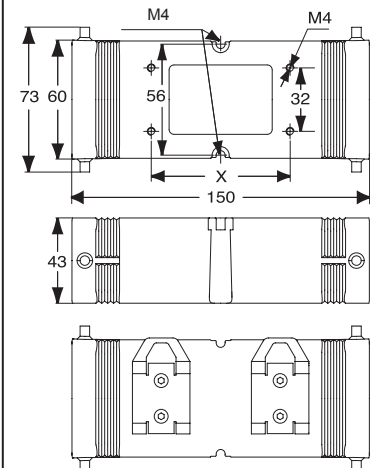
In the branch-offs, the CSS series dual spring terminal inserts allow two wires to be connected without having to fit additional terminals inside the coupling.

CYG...H06 / H10

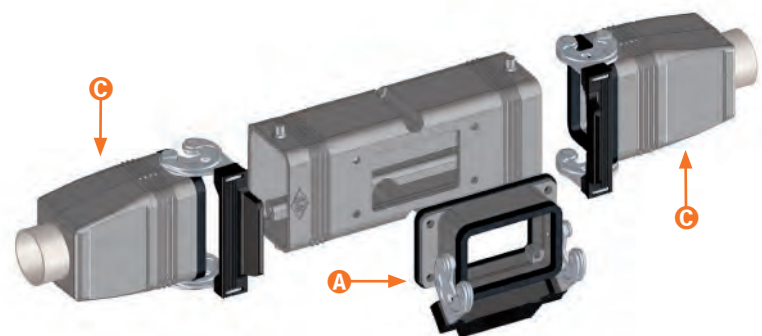


part No.	X
CYG 06H06	70
CYG 06H10	83

CYG...H06D / H10D



part No.	X
CYG 06H06D	70
CYG 06H10D	83



part No.	A	C
CYG 06H06	06	06
CYG 06H10	10	06
CYG 06H06D	06	06
CYG 06H10D	10	06

Legend:

- A** bulkhead mounting housings
- C** hoods with lever and gasket (LG)

CAUS® Type 4/4X/12



SPECIAL ENCLOSURES

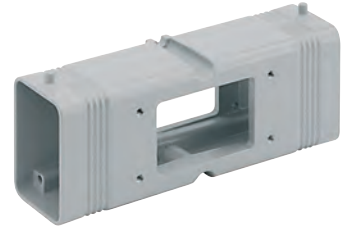
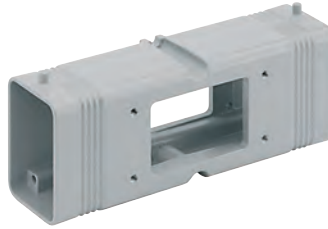
T-BOX branch coupling

enclosures:

size "44.27"
size "57.27"

2 branch-off T-BOX coupling

2 branch-off T-BOX coupling

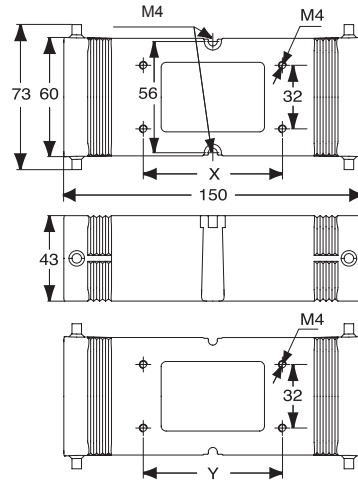


description	part No.	part No.
for 2 C hoods with lever and gasket "44.27" size and one "44.27" B size fixing side housing and one "57.27" A size housing	CYG 06H0610	
for 2 C hoods with lever and gasket "44.27" size and one "57.27" B size fixing side housing and one "44.27" A size enclosure	CYG 06H1006	
for 2 C hoods with lever and gasket "44.27" size and two "44.27" A and B size housing		CYG 06H0606
for 2 C hoods with lever and gasket "44.27" size and two "57.27" A and B size housing		CYG 06H1010

How to use the CYG 06H branch coupling

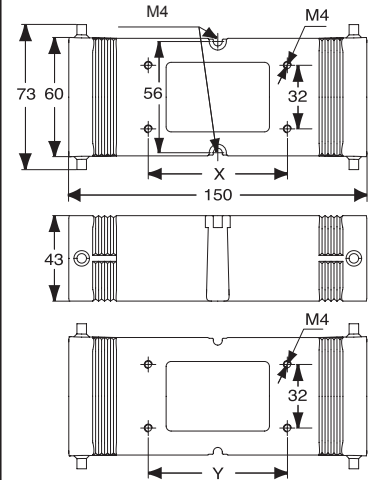
The cables are branched off by using the CYG 06H coupling in the 1 or 2 branch-off versions. Multi-pole inserts "44.27" size can be fitted inside the two side recesses. The entire unit can be used with one lever hoods complete with connector inserts. The front faces can be fitted with "44.27" and/or "57.27" size bulkhead housings. The coupling may also be used as an adapter by using a combination of different insert versions. The CHC 06 LG cover may be used to close the coupling side faces. In the branch-offs, the CSS series dual spring terminal inserts allow two wires to be connected without having to fit additional terminals inside the coupling.

CYG...H0610 / H1006

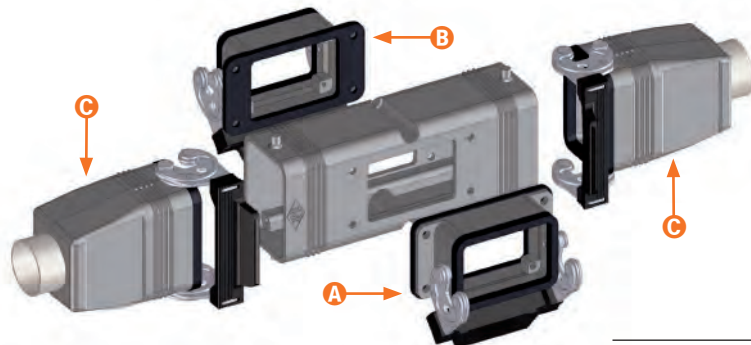


part No.	X	Y
CYG 06H0610	83	70
CYG 06H1006	70	83

CYG...H0606 / H1010



part No.	X	Y
CYG 06H0606	70	70
CYG 06H1010	83	83



CS® Type 4/4X/12



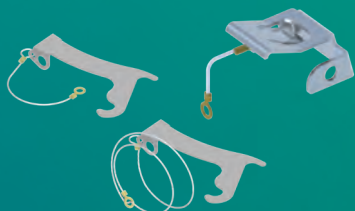
Legend:

- A** bulkhead mounting housings
- B** bulkhead mounting housings
- C** hoods with lever and gasket (LG)

part No.	A	B	C
CYG 06H0610	06	10	06
CYG 06H1006	10	06	06
CYG 06H0606	06	06	06
CYG 06H1010	10	10	06

SPECIAL ENCLOSURES

ACCESSORIES AND TOOLS



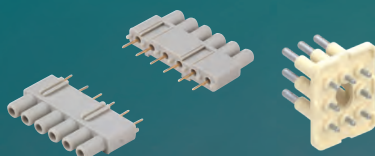
**LOCKING DEVICES
FOR CLASS LOCKING LEVERS,
FOR ENCLOSURES WITH CENTRAL LEVER**.....666 - 667



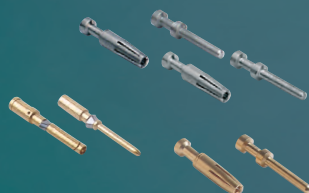
**INSERT FASTENING SCREWS
SCREWS FOR SECOND PROTECTIVE
EARTH TERMINAL** 668



ACCESSORIES FOR CT - CTS - CTSE INSERTS..... 669



CIF PCB ADAPTERS.....670 - 672

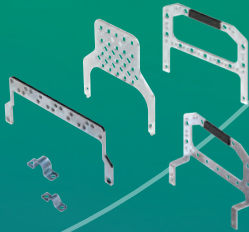


CC CRIMP CONTACTS (CONSTANTAN, IRON)..... 673

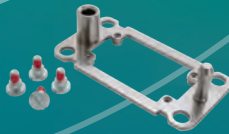
**CD - CDF/M 2D - CDF/M JD (10A)
CC - CCF/M 2D - CCF/M JD (16A)
HIGH THICKNESS AND BASIC GOLD
PLATING CONTACTS**.....674 - 675



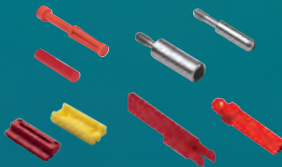
POF CONTACTS CL SERIES676 - 677



CR ANCHORAGES678 - 681



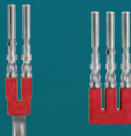
CR...DF SELF-CENTRING FLOATING FRAME 682



CR CODING PINS684 - 692



CKM, CQAM TERMINATION CONNECTOR 693



CR BRIDGES FOR DELTA OR STAR CONNECTION694 - 695



CHCP, CGKCP, CGCP, PROTECTION COVERS696 - 697



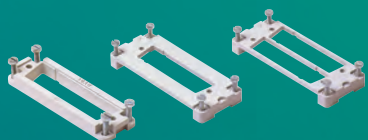
CBGF INSERT JOINING BLOCK 698

CR TM-1 METAL REPLACEMENT HANDLES 698



**CPT TEMPORARY PROTECTION COVER
FOR TRANSPORTATION**

CPES PLIERS FOR UNCOUPLING CONNECTORS 699



**CR...AD - CR...AD1 - CR...AD2 PLATES
FOR D-SUB INSERTS..... 700**



SDS - CHSDS KIT FOR CONTROL EQUIPMENT 701



CRH - CRZ CLOSURE AND REDUCTION PLATE 702



**CX BES EXTRACTION TOOL
FOR MIXO BUS CONNECTORS 703**



CRIMPING TOOLS 704 - 741

CR CLK locking device for CLASS locking levers

enclosures		page:
CHI	10/16/24 poles + ⊕	393, 402, 412
CHP and MHP	10/16/24 poles + ⊕	394, 403, 413

stainless steel locking device
for two-lever housings



padlock, 40 mm arc clearance,
optional



description	part No.	part No.
-------------	----------	----------

stainless steel locking device, with eyelet,
for fixing on the housings

CR CLK

padlock, supplied with 2 keys

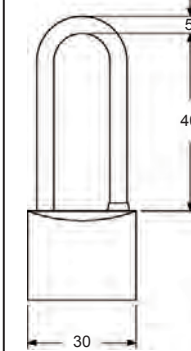
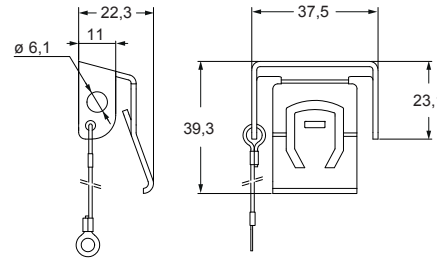
TM BLC125

NOTE: Not suitable neither for hoods with locking levers and gasket nor for surface-mounting housings, high profile.

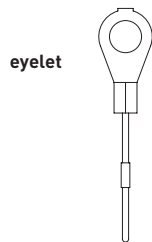
- Locking device, made in stainless steel, that can be easily placed on the "Class" locking lever handle of a two-lever bulkhead mounting housing or a "low profile" surface mounting housing of sizes "57.27", "77.27" and "104.27", in order to avoid unwanted and potentially hazardous accidental opening of the locking lever while the connectors are under working condition;

- possibility to apply, optionally, a padlock (TM BLC125, separately available, 5 mm shackle diameter, 40 mm arc clearance) with anti-tamper function, i.e. to secure the locking against unauthorized attempts to open the locking lever and disconnect the connector coupling;

- with eyelet cord end, for fastening the locking device to the intended housing when not in use.



For fixing on housings



Anti-tamper function by TM BLC125 padlock (to be ordered separately)



CR YLK24 – CR YLK24 SL CENTRAL LEVER

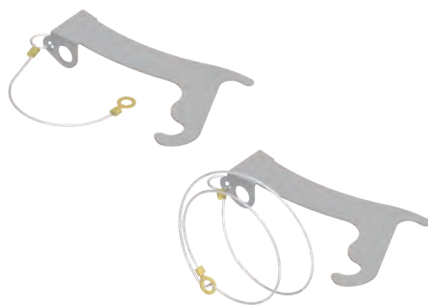
enclosures

Central lever size "104.27"

page:

612 - 614

locking device
for enclosure with central lever
size "104.27"

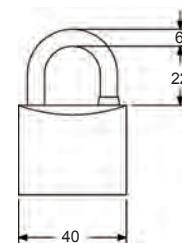
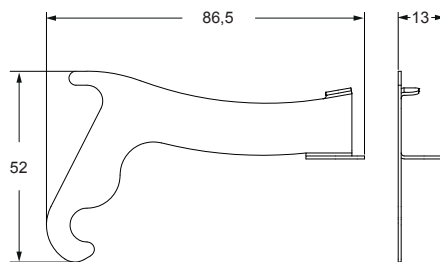


padlock, 22 mm arc clearance,
optional

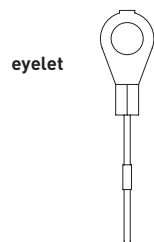


description	part No. (with eyelet)	part No. (with loop)	part. No.
locking device with eyelet for fixing on housings	CR YLK24		
locking device with loop for fixing on hoods		CR YLK24 SL	
padlock, supplied with 2 keys			CR BLC622

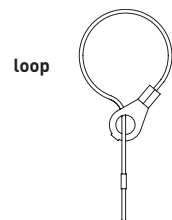
CR YLK24 and CR YLK24 SL



For fixing on housings



For fixing on hoods



screws

insert fastening screws



screws for second protective earth terminal (PE)



description

part No.

part No.

to be fitted instead of the current insert fastening screws ¹⁾

CRIC M3

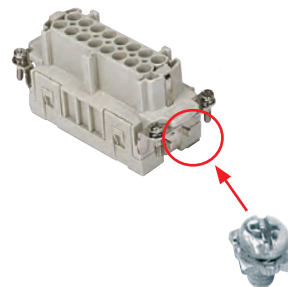
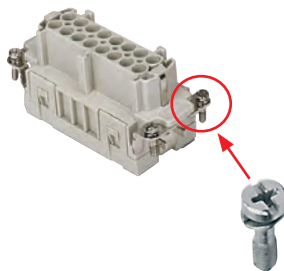
for CDA/CDC, CSAH inserts
 for CD 15/25, CDD 38 inserts
 for CD 40/64, CDD 24/42/72/108, CQE, CQEE, CNE, CSS,
 CX 8/24, CCE, CMSH, CME, CMCE, CSH, CDSH inserts
 for CP, CX 12/2, CX 6/36, CX 6/12, CX 4/0, CX 4/2 inserts

CR VATG
CR VDTG
CR VNTG

CR VPTG

¹⁾ The approved method of mounting inserts is by fixing the four screws in an ILME enclosure or housing.

ILME will not be responsible for any different mounting applications. It is the responsibility of the installer to ensure the correct coupling and the continuity of the protective earth contact of the inserts.



for CT, CTS, CTSE inserts

support for rail mounting DIN EN 60715



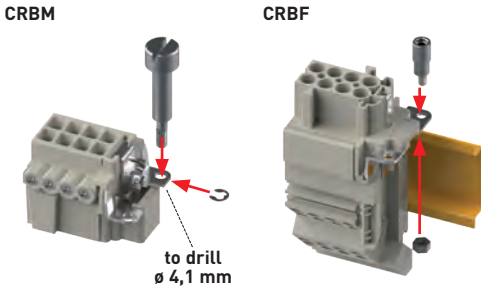
CT/CTS/CTSE inserts coupling screws cable-clamping plates



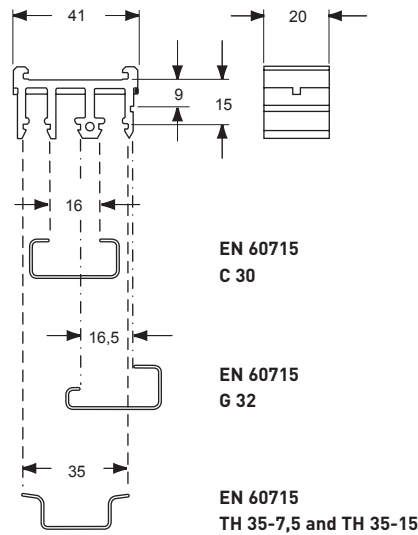
description	part No.	part No.
supports for CT, CTS, CTSE inserts	CT APE	
bush for CT, CTS, CTSE inserts		CRBF
screw pin for CD, CNE, CCE, CSH inserts		CRBM
straight cable clamping plate		CRAD
angled cable clamping plate		CRAS

Coupling screws for CT/CTSE inserts

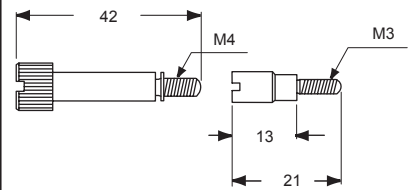
The use of CRBF (female) and CRBM (male coupling screws) is recommended to guarantee a stable and safe coupling between inserts (without enclosures) with terminal blocks and inserts without terminal blocks.



CT APE

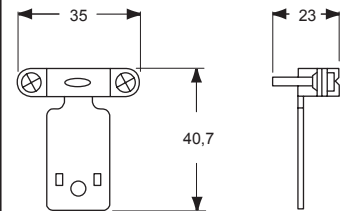


CRBM

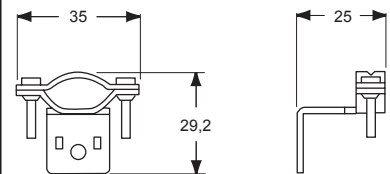


CRBF

CRAD

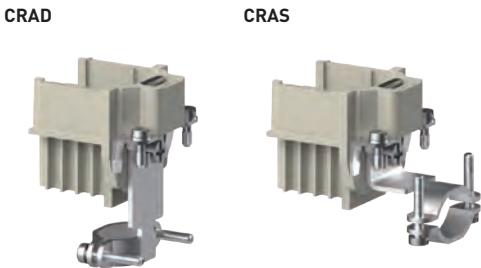


CRAS



Use of cable-clamping plates

In accordance with the recommendations of standard IEC 60352-2, the weight of the conductor groups or multipolar cables must not cause any stress on the contacts inside the inserts. It is therefore advisable to use cable-clamping plates in those inserts without enclosures.

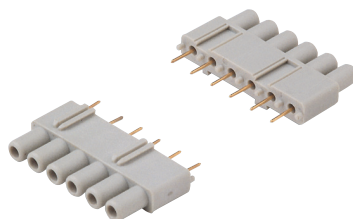


Note:
for conductor groups or cable with
Ø min = 12 mm and Ø max = 23 mm

CIF adattatori PCB

frutti:		pag.:
CDD	24 poli + ⊕	76
CDD	42 poli + ⊕	78
CDD	72 poli + ⊕	79
CDD	108 poli + ⊕	81
CX	8/24 poli + ⊕	194
CX	6/36 poli + ⊕	198
CX 12 (MIXO)	12 poli	281

interfaccia per circuito stampato



contatti argentati e dorati 6 A per interfaccia



descrizione	codice articolo	codice articolo	codice articolo
modulo di interfaccia con 6 contatti femmina (dorati) per PCB fino a 2,4 mm di spessore	CIF 2.4		
modulo di interfaccia con 6 contatti femmina (argentati) per PCB fino a 2,4 mm di spessore	CIF 2.4 A		
contatti femmina 6 A per frutti presa con morsetto Ø 1 mm		CDFA 6A	CDFD 6A
contatti maschio 6 A per frutti spina con morsetto Ø 1 mm		CDMA 6A	CDMD 6A

Interfaccia CIF

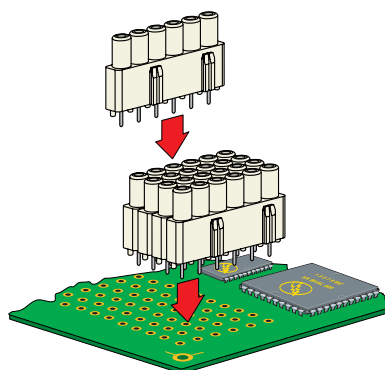
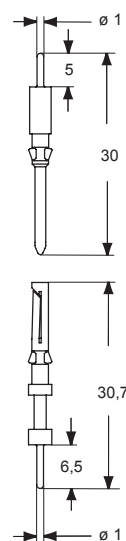
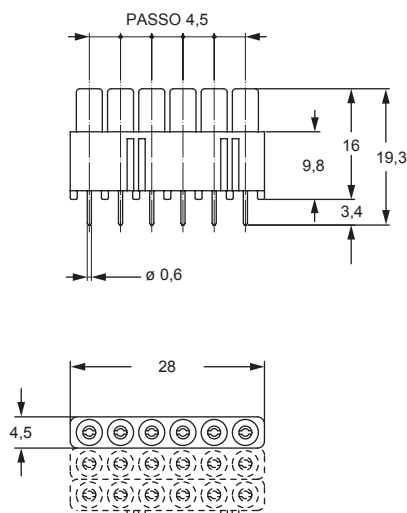
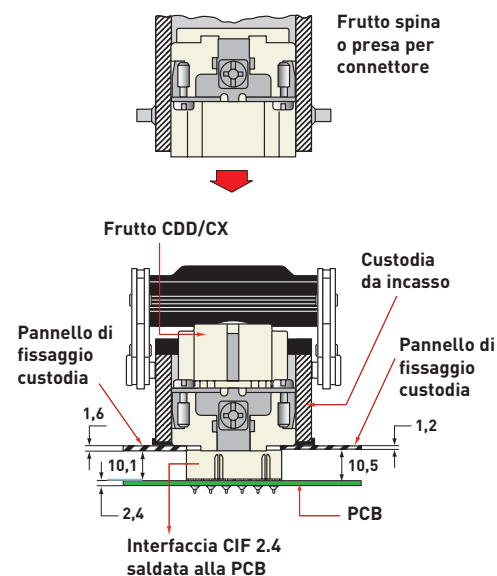
Il blocco di interfaccia viene realizzato secondo il connettore multipolare utilizzato assemblando un numero adeguato di moduli CIF (vedere la tabella).

serie frutti	n. poli	n. moduli "CIF"
CDD	24	4
CDD	42	7
CDD	72	12
CDD	108	18
CX	8/24	4
CX	6/36	6
CX (MIXO)	12	2

Il blocchetto così realizzato viene saldato sul circuito stampato sul quale viene poi inserito il connettore multipolare (femmina o maschio) equipaggiato con gli appositi contatti ad innesto.

ISTRUZIONI DI MONTAGGIO

ADATTATORI PCB CIF 2.4, CIF 2.4 A

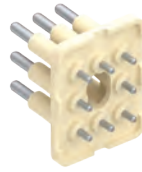


CIF PCB adapters

inserts
 CQ 8 poles + ⊕ page: 192

interface
 for printed circuit

16 A contacts for interface
 silver plated



description	part No.	part No.
-------------	----------	----------

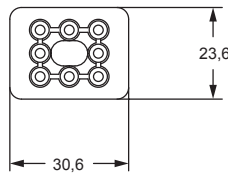
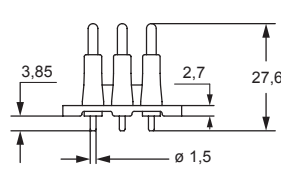
PCB adapter with 8 contacts,
 for up to 1,6 mm thick PCB
 16 A female contacts for female inserts
 16 A male contacts for male inserts

CIF Q08 1.6

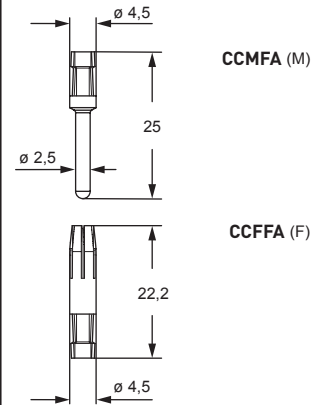
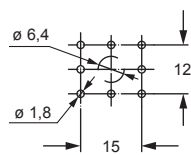
CCFFA silver plated
 CCMFA

The block is soldered on the printed circuit on which the multipole connector (female or male) equipped with coupling contacts will then be inserted.

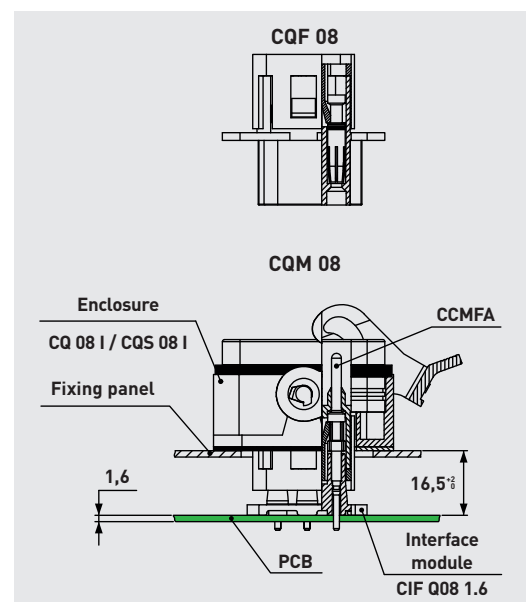
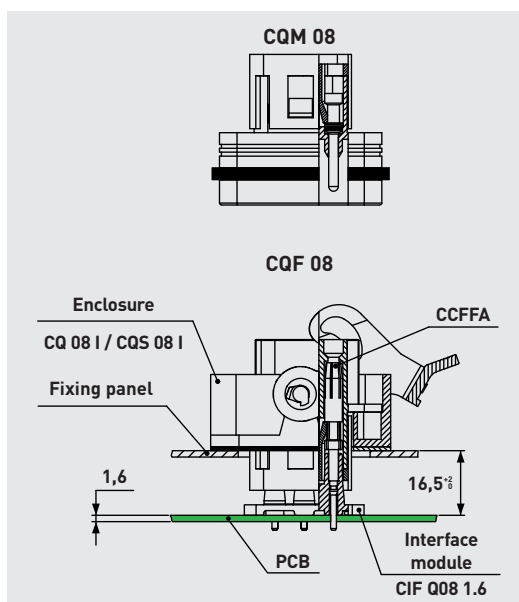
NOTE:
 This PCB interface connector foresees the protective earth connection (PE) of the corresponding CQ 08 connector to be pass-through. For this purpose, a $\varnothing 6,4$ mm hole is foreseen in the PCB layout in correspondence of the PE contact.



PCB-Layout



ASSEMBLY INSTRUCTIONS CIF Q08 1.6 PCB ADAPTERS



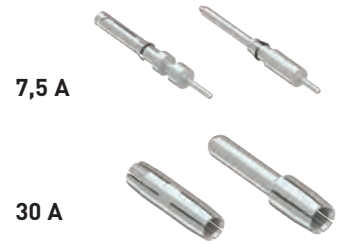
CIF PCB adapters

inserts
CQ 4 poles + 2 poles + ⊕ page: 191

interface
 for printed circuit



7,5 A and 30 A contacts for interface
 silver plated



description	part No.	part No.
-------------	----------	----------

PCB adapter with contacts
 for up to 2,4 mm thick PCB

CIF Q4/2 2.4

7,5 A female contacts for female inserts
 7,5 A male contacts for male inserts

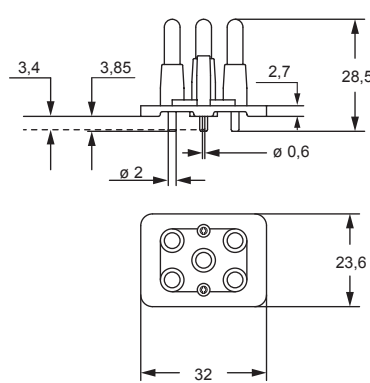
CDFA 6A28
CDMA 6A

silver plated

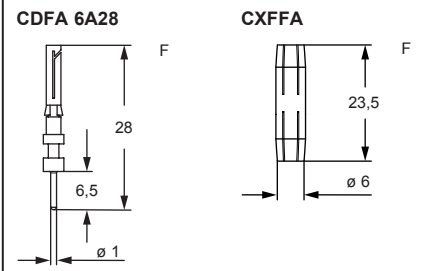
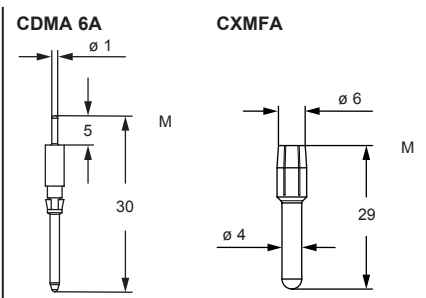
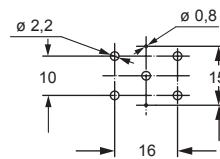
30 A female contacts for female inserts
 30 A male contacts for male inserts

CXFFA
CXMFA

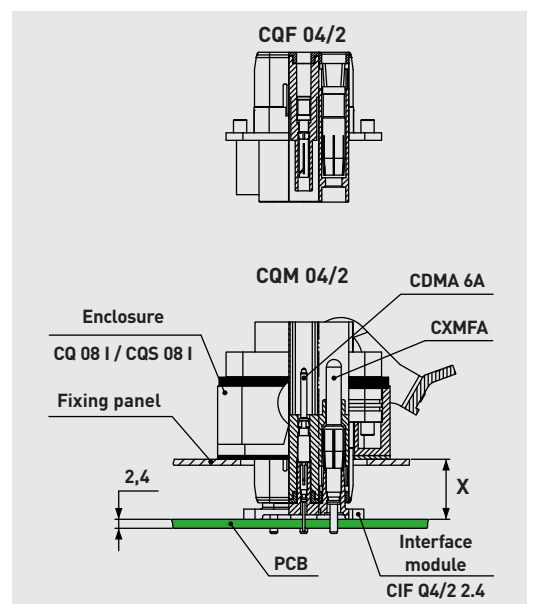
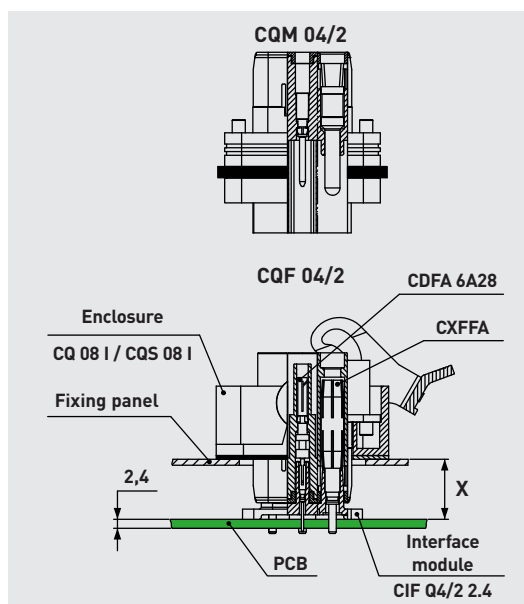
The block is soldered on the printed circuit on which the multipole connector (female or male) equipped with coupling contacts will then be inserted.



PCB-Layout



ASSEMBLY INSTRUCTIONS PCB CIF Q4/2 2.4 ADAPTERS



X = 16⁻¹ WITH SIGNAL CONTACT
 X = 16⁻² WITHOUT SIGNAL CONTACT

CC crimp contacts

inserts		page:
CDC	10, 16 poles + ⊕	104 - 105
CCE	6, 10, 16, 24, 32, 48 poles + ⊕	130 - 135
CMCE	3+2, 6+2, 10+2, 12+4, 20+4 (aux) poles + ⊕	137 - 145
CQE	10, 18, 32, 46, 64, 92 poles + ⊕	168 - 173
CQEE	40, 64 poles + ⊕	176 - 177
CQ	5 poles + ⊕	186
CX	8/24 poles + ⊕	194
CX	6/6 poles + ⊕	206
MIXO (16A)		275 - 289

constantan (Cu Ni) crimp contacts



iron (Fe) crimp contacts



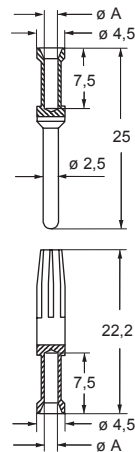
description	part No.	part No.
16A, 0,3 mm ² , AWG 22 female contacts	CCFC 0.3	CCFF 0.3
16A, 0,3 mm ² , AWG 22 male contacts	CCMC 0.3	CCMF 0.3
16A, 0,5 mm ² , AWG 20 female contacts	CCFC 0.5	CCFF 0.5
16A, 0,5 mm ² , AWG 20 male contacts	CCMC 0.5	CCMF 0.5

Note:

A mixed combination of iron, constantan and silver and gold plated contacts can be fitted in the same insert.

- it is recommended to crimp the contacts with crimping tools homologated by ILME (please see the crimping tool section 16A contacts, CCF and CCM on pages 705 - 741)
- for type J (iron - constantan) thermocouples compliant with EN 60584-1
- contact resistance ≤ 1 Ohm

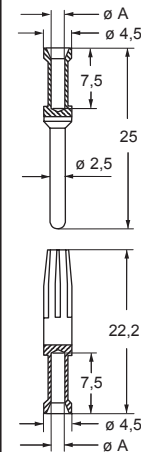
CCF and CCM



CCF and CCM contacts

conductor section mm ²	conductor slot ø A (mm)	conductors stripping length mm
0,3	1,1	7,5
0,5	1,1	7,5

CCF and CCM



CCF and CCM contacts

conductor section mm ²	conductor slot ø A (mm)	conductors stripping length mm
0,3	1,1	7,5
0,5	1,1	7,5

CD crimp contacts 10A

inserts		page:
CD	(10A)	66 - 74
CDD	(10A)	76 - 83
CQ	(10A)	187 - 193
CX 8/24	(16A / 10A)	194
CX 6/36	(10A)	198
CX 12/2	(10A)	199
MIXO	(10A)	271 - 283

10A crimp contacts high thickness gold plated



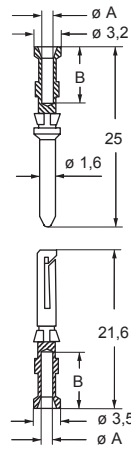
10A crimp contacts basic gold plated



description	part No.	part No.
10A female contacts		
0,14-0,37 mm ² AWG 26-22 identification No. 1	CDF2D 0.3	CDFJD 0.3
0,5 mm ² AWG 20 identification No. 2	CDF2D 0.5	CDFJD 0.5
0,75 mm ² AWG 18 identification No. ②	CDF2D 0.7	CDFJD 0.7
1,0 mm ² AWG 18 identification No. 3	CDF2D 1.0	CDFJD 1.0
1,5 mm ² AWG 16 identification No. 4	CDF2D 1.5	CDFJD 1.5
2,5 mm ² AWG 14 identification No. 5	CDF2D 2.5	CDFJD 2.5
10A male contacts		
0,14-0,37 mm ² AWG 26-22 identification No. 1	CDM2D 0.3	CDMJD 0.3
0,5 mm ² AWG 20 identification No. 2	CDM2D 0.5	CDMJD 0.5
0,75 mm ² AWG 18 identification No. ②	CDM2D 0.7	CDMJD 0.7
1,0 mm ² AWG 18 identification No. 3	CDM2D 1.0	CDMJD 1.0
1,5 mm ² AWG 16 identification No. 4	CDM2D 1.5	CDMJD 1.5
2,5 mm ² AWG 14 identification No. 5	CDM2D 2.5	CDMJD 2.5

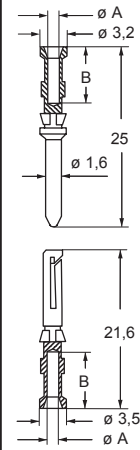
- The gold plated contacts provide:
- corrosion resistance (according to EN 60068)
 - mechanical life: ≥ 500 coupling cycles
 - in compliance with EN 61984:2009, IEC 60512, EN 60352-2: 1994
 - compliant to directive RoHS2
 - contact resistance: ≤ 3 mΩ
 - certifications: (UL for USA and Canada),

CDF2D and CDM2D



contacts CDF2D and CDM2D		
conductor section mm ²	conductor slot ø A (mm)	conductors stripping length B (mm)
0,14-0,37	0,9	8
0,5	1,1	8
0,75	1,3	8
1,0	1,45	8
1,5	1,8	8
2,5	2,2	6

CDFJD and CDMJD



contacts CDFJD and CDMJD		
conductor section mm ²	conductor slot ø A (mm)	conductors stripping length B (mm)
0,14-0,37	0,9	8
0,5	1,1	8
0,75	1,3	8
1,0	1,45	8
1,5	1,8	8
2,5	2,2	6

CC crimp contacts 16A

inserts		page:
CDC	(16A)	104 - 106
CCE	(16A)	130 - 135
CMCE	(16A)	137 - 145
CQE	(16A)	168 - 173
CQEE	(16A)	176 - 177
CX 8/24	(16A / 10A)	194
CX 6/6	(16A / 10A)	206
MIXO	(16A)	275 - 289

16A crimp contacts high thickness gold plated



16A crimp contacts basic gold plated

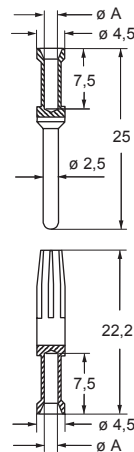


description	part No.	part No.
16A female contacts		
0,14-0,37 mm ² AWG 26-22 one groove	CCF2D 0.3	CCFJD 0.3
0,5 mm ² AWG 20 with no grooves	CCF2D 0.5	CCFJD 0.5
0,75 mm ² AWG 18 one groove (back side)	CCF2D 0.7	CCFJD 0.7
1 mm ² AWG 18 one groove	CCF2D 1.0	CCFJD 1.0
1,5 mm ² AWG 16 two grooves	CCF2D 1.5	CCFJD 1.5
2,5 mm ² AWG 14 three grooves	CCF2D 2.5	CCFJD 2.5
3 mm ² AWG 12 one wide groove	CCF2D 3.0	CCFJD 3.0
4 mm ² AWG 12 with no grooves	CCF2D 4.0	CCFJD 4.0
16A male contacts		
0,14-0,37 mm ² AWG 26-22 one groove	CCM2D 0.3	CCMJD 0.3
0,5 mm ² AWG 20 with no grooves	CCM2D 0.5	CCMJD 0.5
0,75 mm ² AWG 18 one groove (back side)	CCM2D 0.7	CCMJD 0.7
1 mm ² AWG 18 one groove	CCM2D 1.0	CCMJD 1.0
1,5 mm ² AWG 16 two grooves	CCM2D 1.5	CCMJD 1.5
2,5 mm ² AWG 14 three grooves	CCM2D 2.5	CCMJD 2.5
3 mm ² AWG 12 one wide groove	CCM2D 3.0	CCMJD 3.0
4 mm ² AWG 12 with no grooves	CCM2D 4.0	CCMJD 4.0

The gold plated contacts provide:

- corrosion resistance (according to EN 60068)
- mechanical life: ≥ 500 coupling cycles
- in compliance with EN 61984:2009, IEC 60512, EN 60352-2: 1994
- compliant to directive RoHS2
- contact resistance: ≤ 1 mΩ
- certifications: us (UL for USA and Canada),

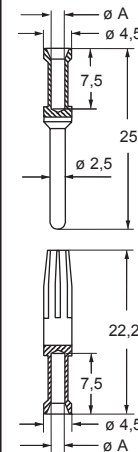
CCF2D and CCM2D



contacts CCF2D and CCM2D

conductor section	conductor slot	conductors stripping length
mm ²	ø A (mm)	mm
0,14-0,37	0,9	7,5
0,5	1,1	7,5
0,75	1,3	7,5
1,0	1,45	7,5
1,5	1,8	7,5
2,5	2,2	7,5
3,0	2,55	7,5
4,0	2,85	7,5

CCFJD and CCMJD



contacts CCFJD and CCMJD

conductor section	conductor slot	conductors stripping length
mm ²	ø A (mm)	mm
0,14-0,37	0,9	7,5
0,5	1,1	7,5
0,75	1,3	7,5
1,0	1,45	7,5
1,5	1,8	7,5
2,5	2,2	7,5
3,0	2,55	7,5
4,0	2,85	7,5

POF contacts series CLF DD and CLM DD

Fibre optic cables provide data transmission not subject to electromagnetic interference, contrary to copper-based (electric) data transmission.

The fibre optic contacts **CL series (CLF DD and CLM DD)** can be used in combination with POF (polymer optical fibre) Ø 1,0 mm (core) / 2,2 mm (sheath) in ILME range of heavy duty multipole connectors, offering the following features:

- inherent immunity to EMI (electromagnetic interference);
- perfect electrical insulation;
- lightweight;
- high transmission capacity and high bandwidth;
- high data security;
- IP66/IP67 recommended to minimize impairing effect of dust contamination;
- male and female contacts CL series for POF Ø 1,0 mm (core) / 2,2 mm (sheath), with same geometry of crimp contacts CD series for conventional copper conductors;
- usable in connector inserts with contact cavities geometry of CDD series, including some modules of MIXO series and some inserts of CQ series, according to **Table 1**.
Not for use in CD inserts series ¹⁾;

Table 1.

CDD series	CDDF/M 24
NOTE – Not suitable for CDDF/M 38 /38 N	CDDF/M 42
	CDDF/M 72, CDDF/M 72 N
	CDDF/M 108, CDDF/M 108 N
CQ series	CQF/M 07
	CQF/M 12
	CQF/M 17
MIXO series modular connectors	CX 12 DF/DM
	CX 17 DF/DM
CX series combined connectors – aux poles number of cavities highlighted in bold	CXF/M 8/ 24
	CXF/M 6/ 36
	CXF/M 12/ 2

¹⁾ For CD inserts series a similar solution for use of POF Ø 1 mm may be developed upon request: please contact our Sales Department or our local Subsidiaries/Distributors.



- use of **alignment/coding pins on connectors/connector modules is mandatory** for fibre optic applications, in order to avoid damages to contacts and in order to minimize the natural attenuation of light signal which is mainly due to inaccuracy of the mating surfaces of the POF (polishing and perfect cleanliness of the two mating fibres) and to axial misalignment;
- POF to be stripped, crimped, cut and polished according to instructions on pages besides.
- for size "77.62" 2-insert combinations use JCHI 32 L/LP (page 120 catalogue XDG JEI 415) or a special version with stainless steel rigid lever available upon request.
- for the installation of fibre optic, **it is recommended to use only bulkhead mounting housings and corresponding hoods with vertical cable outlet.**



Watch
our
online
tutorial

CLF DD / CLM DD

inserts:		page:
CDD	(10A)	76 - 83
CQF/M 07	(10A)	187
CQF/M 12	(10A)	189
CQF/M 17	(10A)	193
CXF/M 8/24	(10A)	194
CXF/M 6/36	(10A)	198
CXF/M 12/2	(10A)	199
MIXO CX 12 DF/DM	(10A)	281
MIXO CX 17 DF/DM	(10A)	282

POF crimp contacts



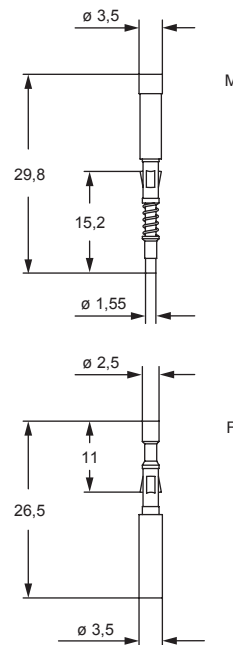
description	part No.
-------------	----------

female contacts for POF *
male contacts for POF *

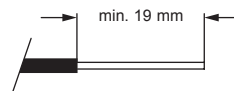
CLF DD
CLM DD

*** POF = Polymer Optical Fibre**

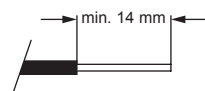
- ambient temperature limit: -40 °C ... +85 °C
- max external diameter: 2,2 mm (POF)
- polymer fibre diameter: 1 mm (POF)
- to crimp contacts CLF DD and CLM DD please use tool CLPZ R
- we recommend use of guide pins CRM/CRF (refer to page 685)



conductor stripping



male contacts



female contacts

CR anchorages

inserts

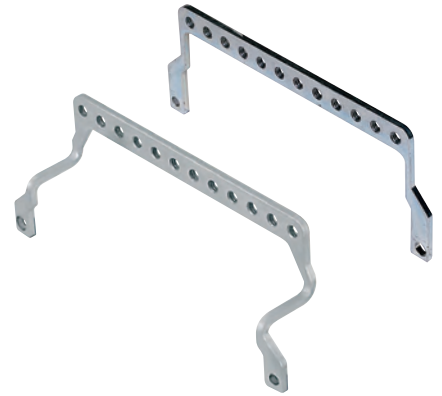
MIXO series

from page 262

shield earthing anchorage for shielded cables
(for MIXO series)
clamps for cables w/shield \varnothing 5 mm and
 \varnothing 10 mm



anchorages for several PE connection
cables (for MIXO series)



description

part No.

part No.

in zinc plated steel, to be mounted on MIXO frames
in bulkhead mounting housings, COB series enclosures
and high construction hoods with top entry
enclosures "44.27" and MIXO frames for 2 modular units
enclosures "57.27" and MIXO frames for 3 modular units *
enclosures "77.27", "77.62" and MIXO frames for 4 modular units
enclosures "104.27", "104.62" and MIXO frames for 6 modular units

CR 06 ST
CR 10 ST
CR 16 ST
CR 24 ST

to be mounted on CR..ST earthing terminals
clamp for shielding cables \varnothing 5 mm
clamp for shielding cables \varnothing 10 mm

CR 05 CA
CR 10 CA

in zinc plated steel, to be mounted on MIXO frames
in bulkhead mounting housings, COB series enclosures
and high construction hoods with top entry
enclosures "44.27" and MIXO frames for 2 modular units
enclosures "57.27" and MIXO frames for 3 modular units
enclosures "77.27", "77.62" and MIXO frames for 4 modular units
enclosures "104.27", "104.62" and MIXO frames for 6 modular units
enclosures "104.27", "104.62" and MIXO frames for 6 modular units

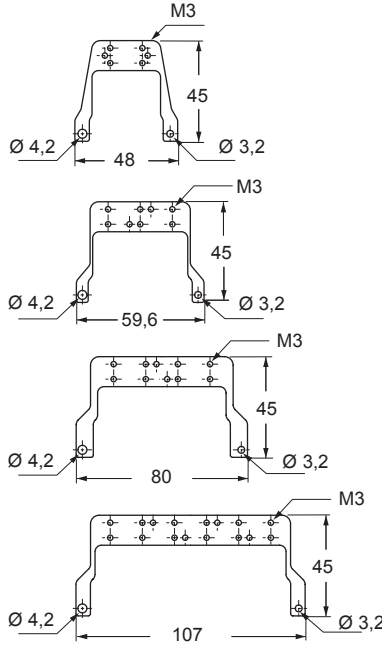
CR 06 AT
CR 10 AT
CR 16 AT
CR 24 AT
CR 24 ATD

* Fixed using the standard screws of the MIXO frame,
the draw size are supplied with a special M4 screw
that replaces the standard one.

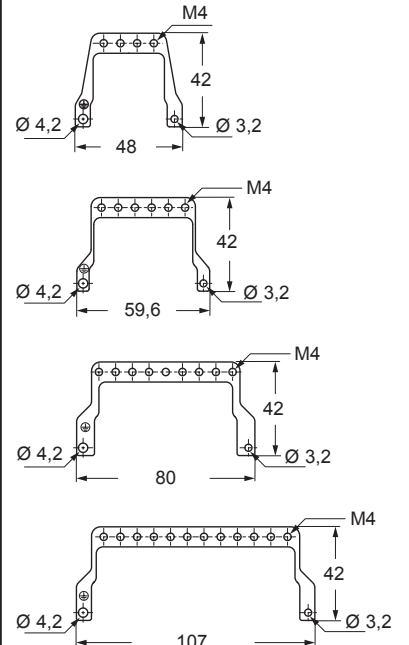
Anchorage CR .. ST are designed for installation
on the frames of the MIXO modular connectors, for earth
connecting the screening braid of shielded cables.

Anchorage CR .. AT / ATD are designed for installation
on the frames of the MIXO modular connectors for earth
connecting several cables.

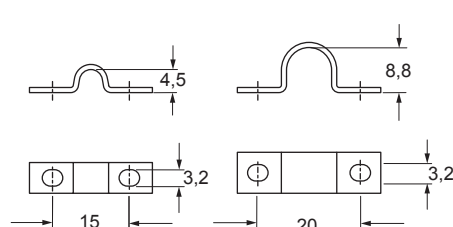
CR...ST



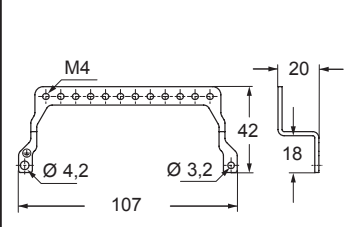
CR...AT



CR...CA



CR 24 ATD



CR anchorages

inserts		page:
CD	40, 64 poles + ⊕	70 and 72
CDD	24, 42, 72, 108 poles + ⊕	76 - 81
CDS	9, 18, 27, 42 poles + ⊕	-
CDSH	9, 18, 27, 42 poles + ⊕	86 - 89
CDSH NC	6 poles + ⊕	95
CNE	6, 10, 16, 24 poles + ⊕	110 - 113
CSE	6, 10, 16, 24 poles + ⊕	-
CSH	6, 10, 16, 24 poles + ⊕	110 - 113
CSH S	6, 10, 16, 24 poles + ⊕	122 - 125
CCE	6, 10, 16, 24 poles + ⊕	130 - 133
CMSH	3+2, 6+2, 10+2 (aux) poles + ⊕	136 - 140
CSS	6, 10, 16, 24 poles + ⊕	148 - 151
CQE	10, 18, 32, 46 poles + ⊕	168 - 171
CQEE	40, 64 poles + ⊕	176 - 177
CP	6 poles + ⊕	178
CX	8/24, 6/36, 12/2 poles + ⊕	194 - 199

ground terminals for shielded cables and for several earth connections



clamps for cables Ø 5 mm and Ø 10 mm



description	part No.	part No.
-------------	----------	----------

in zinc plated iron, to be fitted on connectors in bulkhead housings, COB series enclosures and high construction hoods with top entry
 "44.27" enclosures and inserts
 "57.27" enclosures and inserts
 "77.27", "77.62" enclosures and inserts
 "104.27", "104.62" enclosures and inserts
 CSS "104.27" enclosures and inserts *

CR 06 SC
CR 10 SC
CR 16 SC
CR 24 SC
CR 24 SCA

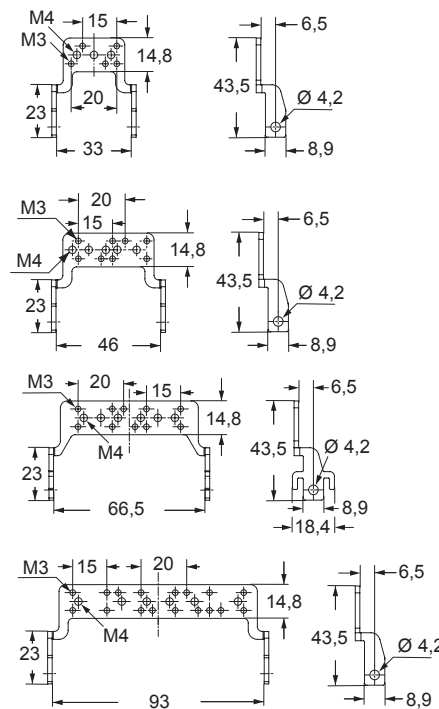
to be fitted on CR..SC anchors
 in bulkhead mounting housings and high construction hoods
 U-bolt for Ø 5 mm cable screening
 U bolt for Ø 10 mm cable screening

CR 05 CA
CR 10 CA

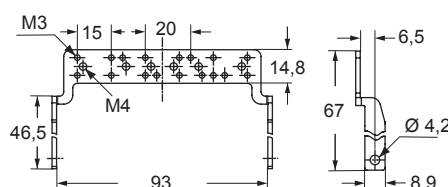
* Can be used only in bulkhead housings.

The CR... SC anchors are fitted on connectors for connecting to earth multiple cables and screened cables braids.

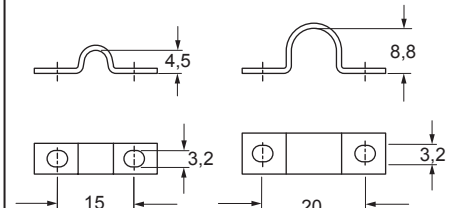
CR...SC



CR...SCA



CR...CA



CR anchorages

The CR..FS series anchorages are employed for use of connector inserts (normal or MIXO modular) without enclosures and enable anchoring cables with clamps to prevent transmitting traction forces to contacts. CR..SS anchorages (with grip to facilitate connector disconnection) are used for earth connecting of several conductors and/or of the screen of shielded cables.

cable anchorages shield / earthing strain relief



supports, screws and clamps for grip panels of cables outside enclosure



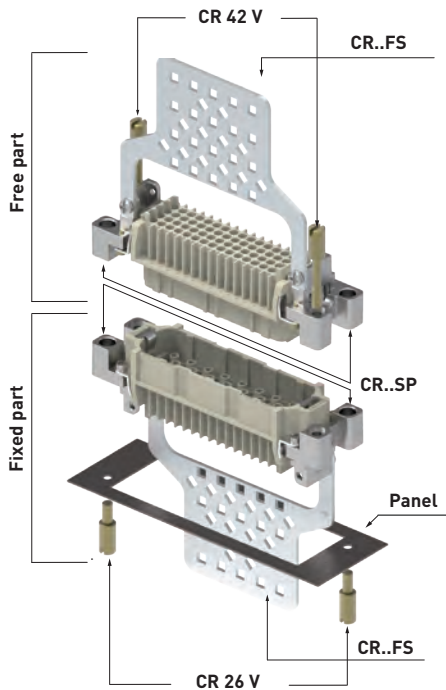
description	part No.	part No.
in zinc plated steel, to be mounted on: inserts size "44.27" * and MIXO frames for 2 modular units inserts size "57.27" * and MIXO frames for 3 modular units inserts size "77.27" * and MIXO frames for 4 modular units inserts size "104.27" * and MIXO frames for 6 modular units	CR 06 FS CR 10 FS CR 16 FS CR 24 FS	
for shielded cables with grip handle, to be mounted on: inserts size "77.27" * and MIXO frames for 4 modular units inserts size "104.27" * and MIXO frames for 6 modular units	CR 16 SS CR 24 SS	
supports in die-cast zinc, 2 pcs. equipped with fixing screws and washers for earth connection		CR SP
short screws in zinc iron, 2 pcs. long screws in zinc iron, 2 pcs.		CR 26 V CR 42 V
to be mounted on CR..SS anchorage clamp for shielding cables Ø 5 mm clamp for shielding cables Ø 10 mm		CR 05 CA CR 10 CA

* Except CT, CTS and CTSE

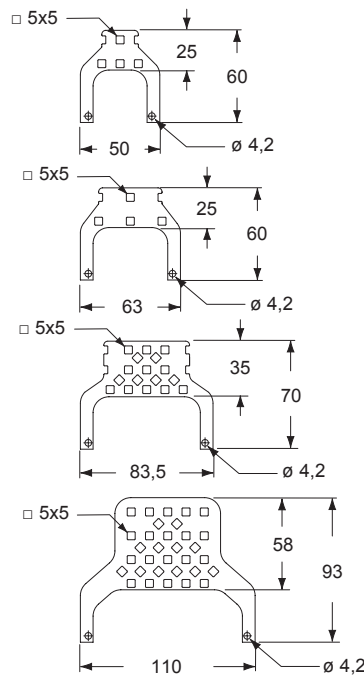
In the fixed part, a pair of **CR SP** supports is fitted on the connector, using its securing screws. A **CR..FS** or **CR..SS** anchorage is fitted on the supports, using the supplied fixing screws and washers. All parts are secured on the rear panel with the pair of **CR 26 V** short + + screws.

In the mobile part too, a pair of **CR SP** supports are fitted on the connector and a **CR..FS** or **CR..SS** anchorage is secured on it. The pair of **CR 42 V** screws fasten the mobile part to the fixed part.

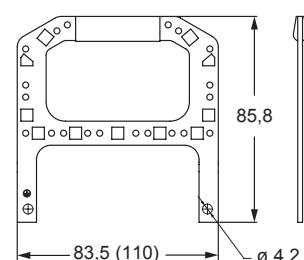
NOTE: By unscrewing the **CR 26 V** special short screws, the whole assembly (free part + fixed part) can be removed from the panel for inspection.



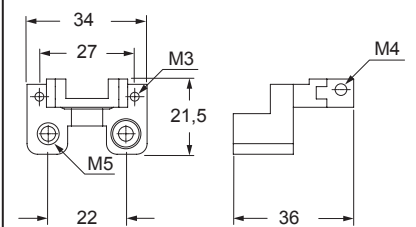
CR..FS



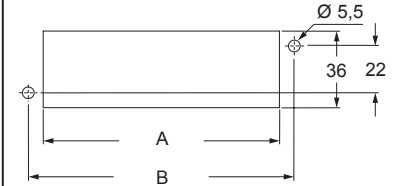
CR 16 SS (CR 24 SS)



CR SP

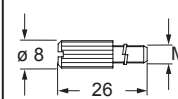


panel cut-out

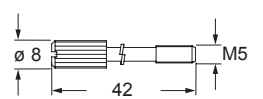


poles	06	10	16	24
A	52	65	85,5	112
B	65	78	98,5	125

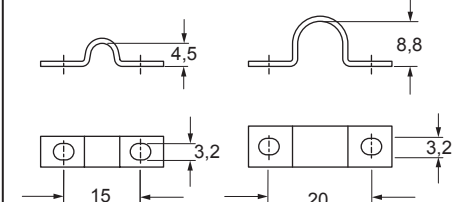
CR 26 V



CR 42 V

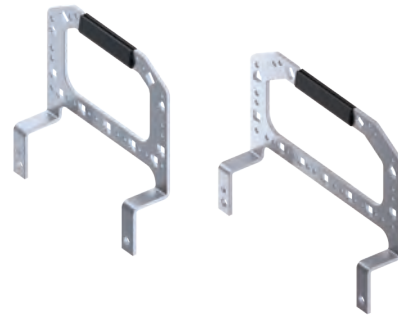


CR..CA



CR anchorages

anchorage for cables outside enclosure, equipped with fixing screws and washers



supports, screws and clamps for grip panels of cables outside enclosure



description	part No.	part No.
-------------	----------	----------

for cables, to be mounted on:
 inserts size "77.27" * with CR SP support
 and MIXO frames for 4 inserts without support
 inserts size "104.27" * with CR SP support
 and MIXO frames for 6 inserts without support

CR 16 SSD
CR 24 SSD

support in die-cast zinc, 2 pcs. equipped with fixing screws and rings for earth connecting

CR SP
CR 26 V
CR 42 V

short screws in zinc plated steel, 2 pcs.
 long screws in zinc plated steel, 2 pcs.

to be mounted on CR..SS anchorage
 clamp for (shielded) cables \varnothing 5 mm
 clamp for (shielded) cables \varnothing 10 mm

CR 05 CA
CR 10 CA

* Except CT, CTS and CTSE

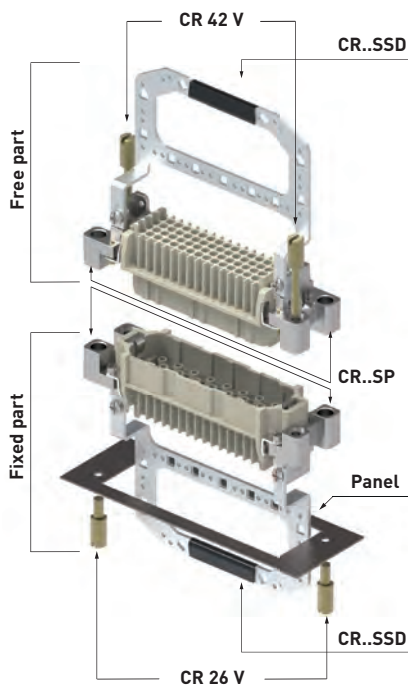
In the fixed part, a pair of **CR SP** supports is fitted on the connector insert, using the insert's fixing screws.

A **CR..SSD** anchorage is then fitted on the **CR SP** supports, using the supplied fixing screws and washers.

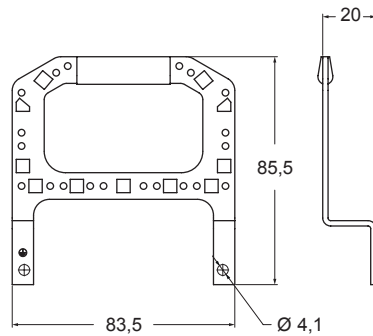
All parts are secured on the rear panel with a pair of **CR 26 V** special short screws.

Also in the free part, a pair of **CR SP** supports is fitted on the connector insert and a **CR..SSD** anchorage is similarly secured on it. A pair of **CR 42 V** long screws fasten the free part to the fixed part.

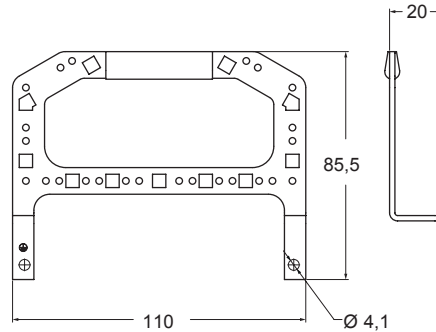
NOTE: By unscrewing the **CR 26 V** special short screws, the whole assembly (free part + fixed part) can be removed from the panel for inspection.



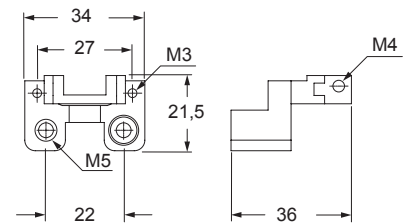
CR 16 SSD



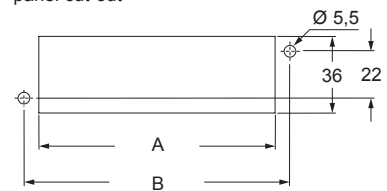
CR 24 SSD



CR SP

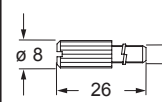


panel cut-out

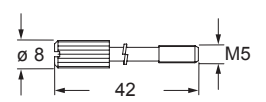


poles	06	10	16	24
A	52	65	85,5	112
B	65	78	98,5	125

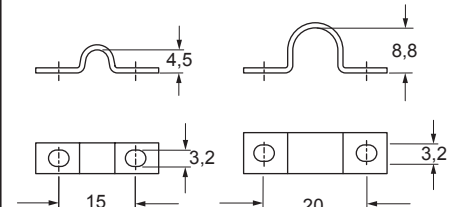
CR 26 V



CR 42 V



CR..CA



CR...DF self-centring floating frame

Q CAUTION: As the frames are floating, the **PE earthing connection of the metal surfaces on which they are mounted** (mounting bases) **must be performed separately** and cannot be done by connecting the PE earthing contact to the corresponding connector inserts.

NOTE: The supply includes 1 frame and 4 shoulder screws with cylindrical head and notch to fix the frame in place.

For use with MIXO inserts CX 04 X, please contact ILME S.p.A.

self-centring floating frame



description

part No.

in stainless steel, to be mounted on:
 inserts size "44.27" * and MIXO frames for 2 modular units
 inserts size "57.27" * and MIXO frames for 3 modular units
 inserts size "77.27" * and MIXO frames for 4 modular units
 inserts size "104.27" * and MIXO frames for 6 modular units

CR 06 DF
CR 10 DF
CR 16 DF
CR 24 DF

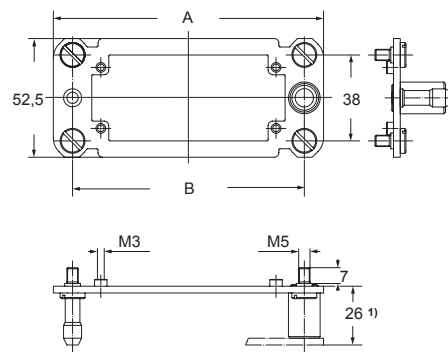
* Except CT, CTS and CTSE

Technical specifications

- materials
 - floating frame, inserts: stainless steel
 - fixing screws: zinc-plated steel
- mechanical endurance: ≥ 500 cycles
- compensation range:
 - x axis: $\pm 1,5$ mm
 - y axis: $\pm 1,5$ mm

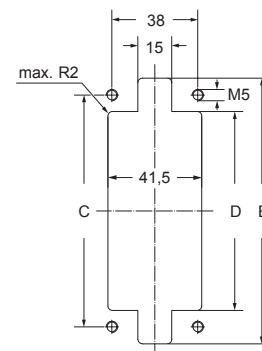
Characteristics

- Suitable, depending on size, for all standard and MIXO connector inserts and frames, except series CT, CTS and CTSE.
- Designed to be used in the transportation, printing and power electronic industries (for example boxes for rack cabinets) and in all industrial applications that require, during assembly or maintenance, the connection of connectors without possibility of controlling the alignment.
- Enables the **self-centring coupling of two corresponding** connectors without the use of enclosures; they freely move on their base plate ($\pm 1,5$ mm on both axes) ensuring the **alignment of the coupling**.

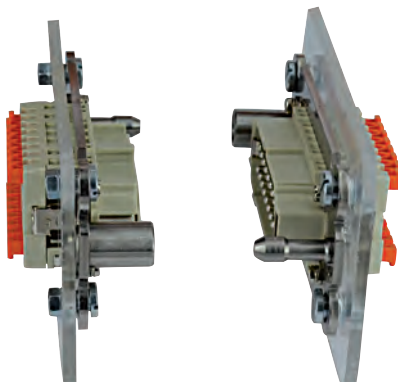


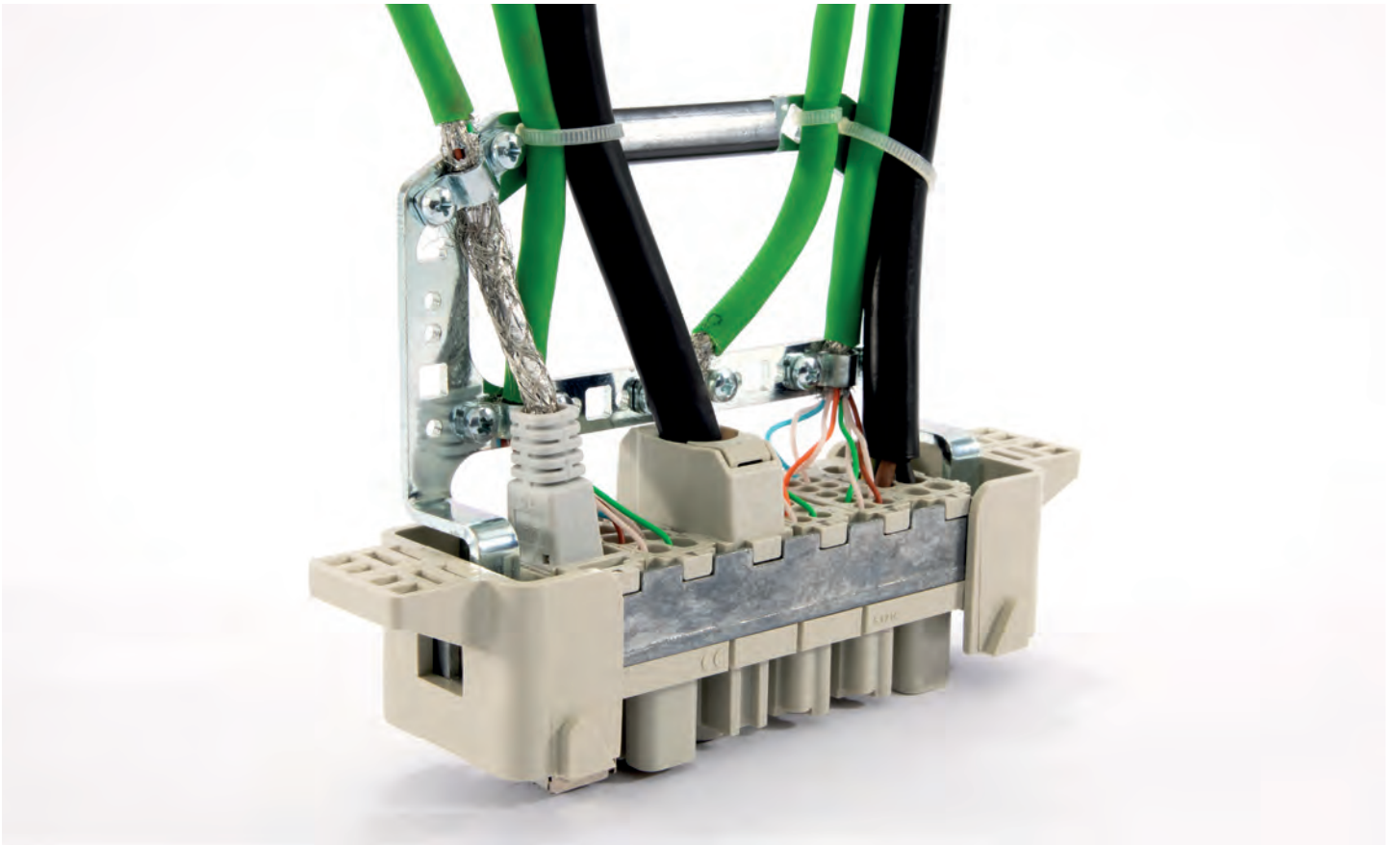
1) distance for electric and fibre optic contacts:
 max 27 mm
 distance for pneumatic contacts:
 max 26,5 mm

panel cut-out



part No.	A	B	C	D	E
CR 06 DF	86	69	69	54,5	84
CR 10 DF	99	82	82	67,5	97
CR 16 DF	119,5	102,5	102,5	88	117,5
CR 24 DF	146	129	129	114,5	144



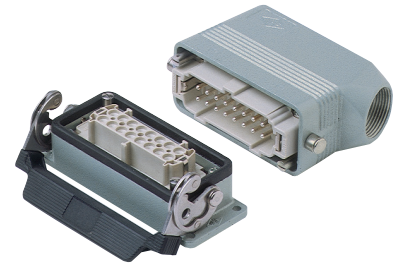


CR coding pins

single coding pin for 6 codings



coding options using single coding pins



description	part No.	part No
single coding pin (not for MIXO inserts)	stainless steel CR 20	zinc plated steel CR 20 D
single coding pin (for MIXO inserts only)	stainless steel CR 20 CX	zinc plated steel CR 20 CX D

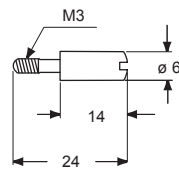
CR 20/CR 20 D and CR 20 CX/CR 20 CX D coding pins

Each series of connector inserts is made in such a way as to make incorrect coupling between inserts of different series impossible.

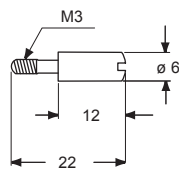
When a number of identical connectors with different functions are mounted closely together these must be selected in such a way as to prevent the coupling of a mobile part on a non-corresponding fixed part and consequent damage and breakdown.

Coding pins are supplied to apply in place of the normal insert fastening screws (see example below). In this way the coupling of identical connectors is assured. The combination of coding pins makes it possible to obtain a high number of selective couplings.

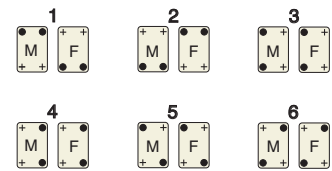
CR 20 / CR 20 D



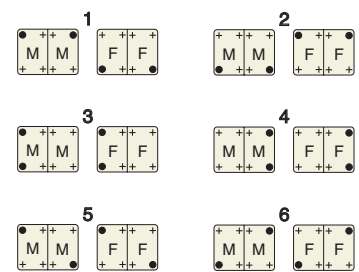
CR 20 CX / CR 20 CX D



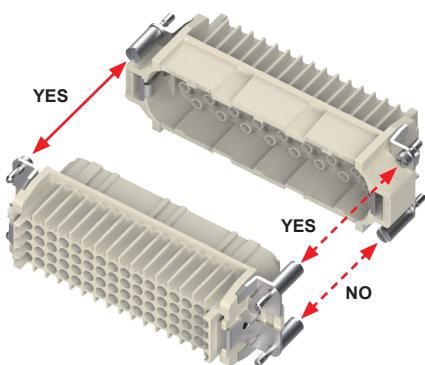
Application with single insert



Application with double inserts



- coding pin
(CR 20/CR 20 D and CR 20 CX/CR 20 CX D)
- + normal fixing screw
- M = male insert
- F = female insert



CR coding pins

double coding and guiding pins for 16 codings



available coding options by using double coding and guiding pins



description	part No.	part No
double coding and guiding pins (excluding MIXO inserts) male pin	stainless steel CRM	zinc plated steel CRM D
female pin	CRF	CRF D
double coding and guiding pins (for MIXO inserts only) male pin	stainless steel CRM CX	zinc plated steel CRM CX D
female pin	CRF CX	CRF CX D

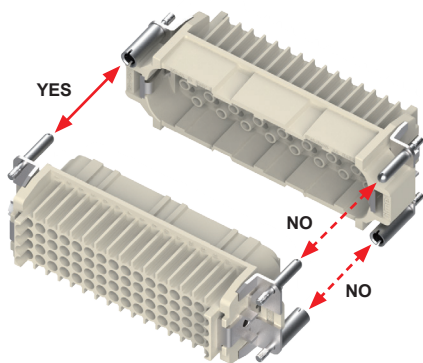
Coding pins

- CRM/CRM D and CRF/CRF D
- CRM CX/CRM CX D and CRF CX/CRF CX D

Each series of connector inserts is made in such a way as to make incorrect coupling between inserts of different series impossible.

When a number of identical connectors with different functions are mounted closely together these must be selected in such a way as to prevent the coupling of a mobile part on a non-corresponding fixed part and consequent damage and breakdown.

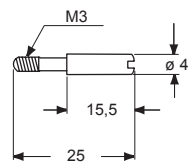
Coding pins are supplied to be applied in place of the normal insert fastening screws (see example below). In this way the coupling of identical connectors is assured. The combination of coding pins makes it possible to obtain a high number of selective couplings.



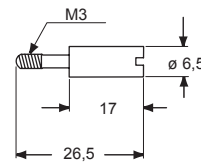
Even when coding is not required, it is recommended to use CRM and CRF pins with CD and CDD inserts to reduce movements when fitting and removing the connectors and to avoid contact damages.

Within this scope, the EN 175301-801 standard (former DIN 43 652) requires a maximum angular fluctuation of $\pm 5^\circ$ on the long side, $\pm 2^\circ$ on the short side.

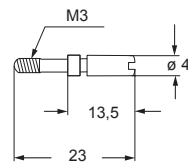
CRM / CRM D



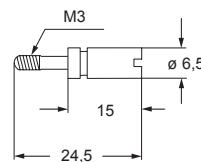
CRF / CRF D



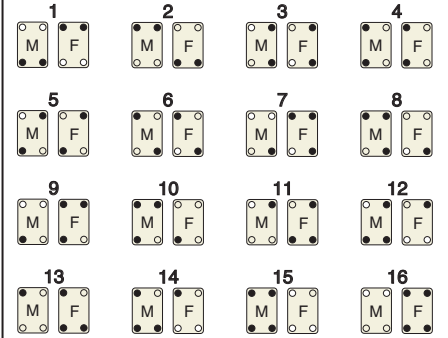
CRM CX / CRM CX D



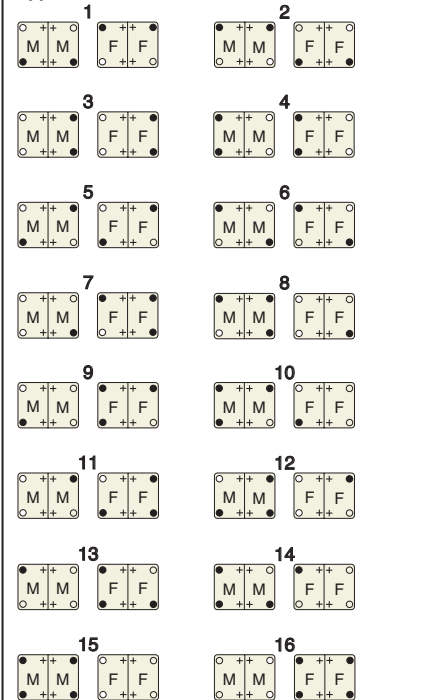
CRF CX / CRF CX D



Application with single insert



Application with double inserts



- female coding and guiding pins (CRF/CRF D and CRF CX/CRF CX D)
- male coding and guiding pins (CRM/CRM D and CRM CX/CRM CX D)
- + normal fixing screw
- M = male insert
- F = female insert

CR coding pins

coding and guiding pins, for 72 codings



description	part No.	part No
double coding and guiding pins (excluding MIXO inserts) male pin female pin single code pin	stainless steel CRM CRF CR 72	zinc plated steel CRM D CRF D CR 72 D
double coding and guiding pins (for MIXO inserts only) male pin female pin single code pin	stainless steel CRM CX CRF CX CR 72 CX	zinc plated steel CRM CX D CRF CX D CR 72 CX D

Coding pins

- CRM/CRM D, CRF/CRF D and CR 72/CR 72 D
- CRM CX/CRM CX D, CRF CX/CRF CX D and CR 72 CX/CR 72 CX D

Each series of connector inserts is made in such a way as to make incorrect coupling between inserts of different series impossible.

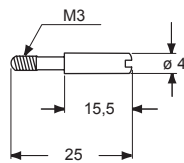
When a number of identical connectors with different functions are mounted closely together these must be selected in such a way as to prevent the coupling of a mobile part on a non-corresponding fixed part and consequent damage and breakdown.

Coding pins are supplied to be applied in place of the normal insert fastening screws.

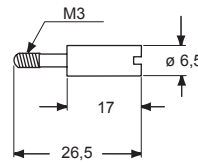
In this way the coupling of identical connectors is assured.

The combination of coding pins makes it possible to obtain a high number of selective couplings.

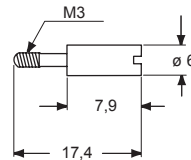
CRM / CRM D



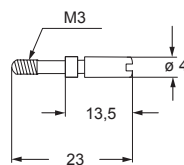
CRF / CRF D



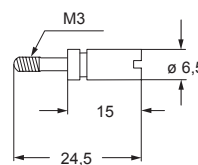
CR 72 / CR 72 D



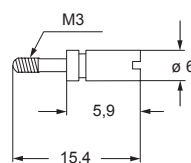
CRM CX / CRM CX D



CRF CX / CRF CX D



CR 72 CX / CR 72 CX D



Coding options using the three coding and guiding pins



- female coding and guiding pin (CRF/CRF D and CRF CX/CRF CX D)
- male coding and guiding pin (CRM/CRM D and CRM CX/CRM CX D)
- single coding pin (CR 72/CR 72 D and CR 72 CX/CR 72 CX D)
- M** = male insert
- F** = female insert

CR coding pins

coding pin
for CK / CKSH 03 inserts

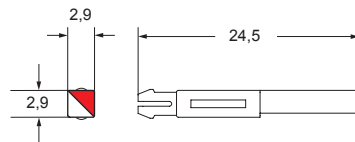


coding pins
for CK / CKSH 04 inserts

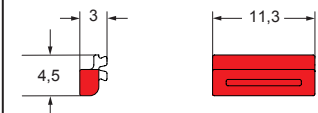


description	part No.	part No.	part No.
coding pin for CK/CKSH 03 inserts	CR K03		
coding pins for CK/CKSH 04 inserts		red CR K04R	yellow CR K04G

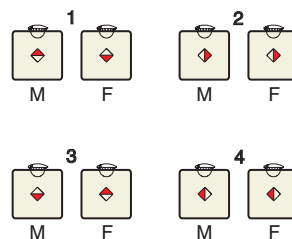
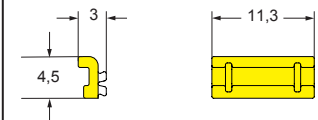
CR K03



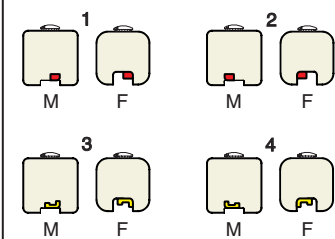
CR K04R



CR K04G



M = male insert
F = female insert



M = male insert
F = female insert

With coding pin
CR K03



CR coding pins

coding pins for crimp inserts



coding pin for CQ 12 inserts



description	part No.	part No.
-------------	----------	----------

coding pin for CDC, CQ 05, CQ 08, CQE, CCE, CMCE, MIXO (16A) inserts
pin to be inserted into one contact cavity of the female insert instead of the crimp contact, the corresponding contact cavity of the male insert must be left empty

CR CPQ

coding pin for CD and CDD inserts
plastic pin, to be inserted into one contact cavity of the female insert instead of a crimp contact, the corresponding contact cavity of the male insert must be left empty

CR CP

coding pin for CQ 12 inserts

CR Q12

Coding pins

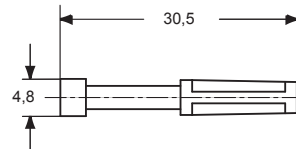
Each series of connector inserts is made in such a way as to make incorrect coupling between inserts of different series impossible.

When a number of identical connectors with different functions are mounted closely together these must be selected in such a way as to prevent the coupling of a mobile part on a non-corresponding fixed part and consequent damage and breakdown.

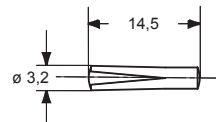
Within this scope, special coding pins have been manufactured in order to restrict or avoid mating identical multiple connectors.

By combining multiple coding pins, a high number of selected matings can be produced.

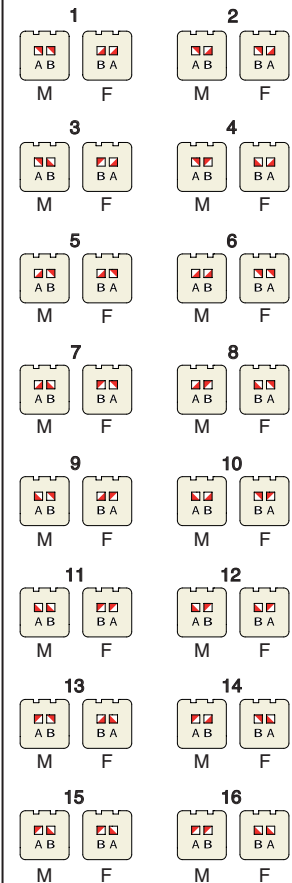
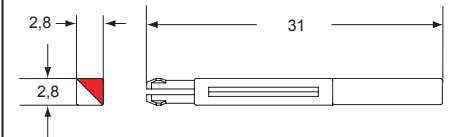
CR CPQ



CR CP

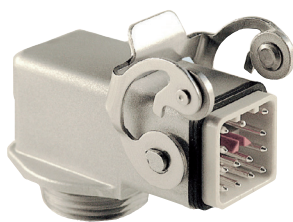


CR Q12



[A B] CQ 12 coding pin M = male insert
F = female insert

With coding pins CR Q12



With coding pin CR CP



CR coding pins

coding pin
for CQF 07 insert



coding pin
for CQM 07 insert

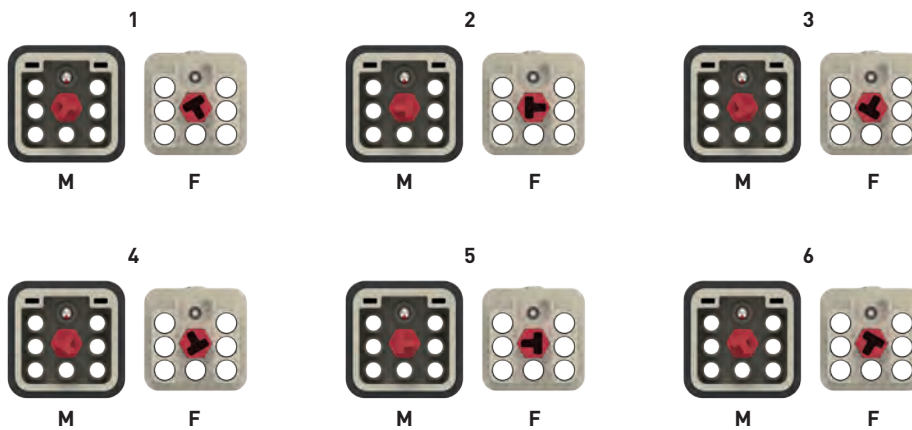
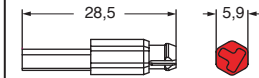
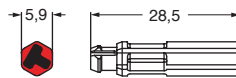


description	part No.	part No.
coding pin for CQF 07 insert	CR QF07	
coding pin for CQM 07 insert		CR QM07

Coding pins

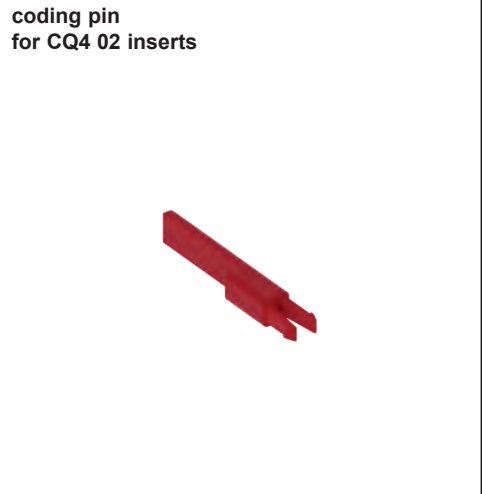
Each series of connector inserts is made in such a way as to make incorrect coupling between inserts of different series impossible. When a number of identical connectors with different functions are mounted closely together these must be selected in such a way as to prevent the coupling of a free part on a non-corresponding fixed part and possible consequent damage and breakdown.

Within this scope, special coding pins have been made available in order to restrict or avoid incorrect mating between multiple identical connectors.



M = male insert
F = female insert

CR coding pins

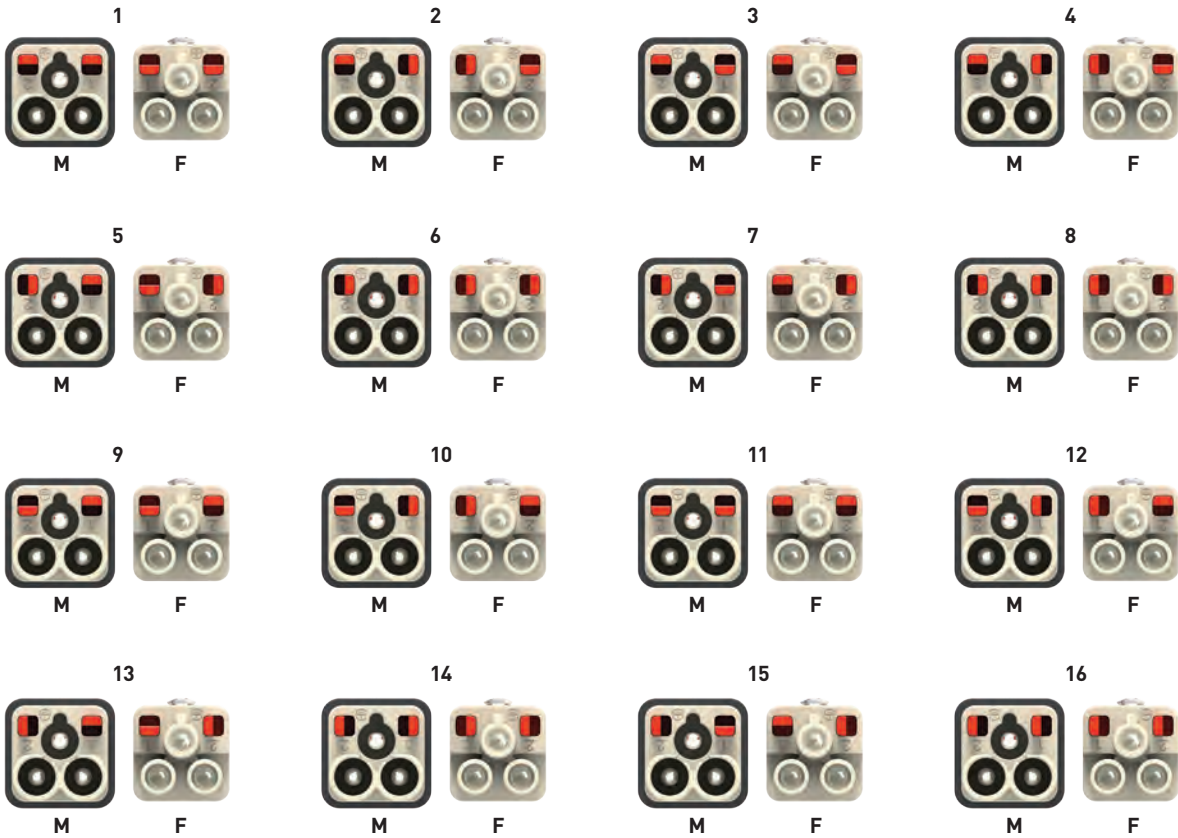
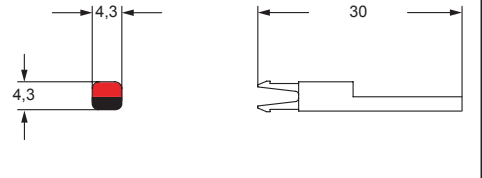


description	part No.
-------------	----------

coding pin for CQ4 02 inserts

CR Q02

It is possible to achieve up to **16 different codings** thanks to the use of **two optional CR Q02 coding pins: 4 coding pins for each connector coupling**. It is possible to install two pins with 4 positions each.



CR Q02 coding pins

M = male insert
F = female insert

ACCESSORIES

CR coding pins

coding pin
for CQAM 12 T1 and CQ4F/M 03

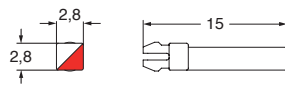


description

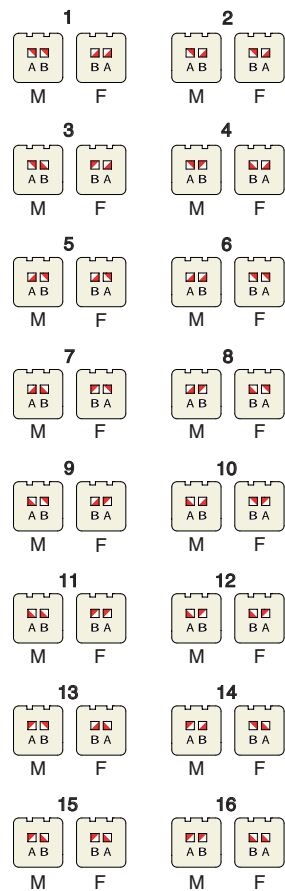
part No.

coding pin for CQAM 12 T1 termination connectors
and for CQ4F/M 03 connectors

CR Q03



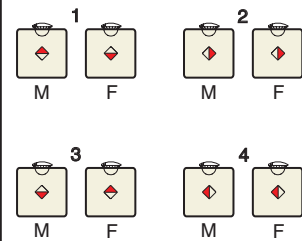
for CQAM 12 T1 (2 pins)



 (A B) CQ 12 coding pin

M = male insert
F = female insert

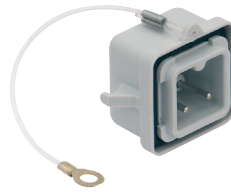
for CQ4F/M 03 (1 pin)



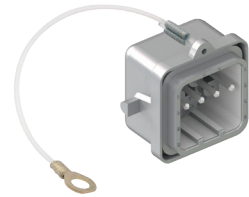
M = male insert
F = female insert

CKM - CQAM termination connectors

termination connector
for CKF/CKSF/CKSHF 03 inserts



termination connector
for CQF 12 insert



description	part No.	part No.
with pegs and seal, connects pole 2 with pole 3	CKM 03 T1	
with pegs and seal, connects pole 1 with pole 2	CKM 03 T3	
with pegs and seal, connects pole 5 with pole 6 and pole 7 with pole 8		CQAM 12 T1

CKM 03 T1 - CKM 03 T3

- characteristics according to EN 61984:

10A 400V 4kV 3

- cULus (UL for USA and Canada), DNV-GL BUREAU VERITAS

ERC certified

When the termination connector is mated with a CKF/CKSF/CKSHF 03 insert (complete with an enclosure with lever), it performs a dual function:

- connects two socket insert poles
- acts as a cover (IP65 protection rating compliant with EN 60529 standard, with lever closed).

CQAM 12 T1

- characteristics according to EN 61984:

10A 400V 6kV 3

10A 400/690V 6kV 2

- cULus (UL for USA and Canada), DNV-GL BUREAU VERITAS

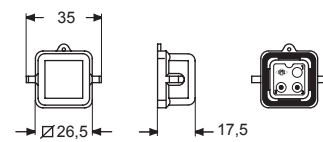
ERC certified

When the terminal connector is mated with a CQF 12 insert (complete with an enclosure with lever), it performs a dual function:

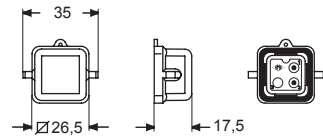
- connects two socket insert poles
- acts as a cover (IP65 protection rating compliant with EN 60529 standard, with lever closed).

CR Q03 coding pins can be used with CQAM 12 T1, in this case the CQF 12 inserts must be provided by CR Q12.

CKM 03 T1

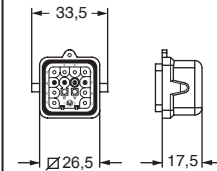


CKM 03 T3



- interconnected male contacts

CQAM 12 T1



- interconnected male contacts

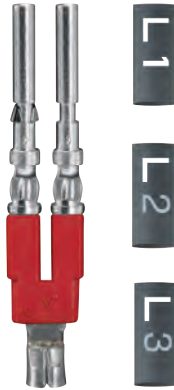
CR bridges for delta connection

inserts

CQF *	12 poles + ⊕
CDDF	24, 42, 72 (144), 108 (216) poles + ⊕
CX 17 DF (MIXO)	1 module

* for enclosures C-TYPE series (CKA/MKA ..I/VS) only

bridges for delta connection



description

part No.

bridge with 2 female 10A contacts, silver plated and open type crimp barrel

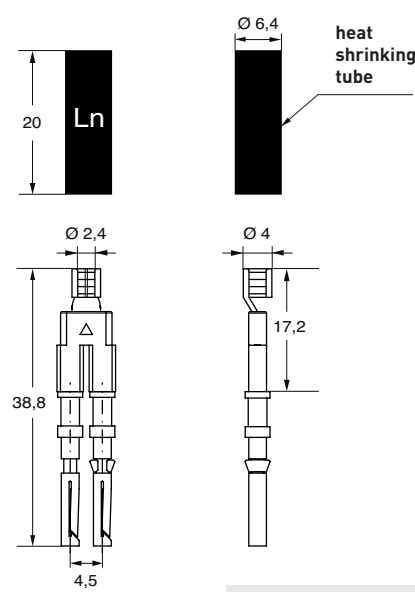
CR BDE

NOTE:

The typical use of the product requires three bridges each with its shrinking tube with L1 / L2 / L3 marking to identify the phases in the wiring.



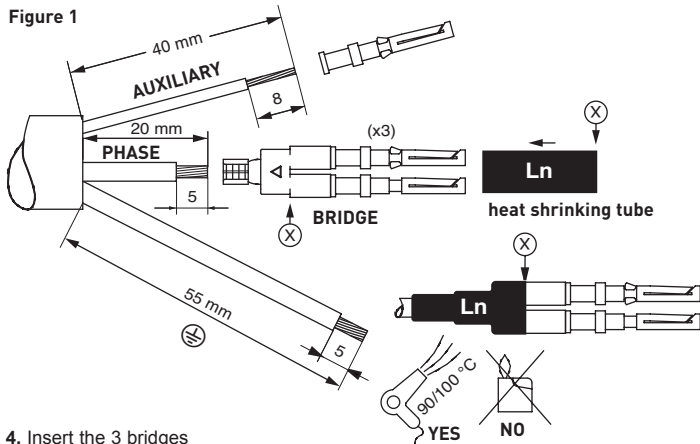
1. Cut and strip the wires as shown in Figure 1.
2. Crimp the contacts on the auxiliary wires and the bridge end to the phase wires (3 units) using CRPZ pliers and CRD matrix (position 2,5).
3. Insert the insulating heat shrinking tubes on the bridges, their end must be aligned with the position ⊗. Then heat them at 90/100 °C till they shrink over the wires.



For wires with cross-section ranging from 1,5 to 2,5 mm² (16-14 AWG), crimp connection with CRPZ pliers (model CEMBRE IDT) and CRD matrix.

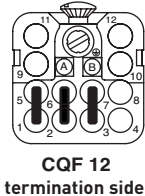


Figure 1

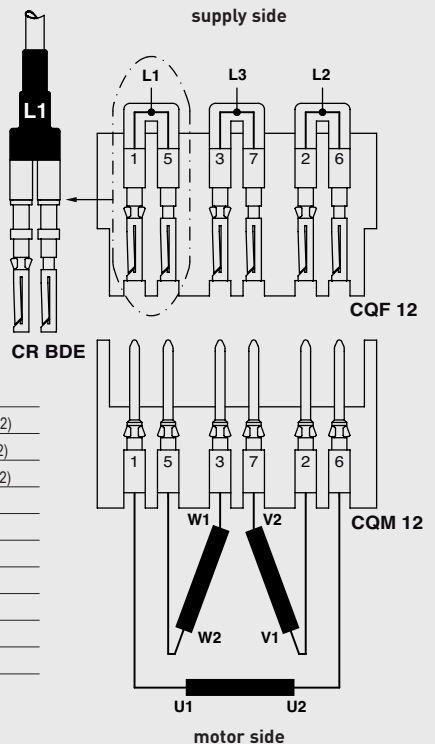


4. Insert the 3 bridges according to the Figure 2.

Figure 2



Example of DELTA connection using inserts CQ 12



1-5	BRIDGE L1 (winding U1/W2)
2-6	BRIDGE L2 (winding V1/U2)
3-7	BRIDGE L3 (winding W1/V2)
4	auxiliary circuit
8	auxiliary circuit
9	auxiliary circuit
10	auxiliary circuit
11	auxiliary circuit
12	auxiliary circuit
⊕	protective earth

CR bridges for star connection

inserts

CQF		12 poles + ⊕
CDDF	24, 42, 72 (144), 108 (216) poles + ⊕	
CX 17 DF (MIXO)		1 module

bridges for star connection

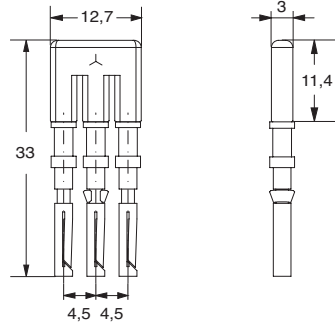
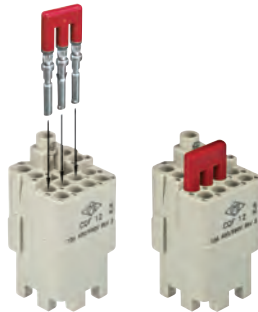


description

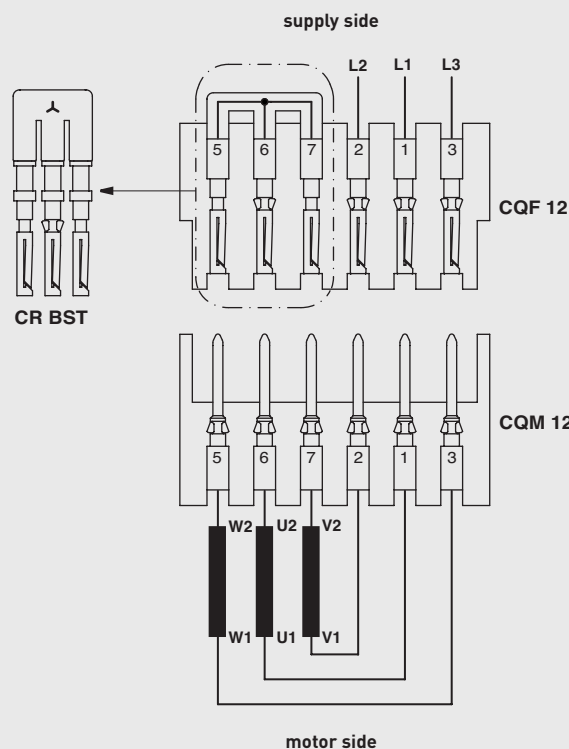
part No.

bridge with 3 female 10A contacts, silver plated

CR BST



Example of STAR connection using inserts CQ 12



5-6-7	BRIDGE W2-U2-V2
1	L1
2	L2
3	L3
4	auxiliary circuit
8	auxiliary circuit
9	auxiliary circuit
10	auxiliary circuit
11	auxiliary circuit
12	auxiliary circuit
⊕	protective earth

CHCP protection cover

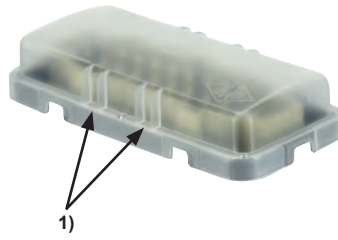
enclosures

size "44.27", "57.27", "77.27", "104.27"

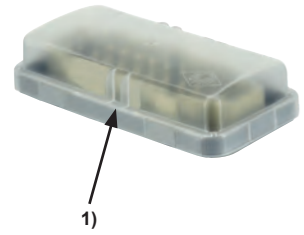
for versions:

- C-TYPE IP65/IP66
- C7 IP67 stainless steel lever
- V-TYPE IP65/IP66 stainless steel lever
- BIG hoods
- W-TYPE for aggressive environments
- EMC
- 180 °C
- central lever
- LS-TYPE

dust protection cover



painting protection cover 2)



description

part No.

part No.

for housings and hoods with 1 or 2 levers, with 2 or 4 pegs
 size "44.27"
 size "57.27"
 size "77.27"
 size "104.27"

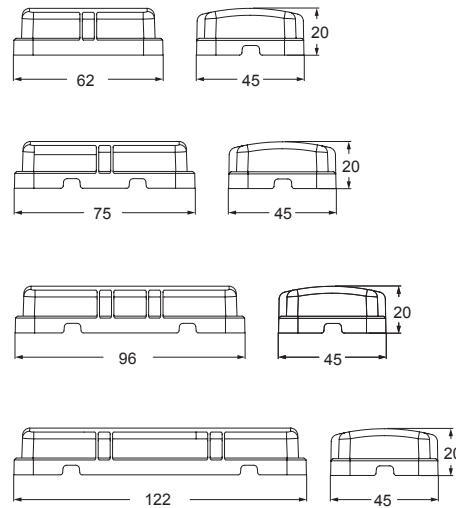
CHCP 06
CHCP 10
CHCP 16
CHCP 24

CHCP 10 V

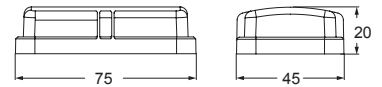
1) Possibility of using cable ties to increase the retention of the insulating cover on the hood.

2) For housings and hoods with gasket only.

CHCP



CHCP 10 V



CGKCP - CGCP protection cover

for versions:

- IP68

size "21.21", "44.27", "57.27", "77.27", "104.27"

dust protection cover,
for housings



dust protection cover,
for hoods



description	part No.	part No.
-------------	----------	----------

for housings and hoods

size "21.21"

size "44.27"

size "57.27"

size "77.27"

size "104.27"

CGKCP FX
CGCP 06 FX
CGCP 10 FX
CGCP 16 FX
CGCP 24 FX

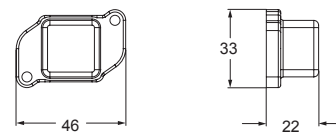
CGKCP MB
CGCP 06 MB
CGCP 10 MB
CGCP 16 MB
CGCP 24 MB

1) Possibility of using cable ties to increase the retention of the insulating cover on the hood.

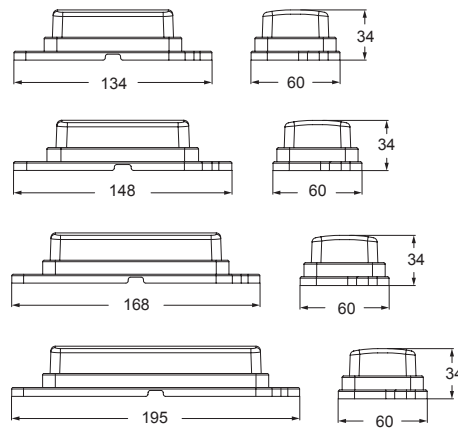
2) Possibility to fix by screw:

- CGKCP FX: 2xM3
- CGCP FX: 2xM6

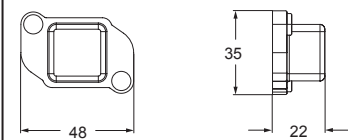
CGKCP FX



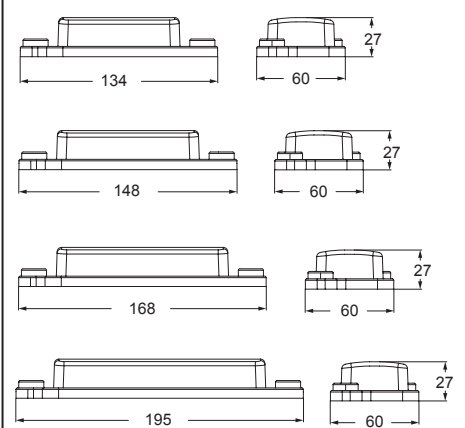
CGCP FX



CGKCP MB



CGCP MB

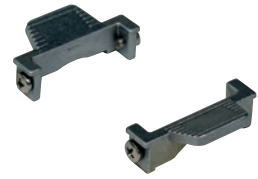


CBGF CR TM-1

insert joining block



metal replacement handles



description

part No.

part No.

made of die cast aluminium alloy
to mate two inserts (see below)
to replace thermoplastic handles
2 component kit for dual lever enclosures ¹⁾

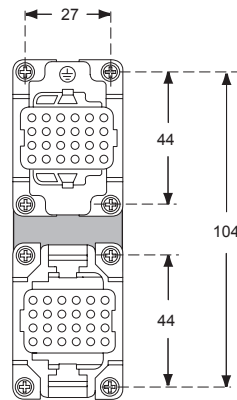
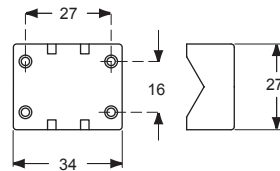
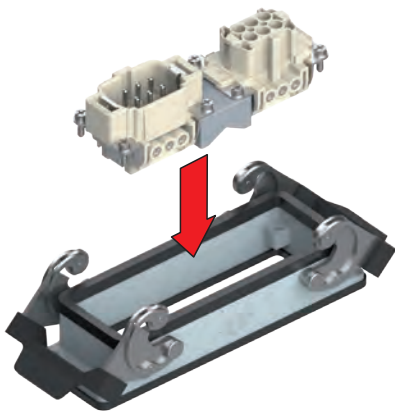
CBGF

CR TM-1

¹⁾ can only be used on dual lever enclosures sizes 57.27, 77.27 and 104.27

CBGF combination block

- Allows two "44.27 size" inserts to be inserted in "104.27 size" enclosures and on the following COB series items: COB TCQ, COB 24 BC, COB TSF, COB TSFS, COB 24 CMS
- Allows female inserts and male inserts in the same enclosure or mounting
- Allows mixed type inserts in the same enclosure or mounting (for example, 6 poles 16A CNEF + 24 poles 10A CDDF)



C-TYPE enclosures (with two levers only):

- size "57.27" from page 393
- size "77.27" from page 402
- size "104.27" from page 412

NOTE

Inserts shown in the drawing are just an example; any "44.27" sized inserts may be combined in a "104.27" housing, including of different gender.

C-TYPE enclosures:

size "104.27" from page 412

panel supports:

COB page 652 - 653

CPT - CPES

inserts
size "104.27"

from page 412

temporary protection cover
for transportation



pliers for uncoupling connectors



description	part No.	part No.
-------------	----------	----------

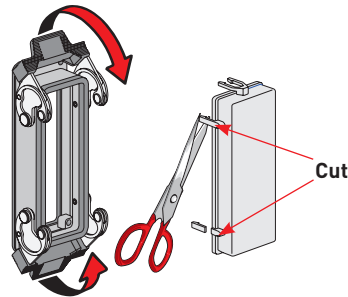
for housings and hoods
with 1 or 2 levers, with 2 or 4 pegs ¹⁾
for housings and hoods
with 2 levers and 4 pegs

CPT 24

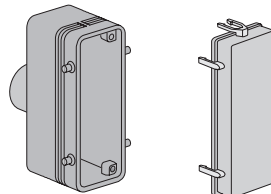
CPES

¹⁾ Cannot be used with T-TYPE series

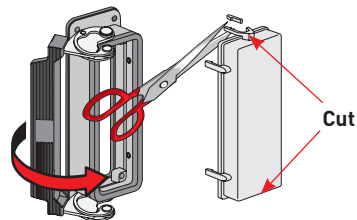
CPT 24 for enclosures with 2 levers



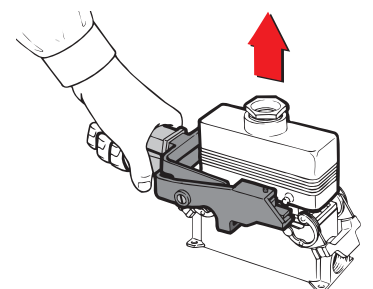
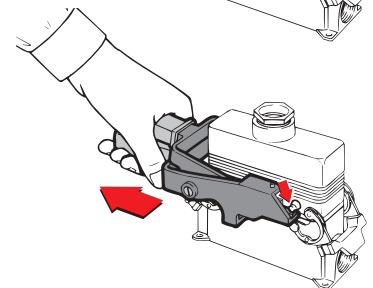
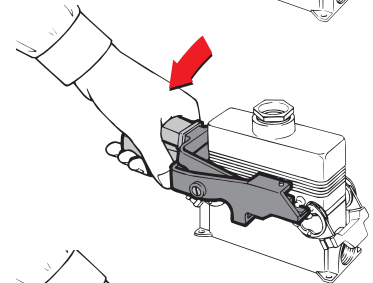
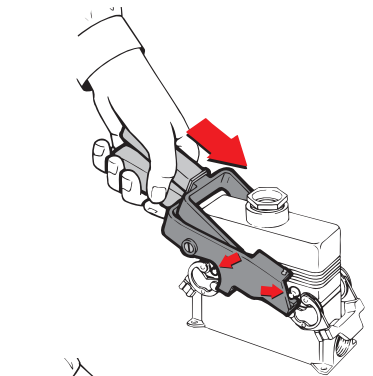
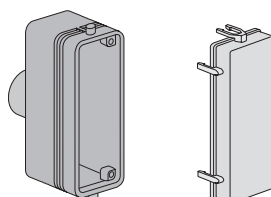
CPT 24 for enclosures with 4 pegs



CPT 24 for enclosures with 1 lever



CPT 24 for enclosures with 2 pegs



CR..AD - CR..AD1 - CR..AD2 plates

enclosures

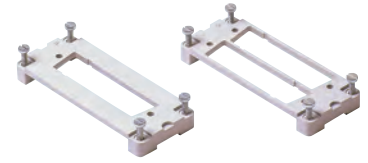
- size "49.16" from page 374
- size "66.16" from page 378
- size "44.27" from page 387
- size "57.27" from page 393
- size "77.27" from page 402

Use M3 passing screws tightened with nut and washer (not included).
Verify connection continuity of coupled connectors

adapter plates for D-Sub inserts (IEC 60807-2)
CZ / MZ / MZF enclosures



adapter plates for D-Sub inserts (IEC 60807-2)
CH / CA and MH / MA / MF enclosures



description	part No.	for enclosures size	part No.	for enclosures size
for 1 D-Sub insert 9 poles (not included)	CR 09 AD	"49.16"	CR 09 AD1	"44.27"
for 1 D-Sub insert 15 poles (not included)	CR 15 AD	"49.16"	CR 15 AD1	"44.27"
for 1 D-Sub insert 25 poles (not included)	CR 25 AD	"49.16"	CR 25 AD1	"57.27"
for 1 D-Sub insert 37 poles (not included)	CR 37 AD	"66.16"	CR 37 AD1	"77.27"
for 1 D-Sub insert 50 poles (not included)	CR 50 AD	"66.16"	CR 50 AD1	"77.27"
for 2 D-Sub inserts 9 poles (not included)			CR 09 AD2	"44.27"
for 2 D-Sub inserts 15 poles (not included)			CR 15 AD2	"44.27"
for 2 D-Sub inserts 25 poles (not included)			CR 25 AD2	"57.27"
for 2 D-Sub inserts 37 poles (not included)			CR 37 AD2	"77.27"
for 2 D-Sub inserts 50 poles (not included)			CR 50 AD2	"77.27"

Plates CR...AD, CR...AD1 and CR...AD2

For machinery or command equipment that need connection with programming and control electronic devices. The plate housings have notches for the rear insertion of cabled D-Sub inserts.

CR...AD

mounting on bulkhead housings and hoods
one-way mounting in bulkhead housings or hoods.

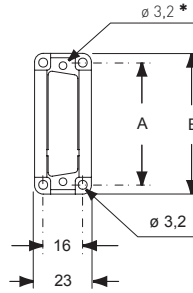
CR...AD1 and CR...AD2
mounting on bulkhead housings (Figure 1)

The D-Sub connector must be mounted on the side marked with the letter "A"

Mounting on hoods (Figure 2)

The D-Sub connector must be mounted on the side marked with the letter "T"

CR...AD



* For pass-through screws type M3

The electrical continuity is guaranteed only if mounted in our enclosures.

part No.	A	B
CR 09 AD	49,5	56,5
CR 15 AD	49,5	56,5
CR 25 AD	49,5	56,5
CR 37 AD	66	73,5
CR 50 AD	66	73,5

CR...AD1

Figure 1

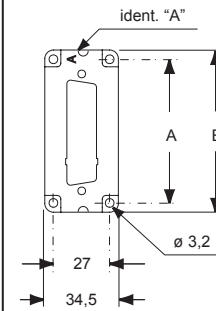
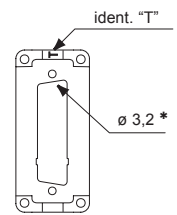


Figure 2



* For pass-through screws type M3

CR...AD2

Figure 1

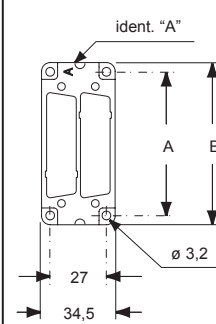
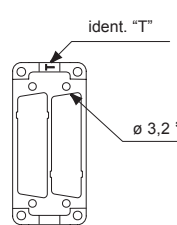
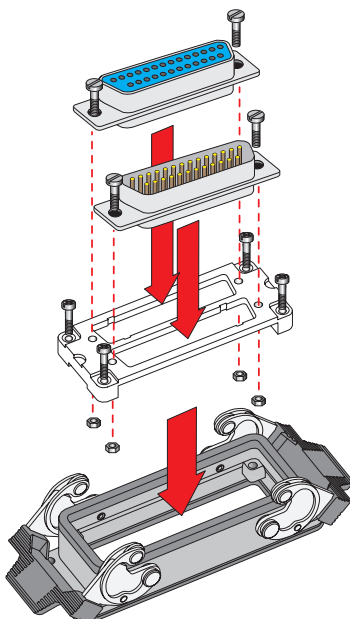


Figure 2



* For pass-through screws type M3

part No.	A	B
CR 09 AD1 / 2	44	51,5
CR 15 AD1 / 2	44	51,5
CR 25 AD1 / 2	57	64,5
CR 37 AD1 / 2	77,5	85
CR 50 AD1 / 2	77,5	85



SDS - CHSDS kit for control equipment

enclosures *)
 size "104.62"
 C-TYPE IP65/IP66
 *) normally bulkhead type

page:
 430
 kit for control equipment
 plate only



kit for control equipment
 plate with enclosure



description	part No.	for enclosures	part No.
-------------	----------	----------------	----------

with Schuko® socket 16A and 2 seats for:
 CR 09 AD, CR 15 AD, CR 25 AD plates
 with Schuko® socket 16A and 2 seats for:
 CR 09 AD, CR 15 AD, CR 25 AD plates

SDS

CHI 48 LS

CHSDS

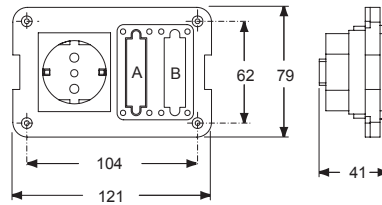
Kit for control equipment

For machinery or command equipment that need connection with programming and control electronic devices.

The kit includes the Schuko® socket and 2 seats for the CR...AD plates (not included) for D-sub inserts (not included).

Personal computers, notebooks or printers can be power supplied using a 16A socket.

Monitors, printers and other peripheral devices may be interfaced using D-sub connectors

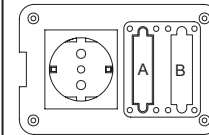
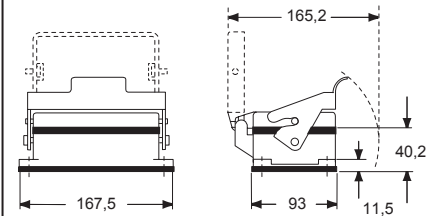


Closed seat "A" for use with one insert only. The closing is achieved by means of a plastic membrane that can easily be removed if the second seat is required.

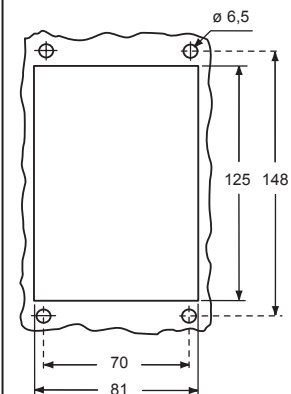
CR.. AD plates to be ordered separately.

CR...AD usable plates

part No.	
CR 09 AD	for 1 D-sub insert 9 poles (not included)
CR 15 AD	for 1 D-sub insert 15 poles (not included)
CR 25 AD	for 1 D-sub insert 25 poles (not included)



housing panel cut-out



CRH - CRZ closure and reduction plate

enclosures

- size "44.27"
- size "57.27"
- size "77.27"
- size "104.27"

- from page 387
- from page 393
- from page 402
- from page 412

"104.27" closure plate



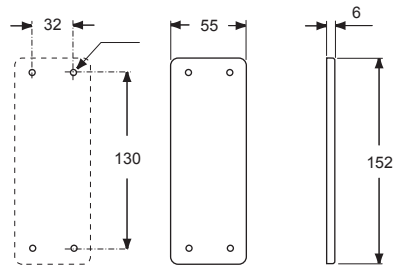
reduction plate



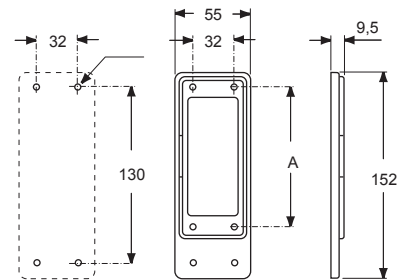
description	part No.	part No.
in self-extinguishing thermoplastic resin with gasket in vinyl-nitrile elastomer	CRH 24	
in self-extinguishing thermoplastic resin with gasket in vinyl-nitrile elastomer for bulkhead mounting housings ¹⁾ size "44.27"		CRZ 06
for bulkhead mounting housings ¹⁾ size "57.27"		CRZ 10
for bulkhead mounting housings ¹⁾ size "77.27"		CRZ 16
for bulkhead mounting housings ¹⁾ size "104.27"		CRZ 24

¹⁾ Cannot be used with T-TYPE series and IP68 CG/MG series

CRH 24



CRZ



CRZ	A
06	44
10	44
16	57
24	77,5

CX BES extraction tool

extraction tool for MIXO BUS connectors



description	part No.
-------------	----------

tool for the extraction of the shielded connectors (coax **CX 01 BF/M** page 291, **CX 01 BCF/M** page 289, **CX 04 BF/M** page 291, **CX 08 BF/M** page 293) from either the **CX 1/2 BDF/M** adapters (page 243) or the MIXO BUS **CX 02 BF/M** (page 290) modular units.

CX BES

The crimping concept

The crimp connection is an irreversible, non-reusable connection between one or two conductors and a crimp contact. It is obtained by compression deformation (cold forming) and consequent reshaping of the contact crimping stem, or crimp barrel. A good crimp connection is provided by a suitable combination between the crimping dies, the contact crimp barrel (hence the crimp contact), and the cross-section of the conductor.

These considerations refer to crimped connections made with flexible copper conductors of class 5 (flexible) or 6 (more flexible than class 5) according to EN IEC 60228 standard.

Solid copper conductors (class 1) or conductors made by other materials (aluminium, iron, etc.) often require special precautions for both crimp contacts and crimping tools, to be agreed upon with the manufacturer.

The main technical advantages provided by crimped connections over soldered connections are:

- Independence from temperature, being this a “cold” process, performed without using heat and not requiring further materials.
- Elimination of the contact uncertainties due to cold solders.
- No degradation of the elastic characteristics of the female contacts (a problem that arises with soldering temperatures).
- No health risks connected with the use of heavy metals or fumes generated from the soldering process.
- Preservation of the conductor's flexibility immediately beyond connection.
- No conductors with burned, discoloured or overheated insulating material.
- Excellent reproducibility of the performances of the electrical and mechanical connections.
- Easier production controls.

Other advantages obtained by crimping connections over screw-type connections are:

- Lower voltage drop across the connection.
- High stability in time even in the presence of vibrations.
- High durability in presence of corrosion (gas-tightness).
- Individual insertion of the contacts in the connector (it is possible to eliminate unnecessary contacts).
- Less time required for connection.
- Possibility of pre-production of the terminated conductors with crimp contacts.
- Easy replacement of individual contacts during maintenance.
- Possibility of selectively isolating the circuits during maintenance via the extraction of the contacts from the connector.

The crimped connections for wire sections up to 10 mm² are covered by the EN 60352-2:2006 European standard equivalent to the IEC 60352-2 Issue 2 (2006-02) international standard.

The **EN 60352-2** standard also includes a practical guidance, which lists the following main points.

The quality of a crimped connection is mainly affected by the quality of the materials used and by the condition of the surfaces both of the crimp contact (in particular the crimp barrel) and of the conductor.

To ensure a good quality crimped connection, an essential parameter is the mechanical retention of the conductor in the contact. The standard makes a distinction between the closed crimp barrel, inherently stronger, and the open crimp barrel. ILME crimp contacts are closed crimp barrel contacts, with inspection hole which ensure a higher mechanical performance compared to the open barrel crimp contacts, such as better mechanical robustness and stability during operation. They have been high speed precision-machined, thus ensuring a better electrical performance (better conductivity).

In 2002 the Amendment 2 of the previous IEC standard had controversially unified the minimum tensile strength for open crimp barrel contacts (curve B of former Figure 5) and closed crimp barrel contacts (curve A of former Figure 5) making them both equal to the lower values (those of curve B), which can be achieved by open barrel crimp contacts. This change has determined an arguable relaxation of the suitability requirements both for closed crimp barrel, typically larger, machine turned and for crimp tools specially made for these contacts. Several industries continue to prefer the higher performance ensured by closed crimp barrel contacts, the only ones able to ensure the higher resistance to tensile stress values believed to be essential for the most demanding industrial applications.

Therefore, ILME continues to refer to curve A of Figure 5 illustrated in the EN 60352-2:1994 standard: ILME closed crimp barrel contacts, used with flexible copper wires, featuring a cross-sectional area included in the ranges shown and correctly crimped with the recommended tools, ensure tensile breaking resistant connections at least equal to the values shown in the table below (for reference, the corresponding $R_{\sqrt{S}}$ unified tensile stress load value is also shown [N/mm²]). See Table 1.

Section S		Resistance to traction R_t (N)	R_t/S (N/mm ²)
AWG	mm ²		
26	0,12	18	150
-	0,14	21	150
24	0,22	33	150
-	0,25	37,5	150
22	0,32	48	150
-	0,37	55,5	150
20	(0,6)	75	150
-	0,75	112,5	150
18	(0,82)	125	150
-	1	150	150
16	(1,3)	195	150
-	1,5	220	147
14	(2,1)	300	143
-	2,5	325	130
12	(3,3)	430	130
-	4	500	125
10	(5,3)	635	120
-	6	650	108
7	10	1000	100
		(1300)	(130)
-	16	1650	103
-	25	2300	92
-	35	2800	80
	50	3300	66
-	70	3900	56

Table 1.

NOTE - For 10 mm² wire sections, the resistance to tensile stress shown in *italics* are those specified in the NF F 61-030 standard (for 10 mm², the value in brackets).

The basic criterion used for the tensile strength values required by EN 60352-2 standard is that such resistance is at least equal to 60% of the per unit breaking load of the same annealed copper conductor.

This applies to conductor cross-sectional areas up to about 1,5 mm²; above this cross-section, the ratio is slightly lower, as retention is also affected by friction, which increases linearly with the housing diameter, whilst the cross-section increases by the square.

IEC/EN 60352-2 standard, which historically targeted the electronics industry, restricts its requirements to crimp connections for conductors with a maximum cross-sectional area of 10 mm². For cross-sections higher than 10 mm², up to 70 mm², the standard to refer to is the NF F 61-030:1989 French standard which relates to electrical connectors to be used on board of railway rolling stock, in particular for large crimp contacts, such as those manufactured by ILME.

NOTE - Alternatively, for wire sections between 35 mm² and 300 mm², EN 61238-1:2003 standard can be referred to.

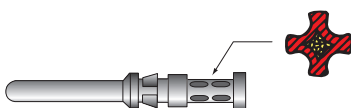
This standard requires constant R_t/S values equal to 60 N/mm², lower than those established by the above mentioned French standard.

Selecting the crimping tool and relevant controls

When you have selected quality crimp contacts and conductors, the next and most important step is to select the correct crimp tool. The practical guidance of standard EN 60352-2 provides the following recommendations on the subject, listing some of the ideal requirements for crimping tools, some optional characteristics, but, above all, it provides a preview of the indispensable controls:

- a) The crimping tools and the contacts used shall be supplied by the same manufacturer, otherwise the user shall assume all responsibility for the quality and reliability of the crimp connections.
- b) The crimping tools must function correctly and provide a correct crimp without damage to the pin or the component to crimp.
- c) In order to obtain a reliable crimp connection, a crimping device with a mechanism that controls the entire crimping cycle shall be used. At the end of the crimping cycle the handles and the ratchet must return to the open position.
- d) In all cases the crimping operation shall be made in one single phase, with no further interventions.
- e) The removable parts of the tool such as the crimping dies and the locators must be designed in such a way as to make it possible to be inserted within the tool only in the correct manner.
- f) The tools must be supplied with the appropriate means for a correct positioning of the pins to be crimped and of the conductors during crimping.
- g) The tools must be designed in such a way so that only the necessary adjustments may be made.
- h) The action of the tool must be such that both the pin to be crimped and the fixture of the isolation (when present) are respectively crimped or compressed with a single action.
- i) The design of the tool must ensure that the dies for a particular tool may be interchangeable within tools of the same type. If they are not interchangeable, the identification of tools for which they are suitable must be marked on the dies.
- j) The tools may be designed so as to produce a marking or coding of the die on the pin to be crimped so that the crimping may be checked for verification of the correct die.
- k) The design of the tool must allow the verification of the dies with gauges to measure wear. The gauge verification method must be that specified by the manufacturer of the tools.

With suitable flexible copper conductors, the crimping tool proposed by ILME gives 8-indent crimping (see figure) in conformity with standard EN 60352-2. Periodic control of the wear of the crimping dies can be carried out with the appropriate "go – no go" gauges (to be purchased separately). For extra operational details, consult the following pages on tools, and the relevant instruction sheets and/or use and maintenance manuals.



The manual and automatic crimping tools selected by ILME are carefully designed to ensure symmetrical deformation of the crimping area of the contact and wire, by means of their own, internal high pressure forming parts. The positioner ensures that the wire and crimp contact meet in the appropriate part of the tool. Sprung mechanisms built into the tools ensure that the contacts are not inserted in the tool before the indenters are fully open, and that the tool does not open before the crimping process has been completed.

The **CIPZ D** (for 5A crimp contacts), **CCPZ MIL** (for 10A and 16A crimp contacts) and **CXPZ D** (for 40A crimp contacts) manual crimping tools are suitable for use when compressed air sources are unavailable, for low or medium-low workloads.

The **CCPZ RN** (for 10A, 16A and 40A crimp contacts) manual crimping tool is also suitable for low or medium-low workloads.

All the above tools provide 8-indent crimping.

The **CCPZ TP** (for 10A and 16A crimp contacts) and **CXPZ TP** (for 40A crimp contacts) manual crimping tools are also suitable for low or medium-low workloads and provide a "square shaped" crimping cross-section. Crimped connections produced by these tools are in compliance with the requirements of EN 60352-2.

The **CCPZP** pneumatic crimping bench tool without automatic positioner (for 10A and 16A crimp contacts) is suitable for use in the workshop (where compressed air is available) for high or medium-high workloads. Using the same manual crimping tool turrets, it is possible to change rapidly from crimping on male contacts to crimping on female contacts of the same series (10A and 16A).

The **CCPZPA** pneumatic crimping bench tool with automatic positioner (for 10A and 16A crimp contacts) is suitable for workshop jobs (where compressed air is available) for medium-high or high workloads. It is recommended in particular for crimping high quantities of contacts that are the same type or have the same section, thus saving a significant amount of time thanks to automatic operation and reduced operator fatigue. Where the type or kind of contact must be changed frequently, it is preferred to use the version without automatic positioner.

The **CXPZP D** pneumatic crimping bench tool without automatic positioner (for 40A crimp contacts) is suitable for use in the workshop (where compressed air is available) for high or medium-high workloads. By using the same positioners as those of manual crimper CXPZ D, the size of a contact can be rapidly changed with one of the same type.

The semiautomatic stripping-crimping machine, type **ZFU-CD**, is suitable to be used in workshops (where an electrical or pneumatic power supply is available) and for heavy workloads. It enables to produce large amounts of crimped connections in less time because of the possibility of simultaneously carrying out stripping and crimping operations. The contact and tool replacement operations, which are minimized because of the pre-set programs that can be stored and customized by the user, require the production to be programmed to reduce downtime. When a sequential processing is required despite the economic advantages offered by the above-described solution, it is preferable to use pneumatic bench pliers without the above-described positioner or one of the manual pliers.

In any case, the quality of the results from the crimping tools, combined with the ILME crimp contacts, is identical and at the highest market levels, exceeding the requirements of the standard EN 60352-2.

Although the crimping appliances and tools suggested here include a set of control automatisms and mechanisms, which prevent the chief misunderstandings and errors, the operator is advised to always take care not to work in inappropriate conditions.

The crimping operation

The practical guide in standard EN 60352-2 supplies further general information regarding crimp contacts for multipole connectors.

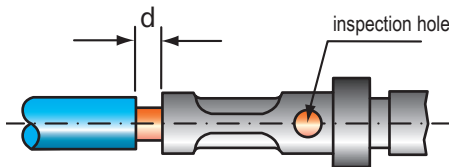
1. Insertion of the conductor in the crimp contacts

The conductor must be correctly positioned in the pin to be crimped.

The crimping indentations must be correctly positioned on the foot to be crimped. There must be sufficient space, in conformity with the manufacturer's instructions, between the end of the insulating material of the conductor and the pin to be crimped ("d").

As a general rule, the stripping length is equal to the pin insertion depth + 1 mm (for sections up to 1 mm²) and + 2 mm (for sections from 1 to 10 mm²) *. When using closed crimp pins with an inspection hole, the crimp conductor must be visible through the inspection holes.

* Keeping the conductor strands visible above the contact collar enables you to check correct, i.e. make sure no strands have been cut. This also ensures a certain flexibility for the connection, by not transmitting to the contact any flexure stresses caused by installation. However, in practice, some operators give priority to insulation, by reducing to zero the gap between cable insulation and the contact collar.



2. Insertion of crimped contacts in the connector insert

It is recommended that the crimped contacts be perfectly straight and inserted within the contact slots in a single operation and without excessive force until a clicking sound is heard.

The correct retention of the contact should be verified with a light pulling of the wire. Non alignment of the crimped contacts must be avoided because this could cause possible loosening of the retention springs and consequently jeopardise the retention of the contact in the insert.

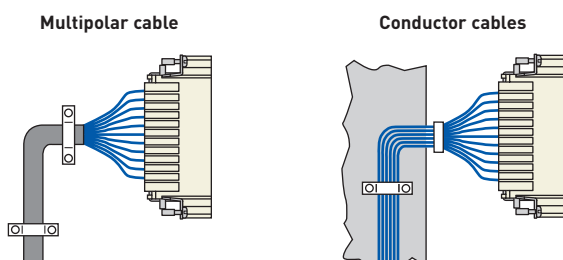
For small section conductors ($\leq 0,35 \text{ mm}^2$) or for specific application, the use of the insertion tool specified by the manufacturer is recommended.

3. Removal of inserted contacts

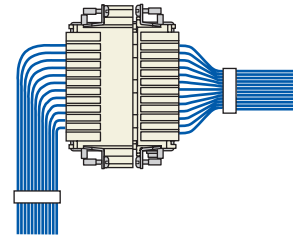
In the case of incorrect insertion or wiring substitution, inserted contacts may only be removed using the removal tools specified by the manufacturer.

4. Mounting and flexure of multi-wired bundles or multipolar cables with crimp contacts

Bundles of conductors or multipolar cables with crimp contacts for multipole connectors must not cause stress to the inserted contacts with their weight as this would cause the contacts to bend over to the coupling area of the connectors and consequently damage them. The connectors must therefore be provided with cable clamps or the conductor bundles or multipolar cables must be mounted as described in the figures below.



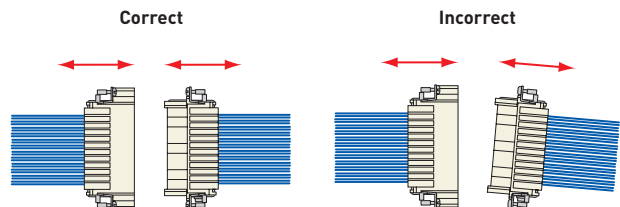
If the conductor bundles or the multipolar cables have to be immediately folded over on the back of the connector insert, it is recommended not to use any mechanical force in the axial direction with respect to the coupled contacts. The figure shows a correct bending and clamping of the multiwire bundles using the crimp contacts.



5. Coupling and uncoupling of multipolar connectors with crimp contacts

In order to prevent stress on the crimp contacts, the connectors must be coupled and uncoupled in the axial direction with respect to the contacts, without touching the conductor bundles or cables.

Standard DIN 43652 (incorporated into specification EN 175301-801) that applies to the ILME inserts of the CD series (this recommendation is also valid for the CDD series) prescribes a maximum deflection from the axis of $\pm 5^\circ$ on the greater side and $\pm 2^\circ$ on the smaller side.

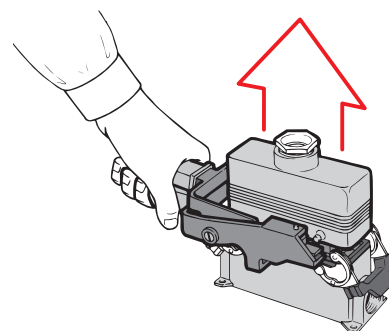


To keep the play within this limit, especially during the uncoupling phase, guide pins CRM and CRF may be used. The use of ILME pliers (code number CPES) is recommended for the uncoupling operations for CD inserts (64 poles) and CDD inserts (108 poles). The pliers work on the fulcrum and lever principle and perform the following main tasks:

I - Reduce effort and coupling times to the minimum, even when working in the most impractical and inaccessible points.

II - Perform the uncoupling of multipolar connectors in full conformity of standard DIN 43652 (now EN 175301-801).

The pliers allow the extraction of the inserts to be made perfectly axially with respect to the contacts, evenly distributing the pressure on four points (housing pins).



Tools and accessories for crimp contacts

for contacts of inserts series (as applicable): page:

CD	(10 A)	66 - 74
CDD	(10 A)	76 - 83
CDC	(16 A)	104 - 106
CCE	(16 A)	130 - 135
CMCE	(16 A)	137 - 145
CQE	(16 A)	168 - 173
CQEE	(16 A)	176 - 177
CQ	(10 A/16 A)	186 - 193
CX 8/24	(16 A/10 A)	194
CX 6/36 *	(10 A)	198
CX 12/2 *	(10 A)	199
RX 12/2 * (HNM)	(10 A)	221
CX 6/6 *	(16 A)	206
RD (HNM)	(10 A)	208 - 209
RDD (HNM)	(10 A)	210 - 213
RCE (HNM)	(16 A)	214 - 217
RQEE (HNM)	(16 A)	218 - 219
MIXO	(10 A/16 A)	271 - 306

* the underlined polarities indicate those contacts that require the tools shown in this page

manual crimping tool positioner - gauge



insertion tool - removal tools replacement tip

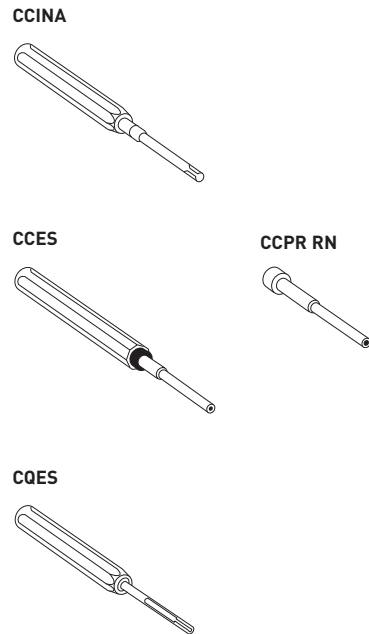
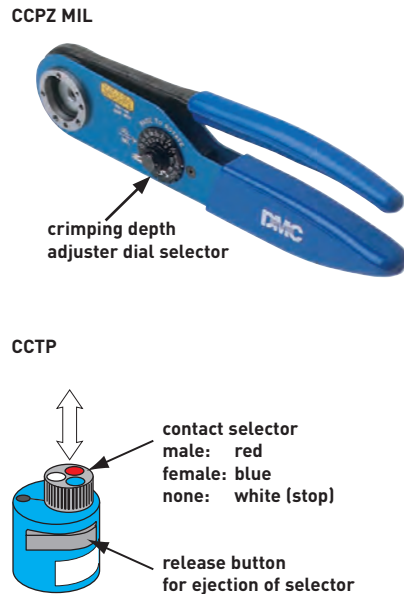
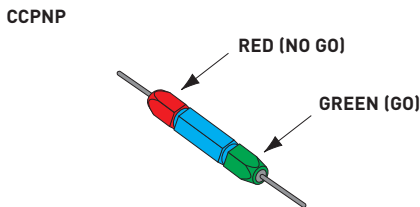


description	part No.	part No.
crimping tool for 10 A and 16 A contacts DANIELS AF8 model (turret excluded)	CCPZ MIL	
positioner inserts (see note) for 10 A contacts (CD and RD HNM series) for 16 A contacts (CC and RC HNM series)	CCTP 10 CCTP 16	
"go / no go" control gauge to verify indenter closure (see note)	CCPNP	
insertion tool for insertion of the contacts into the inserts for crimped contacts up to 0,75 mm ²		CCINA
removal tools for the extraction of contacts from the inserts for 10 A contacts (CD and RD HNM series) ¹⁾ for 16 A contacts (CC and RC HNM series) ²⁾		CCES CQES
replacement tip for CCES removal tool		CCPR RN

1) for CQ, CD, RD, CDD, RDD, CX, RX inserts (10 A auxiliary contacts) and MIXO module (10 A)
 2) for CQ, CQE, CQEE, RQEE, CCE, RCE, CMCE inserts (excluded 16+2), MIXO module (16 A), CX 6/6 (16 A) and CDC. For CMCE (16+2), CX inserts (contacts 16 A insert CX 8/24) using a flat 3 mm screwdriver.

Notes:
Positioner / Head turret
 conforms to international standard MIL-C-22520/1
 - An interchangeable and indispensable accessory of the CCPZ MIL crimping tool, it precisely positions the contact where crimping is performed. Each series of contacts requires its own turret.

"go / no go" control gauge
 conforms with international standard MIL-C-22520/3
 - A tool used to periodically check that the crimping tool meets standard requirements.



CC / RC series		0,14 mm ²	0,25 mm ²	0,34 mm ²	0,5 mm ²	0,75 mm ²	1,0 mm ²	1,5 mm ²	2,5 mm ²	3,0 mm ²	4,0 mm ²	conductor section	
red	blue												
male	female	26	24	22	20	18	17	16	14	12	12	AWG	
0,3	0,3	5	5	6								crimping depth adjuster selector	CCTP 16
0,5	0,5		6	6	7								
0,7	0,7			6	6	7							
1,0	1,0			6	6	7	7						
1,5	1,5				6	7	7	8					
2,5	2,5					6	6	7	7				
3,0	3,0						6	7	7				
4,0	4,0								7	8			

CD / RD series		0,14 mm ²	0,25 mm ²	0,34 mm ²	0,5 mm ²	0,75 mm ²	1,0 mm ²	1,5 mm ²	2,5 mm ²	conductor section	
red	blue										
male	female	26	24	22	20	18	17	16	14	AWG	
0,3	0,3	5	5	6						crimping depth adjuster selector	CCTP 10
0,5	0,5				6						
0,7	0,7					6					
1,0	1,0						6				
1,5	1,5							7			
2,5	2,5								7		

Use and maintenance instructions

1. General specifications

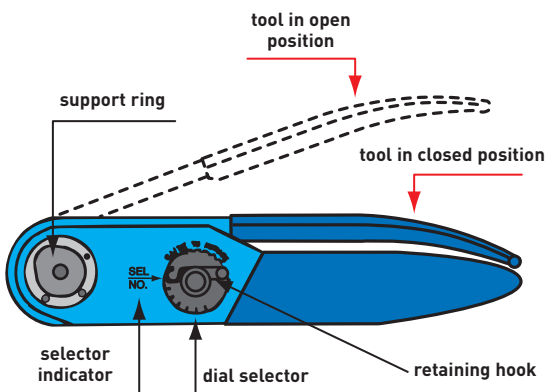
The **CCPZ MIL crimping tool** conforms to the international standard MIL-C-22520/1. Crimping is performed with 8 pressure points. The tool is equipped with a geared mechanism to control the complete crimping cycle. **The tool must be equipped with an interchangeable positioner (CCTP) according to the series of contacts to be crimped.**

1.1 Crimping range

Conductor cross-sectional area range:
from 0,14 mm² (26 AWG) to 4 mm² (12 AWG) for positioner 16 A,
from 0,14 mm² (26 AWG) to 2,5 mm² (14 AWG) for positioner 10 A

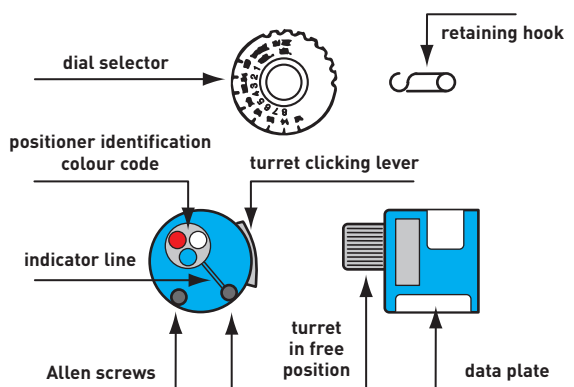
Caution!

The handle of the tool must be in the open position when the turret is installed, disassembled or opened. If not, the turret and the crimping tool may be damaged.



2. CCTP positioner installation

- 1 The crimping tool must be in the open position.
- 2 Press the clicking lever that releases the positioner in the adjustment position.
- 3 Position the previously selected CCTP positioner on the support ring located on the crimping tool (matching the special pin on the base of the turret with the corresponding hole on the support ring), aligning the tapped holes with the socket head screws.
- 4 With the CCTP positioner positioned against the support ring, tighten the socket head screws with the 3,5 mm Allen wrench (supplied with the kit).
- 5 Refer to the data plate on the CCTP positioner. From the colour code column, select the colour of the positioner that corresponds to the appropriate code and dimension of the contact to be crimped.
- 6 With the CCTP positioner in the adjustment position, turn the turret until the colour-coded positioner is aligned with the indicator line. Press the turret until it clicks into the connected position.
- 7 Refer to the data plate on the CCTP positioner. From the column indicating the proper conductor section, determine the number that corresponds to the contact being used.
- 8 Remove the retaining hook from the crimping tool dial selector. Lift the dial selector and turn it until the selector number is aligned with the indicator (SEL. NO.). Replace the retaining hook (if necessary).



3. Crimping instructions

- 1 Insert the contact and the prepared conductor through the opening of the indenter in the turret positioner.
- 2 Tighten the crimping tool handle until the stop gear is released. The tool will return to the open position.
- 3 Check the position of the crimping on the contact crimping foot. Ideally, the crimping should be between the inspection hole and the top edge of the crimping foot.
The head of the contact should not be squared and the inspection hole should be intact.

4. Removing the CCTP positioner

With the crimping tool in the open position, to disassemble the positioner, loosen the socket head screws using the 3,5 mm Allen key wrench (supplied with the kit). After the threads are released from the support ring, pull off the positioner with a straight movement.

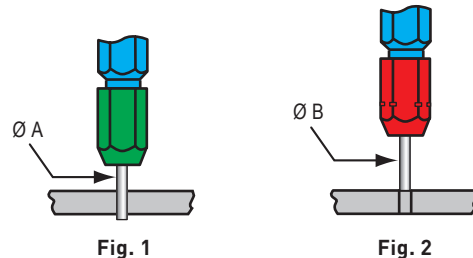
5. Instructions to check calibration

The operations to check the crimping tool must be carried out with the dial selector in position 4 and the CCPNP gauge.
ATTENTION! Do not crimp the gauge.

5.1 Calibration check

Put the crimping tool in the completely closed position.
"GO" - Insert the end (green) of the gauge as shown (Fig. 1). The gauge must pass freely between the indenter tips.
"NO GO" - Insert the end (red) of the gauge as shown (Fig. 2). The gauge should not pass through the opening.

Gauge	tool selector pos. No.	Ø A ± 0,00254 mm (GO) green	Ø B ± 0,00254 mm (NO GO) red
CCPNP	4	0,991 (mm)	1,118 (mm)
		0,0390 (in)	0,0440 (in)



6. Crimping tool maintenance

No maintenance is required.

However, it is good practice to keep the indenter tips free from residual deposits of the coloured band (some types of crimp contacts as per MIL standards are identified by coloured bands in the crimping area) and any other debris. A metal brush may be used for this purpose.

The following is strongly recommended:

- 1 DO NOT immerse the tools in a solution to clean them.
- 2 DO NOT brush oil in the tools to lubricate them.
- 3 DO NOT try to disassemble the tool or repair it.

This is a high-precision manual crimping tool and must be used as such. For automatic crimping operations refer to the CCPZP and/or CCPZPA crimping tool models.

Tools and accessories for crimp contacts

for contacts of inserts series (as applicable): page:

CD	(10 A)	66 - 74
CDD	(10 A)	76 - 83
CDC	(16 A)	104 - 106
CCE	(16 A)	130 - 135
CMCE	(16 A)	137 - 145
CQE	(16 A)	168 - 173
CQEE	(16 A)	176 - 177
CQ	(10 A/16 A)	186 - 193
CX 8/24	(16 A/10 A)	194
CX 6/12 *	(10 A)	197
CX 6/36 *	(10 A)	198
CX 12/2 *	(10 A)	199
RX 12/2 * (HNM)	(10 A)	221
CX 6/6 *	(16 A)	206
RD (HNM)	(10 A)	208 - 209
RDD (HNM)	(10 A)	210 - 213
RCE (HNM)	(16 A)	214 - 217
RQEE (HNM)	(16 A)	218 - 219
MIXO	(10 A/16 A)	271 - 306

* the underlined polarities indicate those contacts that require the tools shown in this page

manual crimping tool



front view showing incorporated crimping dies

insertion tool

removal tools - tip



description

part No.

part No.

crimping tool for **10 A** and **16 A** contacts
RENNSTEIG model (crimping dies and
turret head are included)

CCPZ TP

insertion tool

for insertion of the contacts into the inserts
for crimped contacts up to 0,75 mm²

CCINA

removal tools

for the extraction of contacts from the inserts
for **10 A** contacts (**CD** and **RD HNM** series) ¹⁾
for **16 A** contacts (**CC** and **RC HNM** series) ²⁾

CCES
CQES

replacement tip

for CCES removal tool

CCPR RN

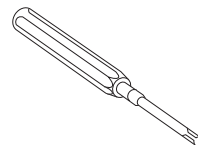
- ¹⁾ for CQ, CD, RD, CDD, RDD, CX, RX inserts
(10 A auxiliary contacts) and MIXO module (10 A)
²⁾ for CQ, CQE, CQEE, RQEE, CCE, RCE, CMCE inserts
(excluded 16+2), MIXO module (16 A), CX 6/6 (16 A)
and CDC. For CMCE (16+2), CX inserts (contacts 16 A
insert CX 8/24) using a flat 3 mm screwdriver.

CCPZ TP

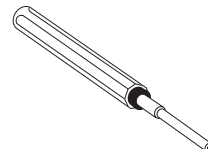


rear view showing incorporated turret head
positioner

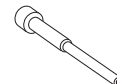
CCINA



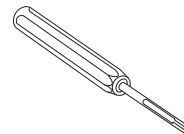
CCES



CCPR RN



CQES



CCPZ TP is a simple but effective "square shaping"
manual crimping tool incorporating discrete (4-size
nests) crimping dies and dedicated turret positioner for
relevant crimp contacts series and sizes.

For series CD (10 A) and CC (16 A) contacts (and
their corresponding **HNM** variants series RD and RC)
manual crimping tool **CCPZ MIL** – or their equivalent
pneumatic **CCPZP** or **CCPZPA** for large volumes of
crimps, or even the fully automatic stripper crimper
machine **ZFU** – as well as the universal crimping
tool **CCPZ RN**, by providing 8-indent crimping, are
recommended for highly demanding applications, such
as in transportation.

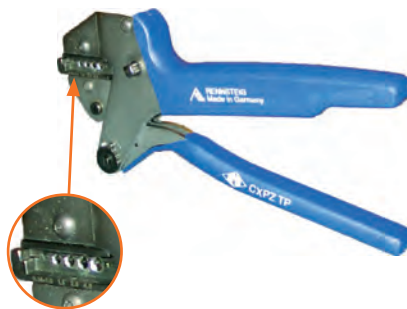
Tools and accessories for crimp contacts

for contacts of inserts series (as applicable): page:

CQ4 02	(40A)	182
CQ4 02 H	(40A)	183
CQ4 03	(40A)	184
CQ 04/2 *	(40A/10A)	191
CX 6/12 *	(40 A)	197
CX 6/36 *	(40 A)	198
CX 12/2 *	(40 A)	199
RX 12/2 * (HNM)	(40 A)	221
MIXO	(40 A)	267 - 272

* the underlined polarities indicate those contacts that require the tools shown in this page

manual crimping tool



front view showing incorporated crimping dies

removal tool



description	part No.	part No.
-------------	----------	----------

crimping tool for **40 A** contacts
RENNSTEIG model (crimping dies and
turret head are included)

CXPZ TP

removal tool

for the extraction of contacts from the inserts
for **40 A** contacts (**CX** and **RX HNM**) ¹⁾ and cables $\varnothing \leq 5$ mm
for **40 A** contacts (**CX** and **RX HNM**) ²⁾ and cables $\varnothing \leq 7,5$ mm

CXES
CXES-10

¹⁾ for CX, RX inserts (40 A contacts) and MIXO module (40 A)

²⁾ for MIXO module CX 03 4B and contacts 10 mm².

CXPZ TP is a simple but effective "square shaping" manual crimping tool incorporating discrete (3-size nests) crimping dies and turret positioner for relevant crimp contacts sizes ranging from size 1.5 to size 6.0. Size 10 requires **CCPZ RN** (Rennsteig PEW 8.75 universal manual crimp tool) or **CXPZP D** (Daniels WA27-309-EP pneumatic tool)

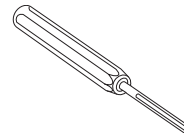
For series CX (40 A) contacts (and their corresponding **HNM** variants series RX) manual crimping tool **CXPZ D** (Daniels M309) up to size 6.0 or **CCPZ RN** (Rennsteig PEW 8.75) for all sizes – or the pneumatic **CXPZP D** for large volumes of crimps, by providing 8-indent crimping, are recommended for highly demanding applications, such as in transportation.

CXPZ TP



rear view showing incorporated turret head positioner

CXES - CXES-10



Tools and accessories for crimp contacts

for contacts of inserts series (as applicable): page:

CQ4 02	(40A)	182
CQ4 02 H	(40A)	183
CQ4 03	(40A)	184
CQ <u>04</u> /2 *	(40A/10A)	191
CX <u>6</u> /12 *	(40 A)	197
CX <u>6</u> /36 *	(40 A)	198
CX <u>12</u> /2 *	(40 A)	199
RX <u>12</u> /2 * (HNM)	(40 A)	221
MIXO	(40 A)	267 - 272

* the underlined polarities indicate those contacts that require the tools shown in this page

manual crimping tool positioner - gauge



removal tool



description	part No.	part No.
-------------	----------	----------

crimping tool for **40 A** contacts up to size 6.0 ¹⁾
DANIELS M309 model (turret excluded) **CXPZ D**

positioner (see note)
for contacts **40 A** (CX and RX HNM series) **CXTP 40**

"go / no go" control gauge
to verify indenter closure (see note) **CXPNP**

removal tool
for the extraction of contacts from the inserts
for **40 A** contacts (CX and RX HNM) ²⁾ and cables $\varnothing \leq 5$ mm
for **40 A** contacts (CX and RX HNM) ³⁾ and cables $\varnothing \leq 7,5$ mm

CXES
CXES-10

- 1) for all sizes including 10 see crimping tools on pages 714 (CCPZ RN) and 726 (CXPZP D).
- 2) for CX, RX inserts (40 A contacts) and MIXO module (40 A)
- 3) for MIXO module CX 03 4B and contacts 10 mm².

Notes:

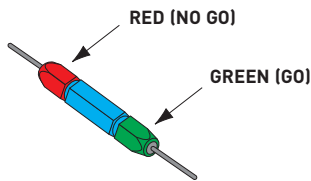
Positioner

- An interchangeable and indispensable accessory of the CXPZ D crimping tool, it precisely positions the contact where crimping is performed.

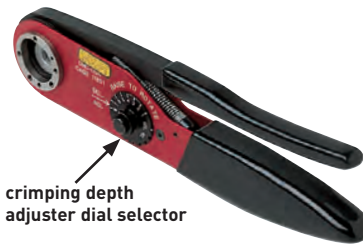
"go / no go" control gauge

- A tool used to periodically check that the crimping tool meets standard requirements.

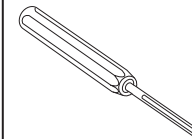
CXPNP



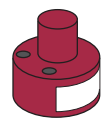
CXPZ D



CXES - CXES-10



CXTP 40



CXTP 40

CONTACT	CX / RX	1.5	2.5	4.0	6.0	10
WIRE SIZE	mm ²	1,5	2,5	4	6	10
	AWG	16	14	12	10	8
SEL. NO.		5	5	5	7	8
USE WITH		M309				
		WA-27-309-EP				

Use and maintenance instructions

1. General specifications

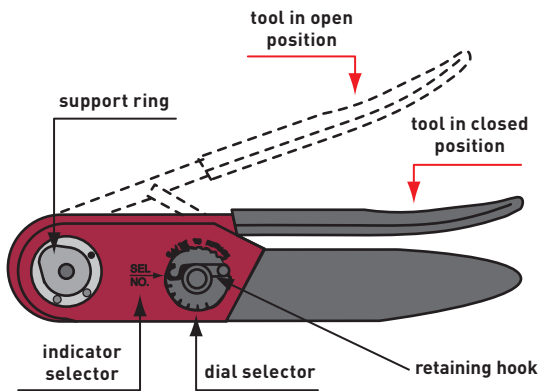
The **CXPZ D crimping tool** performed with 8 pressure points.
 The tool is equipped with a geared mechanism to control the complete crimping cycle.
The tool must be equipped with an interchangeable turret (CXTP) according to the series of contacts to be crimped.

1.1 Crimping range

Conductor cross-sectional area range: from 1,5 mm² (16 AWG) to 6 mm² (10 AWG).

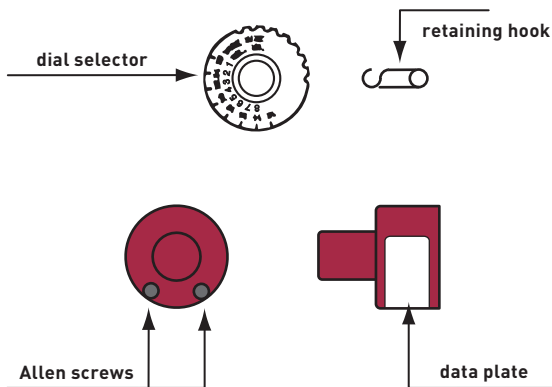
Caution!

The handle of the tool must be in the open position when the turret is installed, disassembled or opened. If not, the turret and the crimping tool may be damaged.



2. CXTP positioner installation

- 1 The crimping tool must be in the open position.
- 2 Position the CXTP 40 positioner on the support ring located on the crimping tool (matching the special pin on the base of the turret with the corresponding hole on the support ring), aligning the tapped holes with the socket head screws.
- 3 With the CXTP 40 positioner positioned against the support ring, tighten the socket head screws with the 3,5 mm Allen wrench (supplied with the kit).
- 4 Refer to the data plate on the CXTP 40 positioner.
 From the column indicating the proper conductor cross-sectional area, determine the number that corresponds to the contact being used.
- 5 Remove the retaining hook from the crimping tool dial selector.
 Lift the dial selector and turn it until the selector number is aligned with the indicator (SEL.NO.).
 Replace the retaining hook (if necessary).



3. Crimping instructions

- 1 Insert the contact and the prepared * conductor through the opening of the indenter in the turret positioner.
- 2 Tighten the crimping tool handle until the stop gear is released.
 The tool will return to the open position.
- 3 Check the position of the crimping on the contact crimping foot. Ideally, the crimping should be between the inspection hole and the top edge of the crimping foot.
The head of the contact should not be squared and the inspection hole should be intact.

* i.e. stripped at the correct length and with strands lightly twisted to recover regular lay of strands

4. Removing the CXPT positioner

With the crimping tool in the open position, to disassemble the turret, loosen the socket head screws using the 3,5 mm Allen wrench (supplied with the kit).
 After the threads are released from the support ring, pull off the positioner with a straight movement.

5. Instructions to check calibration

The operations to check the crimping tool must be carried out with the dial selector in position 4 and with the CXPNP gauge (formerly Daniels G425, now Daniels G436 or G1004 which are equivalent for the purpose).
ATTENTION! Do not crimp the gauge.

5.1 Calibration check

- Put the crimping tool in the completely closed position.
 "GO" - Insert the end (green) of the gauge as shown (Fig. 1).
 The gauge must pass freely between the indenter tips.
 "NO GO" - Insert the end (red) of the gauge as shown (Fig. 2).
 The gauge should not pass through the opening.

Gauge	tool selector pos. No.	Ø A ± 0,00254 mm (GO) green	Ø B ± 0,00254 mm (NO GO) red
CXPNP	4	1,549 (mm)	1,676 (mm)
		0,0609 (in)	0,0659 (in)

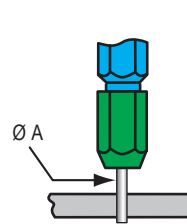


Fig. 1

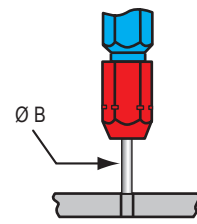


Fig. 2

6. Crimping tool maintenance

No maintenance is required.
 However, it is good practice to keep the indenter tips free from residual deposits of the coloured band (some types of crimp contacts as per MIL standards are identified by coloured bands in the crimping area) and any other debris.
 A metal brush may be used for this purpose.
 The following is strongly recommended:

- 1 DO NOT immerse the tools in a solution to clean them.
- 2 DO NOT brush oil in the tools to lubricate them.
- 3 DO NOT try to disassemble the tool or repair it.

This is a high-precision manual crimping tool and must be used as such.

Tools and accessories for crimp contacts

for contacts of inserts series (as applicable): page:

CD	(10 A)	66 - 74
CDD	(10 A)	76 - 83
CDC	(16 A)	104 - 106
CCE	(16 A)	130 - 135
CQE	(16 A)	168 - 173
CQEE	(16 A)	176 - 177
CMCE	(16 A)	137 - 145
CQ4	(40A)	182 - 184
CQ	(10 A/16 A)	186 - 193
CX 8/24	(16 A/10 A)	194
CX 6/36	(40 A/10 A)	198
CX 12/2	(40 A/10 A)	199
RX 12/2 (HNM)	(40 A/10 A)	221
CX 6/6 *	(16 A)	206
RD (HNM)	(10 A)	208 - 209
RDD (HNM)	(10 A)	210 - 213
RCE (HNM)	(16 A)	214 - 217
RQEE (HNM)	(16 A)	218 - 219
MIXO	(40 A/16 A/10 A)	267 - 306

* the underlined polarities indicate those contacts that require the tools shown in this page

manual crimping tool gauge



insertion tool - removal tools replacement tip



description	part No.	part No.
crimping tool for 10A, 16A and 40A contacts RENNSTEIG model (turret included)	CCPZ RN	
"go / no go" control gauge to verify indenter closure (see note)	CCPNP RN	
insertion tool for insertion of the contacts into the inserts for crimped contacts up to 0,75 mm ²		CCINA
removal tools for the extraction of contacts from the inserts for 10A contacts (CD / RD HNM) ¹⁾ for 16A contacts (CC / RC HNM) ²⁾ for 40A contacts (CX / RX HNM) ³⁾ and cables $\varnothing \leq 5$ mm for 40A contacts (CX / RX HNM) ⁴⁾ and cables $\varnothing \leq 7,5$ mm		CCES CQES CXES CXES-10
replacement tip for CCES removal tool		CCPR RN

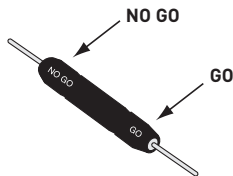
- 1) for CQ, CD, RD, CDD, RDD, CX, RX inserts (10 A auxiliary contacts) and MIXO module (10 A)
- 2) for CQ, CQE, CQEE, RQEE, CCE, RCE, CMCE inserts (excluded 16+2), MIXO module (16 A), CX 6/6 (16 A) and CDC. For CMCE (16+2), CX inserts (contacts 16 A insert CX 8/24) using a flat 3 mm screwdriver.
- 3) for CX, RX inserts (40 A contacts) and MIXO module (40 A)
- 4) for MIXO module CX 03 4B and contacts 10 mm².

Notes:

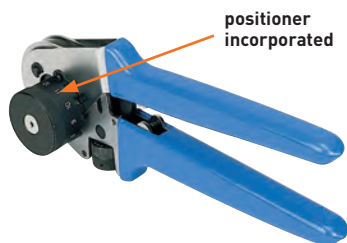
"go / no go" control gauge

- A tool used to periodically check that the crimping tool meets standard requirements.

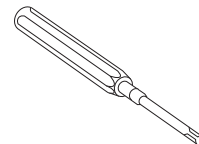
CCPNP RN



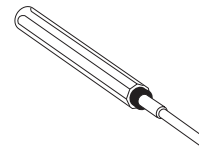
CCPZ RN



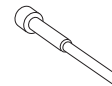
CCINA



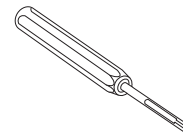
CCES



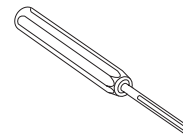
CCPR RN



CQES



CXES - CXES-10



Watch our online tutorial

Use and maintenance instructions

1. General specifications

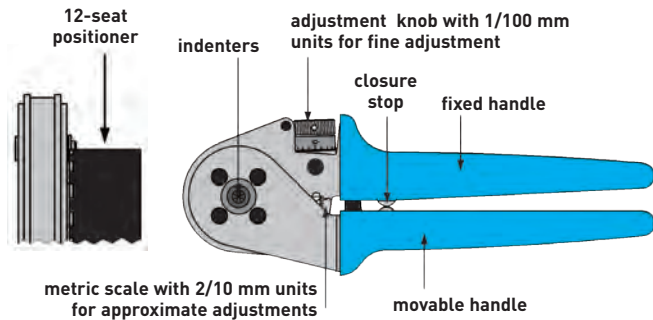
The **CCPZ RN crimping tool** crimps with 8 pressure points, obtaining similar results to the prescriptions of standard MIL-C-22520/1.

The tool has a geared mechanism for controlling the complete crimping cycle, and houses a positioning turret with 12 positions, six of which can be used for positioning the ILME male and female crimping contacts of series CD (10A max), CC (16A max) and CX (40 A max).

1.1 Crimping range

Conductor cross-sectional area range: from 0,14 mm² (26 AWG) to 10 mm² (8 AWG).

Caution! The handle of the tool must be in the open position when the turret is installed, disassembled or opened. If not, the turret and the crimping tool may be damaged.



2. Description of tool

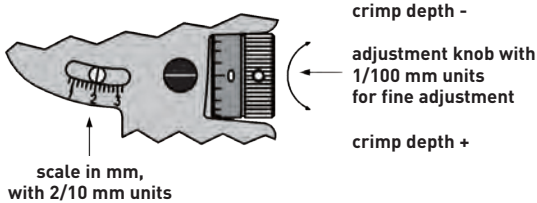
Crimping tool components: a first mobile handle, with a precision stop mechanism with teeth and an opening limiting guide; a second fixed handle with metric scale (units of 2/10 mm); an adjustment system with fine step adjustments of 1/100 mm; four indenters; a 12-seat positioner, fully rotating through 360° for accurate positioning of contacts. A reference table engraved on the tool surface provides the positioner (POS) number and crimping depth (SET) to select according to the type and size of the ILME contact (the crimping tool can be set to any crimping depth which may be required by the contact manufacturer).

3. Adjustment of crimp depth

Crimp depth to be adjusted as follows: the adjustment knob should be turned clockwise to reduce crimping depth, and anti-clockwise to increase it.

3.1 Adjustment tolerances:

- 1 scale mark on the knob = adjustment of 1/100 mm (0,01 mm);
- 1 complete rotation of knob = adjustment of 2/10 mm (0,2 mm, this indication can be read on the knob and on the approximate scale);
- 5 knob rotations = adjustment of 1,0 mm (this indication can be read on the scale).



4. Crimping instructions

The reference matrix on the crimping tool indicates the correct seat of the positioner (POS M1, F2, M3, F4, M5, F6) to select, and the crimping depth (SET) to adjust for the contact to be crimped.

The contact is inserted through the crimper entry hole on the opposite side of the positioner.

The contact is closed by closing the handles in the first stop position, in order to prevent the contact coming out off the crimper and to facilitate fitting the conductor in the contact.

The precision stop mechanism with teeth ensures consistently precise crimps, by forcing the crimper to close completely and finish the crimping cycle before the crimper can be re-opened.

Tool adjustment

Positioner seat = M1 (male) - F2 (female)

CDMA/D - RDM2D (male) CDFA/D - RDF2D (female)	Section (mm ²)	Crimp depth (mm)
0,3	0,14	1,3
	0,25	
	0,37	
0,5	0,5	1,55
0,7	0,75	1,55
1,0	1,0	1,55
1,5	1,5	1,55
2,5	2,5	1,55

Positioner seat = M3 (male) - F4 (female)

CCMA/D - RCM2D (male) CCFA/D - RCF2D (female)	Section (mm ²)	Crimp depth (mm)
0,3	0,14	1,2
	0,25-0,37	1,3
0,5	0,5	1,55
0,7	0,75	1,55
1,0	1,0	1,55
1,5	1,5	1,8
2,5	2,5	1,8
3,0	3,0	1,9
4,0	4,0	2,0

Positioner seat = M5 (male) - F6 (female)

CXMA/D - RXM2D (male) CXFA/D - RXF2D (female)	Section (mm ²)	Crimp depth (mm)
1,5	1,5	1,55
2,5	2,5	1,8
4,0	4,0	2,0
6,0	6,0	2,5
10,0	10,0	2,3

5. Calibration check

The crimping tool is adjusted in the manufacturer's plant. To ensure correct calibration, we advise you to check the tool with a gauge every working day.

This is easily done with the CCPNP RN cylindrical gauge in the 2,0 mm Ø position.

ATTENTION! Do not crimp the gauge.

Crimp depth of 2 mm can be adjusted with the adjustment knob (scale marked on "2", screw indicator on "0" as shown in the above figure).

Put the crimping tool in the completely position.

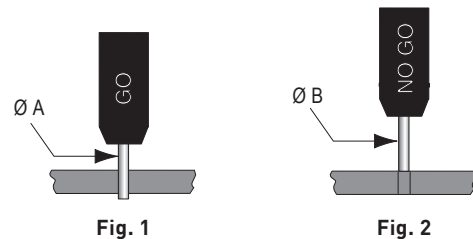
"GO" - Insert the end of the gauge as shown (Fig. 1).

The gauge must pass freely between the indenter tips.

"NO GO" - Insert the end of the gauge as shown (Fig. 2).

The gauge should not pass through the opening.

Gauge	tool selector pos. No.	Ø A	Ø B
CCPNP RN	2,00 (mm)	1,94 (mm)	2,06 (mm)



6. Maintenance and repair

Keep the crimping tool clean and store it correctly when not in use.

The joints need to be lubricated periodically, and the pin stop circular clips must always stay in position.

This is a high precision crimping tool and must be used as such.

Tools and accessories for crimp contacts

for contacts of inserts series (as applicable): page:

CQ (CI, RI HNM contacts, 21 poles) (5 A)	190
MIXO (CI, RI HNM contacts, 25 poles)	284
MIXO Gigabit (CI contacts, 8 poles)	286
MIXO BUS (CI contacts, 8 poles) (5 A)	293
MIXO D-SUB (CI contacts, 9 poles) (5 A)	296

manual crimping tool positioner - gauge



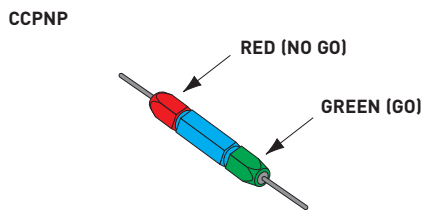
N.B.:
CITP D positioner
(to be ordered separately)

insertion / removal tool



description	part No.	part No.
crimping tool for CI, RI HNM contacts DANIELS AFM8 model (positioner excluded)	CIPZ D	
positioner (DANIELS K1450I) for CI, RI HNM contacts (CIFA - CIMA; CIFD - CIMD; CIF2D - CIM2D; CIFJD - CIMJD; RIFD - RIMD series)	CITP D	
"go / no go" control gauge (DANIELS G125) to verify indenter closure (see note)	CCPNP	
insertion tool: for insertion of the contacts into the inserts, and removal tool: for the extraction of contacts from the inserts for CI, RI HNM contacts 0,2 - 0,5 mm ² (CIFA - CIMA; CIFD - CIMD; CIF2D - CIM2D; CIFJD - CIMJD; RIFD - RIMD series)		CIVES
for CI, RI HNM contacts 0,75 mm ² (CIFA - CIMA; CIFD - CIMD; CIF2D - CIM2D; CIFJD - CIMJD; RIFD - RIMD Series)		CIES B

Notes:
"go / no go" control gauge
conforms with international standard MIL-C-22520/3
- A tool used to periodically check that the crimping tool meets standard requirements.



CIFA - CIMA - CIFD - CIMD	
CIF2D - CIM2D - CIFJD - CIMJD	
RIFD - RIMD	
WIRE mm ²	0,08-0,75
WIRE AWG	28 - 18
SEL NO.	7

CITP D



Watch our online tutorial

Use and maintenance instructions

1. General specifications

The **CIPZ D crimping tool** (Daniels designation AFM8) conforms to the U.S. Military Standard **MIL-C-22520/2C** (designation M22520/2-01) ¹⁾. Crimping is performed with 8 pressure points and the tool is equipped with a geared mechanism to control the complete crimping cycle.

The tool must be equipped with an interchangeable positioner (CITP D) according to the series of contacts to be crimped.

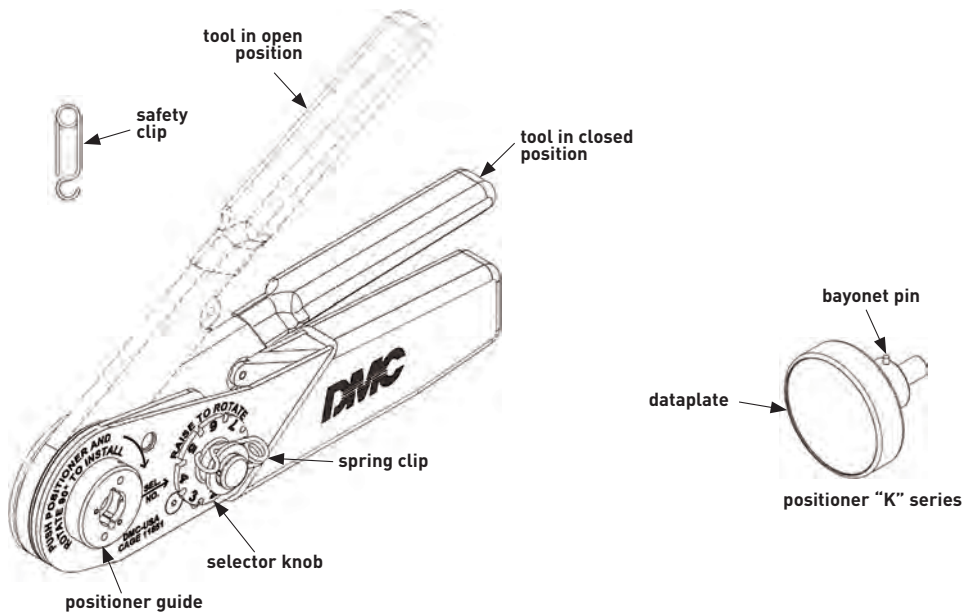
¹⁾ Since October 2011 the MIL-C-22520 series is being progressively replaced by a corresponding **SAE ¹⁾ AS22520** series. The military series will be fully cancelled once all SAE parts will be published. SAE International, so named since 2006 and established in 1905 as the *Society of Automotive Engineers*, is a U.S.-based, globally active professional association and standards developing organization working in various industries, having as core business the transport industries such as automotive, aerospace, and commercial vehicles.

2. Crimping range

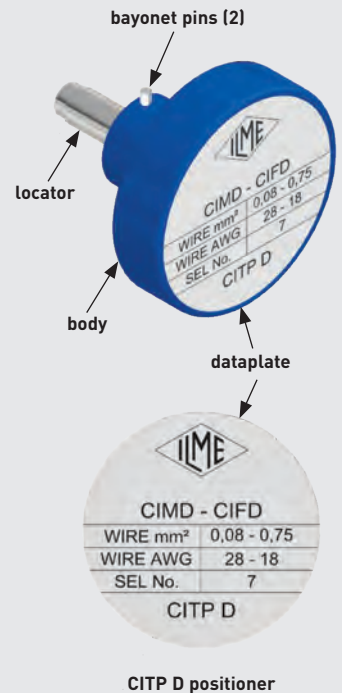
Conductor cross-sectional area range: from 0,08 mm² (28 AWG) to 0,52 mm² (20 AWG).

Caution!

The handle of the tool must be in the open position when the positioner is installed, disassembled or opened. If not, the positioner and the crimping tool may be damaged.



Note: dimensions in inches



3. CITP D positioner installation

- 1 The crimping tool must be in the open position.
- 2 Remove the safety clip from the positioner guide.
- 3 Insert the previously selected **CITP D** positioner into the positioner guide on the head of the tool. Push down and rotate 90 degrees until bayonet pins lock.
- 4 Refer to the data plate on the **CITP D** positioner for the setup of the selector number that determines crimp height, based on the contact size and conductor size.
- 5 With the tool in open position, remove the spring clip then raise and rotate selector knob until number indicated on data plate for conductor size to be crimped is in line with SEL. NO. arrow. Reinstall spring clip to avoid unintended change of setup

4. Crimping instructions

- 1 Insert the contact and the prepared (correctly stripped) conductor through the indenter opening in the positioner.
- 2 Squeeze the crimping tool handles together until ratchet releases. Handles will return to open position.
- 3 Check the position of the crimping on the contact crimp barrel. Ideally, the crimping should be between the inspection hole and the top edge of the crimp barrel.

The edge of the contact barrel should not result squared and the inspection hole should remain intact.

5. Removing the CITP D positioner

With the crimping tool in the open position, to disassemble the positioner, push down on the positioner to release the bayonet pins from the positioner guide. Turn 90 degrees anticlockwise and remove the positioner from the tool.

6. Instructions to check calibration

The operations to check the crimping tool must be carried out with the dial selector in position 8 and the CCPNP gauge.

CAUTION! Do not crimp gauge!

6.1 Calibration check

Put the crimping tool in the completely closed position.

“GO” - Insert the end (green) of the gauge as shown (Fig. 1).

The gauge must pass freely between the indenter tips.

“NO GO” - Insert the end (red) of the gauge as shown (Fig. 2).

The gauge should not pass through the opening.

Gauge	tool selector pos. No.	$\varnothing A \pm 0,00254$ mm (GO) green	$\varnothing B \pm 0,00254$ mm (NO GO) red
CCPNP	8	0,991 (mm) 0,0390 (in)	1,118 (mm) 0,0440 (in)

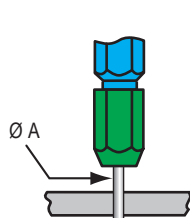


Fig. 1

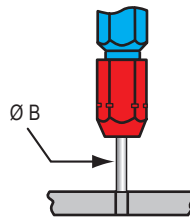


Fig. 2

7. Crimping tool maintenance

No maintenance is required. However, it is good practice to keep the indenter tips free from residual deposits of the coloured band (some types of crimp contacts as per SAE (MIL) standards are identified by coloured bands in the crimping area) and any other debris. A small wire brush may be used for this purpose.

The following is strongly recommended:

- 1 DO NOT immerse the tools in a solution to clean them.
- 2 DO NOT brush oil in the tools to lubricate them.
- 3 DO NOT try to disassemble the tool or repair it.

This is a high-precision manual crimping tool and must be used as such.



Tools and accessories for crimp contacts

for contacts of inserts series (as applicable): page:

CX 6/6 (100 A) **206**
MIXO (200 A/100 A/70 A) **262 - 266**

manual crimping tool
 crimping dies



removal tool



description	part No.	part No.
crimping tool for 70 A/100 A/200 A series contacts basic tool mod. CEMBRE HT 45 excluding crimping dies and locators ¹⁾	CPPZ C	
crimping dies for CX7 contacts with 10 mm ² (AWG 8 - 7) section	CGD 10 C	
for CX7 contacts with 16 mm ² (AWG 6 - 5) section	CGD 16 C	
for CX7 contacts with 25 mm ² (AWG 4 - 3) section	CGD 25 C	
crimping dies for CG contacts with 10 mm ² (AWG 8 - 7) section	CGD 10 C	
for CG contacts with 16 mm ² (AWG 6 - 5) section	CGD 16 C	
for CG contacts with 25 mm ² (AWG 4 - 3) section	CGD 25 C	
for CG contacts with 35 mm ² (AWG 2) section	CGD 35 C	
crimping dies for CY contacts section 16 mm ² (AWG 6)	CGD 25 C	
for CY contacts section 25 mm ² (AWG 4) and section 35 mm ² (AWG 2)	CYD 35 C	
for CY contacts section 50 mm ² (AWG 1)	CYD 50 C	
for CY contacts section 70 mm ² (AWG 2/0)	CYD 70 C	
locator for CX7 contacts	CX7PZ LOC	
for CG contacts	CGPZ LOC	
for CY contacts	CYPZ LOC	
removal tool for 70A CX7 series contact		C7ES

¹⁾ part No. **CPPZ CF**: manual crimping tool carrying case (CGPZ VLG) complete with crimping tool (CPPZ C), crimping dies (CGD/CYD) and locator (CX7PZ LOC, CGPZ LOC, CYPZ LOC).

NOTE:

For **CGMA 35** and **CGFA 35** contacts, and their corresponding **CGD 35 C** matrix pair, the contact may be inserted even after closing the head.

part No.	punching	contacts	AWG min [mm ²]		
			mm ²	AWG min [mm ²]	AWG max [mm ²]
CGD 10 C	ME 2	CX7MA 10, CX7FA 10, CGT 6.0, CGT 10	10	8 (8,4)	7 (10,6)
CGD 16 C	ME 3	CX7MA 16, CX7FA 16	16	6 (13,3)	5 (16,8)
CGD 25 C	ME 5	CX7MA 25, CX7FA 25	25	4 (21,2)	3 (26,7)
CGD 10 C	ME 2	CGMA 10, CGFA 10	10	8 (8,4)	7 (10,6)
CGD 16 C	ME 3	CGMA 16, CGFA 16, CGT 16	16	6 (13,3)	5 (16,8)
CGD 25 C	ME 5	CGMA 25, CGFA 25, CGT 25	25	4 (21,2)	3 (26,7)
CGD 35 C	ME 7	CGMA 35, CGFA 35	35	—	2 (33,6)
CGD 25 C	ME 5	CYMA 16, CYFA 16	16	6 (13,3)	—
CYD 35 C	ME 9	CYMA 25, CYFA 25	25	4 (21,2)	—
		CYMA 35, CYFA 35	35	2 (33,6)	—
CYD 50 C	ME 12	CYMA 50, CYFA 50	50	1 (42,4)	—
CYD 70 C	ME 17	CYMA 70, CYFA 70	70	2/0 (67,4)	—



Watch our online tutorial

Use and maintenance instructions

General specifications

The **CPPZ C crimping tool** is a hydraulically operated tool suitable for manually crimping contact series (70A/100A/200A max) removable crimp contacts which may be used in MIXO series type **CX7**, **CG**, **CY** and **CGT** adaptors. By using a suitable, hexagonal footprint crimp matrix pair, these pliers allow crimped connections to be made which conform to the highest quality standards.

The main features of these pliers are listed below:

- Scope of application: suitable for crimping wire terminals for up to 150 mm² flexible copper wires.
- Force developed: 50 kN (6 tons).
- Nominal operating pressure: 600 bar (8.600 psi).
- Dimensions: length 346 mm (13,6");
 - width (locked moving handle) 130 mm (5,1");
 - width (free moving handle) 250 mm (9,8").
- Weight: (without matrixes and without ILME locator) 2,0 kg (4,4 lbs).
- Recommended oil: AGIP ARNICA 32 or SHELL TELLUS OIL TX 32 or equivalent.
- Other features: please read the user and maintenance manual supplied with the tool.

The pliers are equipped with a locator specifically designed for ILME crimp contacts to be mounted on the moving part of the pliers head by means of the Allen screw provided.

NOTE: It is possible to use the CPPZ C pliers with the CX7 70 A, CG 100 A and CY 200 A contact series, by simply fitting the CX7PZ LOC, CGPZ LOC or CYPZ LOC locator and crimping matrixes to be purchased separately.

WARNING: For crimping the CGT adaptors, the crimp locating operation must be carried out by the user.

User instructions

1. Preliminary operations

According to requirements, the pliers can be fitted with one or more pairs of crimp matrixes selected from the matrixes listed in the catalogue, to crimp the contacts shown in the table page 720.

NOTE: The crimp contacts are only suitable for crimping flexible copper wires featuring a nominal section shown in the table with the crimp matrixes shown in the table. Any contacts – wires – matrixes combination which does not conform to these instructions is not physically possible (ex: using 35 mm² contacts with CGD 25 C matrixes is not possible because the pliers head would not close) or produces non conforming crimped connections or not usable in the MIXO series.

Open the tool head by moving the matrix supporting hook ③ outwards until the matrix support ① is released.

With reference to **Figures 1 and 2**, select a pair of matrixes suitable to the type of contact and insert them in the housings: one in the matrix support ①, the other one in the matrix pusher support ②. (NB: the two matrixes of each pair are the same).

Insert the contact by resting it in the locator with the tip forward, then close the head.

The contact crimp housing will be accessible in the mouth between the matrixes.

Remove the moving handle ④ by removing the handle locking belt from the handle.

Before carrying out the next operations, make sure the head is fully closed to avoid damages.

The pliers head can rotate by 180° in relation to the body, thus allowing the operator to work in the most comfortable position.

WARNING: do not force the head by trying to rotate it when the tool is under pressure.

2. Approaching the matrixes

If possible closing the dies, rest the pliers head on a work top, then move the moving handle to start moving the matrixes closer to the contact, then carry on moving them until the contact is locked between the matrixes.

Push the correctly stripped and suitable long (15 mm) wire all the way in the contact (or the CGT adaptors) crimp housing by carefully checking that the braids are fully compacted, are not damaged and, above all, are all fully inserted. Correctly pushing the contact in the locator ensures that the matrixes are exactly in the right area to compress (the contact crimp shaft centre). Make sure that the locator is free from any residue which would alter

the position of the contact. For crimping the CGT 16 earth adaptor, manually locate the area to be crimped between the matrixes. If necessary, re-open the matrixes by following the instructions described in paragraph 4 and reposition the contact.

3. Crimping

Continue to operate the moving handle (pumping): the piston will gradually move forward until the matrixes come into contact.

Continue the pumping action until the maximum pressure valve clicks in.

4. Releasing the dies

Fully press the pressure release lever ⑤ located on the pliers pumping body until the piston goes back and the matrixes open.

To remove the crimped contact, re-open the pliers head.

5. Storage

Fully return the piston as described in paragraph 4, then lock the moving handle in position by using the belt provided.

Cleaning and maintenance

The tool is very sturdy and does not require any special care; a correct operation is ensured by following a few simple precautions.

The tool is supplied with a user and maintenance manual, which gives all detailed instructions. Read this manual before use.

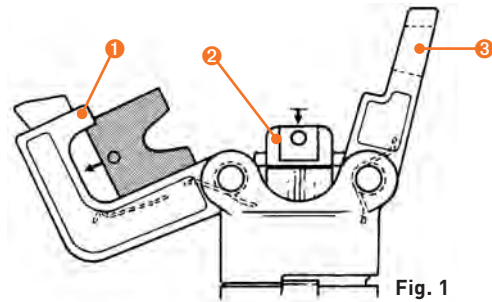


Fig. 1

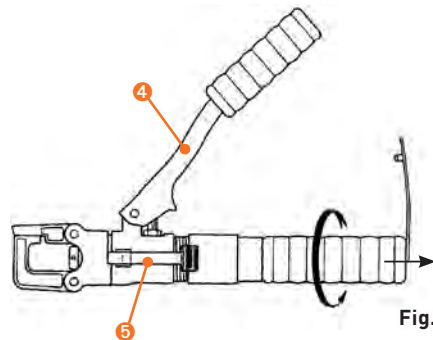


Fig. 2

CGPZ VLG carrying case



- for CPPZ C * crimping tool
- dimensions 445 x 290 x h 95 mm
- weight 1,2 kg
- houses 20 pairs of matrixes

* to store the CPPZ C crimping tool inside the carrying case, turn the pliers head by 180° so that the locator becomes visible.

Tools and accessories for crimp contacts

for contacts of inserts series (as applicable): page:

CD	(10 A)	66 - 74
CDD	(10 A)	76 - 83
CDC	(16 A)	104 - 106
CCE	(16 A)	130 - 135
CMCE	(16 A)	137 - 145
CQE	(16 A)	168 - 173
CQEE	(16 A)	176 - 177
CQ	(10 A/16 A)	186 - 193
CX 8/24	(16 A/10 A)	194
CX 6/36 *	(10 A)	198
CX 12/2 *	(10 A)	199
RX 12/2 * (HNM)	(10 A)	221
CX 6/6 *	(16 A)	206
RD (HNM)	(10 A)	208 - 209
RDD (HNM)	(10 A)	210 - 213
RCE (HNM)	(16 A)	214 - 217
RQEE (HNM)	(16 A)	218 - 219
MIXO	(10 A/16 A)	271 - 306

* the underlined polarities indicate those contacts that require the tools shown in this page

pneumatic crimping tool positioner - gauge



insertion tool - removal tools replacement tip

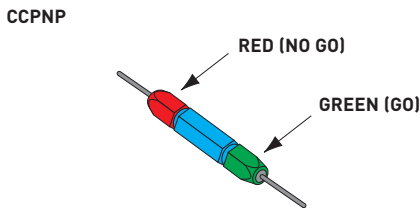


description	part No.	part No.
pneumatic crimping tool for 10 A and 16 A contacts model DANIELS WA27F (turret excluded)	CCPZP	
positioner (see note) for 10 A contacts (CD and RD HNM series) for 16 A contacts (CC and RC HNM series)	CCTP 10 CCTP 16	
bench support for CCPZP pneumatic crimping tool (DANIELS BM-2A)	CCSPZP	
pneumatic foot valve (DANIELS WA10A)	CCVPP	
"go / no go" control gauge to verify indenter closure (see note)	CCPNP	
insertion tool for insertion of the contacts into the inserts for crimped contacts up to 0,75 mm ²		CCINA
removal tools for the extraction of contacts from the inserts for 10 A contacts (CD and RD HNM series) ¹⁾ for 16 A contacts (CC and RC HNM series) ²⁾		CCES CQES
replacement tip for CCES removal tool		CCPR RN

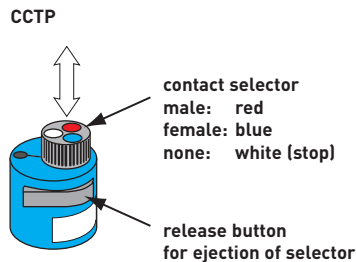
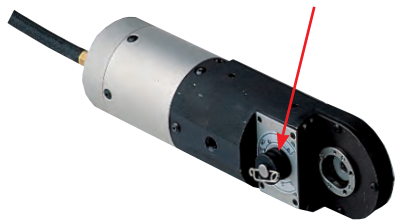
1) for CQ, CD, RD, CDD, RDD, CX, RX inserts (10 A auxiliary contacts) and MIXO module (10 A)
2) for CQ, CQE, CQEE, RQEE, CCE, RCE, CMCE inserts (excluded 16+2), MIXO module (16 A), CX 6/6 (16 A) and CDC. For CMCE (16+2), CX inserts (contacts 16 A insert CX 8/24) using a flat 3 mm screwdriver.

Notes:
Positioner
conforms to international standard MIL-C-22520/1
- An interchangeable and indispensable accessory of the CCPZP crimping tool, it precisely positions the contact where crimping is performed. Each series of contacts requires its own turret.

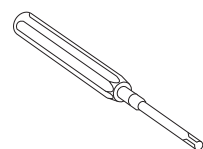
"go / no go" control gauge
conforms with international standard MIL-C-22520/3
- A tool used to periodically check that the crimping tool meets standard requirements.



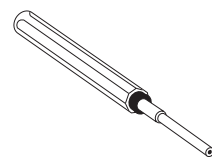
CCPZP crimping depth adjuster dial selector



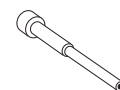
CCINA



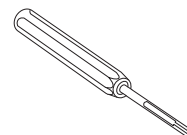
CCES



CCPR RN



CQES



Watch our online tutorial

Use and maintenance instructions

1. General specifications

This is the pneumatic version of the **DANIELS AF8 crimping tool** (CCPZ MIL). Crimping is performed with 8 pressure points.

The tool is equipped with a geared mechanism to control the complete crimping cycle.

The tool must be equipped with an interchangeable turret (CCTP) according to the series of contacts to be crimped.

It is possible to use a hand valve (located on the crimping tool) or a foot valve (optional). The tool operating pressure is 5,5 - 8,3 bar. It is recommended to utilise an adjustment and air filtering unit.

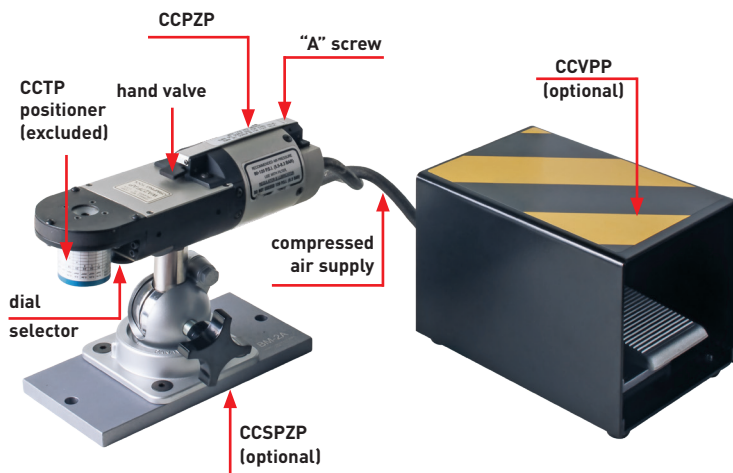
1.1 Crimping range

Conductor cross-sectional area range: from 0,14 mm² (26 AWG) to 4 mm² (12 AWG).

1.2 Operation with pneumatic foot valve (optional)

Connect the foot valve between the compressed air source and the tool air inlet.

Lower the hand valve on the tool and stop it in the lowered position with the stop screw (A) using a 1/16" Allen wrench.



2. Checking the crimping complete cycle control mechanism

Correct operation can be checked based on the following procedure:

- 1 Install a CCTP turret (see 3).
- 2 Reduce the pressure to 1 bar.
- 3 Using a contact that corresponds to the installed turret, with size 0,5, and a wire with section 0,5 mm², use the crimping tool, referring to the crimping instructions. The indenters will not reach the fully closed position and the contact will be internally blocked if the geared mechanism is operating correctly.
- 4 To release the partially crimped contact, increase the air pressure of the line to 5,5 - 8,3 bar and again use the crimping tool. It will then complete the crimping, allowing the indenters to return to the fully open position.

3. CCTP positioner installation (Fig. A)

- 1 Position the previously selected CCTP positioner on the support ring located on the crimping tool (matching the special pin on the base of the turret with the corresponding hole on the support ring), aligning the tapped holes with the socket head screws.
- 2 With the CCTP positioner positioned against the support ring, tighten the socket head screws with the 3,5 mm Allen wrench (supplied with the kit).
- 3 Refer to the data plate on the CCTP positioner. From the colour code column, select the colour of the positioner that corresponds to the appropriate code and dimension of the contact to be crimped.
- 4 With the CCTP positioner in the adjustment position, turn the turret selector until the colour-coded positioner is aligned with the indicator line. Press the turret until it clicks into the connected position.
- 5 Refer to the data plate on the CCTP positioner. From the column indicating the proper conductor section, determine the number that corresponds to the contact being used.
- 6 Remove the retaining hook from the crimping tool dial selector. Lift the dial selector and turn it until the selector number is aligned with the indicator (SEL.NO.). Replace the retaining hook (if necessary).

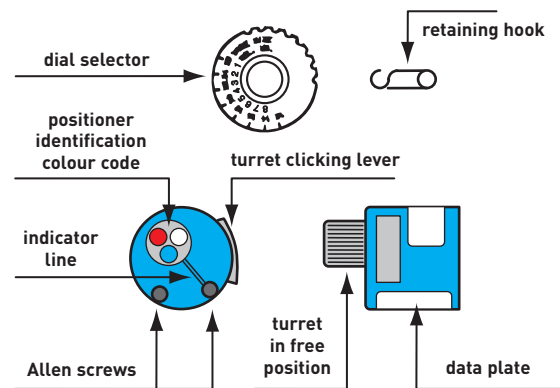


Fig. A

4. Crimping instructions

- 1 Insert the contact and the prepared conductor through the opening of the indenter in the turret positioner.
- 2 Activate the hand valve or the foot valve. Once crimping has been completed, the tool will return to the open position.
- 3 Check the position of the crimping on the contact crimping foot. Ideally, the crimping should be between the inspection hole and the top edge of the crimping foot. The head of the contact should not be squared and the inspection hole should be intact.

5. Releasing a partially crimped contact

To release a partially crimped contact, do the following:

- 1 Increase the air pressure to 8,3 bar and use the crimping tool. If the increase in air pressure does not release the contact, do the following.
- 2 Turn the dial selector clockwise to the highest lockable setting (the dial selector must be in the blocked position before continuing). Use the crimping tool.
- 3 If it does not release after several attempts, contact the ILME offices.

6. Removing the CCTP positioner

With the crimping tool in the open position, to disassemble the turret, loosen the socket head screws using the 3,5 mm Allen wrench (supplied with the kit). After the threads are released from the support ring, pull off the turret with a straight movement.

7. Instructions to check calibration

The operations to check the crimping tool must be carried out with the dial selector in position 4 and the CCPNP gauge.

ATTENTION! Do not crimp the gauge.

7.1 Calibration check

Put the crimping tool in the completely closed position.

“GO” - Insert the end (green) of the gauge as shown (Fig. 1).

The gauge must pass freely between the indenter tips.

“NO GO” - Insert the end (red) of the gauge as shown (Fig. 2).

The gauge should not pass through the opening.

Gauge	tool selector pos. No.	Ø A ± 0,00254 mm (GO) green	Ø B ± 0,00254 mm (NO GO) red
CCPNP	4	0,991 (mm) 0,0390 (in)	1,118 (mm) 0,0440 (in)

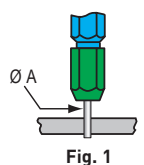


Fig. 1

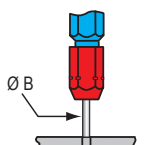


Fig. 2

8. Crimping tool maintenance

No maintenance is required.

However, it is good practice to keep the indenter tips free from residual deposits of the coloured band (some types of crimp contacts as per MIL standards are identified by coloured bands in the crimping area) and any other debris. A metal brush may be used for this purpose.

The following is strongly recommended:

- 1 DO NOT immerse the tools in a solution to clean them.
 - 2 DO NOT brush oil in the tools to lubricate them.
 - 3 DO NOT try to disassemble the tool or repair it.
- This is a high precision crimping tool and must be used as such.

Tools and accessories for crimp contacts

for contacts of inserts series (as applicable): page:

CD	(10 A)	66 - 74
CDD	(10 A)	76 - 83
CDC	(16 A)	104 - 106
CCE	(16 A)	130 - 135
CMCE	(16 A)	137 - 145
CQE	(16 A)	168 - 173
CQEE	(16 A)	176 - 177
CQ	(10 A/16 A)	186 - 193
CX 8/24	(16 A/10 A)	194
CX 6/36 *	(10 A)	198
CX 12/2 *	(10 A)	199
RX 12/2 * (HNM)	(10 A)	221
CX 6/6 *	(16 A)	206
RD (HNM)	(10 A)	208 - 209
RDD (HNM)	(10 A)	210 - 213
RCE (HNM)	(16 A)	214 - 217
RQEE (HNM)	(16 A)	218 - 219
MIXO	(10 A/16 A)	271 - 306

* the underlined polarities indicate those contacts that require the tools shown in this page

pneumatic crimping tool with automatic positioner inserts - gauge



insertion tool - removal tools replacement tip

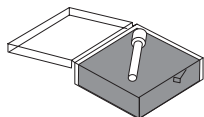


description	part No.	part No.
crimping tool with automatic positioner model DANIELS WA27FAP (inserts excluded)	CCPZPA	
positioner inserts (see note)		
male contacts 10 A (CDM and RDM HNM series)	CCTPADM	
female contacts 10 A (CDF and RDF HNM series)	CCTPADF	
male contacts 16 A (CCM and RCM HNM series)	CCTPACM	
female contacts 16 A (CCF and RCF HNM series)	CCTPACF	
"go / no go" control gauge to verify indenter closure (see note)	CCPNP	
insertion tool for insertion of the contacts into the inserts for crimped contacts up to 0,75 mm ²		CCINA
removal tools for the extraction of contacts from the inserts for 10 A contacts (CD and RD HNM series) ¹⁾ for 16 A contacts (CC and RC HNM series) ²⁾		CCES CQES
replacement tip for CCES removal tool		CCPR RN

- 1) for CQ, CD, RD, CDD, RDD, CX, RX inserts (10 A auxiliary contacts) and MIXO module (10 A)
- 2) for CQ, CQE, CQEE, RQEE, CCE, RCE, CMCE inserts (excluded 16+2), MIXO module (16 A), CX 6/6 (16 A) and CDC. For CMCE (16+2), CX inserts (contacts 16 A insert CX 8/24) using a flat 3 mm screwdriver.

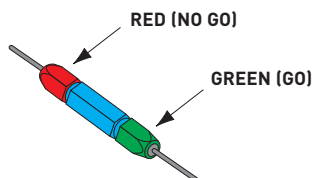
Notes:
Positioner inserts
 - Interchangeable and indispensable accessories of the CCPZPA crimping tool precisely position the contact where crimping is performed.
 Each contact requires its own positioner insert selected according to the type of contact (10 A or 16 A) and the kind (male or female).

CCTPADM and CCTPADF
CCTPACM and CCTPACF

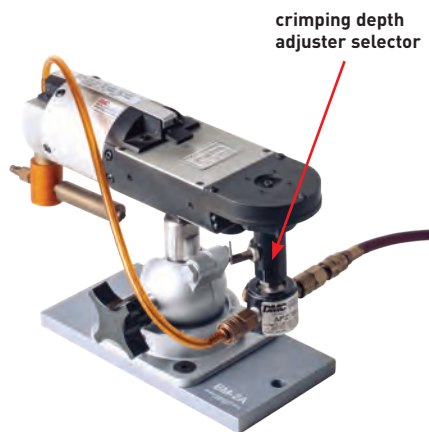


"go / no go" control gauge
 conforms with international standard MIL-C-22520/3
 - A tool used to periodically check that the crimping tool meets standard requirements.

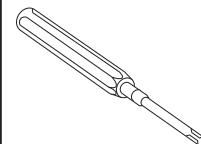
CCPNP



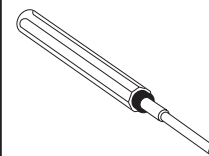
CCPZPA



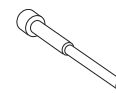
CCINA



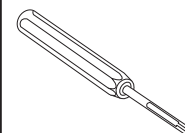
CCES



CCPR RN



CQES



Use and maintenance instructions

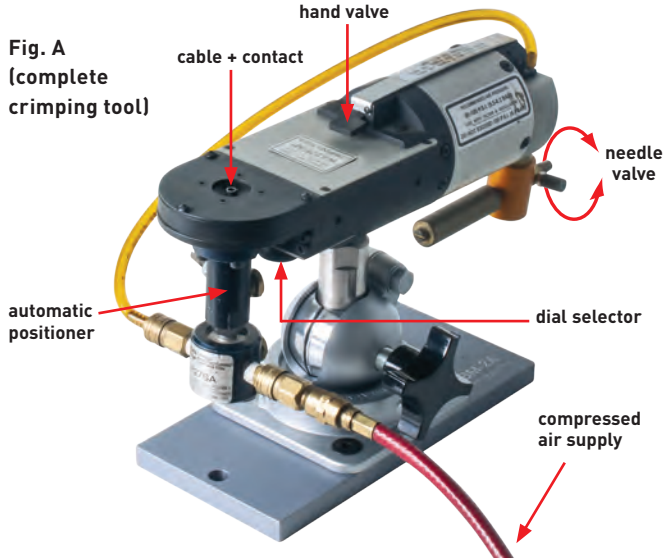
1. General specifications

This is the pneumatic version of the manual crimping tool. Crimping is performed with 8 pressure points. The tool is equipped with a geared mechanism to control the complete crimping cycle. Thanks to the automatic positioner it is possible to crimp simply by inserting the uncrimped contact + wire into the tool crimping cavity. **It is also necessary to order the interchangeable positioner inserts relative to the series of contacts to be crimped.**

The tool operating pressure is 5,5 - 8,3 bar. It is recommended to utilise an adjustment and air filtering unit.

1.1 Crimping range

Conductor cross-sectional area range: from 0,12 mm² (26 AWG) to 4 mm² (12 AWG).



2. Installation or replacement of a positioner insert

- 1 Disconnect the workshop compressed air source.
- 2 Disconnect the air hoses from the automatic positioner (rapid connectors).
- 3 Remove the connection screws, using the 3,5 mm Allen wrench (supplied with the kit), to separate the automatic positioner from the crimping tool. The indenters will not reach the fully closed position and the contact will be internally blocked if the geared mechanism is operating correctly.
- 4 Unscrew the positioner closing housing.
- 5 Install or replace the proper positioner insert in the positioner housing, replacing the underlying spring.
- 6 Reverse the operations, as described from point 4 to point 1.

3. Crimping position adjustment (Fig. B)

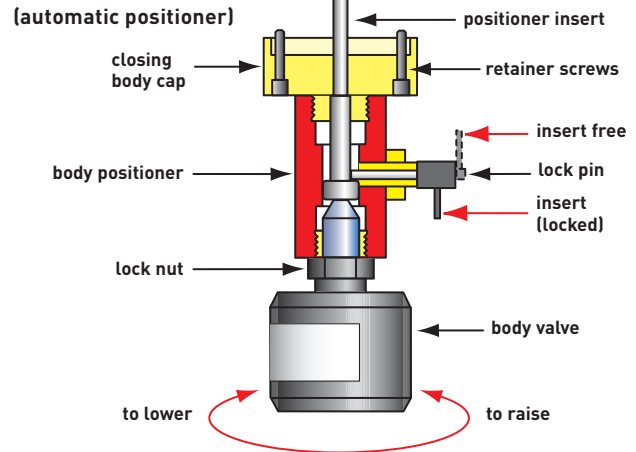
- 1 Release the automatic positioner from the crimping tool body (see points 1 and 2 "Installation replacement of a positioner insert").
- 2 While holding the body positioner in position using a 19 mm wrench, loosen the lock nut with a 14 mm wrench.
- 3 Push the positioner insert toward the bottom and lock it using the lock pin. The indenters will not reach the fully closed position and the contact will be internally blocked if the geared mechanism is operating correctly.
- 4 If the pin doesn't lock, unscrew the body valve toward the bottom.
- 5 With the pin locked, tighten the body valve toward the top until it strikes against the positioner insert.
- 6 While maintaining that position, tighten the lock nut.
- 7 Replace and connect the positioner on the crimping tool.
- 8 Release the lock pin in the "free" position.

4. Checking the crimping complete cycle control mechanism

Correct operation can be checked based on the following procedure:

- 1 Reduce the pressure to 1 bar.
- 2 Using a contact that corresponds to the installed positioner, with size 0,5 and a wire with section 0,5 mm², use the crimping tool, referring to the crimping instructions. The indenters will not reach the fully closed position and the contact will be internally blocked if the geared mechanism is operating correctly.
- 3 To release the partially crimped contact, increase the air pressure of the line to 5,5 - 8,3 bar and again use the crimping tool. It will then complete the crimping, allowing the indenters to return to the fully open position. The indenters will not reach the fully closed position and the contact will be internally blocked if the geared mechanism is operating correctly.

Fig. B



5. Crimping instructions

- 1 To obtain the suitable selector number, refer to the data plate located on the cover of the positioner insert case, and adjust the dial selector as specified.
- 2 Insert the contact and the prepared conductor through the opening of the indenter in the crimping tool casing (Fig. A).
- 3 Exert slight pressure until the crimping tool automatically crimps the contact. **CAUTION: Wire sections less than 0,34 mm² (24 AWG) up to 0,08 mm² (28 AWG) or equivalent are not sufficiently rigid, so that it may be rather difficult to push the contact + wire.**
- 4 Check the position of the crimping on the contact crimping foot. Ideally, the crimping should be between the inspection hole and the top edge of the crimping foot. The head of the contact should not be squared and the inspection hole should be intact.

6. Instructions to check calibration

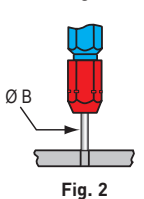
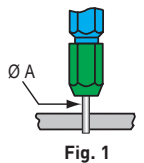
The operations to check the crimping tool must be carried out with the dial selector in position 4 and the CCPNP gauge.

ATTENTION! Do not crimp the gauge.

6.1 Calibration check

- 1 Disconnect the compressed air.
- 2 Push the positioner insert toward the bottom and lock it using the lock pin.
- 3 Reconnect the compressed air.
- 4 Turn the needle valve counterclockwise to open the air supply (Fig. A).
- 5 The indenters will extend and remain in the extracted position until the valve is closed.
- 6 Check using the gauge, referring to the "go / no go" instructions reported below.
- 7 When the calibration check has been completed, close the needle valve turning it clockwise (Fig. A).
- 8 Put the lock pin in the "free" position.
 - "GO" - Insert the end (green) of the gauge as shown (Fig. 1). The gauge must pass freely between the indenter tips.
 - "NO GO" - Insert the end (red) of the gauge as shown (Fig. 2). The gauge should not pass through the opening.

Gauge	tool selector pos. No.	Ø A ± 0,00254 mm (GO) green	Ø B ± 0,00254 mm (NO GO) red
CCPNP	4	0,991 (mm) 0,0390 (in)	1,118 (mm) 0,0440 (in)



7. Crimping tool maintenance

No maintenance is required. However, it is good practice to keep the indenter tips free from residual deposits of the coloured band (some types of crimp contacts as per MIL standards are identified by coloured bands in the crimping area) and any other debris. A metal brush may be used for this purpose. The following is strongly recommended:

1. DO NOT immerse the tools in a solution to clean them.
 2. DO NOT brush oil in the tools to lubricate them.
 3. DO NOT try to disassemble the tool or repair it.
- This is a high-precision crimping tool and must be used as such.

Tools and accessories for crimp contacts

for contacts of inserts series (as applicable): page:

CQ4 02	(40A)	182
CQ4 02 H	(40A)	183
CQ4 03	(40A)	184
CQ 04/2 *	(40A/10A)	191
CX 6/12 *	(40 A)	197
CX 6/36 *	(40 A)	198
CX 12/2 *	(40 A)	199
RX 12/2 * (HNM)	(40 A)	221
MIXO	(40 A)	267 - 272

* the underlined polarities indicate those contacts that require the tools shown in this page

pneumatic crimping tool positioner – gauge



CCSPZP

CCVPP

removal tool



description

part No.

part No.

pneumatic crimping tool for **40 A** contacts model DANIELS WA27-309-EP (bench support, positioner and control gauge are optional, pneumatic foot valve with 2,7 m air hose is supplied with tool)

CXPZP D

positioner (see note) for **40 A** contacts (**CX** and **RX HNM** series)

CXTP 40

bench support for CXPZP D pneumatic crimping tool (DANIELS BM-2A)

CCSPZP

"go / no go" control gauge (DANIELS G1005) to verify indenter closure or wear (see note)

CXPNPP

removal tool

for the extraction of contacts from the inserts for **40 A** contacts (**CX** and **RX HNM**) ¹⁾ and cables $\varnothing \leq 5$ mm for **40 A** contacts (**CX** and **RX HNM**) ²⁾ and cables $\varnothing \leq 7,5$ mm

CXES
CXES-10

- 1) for CX, RX inserts (40 A contacts) and MIXO module (40 A)
- 2) for MIXO module CX 03 4B and contacts 10 mm².

Notes:

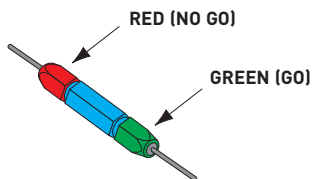
Positioner

- An interchangeable and indispensable accessory of the CXPZP D pneumatic crimping tool, it precisely positions the contact where crimping is performed.

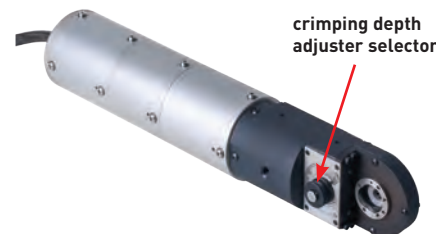
"go / no go" control gauge

- A tool used to periodically check that the crimping tool meets standard requirements.

CXPNPP



CXPZP D



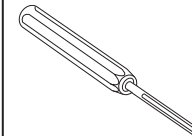
CXTP 40



CXTP 40

CONTACT	CX / RX	1.5	2.5	4.0	6.0	10
WIRE SIZE	mm ²	1,5	2,5	4	6	10
	AWG	16	14	12	10	8
SEL. NO.		5	5	5	7	8
USE WITH		M309 WA-27-309-EP				

CXES - CXES-10



Use and maintenance instructions

1. General specifications

This is the pneumatic version of the CXPZ D hand crimping tool (DANIELS M309). Crimping is performed with 8 pressure points. The tool is equipped with a geared mechanism to control the complete crimping cycle.

The tool must be equipped with the interchangeable positioner CXTP 40 suitable for series CX (or RX HNM version) crimp contacts.

The tool comes already equipped with a pneumatic foot pedal valve (WA10A) attached to the tool through 2,7 m (9 ft.) air hose.

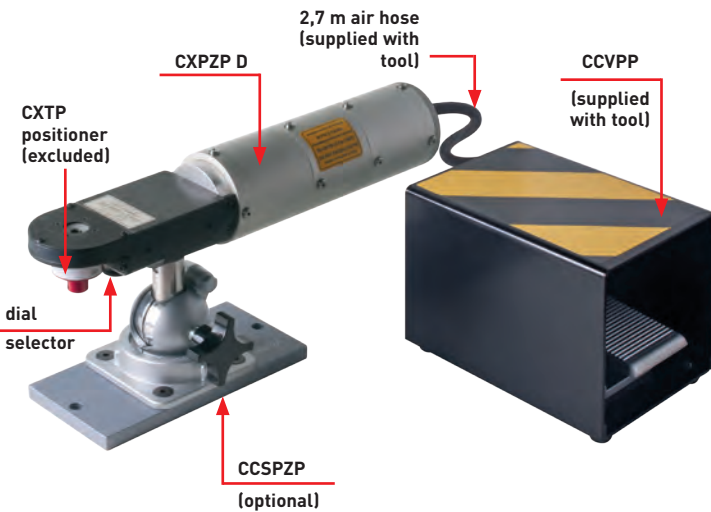
The tool operating pressure is 5,5 – 8,3 bar. It is recommended to utilise a lubrication, adjustment and air filtering unit.

1.1 Crimping range

Conductor cross-sectional area range: from 1,5 mm² (16 AWG) to 10 mm² (8 AWG).

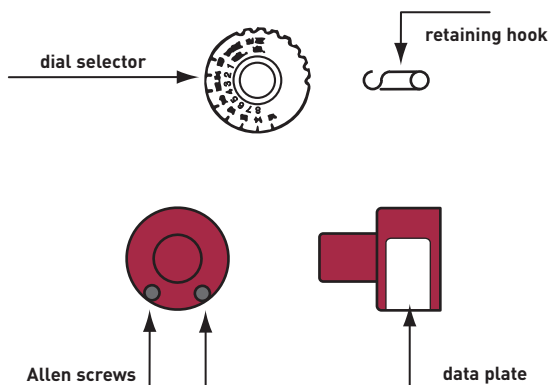
1.2 Operation with pneumatic foot valve (supplied with tool)

Connect the foot valve between the compressed air source and the tool air inlet.



2. CXTP 40 positioner installation

- Place the CXTP 40 positioner on the support ring located on the crimping tool (matching the special pin on the base of the turret with the corresponding hole on the support ring), aligning the tapped holes with the socket head screws.
- With the CXTP 40 positioner places against the support ring, tighten the socket head screws with the 3,5 mm Allen wrench (supplied with the kit).
- Refer to the dataplate on the CXTP 40 positioner. From the column indicating the proper conductor cross-sectional area, determine the number that corresponds to the contact being used.
- Remove the retaining hook from the crimping tool dial selector. Lift the dial selector and turn it until the selector number is aligned with the indicator (SEL.NO.). Replace the retaining hook (if necessary).



3. Checking the crimping complete cycle ratcheting control mechanism

Correct operation can be checked based on the following procedure:

- Install the CXTP 40 positioner (see 2).
- Reduce the pressure to 1 bar.
- Using a series CX contact that corresponds to the installed turret, e.g. size 1.5, and a wire with cross-sectional area 1.5 mm² (16 AWG) use the crimping tool, referring to the crimping instructions. The indenters will not reach the fully closed position and the contact will be internally blocked if the geared mechanism is operating correctly.
- To release the partially crimped contact, increase the air pressure of the line to 5,5 – 8,3 bar and again use the crimping tool. It will then complete the crimping, allowing the indenters to return to the fully open position.

4. Removing the CXTP 40 positioner

With the crimping tool in the open position, to disassemble the positioner, loosen the socket head screws using the 3,5 mm Allen wrench (supplied with the kit). After the threads are released from the support ring, pull off the positioner with a straight movement.

5. Releasing a partially crimped contact

To release a partially crimped contact, do the following:

- Increase the air pressure to 8,5 bar and use the crimping tool. If the increase in air pressure does not release the contact, do the following.
- Turn the dial selector clockwise to the highest lockable setting (the dial selector must be in the blocked position before continuing). Use the crimping tool.
- If it does not release after several attempts, contact the ILME offices.

6. Crimping instructions

- Insert the contact and the prepared conductor through the opening of the indenter in the turret positioner.
- Activate the hand valve or the foot valve. Once crimping has been completed, the tool will return to the open position.
- Check the position of the crimping on the contact crimping foot. Ideally, the crimping should be between the inspection hole and the top edge of the crimping foot. The head of the contact should not be squared and the inspection hole should be intact.

7. Instructions to check calibration

The operations to check the crimping tool must be carried out with the dial selector in **position 5** and the **CXPNPP** gauge (DANIELS G1005 – formerly G425, which is equivalent).

CAUTION! Do not crimp the gauge.

7.1 Calibration check

Put the crimping tool in the completely closed position.

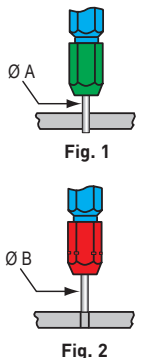
“GO” - Insert the end (green) of the gauge as shown (Fig. 1).

The gauge must pass freely between the indenter tips.

“NO GO” - Insert the end (red) of the gauge as shown (Fig. 2).

The gauge should not pass through the opening.

Gauge	tool selector pos. No.	Ø A ± 0,00254 mm (GO) green	Ø B ± 0,00254 mm (NO GO) red
CXPNPP	5	1,7526 (mm) 0,069 (in)	1,8796 (mm) 0,074 (in)



8. Crimping tool maintenance

No maintenance is required. However, it is good practice to keep the indenter tips free from residual deposits of the coloured band (some types of crimp contacts as per MIL standards are identified by coloured bands in the crimping area) and any other debris. A metal brush may be used for this purpose. The following is strongly recommended

- DO NOT immerse the tools in a solution to clean them.
- DO NOT brush oil in the tools to lubricate them.
- DO NOT try to disassemble the tool or repair it.

This is a high-precision crimping tool and must be used as such.

Tools and accessories for crimp contacts

for contacts of inserts series (as applicable): page:

CD	(10 A)	66 - 74
CDD	(10 A)	76 - 83
CDC	(16 A)	104 - 106
CCE	(16 A)	130 - 135
CMCE	(16 A)	137 - 145
CQE	(16 A)	168 - 173
CQEE	(16 A)	176 - 177
CQ	(10 A/16 A)	186 - 193
CX 8/24	(16 A/10 A)	194
CX 6/36 *	(10 A)	198
CX 12/2 *	(10 A)	199
RX 12/2 * (HNM)	(10 A)	221
CX 6/6 *	(16 A)	206
RD (HNM)	(10 A)	208 - 209
RDD (HNM)	(10 A)	210 - 213
RCE (HNM)	(16 A)	214 - 217
RQEE (HNM)	(16 A)	218 - 219
MIXO	(10 A/16 A)	271 - 306

* the underlined polarities indicate those contacts that require the tools shown in this page

stripping and crimping machine



insertion tool - removal tools replacement tip



description	part No.	part No.
automatic stripping, crimping machine Zoller+Fröhlich AM-03 Universal model	ZFU-CD	
insertion tool for insertion of the contacts into the inserts for crimped contacts up to 0,75 mm ²		CCINA
removal tools for the extraction of contacts from the inserts for 10A contacts (CD and RD HNM series) ¹⁾ for 16A contacts (CC and RC HNM series) ²⁾		CCES CQES
replacement tip for CCES removal tool		CCPR RN

1) for CQ, CD, RD, CDD, RDD, CX, RX inserts (10 A auxiliary contacts) and MIXO module (10 A)
2) for CQ, CQE, CQEE, RQEE, CCE, RCE, CMCE inserts (excluded 16+2), MIXO module (16 A), CX 6/6 (16 A) and CDC.
For CMCE (16+2), CX inserts (contacts 16 A insert CX 8/24) using a flat 3 mm screwdriver.

Technical specifications

Drive	electro-pneumatic
Electric feeder	230V/50Hz
Absorbed power	120VA
Fuse (on the system filter module)	2 x 2 A mT
Air operating pressure	5.5 bar
Air consumption	2 nl/cycle
Flexible conductors in conformity with	IEC 60228 class 5
Rated section	0,34-2,5 mm ² (22 AWG-14 AWG)
Feeding length	52 mm
Contacts	loose, turned
Contact breaker	see list of tools
Feeding	vibrating conveyor
Crimping form	4/8 ratchets
Cycle time	2,5 s - 3 s
Continuous sound level	< 70 dB (A)
Dimensions (l x d x h)	(530 x 500 x 480) mm
Colour	blue, RAL 5012
Weight	40 Kg

Tools list

contacts	CD, RD... (10A max)						CC, RC... (16A max)					
conductor section (mm ²)	0,34	0,5	0,75	1,0	1,5	2,5	0,5	0,75	1,0	1,5	2,5	
AWG (approximate)	22	20	18	18	16	14	20	18	18	16	14	
feeding bowl/male	A						B (M)					
feeding bowl/female							B (F)					
feeding tube	A						B					
wire holder	0,34	0,5-1,5				2,5	0,5-1,5 2,5					
starting unit	AB						AB					
stripping blades	V-shaped blades						V-shaped blades					
rear blade spacers												
left/right	0,5 mm / 1,0 mm						0,5 mm / 1,0 mm					
contact holder / pins	A (M)						B					
contact holder / bushes	A (F)											
contact stop	A						B					

Preset stripping and contact crimping programs

contacts	CD, RD... (10A max)						CC, RC... (16A max)					
conductor section (mm ²)	0,34	0,5	0,75	1,0	1,5	2,5	0,5	0,75	1,0	1,5	2,5	
AWG (approximate)	22	20	18	18	16	14	20	18	18	16	14	
Program number	1A	2A	3A	4A	5A	6A	7B	8B	9B	10B	11B	
stripping position (mm)	0,75	1,00	1,20	1,30	1,40	1,70	1,00	1,20	1,30	1,40	1,70	
crimping position	1,30	1,35	1,40	1,50	1,55	1,60	1,40	1,40	1,50	1,55	1,70	

Supplied with the following accessories:

- 1 vibrating conveyor feeder bowl for CD, RD contact series
- 1 vibrating conveyor feeder bowl for male CC, RC contact series
- 1 vibrating conveyor feeder bowl for female CC, RC contact series
- 1 feeder tube (contact passage from vibrating conveyor to machine) for CD, RD contact series
- 1 feeder tube (contact passage from vibrating conveyor to machine) for CC, RC contact series
- 1 contact holder (in crimping position) for male CD, RD contact series
- 1 contact holder (in crimping position) for female CD, RD contact series
- 1 contact holder (in crimping position) for CC, RC contact series
- 1 contact stop for CD, RD contact series
- 1 contact stop for CC, RC contact series
- 1 wire holder for 0,34 mm² cables
- 1 wire holder for 0,5 to 1,5 mm² cables
- 1 wire holder for 2,5 mm² cables
- 1 "GO / NO GO" control gauge
- 1 Allen wrench for setup operations
- 1 set of spacers to regulate the stripping length
- 1 removal tool to extract contacts from the crimping chamber

Use and maintenance instructions

General specifications

The **Zoller+Fröhlich AM-03** Universal stripping-crimping machine is a semi-automatic, electro-pneumatically operated bench machine used to quickly and reliably strip flexible copper wires and to crimp loose, turned crimp male and female, **CD, RD HNM** series (10 A max) and **CC, RC HNM** series (16 A max) contacts in a single run.

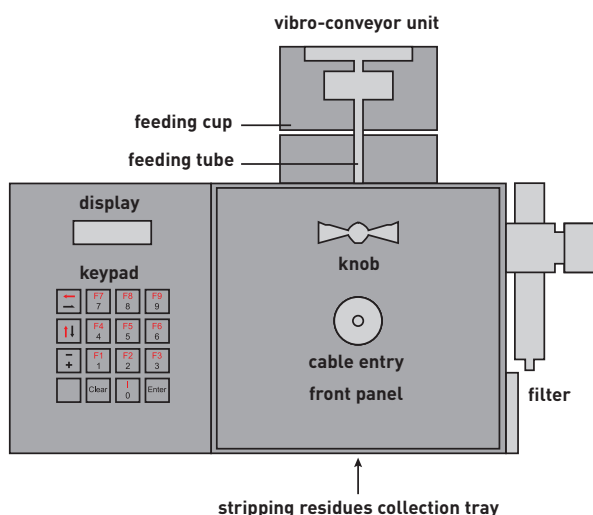
The contacts are automatically fed by means of a vibro-conveyor unit fitted on the top section of the machine.

The machine carries out the crimping operation with four, eight pressure point indenters, in compliance with the requirements set out in the MIL-C-22520/1 standard. The stripping depth and crimping depth adjustment is controlled by a software controlled motor. Up to 50 different combinations may be stored and retrieved from the program; these combinations are useful, for example, to meet different requirements related to the wire insulator type and thickness.

The adjustment and programming operations are carried out by using the keypad located on the front panel. The LCD display shows all the functions, the main information and any errors.

The machine is fitted with devices used to check that the crimping cycle has been completed.

The general safety instructions described in the machine user and maintenance manual must be followed and the use of the machine should only be restricted to qualified and trained personnel.



Crimping range

Wire section: from 0,34 mm² (AWG 26) to 2,5 mm² (AWG 14).

Description of the machine

To ensure a correct operation, the machine must be positioned on a hard bench, which does not amplify the effects of the internal movements occurring inside the machine. The machine consists of a vibrator which loads the contacts, of a tube which feeds the contacts and of a motorised wire stripping and contact crimping unit.

For each type and size of contact, the machine is provided with a factory stored preset program (see the machine user manual), which may be customised at any time.

The program allows the user to:

load, edit and save a program, as well as check/edit the stripping length and depth and the crimping depth.

Warning: when the machine is switched on, the working program is always the last program used.

The machine electronics adjustment is carried out by means of the keypad. Select one of the 12 programs (see table on page 728) according to the contact used*.

Each program stores the stripping and crimping depth.

The stripping depth is the measurement in mm of how much the stripping blades must penetrate the insulator to strip it off, and depends on the type of cable used. The crimping depth is the measurement in mm of how much the four indenters must penetrate the contact at the end of the crimping operation.

This depth depends on the size and shape of the contact (crimp shaft thickness) and determines the quality of the crimping operation in terms of gas tightness and resistance to tensile stress.

* **Note:** The machine also has a 12C program suitable for 10 A, 2,5 mm² crimp contacts with 6 mm stripping length. This program is therefore unsuitable for ILME CD, RD HNM series contacts (stripping length 8 mm).

Operational setups

The tool carrier carriage may be accessed by opening the front door, by anticlockwise rotation of the knob, which releases the pressure from all the valves. For tool selection, see table on page 728.

- For CD, RD HNM series male and female crimp contacts (10 A max), the feeding cup A must be fitted onto the machine, whilst for CC, RC HNM series crimp contacts (16 A max) feeding cup B (M) for male contacts and B (F) for female contacts must be used.
- The feeding tubes to be fitted are A for CD, RD HNM series contacts and B for CC, RC HNM series contacts respectively.
- The wire holders which support the wire during the stripping stage feature three different sizes for CD, RD HNM contacts and two sizes for CC, RC HNM contacts.
- The contact holders are two (A (M) for male contacts and A (F) for female contacts) for CD, RD HNM series contacts, according to the different rear diameter between male and female contacts in this series, whilst there is only one holder (B) for CC, RC HNM series contacts.
- The contact holder is A for CD, RD HNM series contacts and B for CC, RC HNM series contacts.

Feeding the wire

The wire must be cut straight and the single braids must not be bent or pulled apart; in particular, the first 4cm must be perfectly straight.

Checking the stripping depth:

The machine can be operated simply as a stripping machine by disabling the crimping operation.

Please refer to the machine user manual.

Maintenance and repairs

Stripping residues collection tray: empty the tray approximately every 2000 cycles (the frequency depends on the sizes of the stripped wire and on the stripping length). Pneumatically controlled maintenance unit: regularly drain any water that may have collected.

The trap may be cleaned with water.

To remove the trap, simply disconnect the air supply.

The filter unit may be unscrewed for cleaning purposes, then immersed in a cleaning agent (such as petrol or oil), thoroughly washed and dried.

Checking the calibration values

The correct calibration of the machine must be periodically checked by using the "GO / NO GO" caliper supplied as standard with the machine, by following the procedure described in the machine user and maintenance manual.

Tools and accessories for crimp contacts

for contacts series (as applicable):

page:

CX PLF/PLM
CX MLF/MLM

299
299

manual crimping tool

Front view



polishing disc, polish paper,
removal tool,
jacket stripper and fibre stripper,
cable cutter

CLES



description

part No.

part No.

crimping tool for POF **CX PL** and MOST **CX ML** contacts
RENNSTEIG model ¹⁾

CLPZ R

polishing disc (RATIOPLAST 910 PS 0SC 00 001)
for POF ²⁾ and MOST ³⁾ contacts

CLDL

polish paper:

grain size 1000 (RATIOPLAST 910 PB 001 00 001)
grain size 4000 (RATIOPLAST 910 PB 001 40 250)

CLC1

CLC4

removal tool

for the extraction of contacts from the CX L inserts

CLES

jacket stripper (RATIOPLAST 910 AZ 001 00 PA1)

for POF ²⁾ and MOST ³⁾ fibre optic with PA jacket

fibre stripper (RATIOPLAST 910 AB 001 00 001)

for POF ²⁾ fibre optic

CLSG

CLSP

cable cutter (RATIOPLAST 910 SW 001 00 001)

for Ø 2,3 mm max, for POF ²⁾ and MOST ³⁾ fibre optic

CLTE

¹⁾ on request tool **CLPZ** RATIOPLAST

910 CZ 001 00 008 for contacts POF ²⁾ / MOST ³⁾

crimping on the back

²⁾ **POF = POLYMER OPTICAL FIBRE**

³⁾ **MOST = MEDIA ORIENTED SYSTEM TRANSPORT**

Note:

as alternative to crimping please use glue UHU PLUS
ENDFEST 300 (BICOMPONENT), part No. "CL GL"
(provide a strain relief by cable glands):

- mix the two components on a sheet (just a drop/each)
- the stripped ca. 5 mm POF ²⁾ (that means the inner fibre) has to be dipped in the glue (just 5 mm);
- the POF ²⁾ has to be pushed now in the contact/ferrule;
- min. one night to hard/dry the glue;
- finally the POF ²⁾ has to be polished (polishing disc).

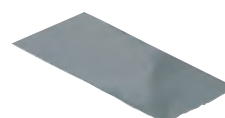
Rear view



CLDL



CLC1 / CLC4



CLSG



CLSP



CLTE



Use and maintenance instructions

General specifications

Strip the fibre about 12 mm for male contact and about 15 mm for female contact (see Figures 1 and 2).

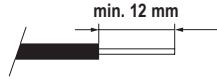


Fig. 1 - Example of cable stripping for male crimp contact

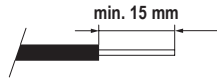
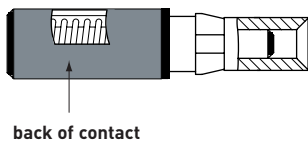


Fig. 2 - Example of cable stripping for female crimp contact

Crimping instructions

- The data sheet for crimping tool **CLPZ R** explains how the crimping tool works and how to adjust the crimping depth and locator for the contacts to be crimped. Position the turret on 3, push and turn of 90° the knob of turret. Adjust the crimping depth on 2 (unscrew the allen screw, after adjusting refix the screw). For the female contact: unscrew the back of the contact, pull out the internal central part; on Figure 3 is indicated the crimping area (front part of contact). For male contact: crimp the front part of contact.
- Push the stripped fibre as far as possible into the contact sleeve so that it protrudes approx. 1 mm from the tip of the contact.



back of contact

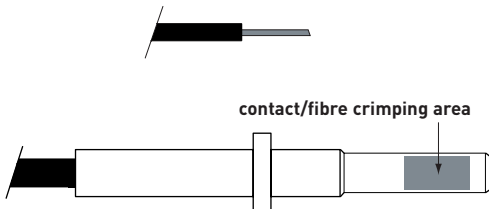


Fig. 3 - Female contact/fibre crimping area

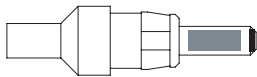


Fig. 4 - Male contact/fibre crimping area

- Insert the contact together with the fibre optic cable as far as possible into the crimping opening of the crimping tool (**CLPZ R**, see Figure 5) while applying gentle pressure to the fibre optic cable and connector, close the tool until you hear it disengages.

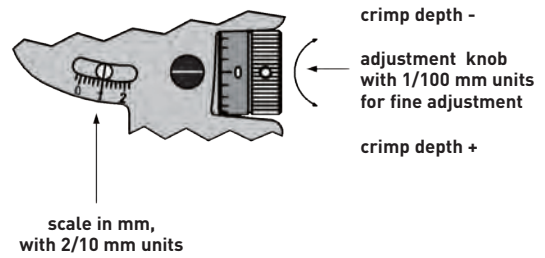
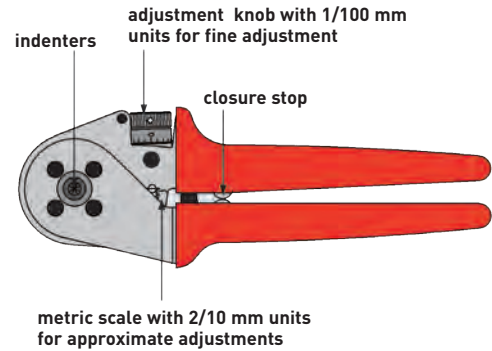


Fig. 5 - Manual crimping tool

Finishing the front surface

- Insert the contact into the polishing disc (**CLDL**) as shown in Figure 6. Work on a smooth surface (such as a sheet of glass), use grade 1000 polishing paper to grind off the protruding fibre and polish it with grade 4000 polishing paper.
- Wipe away any residue remaining after grinding. The best optical attenuation values are achieved when a wet grinding method is used.

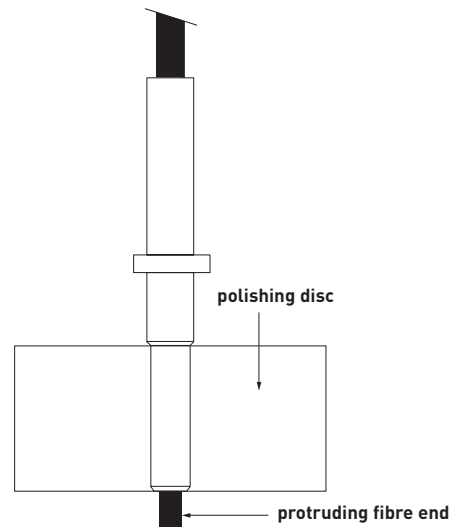


Fig. 6 - Polishing Disc with Guide for Connector Sleeve

Final mounting instructions

Screw the back female part contact. Put inside the CX 04 LF/ CX 04 LM insert.

Tools and accessories for crimp contacts

for contacts series (as applicable):

page:

manual crimping tool

polishing disc, polish paper,
removal tool,
jacket stripper and fibre stripper,
cable cutter

CLF DD/CLM DD

677

Front view



CCES



description

part No.

part No.

RENNSTEIG model crimping tool
for POF ¹⁾ CLF DD / CLM DD contacts

CLPZ R

polishing disc (RATIOPLAST 910 PS 0SC 00 001)
for POF ¹⁾ contacts

CLDL DD

polish paper:
grain size 1000 (RATIOPLAST 910 PB 001 00 001)
grain size 4000 (RATIOPLAST 910 PB 001 40 250)

CLC1
CLC4

removal tool, for the extraction of contacts from the
CD, CDD, CX inserts

CCES

jacket stripper (RATIOPLAST 910 AZ 001 00 PA1)
for POF ¹⁾ fibre optic with PA jacket
fibre stripper (RATIOPLAST 910 AB 001 00 001)
for POF ¹⁾ fibre optic

CLSG

CLSP

cable cutter (RATIOPLAST 910 SW 001 00 001)
for Ø 2,3 mm max, for POF ¹⁾ fibre optic

CLTE

¹⁾ POF = POLYMER OPTICAL FIBRE

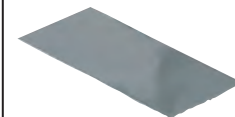
Rear view



CLDL DD



CLC1 / CLC4



CLSG



CLSP



CLTE



Use and maintenance instructions

Finishing the front surface of the fibre optic

- Before crimping, insert POF fibre optic into the polishing disc (CLDL DD) as shown in Fig. 1.
- Work on a smooth surface (such as a sheet of glass), use grade 1000 polishing paper to grind off the protruding fibre and polish it with grade 4000 polishing paper.
- Polish making 8-shape circles.
- Wipe away any residue remaining after grinding.

The best optical attenuation values are achieved when a wet grinding method is used.

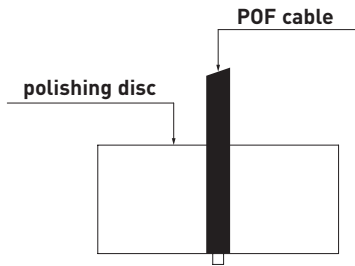


Fig. 1 - Polishing Disc with Guide for POF fibre

General specifications

Strip the fibre 19 mm for male contact and 14 mm for female contact (refer to Figures 2 and 3).

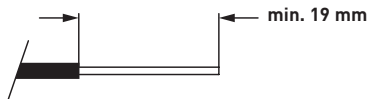


Fig. 2 - Example of cable stripping for male crimp contact

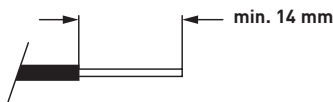


Fig. 3 - Example of cable stripping for female crimp contact

Crimping instructions

- The CLPZ R crimping tool data sheet explains how the crimping tool works and how to adjust the crimping depth and locator to crimp the contacts as shown in Fig. 4.
- Select position no. 1 on the turret (for male contact) and no. 2 (for female contact), push and turn of 90° the knob of the turret.
- Adjust the crimping depth on 1,45 (unscrew the allen screw, after adjusting refix the screw).
- Insert the contact together with the fibre optic cable as far as possible into the crimping opening of the crimping tool (CLPZ R, refer to Fig. 5) while applying gentle pressure to the fibre optic connector, close the tool until you hear it disengages.

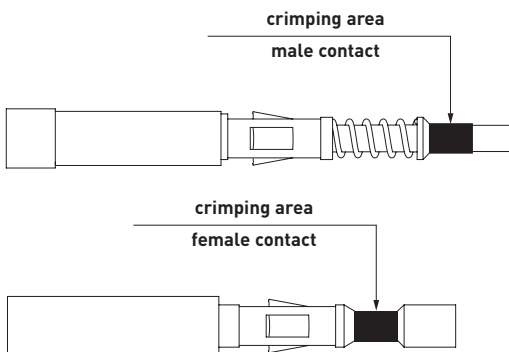


Fig. 4 - Crimping area

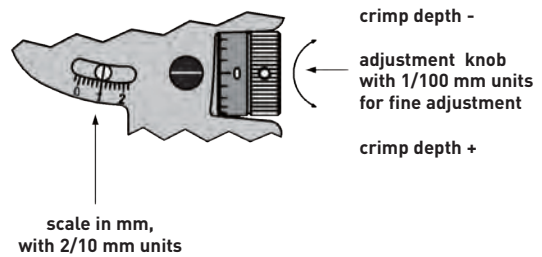
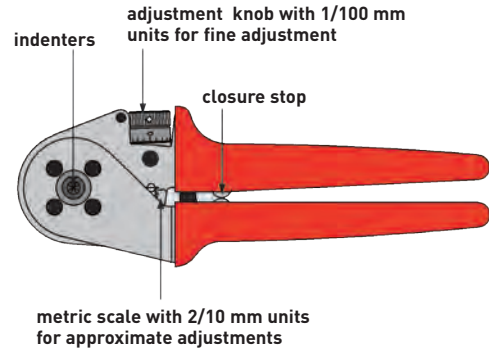


Fig. 5 - Manual crimping tool

Final mounting instructions

Screw the back female part contact. Put inside the CD/CDD/CX insert.



Watch our online tutorial

Tools and accessories for crimp contacts

for contacts series (as applicable):

CX 50 RF/M
CX 75 RF/M

page:

300
300

manual crimping tool



removal tool

coaxial cable stripper



description

part No.

part No.

crimping tool
for CX 50 RF/M and CX 75 RF/M coaxial contacts

COPZ

removal tool
for the extraction of contacts from the CX R inserts

CLES

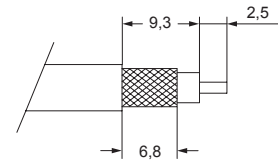
coaxial cable stripper
for the preparation of the cable according to the drawing

COST



Watch
our
online
tutorial

conductor stripping



coaxial contacts	for cables	ø external	part No.
50Ω	RG 316/U	2,49 ±0,1	CX 50 RF
	RG 174/U	2,79 ±0,127	CX 50 RM
	RG 188 A/U	2,79 max	
75Ω	RG 179 B/U	2,54 ±0,127	CX 75 RF
	RG 187 A/U	2,79 max	CX 75 RM
	TZC 75 101	2,79 max	

Crimping instructions

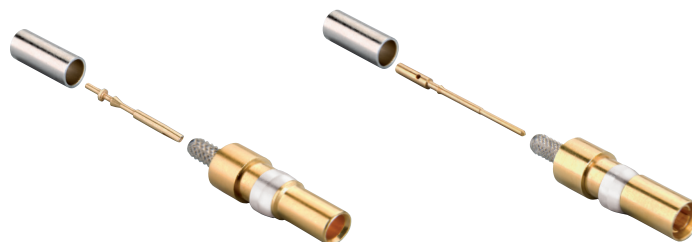
- 1) Strip the cable as per drawing using the tool COST.
- 2) Crimp the central contact of coaxial connector in the correct crimping area with the position 0,72 of crimping tool COPZ.
- 3) Insert the brass back end on the cable.
- 4) Insert the central contact in the coaxial connector, put the braid shield around the back cylinder of contact.
- 5) Insert the brass back end on the braid shield.
- 6) Crimp the ferrule with position 3,25 of crimping tool COPZ.

We recommend the use of coding pins CRF CX / CRM CX.

Fit the brass tube on the cable

As alternative to crimping, it is possible to solder the central contact.

CX 50 RF/M and CX 75 RF/M coaxial contacts



Tools and accessories for crimp contacts

for insert series (as applicable):

CJ (RJ45)
MIXO (RJ45)

page:

223
304 - 307

manual crimp pliers



shielded cable stripper



description	part No.	part No.
RJ45 CJ series plug insert crimp pliers basic tool YAMAICHI Y-ConTool-11 mod. with plug insert inserter	CJPZ Y	
Y-ConTool-20 cable stripper cuts the cable sheath and releases the wires in a single operation		CJST



Watch our CX 8 JM online tutorial

RJ45 plug insert crimp pliers mounting instructions

CRIMPING TOOLS

Tools and accessories for crimp contacts

inserts (as applicable):

MIXO (RJ45) CX 8 J6M

page:

302

manual crimp pliers



shielded cable stripper



description

part No.

part No.

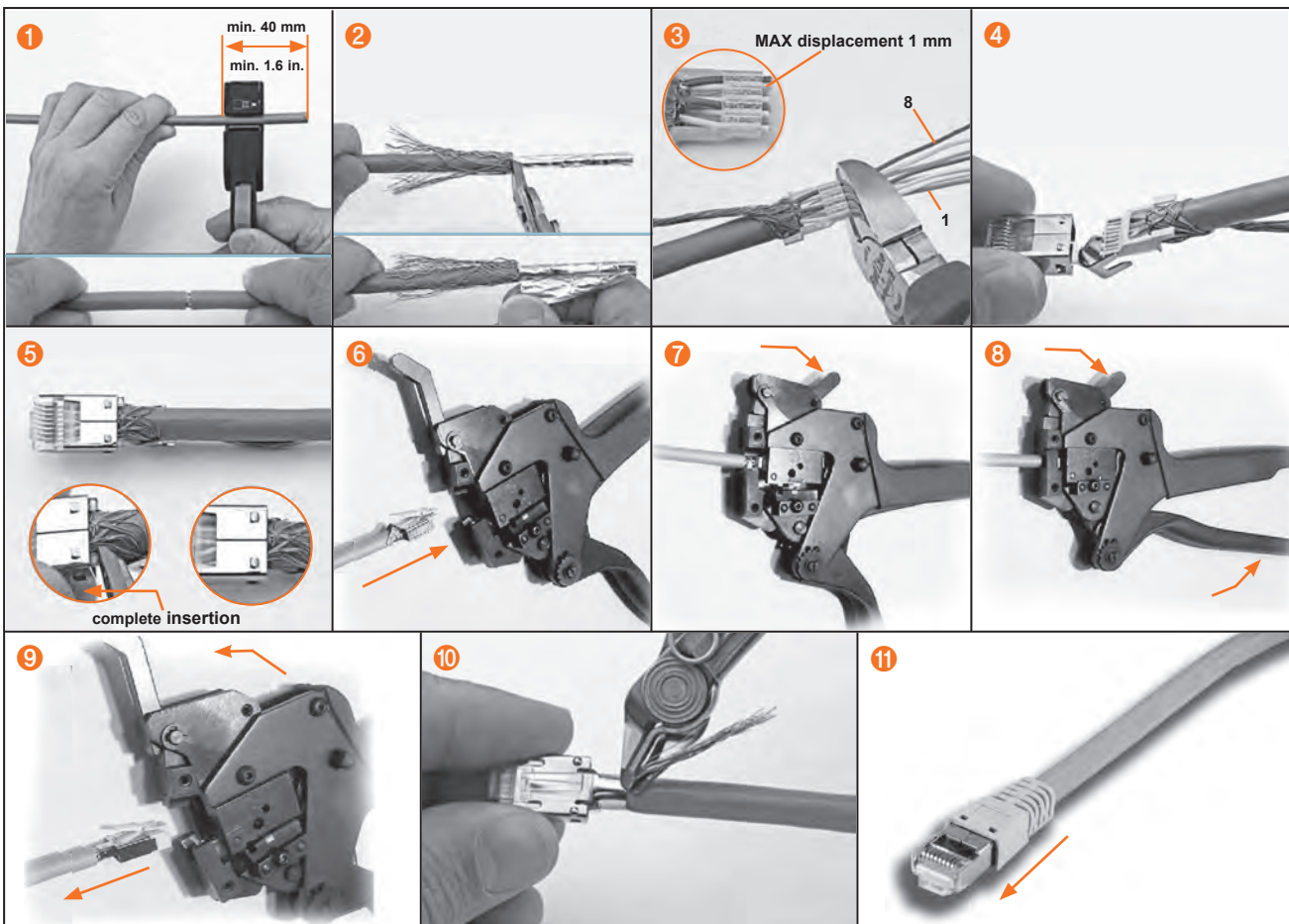
RJ45 CJ series plug insert crimp pliers

CJPZ T

Y-ConTool-20 cable stripper
cuts the cable sheath and
releases the wires in a single operation

CJST

RJ45 plug insert crimp pliers mounting instructions



CRIMPING TOOLS



Watch
our
online
tutorial

Tools and accessories for crimp contacts

inserts (as applicable):

MIXO (RJ45) CX 8 J6IM

page:

302

manual IDC pliers



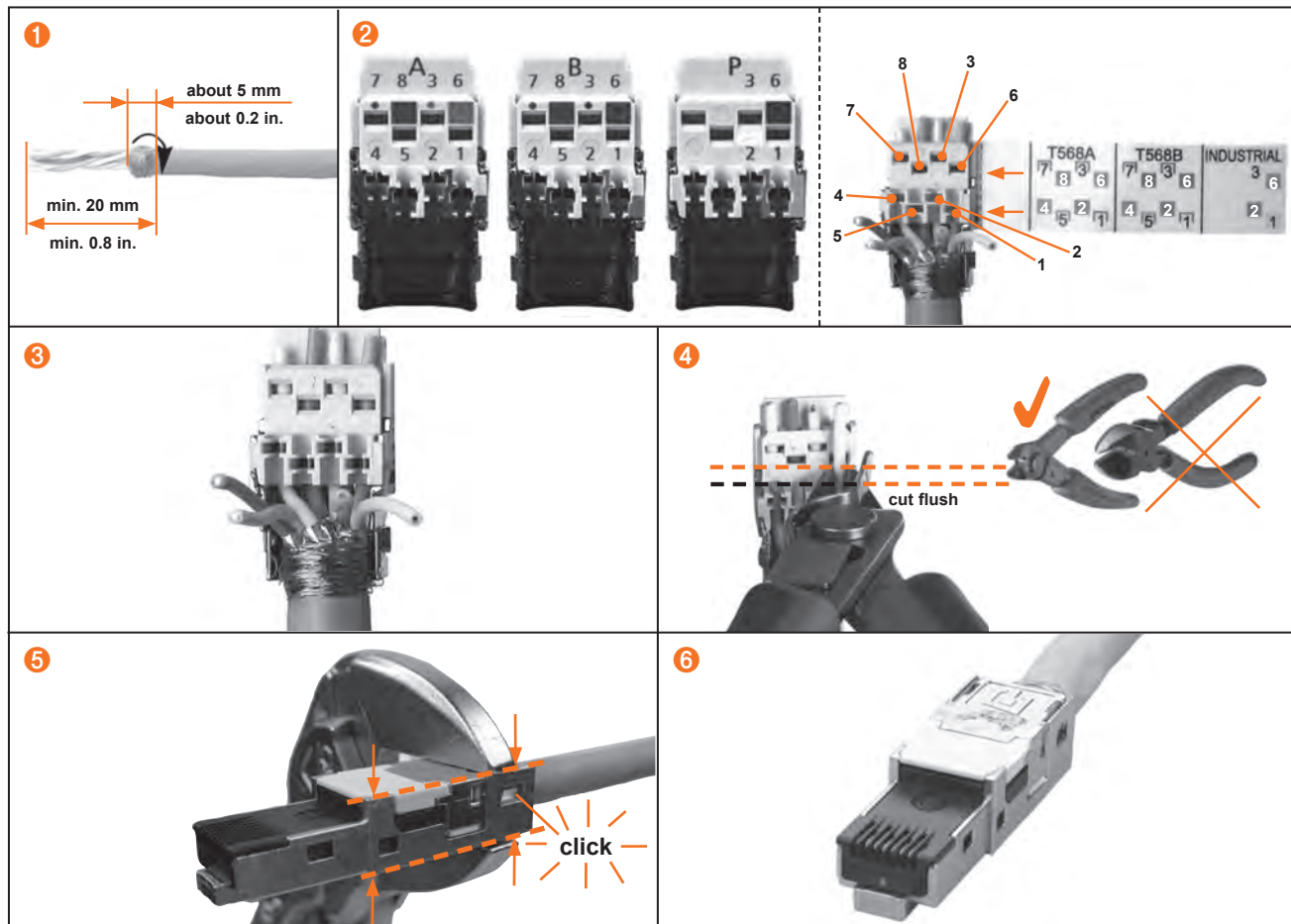
description

part No.

wrench pliers for CX 8 J6IM

CJPW K

CX 8 J6IM IDC plug insert crimp pliers mounting instructions



RJ45 PIN No.	Connection		Application					
	Colour Code A	Colour Code B	DIN 47100	Industrial PROFINET	10BT/100BT	1 Gigabit 10 Gigabit Ethernet	Token Ring ISDN/So	Upo/TEL
1	WH-GN	WH-OG	WH	YE	•	•		
2	GN	OG	BN	OG	•	•		
3	WH-OG	WH-GN	GN	WH	•	•	•	
4	BU	BU	YE	-		•	•	•
5	WH-BU	WH-BU	GY	-		•	•	•
6	OG	GN	PK	BU	•	•	•	
7	WH-BN	WH-BN	BU	-		•		
8	BN	BN	RD	-		•		

Legend

- BN = brown
- BU = blue
- GN = green
- GY = grey
- OG = orange
- PK = pink
- RD = red
- WH = white
- YE = yellow



Watch our online tutorial

for SQUICH® terminal

for insert series (as applicable):

page:

CDSH	86 - 91
CSAH	99 - 103
CSH	110 - 115
CSH S	122 - 127
CMSH	136 - 144

SQUICH® reopening tool



description

part No.

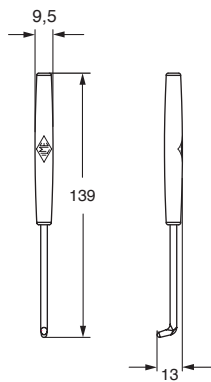
reopening tool
for SQUICH® actuator button

CSHES

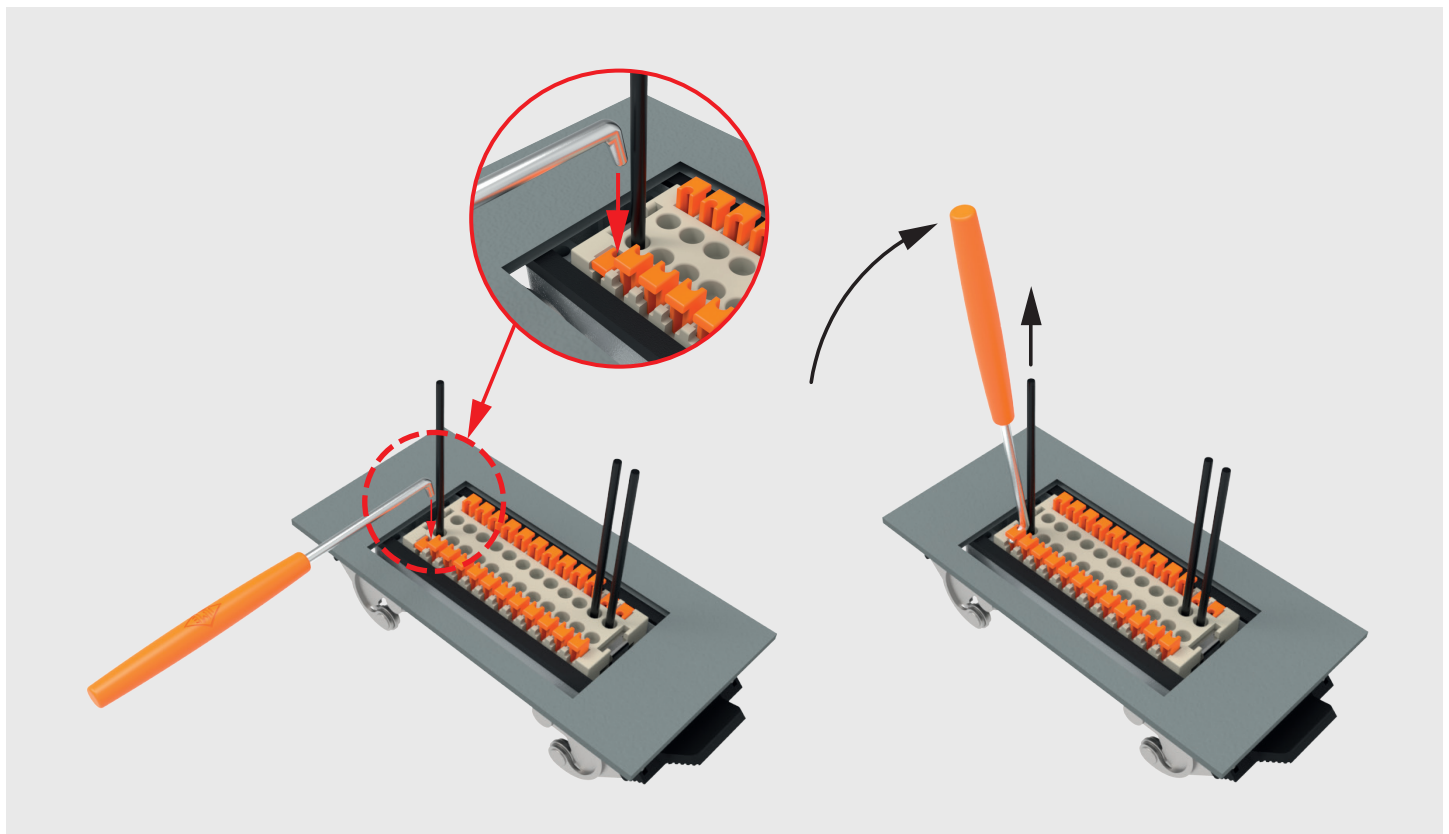
It allows the release of the connection from a SQUICH® terminal without disassembly of the connector insert from the bulkhead mounting housing, by operating from the accessible rear side of the control panel.

With mains power disconnected (connector not under voltage), the smoothed hook-shaped tool tip is inserted in the slot of the actuator button head of the corresponding terminal, then by a delicate tilt towards the centre of the connector, the tools acts as a lifting lever for the actuator button, releasing the wire.

CAUTION: Not suitable for SQUICH® terminals of CKSH inserts or MIXO CX 05 SH modular inserts.



Reopening tool use instructions

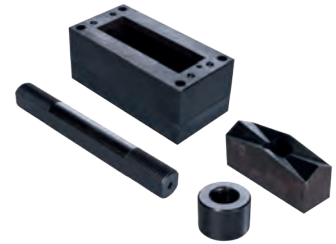


punching tool for bulkhead mounting housing

hydraulic panel punching tool



punching unit



description	part No.	part No.
hydraulic punching tool (without punching unit)	CCW CT	
punching unit for M25 hole ¹⁾		CCW M25
punching unit for M32 hole		CCW M32
punching units for panel cut-out of bulkhead mounting housings for size 21.21 CK/CKA for size 21.21 CGK IP68 for size 21.21 IVG for MIXO ONE for size 49.16 for size 66.16 for size 44.27 for size 57.27 for size 77.27 for size 104.27		CCW PD 03 CCW PD 03G CCW PD 03IVG CCW PD 1M CCW PD 15 CCW PD 25 CCW PD 06 CCW PD 10 CCW PD 16 CCW PD 24

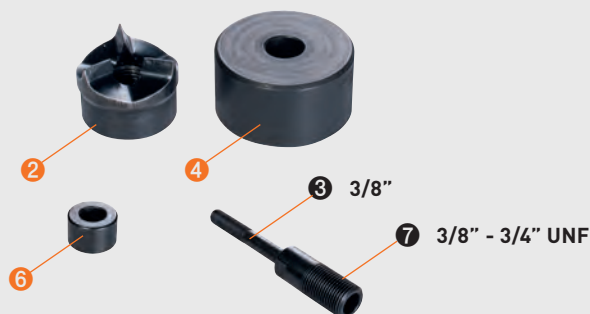
Punching unit	Bulkhead mounting housings Size	Pilot hole (mm)	Mounting configuration		Draw stud	Adapter	Spacer
			Hydraulic tool operation CCW CT	Manual operation			
CCW M25 ²⁾ dimensions \varnothing 25 mm	M25 hole or MKA IAF25 housings	\varnothing 10,0	with adapter and with spacer	---	CCW CT	CCW CT	CCW CT
CCW M32	M32 hole for MKA IF	\varnothing 20,0	with adapter and with spacer	---	CCW CT	CCW CT	CCW CT
CCW PD 03	21.21	\varnothing 14,5	with adapter and with spacer	with screw ball-bearing nut (no adaptor and no spacer)	CCW PD 03	CCW PD 03	CCW CT
CCW PD 03G	21.21 (CGK IP68)				CCW PD 03G	CCW PD 03G	CCW CT
CCW PD 03IVG	21.21 (IVG)	\varnothing 14,5	with adapter and with spacer	with screw ball-bearing nut (no adaptor and no spacer)	CCW PD 03IVG	CCW PD 03IVG	CCW CT
CCW PD 1M	MIXO ONE	\varnothing 14,5	without adapter and without spacer	with screw ball-bearing nut (no adaptor and no spacer)	CCW PD 1M	CCW PD 1M	CCW CT
CCW PD 15	49.16	\varnothing 20,4	without adapter and without spacer	---	CCW PD 15	NN	NN
CCW PD 25	66.16				CCW PD 25	NN	NN
CCW PD 06	44.27	\varnothing 25,4	without adapter and without spacer	---	CCW PD 06	NN	NN
CCW PD 10	57.27				CCW PD 10	NN	NN
CCW PD 16	77.27				CCW PD 16	NN	NN
CCW PD 24	104.27				CCW PD 24	NN	NN

²⁾ CCW M25 can be used to drill M25 pilot hole; NN = Not Needed

3, 6 and 7
delivered with CCW CT

LEGEND:

- 2** Punch ¹⁾
- 3** Draw stud 3/8"
- 4** Die
- 6** Spacer
- 7** Adapter 3/8" - 3/4" UNF



Use and maintenance instructions

Hydraulic operating instructions (CCW PD ..)

1. Screw the short thread of the 13,0/11,0 mm draw stud **3** into the $\frac{3}{4}$ " UNF adaptor **7** (CCW PD 03/03G only).
2. Screw the 13,0/11,0 mm draw stud **3** complete with the $\frac{3}{4}$ " UNF adaptor **7** onto the hydraulic cylinder or screw the short thread of any of the larger draw studs **3** (without the adaptor) directly onto the hydraulic cylinder (CCW PD 03/03G only).
3. Put the die **4** onto the draw stud **3** and move it towards the hydraulic cylinder. If necessary, place the spacer **6** between the hydraulic cylinder and die **4**.
4. Insert draw stud **3** with pre-mounted die through the pilot hole in the sheet until the die abuts the sheet.
5. Place the punch **2** onto the draw stud and move it towards the sheet until it abuts the sheet.
6. Screw the counter nut **1** onto the thread of the draw stud **3**.
7. Adjust punch rectangularly (4 marks on die) and tighten counter nut manually.

Punching

8. Operate hydraulic punch CCW CT driver until punch is drawn through sheet.
9. Depressurise hydraulic punch driver after punching.
10. Remove the counter nut **1** and punch **2** from the draw stud **3**.
11. Remove the die **4** from the draw stud **3** and remove slugs from the die **4**.

Drilling mounting holes

When punching, the position of mounting holes are marked. Use suitable spiral drill to drill mounting holes.

Manual operating instructions (CCW PD 03/..03G/..03IVG/ and ..1M)

Knockout punch mounting

1. Screw the ball-bearing nut **5** onto the long thread of the draw stud 13,0/11,0 mm **3**. Put the die **4** onto the draw stud **3** and move it towards the ball bearing nut **5**.
2. For further steps refer to hydraulic operating instructions steps 4 to 7.

Punching

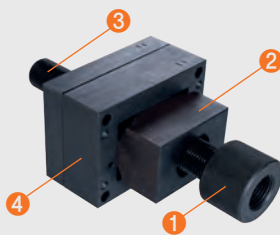
3. Use screw wrench SW 24 to rotate ball-bearing nut **5** until punch is drawn through sheet.
4. For further steps refer to hydraulic operating instructions steps 10 to 11.

Prior to commissioning please read operating instructions.

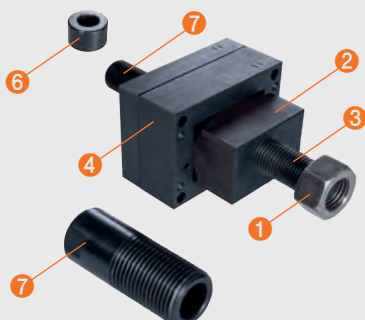
Components under voltage must not be machined.

Prior to operating ensure de-energised state of the work environment (e.g. switch cabinet) or the material to be machined.

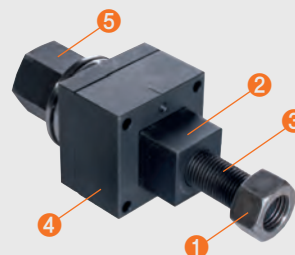
Hydraulic operating CCW PD.. (except CCW PD 03/ 03G)



Hydraulic operating (CCW PD 03G/..03IVG/..1M and CCW M32)



Manual operating (CCW PD 03/..03G/..03IVG/ and ..1M)



LEGEND:

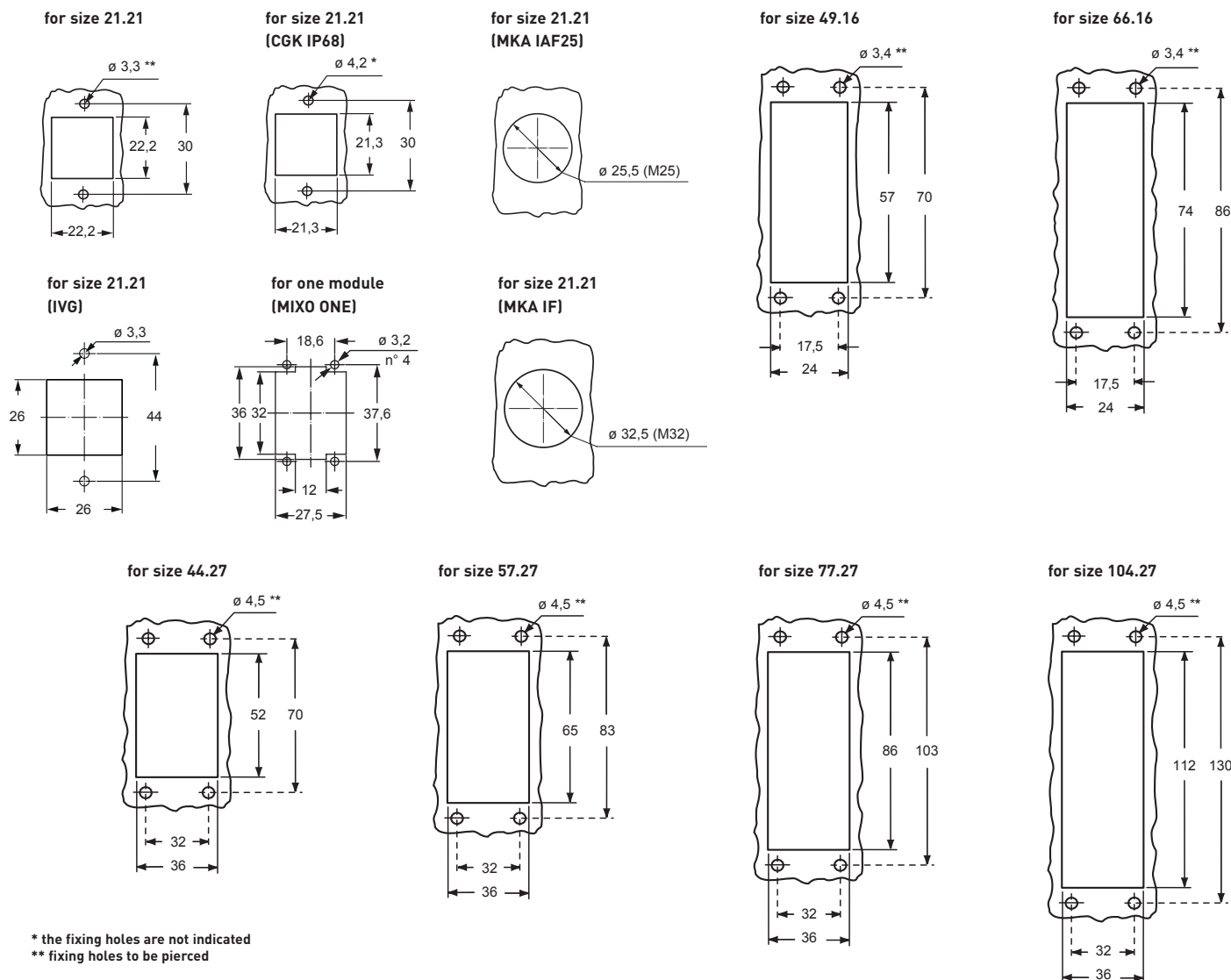
- 1** Counter nut
- 2** Punch
- 3** Draw stud
- 4** Die
- 5** Ball-bearing nut
- 6** Spacer
- 7** Adaptor

Use and maintenance instructions

ILME Product Number	Bulkhead mounting housings Size	Accessories	Draw stud ³⁾	Pilot hole	Sheet thickness	Manual screw-wrench use	Hydraulic use
CCW M25 (***)	M25 hole or MKA IAF25 housings	Punch and die 25,4 M25	3/8"	10,0 mm	St./Fe. 2 mm		● (**)
CCW M32	M32 hole for MKA IF	Punch and die 32,5 M32	13,0/11,0 mm	20,0 mm	St./Fe. 2 mm		●
Panel cut-out (mm)							
CCW PD 03	21.21	22,2 x 22,2	13,0/11,0 mm	14,5 mm	St./Fe. 2 mm	●	● (*)
CCW PD 03G	21.21 (CGK IP68)	21,3 x 21,3	13,0/11,0 mm	14,5 mm	St./Fe. 2 mm	●	● (*)
CCW PD 03IVG	21.21 (IVG)	26 x 26	13,0/11,0 mm	14,5 mm	St./Fe. 2 mm	●	● (*)
CCW PD 1M	MIXO ONE	32 x 27,5	13,0/11,0 mm	14,5 mm	St./Fe. 2 mm	●	●
CCW PD 15	49.16	24,0 x 57,0	19,0/14,0 mm	20,4 mm M20	St./Fe. 3 mm		●
CCW PD 25	66.16	24,0 x 73,0	19,0/14,0 mm	20,4 mm M20	St./Fe. 3 mm		●
CCW PD 06	44.27	36,0 x 52,0	25,0/21,0 mm	25,4 mm M25 ²⁾	St./Fe. 3 mm		●
CCW PD 10	57.27	36,0 x 65,0	25,0/21,0 mm	25,4 mm M25 ²⁾	St./Fe. 3 mm		●
CCW PD 16	77.27	36,0 x 86,0	25,0/21,0 mm	25,4 mm M25 ²⁾	St./Fe. 3 mm		●
CCW PD 24	104.27	36,0 x 112,0	25,0/21,0 mm	25,4 mm M25 ²⁾	St./Fe. 3 mm		●

(*) Adaptor (delivered with CCW PD 03/03G/IVG) and spacer (delivered with CCW CT) needed; (**) Adaptor M25 and spacer (delivered with CCW CT) needed; (***) CCW M25 can be used to drill M25 hole.

Panel cut-out dimensions (in mm)



* the fixing holes are not indicated
 ** fixing holes to be pierced

APPENDIX

DIMENSIONING OF CLEARANCES AND CREEPAGE DISTANCES	744
EU ENVIRONMENTAL LEGISLATION	750
FIRE PROTECTION STANDARDS FOR RAILWAY APPLICATIONS	751
STANDARDS AND CERTIFICATIONS	753
SPECIFICATIONS	753
ILME SMART CONFIGURATOR	754
INDEX OF PART NUMBERS	756

Dimensioning of clearances and creepage distances

European standard **EN 61984:2009** which incorporates without modification the corresponding international standard **IEC 61984 Ed. 2.0 (2008-10)** is the reference standard for safety requirements and the relevant tests for multipole connectors for industrial uses.

It is applicable to connectors with rated voltage values of over 50 V, and up to 1 000 V, and rated currents values of up to 125 A per pole, for which no dedicated standard exists, or to which the detail specifications or the manufacturer refer as regards the safety aspects. It can be used as a guide for connectors with rated current exceeding 125 A per pole and for those with a rated voltage up to 50 V (the latter excluded from the scope of the Low Voltage Directive 2014/35/EU).

The last edition of the EN 61984 standard also introduced the definition of **connector without breaking capacity (COC)** to better distinguish this category of products from **connectors with breaking capacity (CBC)**.

For the safety and performance requirements of connector terminals, which depend on the connection technology adopted, this standard integrally refers to the corresponding standards (EN IEC 60999 series for screw-type and screwless type terminals, EN IEC 60352 series for solderless connections and relevant terminations).

For determining the minimum clearances and creepage distances (i.e. distances through-air and along the insulating surface) for connectors, this standard now refers, without any modifications to standard **IEC 60664-1 Ed. 2.0 (2007-04)**¹⁾.

In the following, the method for determining the minimum insulation in connectors is illustrated with reference to the IEC 60664-1 standard. The rated characteristics of each ILME connector family are provided on pages 14-19. As already in the first edition, the following are now obsolete: the insulation group concept and the distinction of rated voltage values into DC and AC, voltage values 220 V and 380 V were adapted to standardised values 230 V and 400 V according to IEC 60038²⁾ and some concepts were taken from the regulations for LV electrical systems of the IEC 60364³⁾ series, such as:

- the **overvoltage category** (I, II, III, IV), according to the use of the equipment⁴⁾; this is correlated with the transient overvoltages taken as a basis for determining the rated impulse voltage;
- the **pollution degree** (1, 2, 3);
- the **material group** (I, II, III) classification of insulating materials according to their resistance to tracking;
- the **electric field condition** (*homogenous or inhomogeneous*).

a. Overvoltage categories (or impulse withstand category)

The overvoltage category of a circuit or of an electrical system is identified by a conventional numeral (from I to IV) based on the limitation or the control of the assumed transient overvoltage values obtained on a circuit or electrical system and depends on the means used to reduce the overvoltages.

Table F.1 provides the rated impulse voltage for equipment energised directly from the low voltage mains as a function of the rated voltage of the power supply system, of the relevant line-to-neutral voltage and of the overvoltage category.

TABLE F.1.

Rated impulse voltage for equipment powered directly from the low-voltage mains (IEC 60664-1 Ed. 2.0 2008-10)

Nominal voltage according to IEC 60038 (CENELEC HD 472 S1, CEI 8-6)		Voltage line to neutral derived from nominal voltages a.c. or d.c.	Rated impulse voltage ^{b)}			
			Overvoltage category			
V	V	≤ V	V			
Three-phase ^{a)}	Single phase		I	II	III	IV
		50	330	500	800	1500
		100	500	800	1500	2500
	120-240	150	800	1500	2500	4000
230/400 277/480		300	1500	2500	4000	6000
400/690		600	2500	4000	6000	8000
1000		1000	4000	6000	8000	12000

- The "T" symbol indicates a four-wire three phase distribution system (star distribution). The lower value is the voltage between phase and neutral (phase voltage), whereas the higher value is the voltage between the phases (mains voltage). Where only one value is indicated, it refers to three-wire, three-phase systems (delta distribution) and specifies the line-to-line value.
- Equipment with these rated impulse values can be used in installations in accordance with standard IEC 60364-4-443 (Italian standard CEI 64-8/4 Section 443, German DIN VDE 0100-443).

Industrial machinery and installations with fixed connection to the low voltage supply system, hence their relevant components including multipole connectors, constitute an example of equipment belonging to overvoltage category III.

Examples of general equipment that comes under overvoltage category II are household electrical appliances, portable tools and other household or similar equipment.

For distribution networks with rated voltage **230/400 V** (star distribution, neutral-earthed) and overvoltage category III (impulse withstand category III), the required rated impulse withstand voltage is **4 kV**.

For distribution networks with rated voltage **400 V** or **500 V** (star distribution without neutral or with unearthed neutral, or delta distribution unearthed or corner-earthed) and overvoltage category III (impulse withstand category III), the required rated impulse withstand voltage is **6 kV**.

b. Pollution degree

Pollution indicates the presence of any kind of foreign matter, whether solid, liquid or gaseous (ionised gas) that can result in a reduction of dielectric strength or surface resistivity of the insulation. The standard establishes four pollution degrees. The categories are identified by conventional numerals based on the quantity of polluting agents or on the frequency of the phenomenon which determines the reduction of the dielectric strength and/or of the surface resistivity.

Pollution degree 1

No pollution or only dry, non-conductive pollution. The pollution has no influence.

Pollution degree 2

Only non-conductive pollution occurs except that occasionally a temporary conductivity caused by condensation is to be expected.

1) Endorsed with modifications as European standard EN 60664-1:2007 and published by CENELEC member countries as a national standard: Italian standard CEI EN 60664-1:2008-04 (CEI 109-1), German standard DIN EN 60664-1:2008-01 (VDE 0110-1)

2) EN 60038:2011 (IEC 60038-2009, modified), Italian standard CEI EN 60038:2012-08 (CEI 8-6), German standard DIN EN 60038:2012-04 (VDE 0175-1)

3) Italian standard CEI 64-8, German standard DIN VDE 0100

4) EN 60664-1 clarifies that the term "overvoltage category" is synonymous with "impulse withstand category" used in Clause 443 of IEC 60364-4-44

Pollution degree 3

Conductive pollution occurs or dry non-conductive pollution occurs which becomes conductive due to condensation which is to be expected.

Pollution degree 4

Continuous conductivity occurs due to conductive dust, rain or other wet conditions.

Pollution degree 3 is typical of an industrial environment or similar, while pollution degree 2 is typical of a household or similar environment.

EN 61984 allows the dimensioning of creepage distances (insulating distances along the surfaces) of connectors installed in enclosures with degree of protection \geq IP54 for the pollution degree immediately below that of the application environment (e.g.: 2 instead of 3).

Abstract from EN 61984

6.19.2.1 For a connector with a degree of protection IP54 or higher according to IEC 60529, the insulating parts inside the enclosure may be dimensioned for a lower pollution degree.

This lower pollution degree also applies to mated connectors where the enclosure is ensured by the connector housing and which may only be disengaged for test and maintenance purposes.

One may therefore use connectors installed in housings or enclosures with a degree of protection \geq IP54, at the rated voltage suitable to pollution degree 2 in industrial applications with pollution degree 3, if, in compliance with EN 61984, the connector coupling is opened only occasionally for test and maintenance purposes. Even in the event of temporary or limited permanence in uncoupled state, a closing cover is recommended in order to guarantee at least the IP54 degree of protection.

However, this does not apply to connectors which remain uncoupled and exposed to an industrial atmosphere for an indefinite period.

It should also be noted that pollution might penetrate inside coupled connectors also from remote parts of the electrical system, e.g. through conduits providing cable entry to the connectors enclosure.

Moreover, connector enclosures are usually supplied without cable entry devices, to let the installer select the most suitable one for its end-use application. The IP degree of protection – or the Type rating according to North American standards – marked or assigned to the connector enclosures is guaranteed only for mated and locked connectors that employ cable entry devices with IP degree and/or Type rating equal or higher than those of the connector enclosures chosen, installed in a workmanlike manner.

Examples of application for the selection of pollution degree 2 for a connector.

- Connector on an electric motor controller, which is uncoupled only to replace a faulty motor, also in cases where pollution degree 3 is instead specified for the system.
- Connector on a machine built in modules, which is opened only for transport purposes and which is used only for faster installation and for safer putting into service. One must make sure that the connector has not been polluted during transport. To ensure this has not occurred, protective covers or adequate packing must be used.
- Connector inside a panel with degree of protection \geq IP54. In this case one may even avoid equipping the connector with an IP54 enclosure.

c. Material group

The insulating material influences the determination of the minimum creepage distance. It is characterised according to the damage it suffers from the concentrated release of energy during scintillations when a surface leakage current is interrupted due to the drying of the contaminated surface.

The CTI (comparative tracking index, index of resistance to surface currents, defined in EN IEC 60112) is assumed as index of the resistance to creep currents of the insulating materials in the presence of atmospheric contaminating agents.

The CTI constitutes the numerical value of the maximum voltage at which a material can resist against 50 drops of an electrolytic test solution without tracking failure, i.e. without failure of insulation due to a progressive formation of conductive paths on the surface and/or within the solid insulating material (causing permanent electric arc between the electrodes of the test equipment) due to the combined effect of electric stress and electrolytic contamination.

Solid insulating materials are classified into four groups:

group I	600 \leq CTI
group II	400 \leq CTI < 600
group IIIa	175 \leq CTI < 400
group IIIb	100 \leq CTI < 175

For the purpose of determining the minimum creepage distances, the values for groups IIIa / IIIb (Table F.2, IEC 60664-1) are identical.

The insulating materials used to manufacture the ILME multipole connectors belong to groups IIIa / IIIb.

d. Electric field conditions

Minimum clearance (shortest distance in air between two conductive parts) is determined by Table F.2 of IEC 60664-1, bearing in mind the following influencing factors:

- the rated impulse voltage;
- the electric field condition;
- the altitude: the values specified in Table 2 are valid up to 2 000 m; for higher altitudes, the corrective factors specified in Table F.8 of IEC 60664-1 shall be used;
- the micro-environment.

The shape and arrangement of the conductive parts influence homogeneity of the electric field, hence the clearance able to insulate live parts. Clearances of **case A (inhomogeneous field)** withstand the corresponding impulse voltage under all conditions: clearances not less than those specified in **Table F.2 – case A** can be used irrespective of the shape and arrangement of the conductive parts and without verification by an impulse test.

1. Determination of clearances

To determine minimum clearance, the following must be identified in accordance with IEC 60664-1 standard:

- a) the rated voltage of the power supply (usually 230/400 V thus a conventional voltage line-to-neutral of 300 V, in star distribution networks with earthed neutral, or 400 V for star networks without neutral, or with unearthed neutral, or in networks with secondary windings of the distribution transformer delta connected, unearthed or corner-earthed and, therefore, with conventional line voltage 600 V);
- b) the overvoltage category (usually III).
- c) The rated impulse voltage determined from Table B.2 of IEC 60664-1 (usually 4 kV or 6 kV).
- d) The electric field condition to which the parts through which the current flows shall be subjected (worst case = inhomogeneous field) and the pollution degree (usually 3).

EN 61984 requires that the **clearance** be dimensioned according to IEC 60664-1. For clearances up to 2 mm, typically for printed circuit board connectors, the reference standard may alternatively be IEC 60664-5, to be read in conjunction with IEC 60664-1. The minimum clearance (shortest distance in air between two conductive parts) is therefore given by Table F.2 of IEC 60664-1, according to the rated impulse voltage derived from Table B.2 of the same standard, which is part of Annex B (informative) **Nominal voltages of supply systems for different modes of overvoltage control**. This table is attributable in particular to devices that do not foresee upstream any overvoltage surge arrester; it represents, therefore the “worst case” and replaces Table 5 of the previous edition of EN 61984. The rated impulse voltage must be chosen based on the nominal supply voltage and the overvoltage category. The assignment of connectors to a particular overvoltage category (usually III) is performed according to the rules of IEC 60664-1.

Here below three important definitions from EN 61984 to consider regarding “voltage”:

rated voltage
value of voltage assigned by the manufacturer to the connector and to which the operating and performance characteristics are referred

NOTE – A connector may have more than one rated voltage value.

[IEC 60664-1:2007, definition 3.9, modified].

rated impulse voltage
impulse withstand voltage assigned by the manufacturer to the connector, characterizing the specified withstand capability of its insulation against transient overvoltages

[IEC 60664-1:2007, 3.9.2, modified].

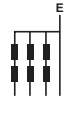



impulse withstand voltage
highest peak value of impulse voltage of prescribed form and polarity which does not cause insulation breakdown of insulation under specified conditions

NOTE – The impulse withstand voltage is equal to or higher than the rated impulse voltage

[IEC 60664-1:2007, 3.8.1, modified].

In regard to the choice of the electric field condition, the clearances through possible windows and openings in the insulating material housings, shall comply with the values of Case A of Table F.2 of IEC 60664-1, i.e. for inhomogeneous field conditions.

TABLE B.2
Inherent control or control of equivalent protection [IEC 60664-1 Ed.2.0 (2007-04)].

Voltage line-to-neutral derived from nominal voltages a.c. or d.c. up to and including ¹⁾	Nominal voltages presently used in the world				Rated impulse voltage for the device ¹⁾			
	Three-phase four wire systems	Three-phase three-wire systems	Single-phase two-wire systems	Single-phase three-wire systems				
	with earthed neutral 	earthed or unearthed 	a.c. or d.c. 	a.c. or d.c. 	Overvoltage category			
\underline{V}	\underline{V}	\underline{V}	\underline{V}	I				
50			12,5 24 25 30 42 48	30-60	330	500	800	1500
100	66/115	60	60		500	800	1500	2500
150	120/208 *) 127/220	115, 120, 127	100 **), 110, 120	100/- 200 *) 110-220 120-240	800	1500	2500	4000
300	220/380, 230/400, 240/415, 260/440, 277/480	200 **), 220, 230, 240, 260, 277	220	220-440	1500	2500	4000	6000
600	347/600 380/660 400/690 417/720 480/830	347, 380, 400, 415, 440, 480, 500, 577, 600	480	480-960	2500	4000	6000	8000
1000		660 690, 720 830/1000	1000		4000	6000	8000	12000

¹⁾ These columns are taken from Table F.1 indicating the te rated impulse withstand voltages.
*) Used in the United States and Canada.
)*) Used in Japan

With the three values (b) (c) and (d) the minimum clearance is determined in Table F.2 IEC 60664-1

TABLE F.2

Clearances to withstand transient overvoltages [IEC 60664-1 Ed. 2.0 (2007-04)].

Required impulse withstand voltage ^{1) 2)}	Minimum clearances in air up to 2.000 m. above sea level					
	Case A Inhomogeneous field (see 3.15) Pollution degree ⁶⁾			Case B Homogeneous field (see 3.14) Pollution degree ⁶⁾		
	1	2	3	1	2	3
kV	mm	mm	mm	mm	mm	mm
0,33 ²⁾	0,01	0,2 ^{3) 4)}	0,8 ⁴⁾	0,01	0,2 ^{3) 4)}	0,8 ⁴⁾
0,4	0,02			0,02		
0,50 ²⁾	0,04			0,04		
0,6	0,06			0,06		
0,80 ²⁾	0,1			0,1		
1	0,15			0,15		
1,2	0,25	0,25	0,2	0,3	0,3	
1,5 ²⁾	0,5	0,5	0,45	0,45		
2,5 ²⁾	1,5	1,5	1,5	0,6	0,6	
3	2	2	2	0,8	0,8	
4,0 ²⁾	3	3	3	1,2	1,2	1,2
5	4	4	4	1,5	1,5	1,5
6,0 ²⁾	5,5	5,5	5,5	2	2	2
8,0 ²⁾	8	8	8	3	3	3
10	11	11	11	3,5	3,5	3,5
12 ²⁾	14	14	14	4,5	4,5	4,5
15	18	18	18	5,5	5,5	5,5
20	25	25	25	8	8	8
25	33	33	33	10	10	10
30	40	40	40	12,5	12,5	12,5
40	60	60	60	17	17	17
50	75	75	75	22	22	22
60	90	90	90	27	27	27
80	130	130	130	35	35	35
100	170	170	170	45	45	45

1) This voltage is

- for functional insulation, the maximum impulse voltage expected to occur across the clearance (see 5.1.5),
- for basic insulation directly exposed or significantly influenced by transient overvoltages from the low-voltage mains (see 4.3.3.3, 4.3.3.4.1 and 5.1.6), the rated impulse voltage of the equipment,
- for other basic insulations (see 4.3.3.4.2), the highest impulse voltage that can occur in the circuit.

For reinforced insulation see 5.1.6.

2) Preferred values as specified in 4.2.3.

3) For printed wiring material, the values for pollution degree 1 apply except that the value shall not be less than 0,04 mm, as specified in Table F.4.

4) The minimum clearances given for pollution degrees 2 and 3 are based on the reduced withstand characteristics of the associated creepage distance under humidity conditions (see IEC 60664-5).

5) For parts or circuits within equipment subjected to impulse voltages according to 4.3.3.4.2, interpolation of values is allowed. However, standardization is achieved by using the preferred series of impulse voltage values in 4.2.3.

6) The dimensions for pollution degree 4 are as specified for pollution degree 3, except that the minimum clearance is 1,6 mm.

When the clearance is less than the value indicated for case A, an impulse voltage test is required.

Compared to the previous edition of IEC 60664-1, Table F.2 has been modified. In particular: the columns referring to pollution degree 4 have been removed, the definition of this pollution degree has been modified in 4.6.2 to: "continuous conductivity occurs due to conductive dust, rain or other wet conditions", and clearances for pollution degree 4 area as specified for degree of pollution 3, with the exception that the minimum clearance is 1,6 mm.

In 4.6.3 it states: "The dimensions for creepage distance cannot be specified where permanently conductive pollution is present (pollution degree 4). For temporarily conductive pollution (pollution degree 3), the surface of the insulation may be designed to avoid a continuous path of conductive pollution, e.g. by means of ribs and grooves (see 5.2.2.5 and 5.2.5)".

The values in bold are the most common in multipole connectors for industrial purposes.

If the component fulfils the minimum clearance prescribed for live parts at opposed polarities, it is exempted from the impulse withstand test. This test is run at sea level using increased voltage values in order to take into account rarefied air at high altitude (the prescribed values refer to 2 000 m a.s.l.). However, if this minimum clearance is not fulfilled, passing the test gives one the right to declare the relevant rated impulse voltage. Declaration of the rated impulse voltage is optional according to EN 61984: if the manufacturer declares the rated impulse voltage, the impulse withstand test is necessary as dielectric verification.

Alternatively, a dielectric voltage withstand test at mains frequencies of 50/60 Hz for 60 s (test 4a of IEC 60512) is necessary, but at reduced values compared to the peak values of the impulse test voltages of wave shape standardised at 1,2/50 μ s.

For this purpose, standard EN 61984 provides the following cross-reference table:

TABLE 8

Test voltages (EN 61984 Ed. 2.0 - 2009-06)

Rated impulse withstand voltage U_{ipm} kV	Test voltages		
	Impulse withstand voltage * kV (1,2/50 μ s)		Withstand voltage (r.m.s. value) kV (50/60 Hz)
	at 2000 above sea level	at sea level	
0,5	0,5	0,55	0,37
0,8	0,8	0,91	0,5
1,5	1,5	1,75	0,84
2,5	2,5	2,95	1,39
4	4	4,8	2,21
6	6	7,3	3,31
8	8	9,8	4,26
12	12	14,8	6,6

* If the test laboratory is situated between sea level and an altitude of 2 000 m a.s.l., interpolation of impulse withstand voltage is allowed.

NOTE: This table uses the characteristics of an inhomogeneous field, case A of IEC 60664-1 (worst case).

2. Determination of minimum creepage distance

For the **minimum creepage distance** (*shortest distance along the surface of a solid insulating material between two conductive parts*, IEC 60664-1 definition 3.3) IEC 61984 refers to what prescribed by IEC 60664-1 in **Table F.4**. It is determined according to: rated voltage, pollution degree and insulating material group.

The rated voltage providing access to **Table F.4** (rationalised voltage derived from the nominal voltages at which the connector is deemed to operate) is determined by **Table F.3a** of IEC 60664-1 for single-phase two or three-wire AC or DC systems or **Table F.3b** for three-phase three or four-wire AC systems.

TABLE F.3a

Single-phase two or three-wire AC or DC systems
(IEC 60664-1 Ed. 2.0 - 2007-04).

Rated supply voltage ¹⁾	Rationalised voltages for Table F.4	
	For insulation phase-phase ¹⁾	For insulation phase-phase ¹⁾
	All systems	Three-wire systems with intermediate earth point
V	V	V
12,5	12,5	-
24	25	-
25	25	-
30	32	-
42	50	-
48	50	-
50 **)	50	-
60	63	-
30-60	63	32
100 **)	100	-
110	125	-
120	125	-
150 **)	160	-
220	250	-
110-220	250	125
120-240	250	125
300 **)	320	-
220-440	500	250
600 **)	630	-
480-960	1000	500
1000 **)	1000	-

- 1) The line-to-earth insulation level for unearthed or impedance-earthed lines is equal to that between lines (phases), because the operating voltage of any line (phase) can, in practice, approach full voltage between lines (phases) [line voltage]. This is because the actual voltage to earth is determined by the insulation resistance and by the capacitive reactance of each line-to-earth. Consequently, a low (but acceptable) insulation resistance of a line can, in effect, earth it and increase voltage to earth of the other two phases at full voltage between the lines [line voltage].
- 2) For equipment for use on both three-phase three-wire and three-phase four-wire AC systems, earthed or unearthed, use only the values for three-wire systems.

*) It is assumed that the rated voltage of the equipment is not less than this value.

***) These values correspond to the values given in Table F.1.

Usually for three-phase systems with 230/400 V nominal voltage, the conventional line-to-line insulation voltage is 400 V and the line-to-earth for TT or TN systems is 250 V.

For three-phase systems with 400 V or 500 V nominal voltage, the conventional line-to-line insulation voltage is respectively 400 V and 500 V.

The pollution degree must be specified according to IEC 60664-1.

This strongly influences the **rated insulation voltage** of a connector. Therefore, the rated insulation voltage of a connector should be reconsidered time by time for each pollution degree.

TABLE F.3b

Three-phase four or three-wire AC systems
(IEC 60664-1 Ed. 2.0 - 2007-04).

Rated supply voltage ¹⁾	Rationalised voltages for Table F.4		
	For insulation phase-phase ¹⁾	For insulation phase-phase ¹⁾	
	All systems	Four-wire three-phase systems with earthed neutral	Four-wire three-phase systems unearthed ¹⁾ or with earthed phase
V	V	V	V
63	63	32	63
110	125	80	125
120	125	80	125
127	125	80	125
150 **)	160	-	160
208	200	125	200
220	250	160	250
230	250	160	250
240	250	160	250
300 **)	320	-	320
380	400	250	400
400	400	250	400
415	400	250	400
440	500	250	500
480	500	320	500
500	500	320	500
575	630	400	630
600 **)	630	-	630
660	630	400	630
690	630	400	630
720	800	500	800
830	800	500	800
960	1000	630	1000
1000 **)	1000	-	1000

With this rationalized voltage value, the pollution degree and the material group the minimum creepage distance can be determined using **Table F.4**.

TABLE F.4

 Creepage distances to avoid failure due to tracking
 [IEC 60664-1 Ed.2.0 (2007-04)].

Effective voltage ¹⁾	Minimum creepage distances								
	Materials for printed circuits			Pollution degree					
	1	2	1	2			3		
	All material groups	All material groups except IIIb	All material groups	Material group I	Material group II	Material group III	Material group I	Material group II	Material group III ²⁾
V	mm	mm	mm	mm	mm	mm	mm	mm	mm
10	0,0250	0,040	0,080	0,400	0,400	0,400	1,000	1,000	1,000
12.5	0,0250	0,040	0,090	0,420	0,420	0,420	1,050	1,050	1,050
16	0,0250	0,040	0,100	0,450	0,450	0,450	1,100	1,100	1,100
20	0,0250	0,040	0,110	0,480	0,480	0,480	1,200	1,200	1,200
25	0,0250	0,040	0,125	0,500	0,500	0,500	1,250	1,250	1,250
32	0,0250	0,040	0,14	0,53	0,53	0,53	1,30	1,30	1,30
40	0,0250	0,040	0,16	0,56	0,80	1,10	1,40	1,60	1,80
50	0,0250	0,040	0,18	0,60	0,85	1,20	1,50	1,70	1,90
63	0,0400	0,063	0,20	0,63	0,90	1,25	1,60	1,80	2,00
80	0,0630	0,100	0,22	0,67	0,95	1,30	1,70	1,90	2,10
100	0,1000	0,160	0,25	0,71	1,00	1,40	1,80	2,00	2,20
125	0,1600	0,250	0,28	0,75	1,05	1,50	1,90	2,10	2,40
160	0,2500	0,400	0,32	0,80	1,10	1,60	2,00	2,20	2,50
200	0,4000	0,630	0,42	1,00	1,40	2,00	2,50	2,80	3,20
250	0,5600	1,000	0,56	1,25	1,80	2,50	3,20	3,60	4,00
320	0,75	1,6	0,75	1,60	2,20	3,20	4,00	4,50	5,00
400	1,0	2,0	1,0	2,0	2,8	4,0	5,0	5,6	6,3
500	1,3	2,5	1,3	2,5	3,6	5,0	6,3	7,1	8,0 (7,9) ⁴⁾
630	1,8	3,2	1,8	3,2	4,5	6,3	8,0 (7,9) ⁴⁾	9,0 (8,4) ⁴⁾	10,0 (9,0) ⁴⁾
800	2,4	4,0	2,4	4,0	5,6	8,0	10,0 (9,0) ⁴⁾	11,0 (9,6) ⁴⁾	12,5 (10,2) ⁴⁾
1.000	3,2	5,0	3,2	5,0	7,1	10,0	12,5 (10,2) ⁴⁾	14,0 (11,2) ⁴⁾	16,0 (12,8) ⁴⁾
1.250			4,2	6,3	9,0	12,5	16,0 (12,8) ⁴⁾	18,0 (14,4) ⁴⁾	20,0 (16,0) ⁴⁾
1.600			5,6	8,0	11,0	16,0	20,0 (16,0) ⁴⁾	22,0 (17,6) ⁴⁾	25,0 (20,0) ⁴⁾
2.000			7,5	10,0	14,0	20,0	25,0 (20,0) ⁴⁾	28,0 (22,4) ⁴⁾	32,0 (25,6) ⁴⁾
2.500			10,0	12,5	18,0	25,0	32,0 (25,6) ⁴⁾	36,0 (28,8) ⁴⁾	40,0 (32,0) ⁴⁾
3.200			12,5	16,0	22,0	32,0	40,0 (32,0) ⁴⁾	45,0 (36,0) ⁴⁾	50,0 (40,0) ⁴⁾
4.000			16,0	20,0	28,0	40,0	50,0 (40,0) ⁴⁾	56,0 (44,8) ⁴⁾	63,0 (50,4) ⁴⁾
5.000			20,0	25,0	36,0	50,0	63,0 (50,4) ⁴⁾	90,0 (56,8) ⁴⁾	100,0 (64,0) ⁴⁾
6.300			25,0	32,0	45,0	63,0	80,0 (64,0) ⁴⁾	110,0 (72,0) ⁴⁾	125,0 (80,0) ⁴⁾
8.000			32,0	40,0	56,0	80,0	100,0 (80,0) ⁴⁾	140,0 (88,0) ⁴⁾	160,0 (100,0) ⁴⁾
10.000			40,0	50,0	71,0	100,0	125,0 (100,0) ⁴⁾	140,0 (112,0) ⁴⁾	160,0 (128,0) ⁴⁾
12.500			50,0 ³⁾	63,0 ³⁾	90,0 ³⁾	125,0 ³⁾			
16.000			63,0 ³⁾	80,0 ³⁾	110,0 ³⁾	160,0 ³⁾			
20.000			80,0 ³⁾	10,0 ³⁾	140,0 ³⁾	200,0 ³⁾			
25.000			10,0 ³⁾	125,0 ³⁾	180,0 ³⁾	250,0 ³⁾			
32.000			125,0 ³⁾	160,0 ³⁾	220,0 ³⁾	320,0 ³⁾			
40.000			160,0 ³⁾	200,0 ³⁾	280,0 ³⁾	400,0 ³⁾			
50.000			200,0 ³⁾	250,0 ³⁾	360,0 ³⁾	500,0 ³⁾			
63.000			250,0 ³⁾	320,0 ³⁾	450,0 ³⁾	600,0 ³⁾			

1) This voltage is

- for functional insulation, the working voltage,
- for basic and supplementary insulation of the circuit energized directly from the supply mains (see 4.3.2.2.1), the voltage rationalized through Table F.3a or Table F.3b, based on the rated voltage of the equipment, or the rated insulation voltage,
- for basic and supplementary insulation of systems, equipment and internal circuits not energized directly from the mains (see 4.3.2.2.2), the highest r.m.s. voltage which can occur in the system, equipment or internal circuit when supplied at rated voltage and under the most onerous combination of conditions of operation within equipment rating.

2) Material group IIIb is not recommended for application in pollution degree 3 above 630 V.

3) Provisional data based on extrapolation. Technical committees who have other information based on experience may use their dimensions.

4) The values given in brackets may be applied to reduce the creepage distance in case of using a rib (see 5.2.5).

NOTE – The high precision used in indicating creepage distances in this table does not mean that the uncertainty of measurement has to be of the same order of magnitude.

 In **boldface** the typical values for multipole rectangular connectors for industrial uses are shown.

EU environmental legislation

RoHS 2 (2011/65/EU) and WEEE 2 (2012/19/EU) Directives

The **RoHS 2 2011/65/EU Directive** (recast) replaced on 2013-01-03 the original RoHS 2002/95/EC Directive (with its later amendment 2008/35/EC).

This Directive introduced the ban of use of certain hazardous substances in new electrical and electronic equipment (end products) placed on the market from 1st of July 2006 (the exceptions for some applications were listed in Annex of the Directive and in a number of further Decisions of the EU Commission). Indirectly – in the supply chain – the ban also applied to the electrical components of said electrical and electronic equipment.

The banned and/or restricted substances originally were:

Lead (Pb) (0,1 %), **Mercury (Hg)** (0,1 %), **Cadmium (Cd)** (0,01 %), **Hexavalent Chromium (Cr⁶⁺)** (0,1 %), **Poly-brominated biphenyls (PBB)** (0,1 %) and **Poly-brominated diphenyl ethers (PBDE)** (0,1 %) (the latter two being families of flame retardants for thermoplastic materials)

to which the **Commission Delegated Directive 2015/863/EU** of 2015-03-31 added – with a period of grace of six and a half years – the following ones:

Bis(2-ethylhexyl) phthalate (DEHP) (0,1 %), **Butyl benzyl phthalate (BBP)** (0,1 %), **Dibutyl phthalate (DBP)** (0,1 %), **Diisobutyl phthalate (DIBP)** (0,1 %).

All ILME finished products (industrial electrical equipment) as well as all ILME components (for industrial electrical equipment) in the sense of the Directive are in conformity with the **RoHS 2 2011/65/EU Directive and all subsequent modifications** within the terms of its scope and the starting dates (transitional periods) established for each category of EEE (electrical and electronic equipment) covered in Annex I of said Directive.

For all components (connector inserts, removable crimp contacts, enclosures for connectors, and accessories related to connectors as far as they are in the scope) the products comply with the limit values for certain substances as set out in said RoHS 2 2011/65/EU Directive and all subsequent modifications, including the permitted exemptions of Annexes III and IV.

Conformity to Directive 2011/65/EU (RoHS II) is intended to the text of the Directive as amended by any applicable later Directive or Commission Delegated Directive associated to it and issued up to the date of this Catalogue (54 documents plus 2 Corrigenda) and to the extent described in the text of this Declaration, including these notes.

Depending on the product, it may make use of exemption 6(b) for lead as an alloying element in aluminium containing up to 0,4% lead by weight (enclosures for multi-pole electrical connectors declared to be made by aluminium die cast alloy, except IP68 series of sizes “44.27” through “104.27” and E-Xtreme® series, which do not use such exemption) or exemption 6(c) for copper alloy containing up to 4% lead by weight (multi-pole connector inserts and removable crimp contacts, except CSH S series, which does not use such exemption as it is not using machined contacts).

NOTE 1 – Expiration of exemption 6(b) has been deferred to 21st July 2021 for our category of products by Commission Delegated Directive (EU) 2018/740; expiration of exemption 6(c) has been deferred to 21st July 2021 for our category of products by Commission Delegated Directive (EU) 2018/741. The above expirations may be subject to further deferment, based on a public enquiry procedure deemed to start on 1st January 2021.

NOTE 2 – Such products by themselves – as components – are not covered by the RoHS 2 Directive; therefore, for such products, there are no direct legal requirements. As no EU Declaration of Conformity can be issued, the above does not constitute a EU Declaration of Conformity to the RoHS 2 2011/65/EU Directive, and the CE marking – which may be applied either on the part or on the packaging label in compliance with other applicable EU Directives, e.g. the Low Voltage Directive 2014/35/EU (a recasting of the previous directive 2006/95/EC in force from 2016-04-20) – is not referred to said RoHS 2 Directive.

The **WEEE 2 2012/19/EU Directive** (recast) replaced on 2014-02-15 the original WEEE 2002/96/EC Directive (and its later amendments 2003/108/EC and 2008/34/EC). Its last update is **Directive 2018/849/EU** of 2018-05-30. This Directive aims to recycle and minimise Waste from Electrical and Electronic Equipment (also referred to as WEEE). It encourages recycling, reuse and other forms of recovery of such technological waste and sets ambitious targets for recovery rate, variable depending on the product categories.

In the new Directive, a six-year **transitional period** was established up to 2018-08-14, during which the equipment included in its “open scope” still remained the same as per the former WEEE Directive. From 15th August 2018, the scope became “open”, subject to the exclusions for various categories of “equipment”, which include the **large-scale fixed installations**. *These are defined as “a large-size combination of several types of apparatus and, where applicable, other devices, which: (i) are assembled, installed and uninstalled by professionals; (ii) are intended to be used permanently as part of a building or a structure at a pre-defined and dedicated location; and (iii) can only be replaced by the same specifically designed equipment” and large-scale stationary industrial tools defined as “a large size assembly of machines, equipment, and/or components, functioning together for a specific application, permanently installed and uninstalled by professionals at a given place, and used and maintained by professionals in an industrial manufacturing facility or research and development facility”.*

Connectors and their accessories that, as components, **are outside the scope of RoHS 2 Directive, do not fall in the scope of WEEE 2** even once “open scope”; moreover, they are primarily used in installations of industrial automation (large-scale stationary industrial tools) which are exempted from conformity to the WEEE 2 Directive.

As required by the WEEE 2 Directive, ILME will take care of any technical and administrative obligation for any ILME product that might be involved.

As a manufacturer of electrical equipment and components for industrial use, ILME acknowledges the regulations introduced by these Directives. The above-mentioned Directives are already effective national law in all EU countries. Similar regional regulations aimed at the preservation of the environment are in force across the world outside Europe.

For the products described in this Catalogue, although the restrictions of use of the above mentioned hazardous substances are not legally applicable, in that no product in this Catalogue belongs to any of the product categories described and illustrated in the above mentioned RoHS 2 and WEEE 2 Directives, the **“RoHS conformity”** is important, as it is required downstream in the supply chain. ILME has therefore carried out the necessary corrective actions, which have led to the **“RoHS conformity”** of all products in this Catalogue, wherever required.

ILME products sold after 1st July 2006 do not contain any of the restricted substances in concentrations higher than those allowed by the RoHS 2 Directive and by the subsequent related Decisions taken by the EU Commission.

Fire protection standards for railway applications

The European standard EN 45545 governing fire protection on railway vehicles was published in 2013. In Italy, the various parts are:

- **UNI CEI EN 45545-1:2013-05** Railway applications – Fire protection on railway vehicles – Part 1: General;
- **UNI CEI EN 45545-2:2013-05** Railway applications – Fire protection on railway vehicles – Part 2: Requirements for fire behaviour of materials and components;
- **UNI CEI EN 45545-3:2013-05** Railway applications – Fire protection on railway vehicles – Part 3: Fire resistance requirements for fire barriers;
- **UNI CEI EN 45545-4:2013-05** Railway applications – Fire protection on railway vehicles – Part 4: Fire safety requirements for rolling stock design;
- **UNI CEI EN 45545-5:2013-05** Railway applications – Fire protection on railway vehicles – Part 5: Fire safety requirements for electrical equipment, including that of trolley buses, track guided buses and magnetic levitation vehicles;
- **UNI CEI EN 45545-6:2013-05** Railway applications – Fire protection on railway vehicles – Part 6: Fire control and management systems;
- **UNI CEI EN 45545-7:2013-05** Railway applications – Fire protection on railway vehicles – Part 7: Fire safety requirements for flammable liquid and flammable gas installations.

The standard replaces the previous voluntary Technical Specification CEN/TS 45545:2009 and has formalised the withdrawal of all conflicting national standards as of 1st April 2016, the date on which the following parallel standards cease to be effective: in Italy **UNI CEI 11170-1:2005**, **UNI CEI 11170-2:2005** and **UNI CEI 11170-3:2005**; in France, **NF F 16-101:1988** and **NF F 16-102:1992**; in Germany, **DIN 5510-2:2009**; in United Kingdom, **BS 6853:1999**. These, however, remained applicable until 31st march 2016. All certificates covering materials issued in line with national standards remained valid in Europe up until this date. As of 1st April 2016, the only reference standard is EN 45545:2013. However, due to the huge number of customer specifications and technical documents making reference to obsolete standards, the railway business is still moving to a complete unification to the EN 45545 series.

EN 45545-2 specifies the requirements for the fire behaviour of materials and components of railway vehicles according to the different hazard levels defined by EN 45545-1:2013 (**HL** = Hazard Level). See Table 1 – Classification of hazard levels (EN 45545-2:2013).

Table 1 – Hazard level classification (EN 45545-2:2013)

Operation Category (#)	Design Category			
	A: Vehicles forming part of an automatic train having no emergency trained staff on board	D: Double decked vehicles	S: Sleeping and couchette vehicles	N: All other vehicles (standard vehicles)
OC 1	HL1	HL1	HL2	HL1
OC 2	HL2	HL2	HL2	HL2
OC 3	HL2	HL2	HL3	HL2
OC 4	HL3	HL3	HL3	HL3

(#) Relationship between the service, the infrastructure and the conditions for the evacuation of passengers and staff

Each hazard level provides for its own specific test procedures, test conditions, fire protection requirements and severity (min or max threshold), ranging from **R1** to **R26**. Electrical components of small size and mass, such as electrical connectors, shall have a nominal fire behaviour rating (self-extinguishing) **94V-0 (standard UL 94)**.

The thermoplastic insulating material used in ILME connectors complies with the requirements of UL 94V-0. There are no requirements applicable to products with a combustible mass < 10 g not in contact with other unclassified products, if they are installed adjacent to components for which no certificates are available. In this case, the requirements depend on the so-called grouping rules.

Connectors are unlisted products in Table 2 of EN 45545-2:2013. As non-listed products, they must satisfy the requirements of Table 3, and as their exposed surface area is $\leq 0,2 \text{ m}^2$, the set of requirements for indoor location in a railway vehicle is R22 while for outdoor location it is R23 (Table 5 of EN 45545-2:2013).

For the materials of connectors, these are the sets of maximum applicable requirements. These sets establish parameters, procedures and limit thresholds (min or max) for the tests. In particular, R22 and R23 specify tests and limit values for **oxygen content** (oxygen index OI), **smoke density** (Ds max) and **toxicity** (conventional toxicity index CIT_{NLP}).

The polycarbonate used by ILME in its connectors meets the limit values specified in EN 45545-2.

See Table 2 – Requirements for unlisted products (including electrical connectors) – at following page.

Until the publication of the previously mentioned series of European standards, the most advanced fire safety standards for the railway industry were French:

- **NF F 16-101** Matériel roulant ferroviaire – Comportement au feu – Choix des matériaux;
- **NF F 16-102** Matériel roulant ferroviaire – Comportement au feu – Choix des équipements électriques;

which in turn referred to the test methods described in standards:

- **NF X 70 100** Analyse de gaz de pyrolyse et de combustion;
- **NF X 10 702** Détermination de l'opacité des fumées en atmosphère renouvelée.

Table 2 – Requirements for unlisted products (including electrical connectors)

Test method	Standard	Parameter	Unit	Interior	Exterior	R22 thresholds (more severe than R23)			ILME (polycarbonate)
Oxygen index OI	EN ISO 4589-2	OI (min)	%	R22	R23	HL1: 28	HL2: 28	HL3: 32	better than R22-HL3
Smoke density	EN ISO 5659-2	D _s max ¹⁾	---	R22	R23	HL1: 600	HL2: 300	HL3: 150	better than R22-HL3
Toxicity of smoke	NF X70-100-1 NF X70-100-2	CIT _{NLP} (max) ²⁾	---	R22	R23	HL1: 1,2	HL2: 0,9	HL3: 0,75	better than R22-HL3
¹⁾ D _s max = maximum specific optical density of smoke ²⁾ CIT _{NLP} (max) = maximum conventional index of toxicity of smoke									

These latter were somewhat similar, in terms of methods, to the American standards:

- **ASTM E 662** Standard Test Method for Specific Optical Density of Smoke Generated by Solid Materials;
- **ASTM E 162** Standard Test Method for Surface Flammability of Materials Using a Radiant Heat Energy Source.

Test methods referred to in the American reference standard specifying the performance criteria:

- **NFPA 130** Standard for Fixed Guideway Transit and Passenger Rail Systems.

Also widely used are the Bombardier Transportation smoke toxicity specifications:

- **SMP 800-C** Toxic Gas Generation.

In Italy, from 2006 to 31st March 2016, for installation on board railway vehicles, a certificate of conformity to the following Italian railway standards was required:

- **UNI CEI 11170-1:2005** Trains and trams – Fire safety guidelines for trains, trams and track guided vehicles – General principles;
- **UNI CEI 11170-2:2005** Trains and trams – Fire safety guidelines for trains, trams and track guided vehicles – Design recommendations – Fire containment measures – Indication, monitoring and evacuation systems;
- **UNI CEI 11170-3:2005** Trains and trams – Fire safety guidelines for trains, trams and track guided vehicles – Material fire behaviour assessment – Acceptance limits

published jointly by UNI and CEI on 2005-11-30 with parallel validity until 31st March 2016. In these standards, the requirements for materials relating to electrical connectors are contained in the 2nd schedule “Acceptability criteria for electrical and electronic materials and components” at the application “All other applications including flammable materials” (all applications other than electric cables). For these applications, four material tests are required:

- Exposure to a small flame according to EN ISO 11925-2 with, depending on the level of risk, a resistance to fire of the material of 15 s for LR1 and LR2 and a resistance of 30 s for LR3 and LR4.

- Smokiness in compliance with French standard NF F 16-101 with IF better or equal to F2 for all risk levels. The material we use is classified as F1 (better than F2) according to the tests carried out.

- Smoke optical density measurement, in compliance with French standard NF X 10-702 (from NF F 16-101) with values ≤ 100 for all risk levels LR1...4.

- Toxicity measurement, in compliance with Italian standard CEI 20-37/7, with T ≤ 2 for all risk levels LR1...4.

Tests

EU – The material tested in accordance with the European Norm **EN 45545-2:2013** – showed an oxygen index (OI) of 38%, a D_s max (flaming) = 117 and a smoke toxicity index CITNLP = 0,16, **compliant with the requirements of EN 45545-2:2013 for all risk levels: HL1 – HL2 – HL3** and, consequently, for all the design categories (A, D, S, N) and operation categories (1, 2, 3, 4) defined in EN 45545-1:2013.

France - The material used in our connectors is certified by an accredited laboratory CERTIFER, according to the previously mentioned French standards **NF F 16-101** and **NF F 16-102**, and has a **classification F1** (Index Fumée I.F. = 15) and a smoke toxicity index (Index Toxicité Fumée) **I.T.C. = 18**.

Both values meet the requirements set out by the French standards and by the Italian standard UNI CEI 11170-3 schedule 2, which relates to electrical connectors.

Germany – The material used in our connectors also complies with the German standard **DIN 5510-2:2009** with a **flammability class = S4**, **smoke spreading class = SR2** and **drip class = ST2**.

UK - The material was also tested according to British Standard **BS 6853:1999**, with an **R (max) index = 0,6**, consequently within the limits of Tables 7 and 8 of the standard for vehicle categories Ia, Ib and II.

USA - Tests compliant with American standards have also been carried out at a qualified North American laboratory, confirming compliance with the requirements set out by the US Federal Transit Administration “Recommended Fire Safety Practices for Rail Transit Material Selection” for methods ASTM E 662 (NFPA 258) (specific optical smoke density), ASTM E 162 (ASTM D 3635) (surface flammability → flame propagation index) and Bombardier Transportation SMP 800-C (smoke and gas toxicity).

Standards and Certifications

cUL[®] us mark

ILME enclosures have been certified by UL as Recognised Components for the USA and Canada (cUL mark) as accessories of our set of UL and CSA certified connector inserts (file UL E115072, file CSA 082270_0_000).

The certification has been achieved by successfully completing several tests carried out in compliance with standard **ANSI/UL 50** (Enclosures for Electrical Equipment) which is equivalent to the North American voluntary standard **NEMA 250** (NEMA = National Electrical Manufacturers Association) and to the equivalent Canadian standard **CSA C22.2 No.94** (Special Purpose Enclosures) for safety levels used in North America and required by the local installation codes (e.g.: NFPA 70 National Electrical Code in the US, CSA system standards for Canada); more specifically:

- **Type 12** (= NEMA 12): for internal use, similar to IP54 protection rating according to IEC/EN 60529; it covers Type 1 and Type 2.
- **Type 4** (= NEMA 4): for internal and external use, similar to IP66.
- **Type 4X** (= NEMA 4X): for internal and external use, as Type 4 + corrosion resistance, similar to IP66 protection rating.

The certification includes the enclosure series with ISO, Pg and metric cable entry as well as NPT, all special versions similar to standard types.



Specifications



ISO 23570-3 standard and DESINA[®] specification compliant

Connectors compliant with DESINA[®] standard

DESINA[®] (which stands for **DE**centralised and **Standardised IN**stallation technology) is an innovative installation concept behind a study headed by the German manufacturers of machine tools association (VDW), with the co-operation of users (including German automotive manufacturers) and component manufacturers, which has led to the introduction of a specification aimed to standardise electrical, hydraulic and pneumatic components and their interconnection on common platform for CNC controlled machine tools and manufacturing lines.

In the last few years, the DESINA[®] specification has been successfully enclosed in the ISO TC 184/SC 1 "Industrial automation systems and integration / Physical device control" as an ISO standard.

This work has been completed, and the following standards have now become available:

ISO 23570-1 Industrial automation systems and integration – Distributed installation in industrial applications: Part 1 – Sensors and actuators.

ISO 23570-2 Industrial automation systems and integration – Distributed installation in industrial applications: Part 2 – Hybrid communication bus.

ISO 23570-3 Industrial automation systems and integration – Distributed installation in industrial applications: Part 3 – Power distribution bus.



EUROMAP (European Plastics and Rubber Machinery)

ILME connectors meet the Technical Recommendations:

- EUROMAP 12: CSAH / CDA / CDC inserts, 32 poles.
- EUROMAP 13: CSAH / CDA / CDC inserts, 16 poles.
- EUROMAP 14 – part 1: CSAH / CDA / CDC inserts, 16 poles (with CDC inserts the iron and constantan thermocouple crimp contacts may also be used).
- EUROMAP 14 – part 2: CSH / CNE / CCE / CSE inserts, 16 poles
- CP inserts, 6 poles.
- EUROMAP 16: CD inserts, 8 poles, CSAH / CDA / CDC inserts, 10 poles.
- EUROMAP 27-1: MIXO inserts, CX 08 C and CX 04 B.
- EUROMAP 28: CSH / CSE inserts, 6 poles.
- EUROMAP 29: CSH / CSE inserts, 24 poles.
- EUROMAP 62: CSAH / CDA / CDC inserts, 32 poles.
- EUROMAP 67: CD inserts, 50 poles (CD 25 Z version).
- EUROMAP 67.1: CD inserts, 50 poles (CD 25 Z version).
- EUROMAP 70: MIXO inserts, CX 12 D.
- EUROMAP 71: CD inserts, 50 poles (CD 25 Z version).
- EUROMAP 73: MIXO inserts, CX 12 D.
- EUROMAP 74: MIXO inserts, CX 12 D.
- EUROMAP 78: MIXO inserts, CX 12 D.

Visit ilme.com website to discover all the main features:



Technical datasheets
to get all the information about our products.



Application pages
to focus on installation locations, field requirements and technical details.



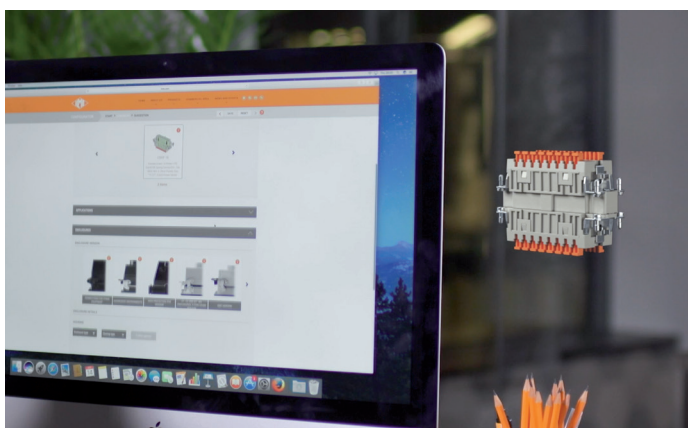
Download Area
to find all the useful files in a click.



Get into our **Configurator** to easily find the right solution that fits your needs

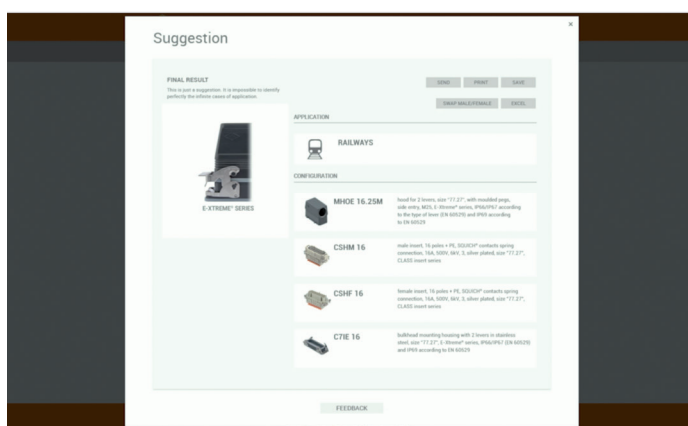


 search



Over
50 million
connector
combinations.

 choose



Easy selection
of individual parts
for key applications
and recommendations
for custom
environmental
conditions.

 download



Smart
suggestion
to get the
most suitable
configuration.

A

AH M25IF 505
 AH M25IFL 505
 AH M32IF 505
 AH M32IFL 505
 AT 8FT 237
 AT 8IFT 237
 AT LCMM 237
 AT LCSM 237
 AT U2F 237
 AT U3F 237
 ATR C22 237
 AW M25IJ 233
 AW M25INJ 233
 AW M25PJ 233

C

C7 06 FL 443
 C7 10 FL 443
 C7 16 FL 443
 C7 24 FL 443
 C7AP 06 L 436
 C7AP 06 L2 436
 C7AP 06 L229 436
 C7AP 06 L29 436
 C7AP 10.21 438
 C7AP 10.221 438
 C7AP 10.229 438
 C7AP 10.29 438
 C7AP 16.21 439
 C7AP 16.221 439
 C7AP 16.229 439
 C7AP 16.29 439
 C7AP 24.21 441
 C7AP 24.221 441
 C7AP 24.229 441
 C7AP 24.29 441
 C7ES 720
 C7I 06 L 436, 656
 C7I 06 LS 437
 C7I 10 438, 656
 C7I 16 439, 656
 C7I 16 S 440
 C7I 24 441, 656
 C7I 24 S 442
 C7IE 06 L 530
 C7IE 10 532
 C7IE 16 534
 C7IE 24 536
 C7P 06 L 436
 C7P 06 L2 436
 C7P 10 438
 C7P 10.2 438
 C7P 16 439
 C7P 16.2 439
 C7P 24 441
 C7P 24.2 441
 CAC 06 L 392
 CAC 10 401
 CAC 10 L 401
 CAC 16 411
 CAC 16 L 411
 CAC 24 423
 CAC 24 L 423
 CAC 50 434
 CAF 10 395
 CAF 16 404
 CAF 16.221 406
 CAF 24.21 414
 CAF 24.221 416
 CAF 24.29 414
 CAN 24 421
 CAO 06 L21 389

CAO 06 L29 389
 CAO 06 YX21 604
 CAO 06 YX29 604
 CAO 10 L21 396
 CAO 10 L29 396
 CAO 10 X 400
 CAO 10 X29 400
 CAO 10 YX21 607
 CAO 10 YX29 607
 CAO 10.21 395
 CAO 10.29 395
 CAO 16 L21 405
 CAO 16 L29 405
 CAO 16 X 410
 CAO 16 X29 410
 CAO 16 YX21 610
 CAO 16 YX29 610
 CAO 16.21 404
 CAO 16.29 404
 CAO 24 L21 415
 CAO 24 L29 415
 CAO 24 X 422
 CAO 24 X29 422
 CAO 24 YX21 613
 CAO 24 YX29 613
 CAO 24.21 414
 CAO 24.29 414
 CAO 50 X 433
 CAO 50 X29 433
 CAO 50.21 432
 CAO 50.29 432
 CAOR 06 L21 586
 CAOR 10.21 587
 CAOR 16.21 588
 CAOR 24.29 589
 CAOS 10.21 579
 CAOS 16.29 580
 CAOS 24.29 581
 CAOW 06 L21 521
 CAOW 10.21 522
 CAOW 16.29 523
 CAOW 24.29 524
 CAOW 50.29 527
 CAP 06 L 388
 CAP 06 L2 388
 CAP 06 L229 388
 CAP 06 L29 388
 CAP 06 LS 388
 CAP 06 LS2 388
 CAP 06 LS229 388
 CAP 06 LS29 388
 CAP 06 YC229 603
 CAP 10 CP 394
 CAP 10 CP2 394
 CAP 10 CP229 394
 CAP 10 CP29 394
 CAP 10 CS 394
 CAP 10 CS2 394
 CAP 10 CS229 394
 CAP 10 CS29 394
 CAP 10 L 394
 CAP 10 L2 394
 CAP 10 L229 394
 CAP 10 L29 394
 CAP 10 LS 394
 CAP 10 LS2 394
 CAP 10 LS229 394
 CAP 10 LS29 394
 CAP 10 YC229 606
 CAP 10.21 394
 CAP 10.221 394
 CAP 10.229 394
 CAP 10.29 394
 CAP 16 CP 403

CAP 16 CP2 403
 CAP 16 CP229 403
 CAP 16 CP29 403
 CAP 16 CS 403
 CAP 16 CS2 403
 CAP 16 CS229 403
 CAP 16 CS29 403
 CAP 16 L 403
 CAP 16 L2 403
 CAP 16 L229 403
 CAP 16 L29 403
 CAP 16 LS 403
 CAP 16 LS2 403
 CAP 16 LS229 403
 CAP 16 LS29 403
 CAP 16 YC229 609
 CAP 16.21 403
 CAP 16.221 403
 CAP 16.229 403
 CAP 16.29 403
 CAP 24 CP 413
 CAP 24 CP2 413
 CAP 24 CP229 413
 CAP 24 CP29 413
 CAP 24 CS 413
 CAP 24 CS2 413
 CAP 24 CS229 413
 CAP 24 CS29 413
 CAP 24 G36 657
 CAP 24 L 413
 CAP 24 L2 413
 CAP 24 L229 413
 CAP 24 L29 413
 CAP 24 LS 413
 CAP 24 LS2 413
 CAP 24 LS229 413
 CAP 24 LS29 413
 CAP 24 YC229 612
 CAP 24.21 413
 CAP 24.221 413
 CAP 24.229 413
 CAP 24.29 413
 CAPR 10.21 587
 CAPR 16.21 588
 CAPR 24.21 589
 CAPS 06 L 578
 CAPS 10.21 579
 CAPS 16.21 580
 CAPS 24.21 581
 CAPW 06 L 521
 CAPW 10.21 522
 CAPW 16.21 523
 CAPW 24.21 524
 CAV 06 GYC21 605
 CAV 06 GYC29 605
 CAV 06 L21 389
 CAV 06 L29 389
 CAV 06 LG21 390
 CAV 06 LG29 390
 CAV 06 YX21 604
 CAV 06 YX29 604
 CAV 10 G 398
 CAV 10 G29 398
 CAV 10 GYC21 608
 CAV 10 GYC29 608
 CAV 10 L21 396
 CAV 10 L29 396
 CAV 10 LG21 399
 CAV 10 LG29 399
 CAV 10 X 400
 CAV 10 X29 400
 CAV 10 YX21 607
 CAV 10 YX29 607
 CAV 10.21 395

CAV 10.213 397
 CAV 10.29 395
 CAV 16 G 408
 CAV 16 G29 408
 CAV 16 GYC21 611
 CAV 16 GYC29 611
 CAV 16 L21 405
 CAV 16 L29 405
 CAV 16 LG21 409
 CAV 16 LG29 409
 CAV 16 X 410
 CAV 16 X29 410
 CAV 16 YX21 610
 CAV 16 YX29 610
 CAV 16.21 404
 CAV 16.216 406
 CAV 16.221 406
 CAV 16.29 404
 CAV 24 G 419
 CAV 24 G29 419
 CAV 24 GYC21 614
 CAV 24 GYC29 614
 CAV 24 L21 415
 CAV 24 L29 415
 CAV 24 LG21 420
 CAV 24 LG29 420
 CAV 24 X 422
 CAV 24 X29 422
 CAV 24 YX21 613
 CAV 24 YX29 613
 CAV 24.21 414
 CAV 24.221 416
 CAV 24.229 416
 CAV 24.29 414
 CAV 50 G29 432
 CAV 50 X 433
 CAV 50 X29 433
 CAV 50.21 432
 CAV 50.29 432
 CAVR 06 L21 586
 CAVR 10.21 587
 CAVR 16.21 588
 CAVR 24.29 589
 CAVS 10.21 579
 CAVS 16.29 580
 CAVS 24.29 581
 CAVW 06 L21 521
 CAVW 06 LG 521
 CAVW 10 G 522
 CAVW 10.21 522
 CAVW 16 G29 523
 CAVW 16.29 523
 CAVW 24.29 524
 CAVW 50.29 527
 CBC 06 L 467
 CBC 10 469
 CBC 16 471
 CBC 24 473
 CBGF 698
 CC 0.5 AN 104*
 CC 0.7 AN 104*
 CC 1.0 AN 104*
 CC 1.5 AN 104*
 CC 2.5 AN 104*
 CCEF 06 130
 CCEF 10 131
 CCEF 16 132, 134
 CCEF 16 N 134
 CCEF 24 133, 135
 CCEF 24 N 135
 CCEM 06 130
 CCEM 10 131
 CCEM 16 132, 134
 CCEM 16 N 134

* These items are also shown in various sections throughout the catalogue

CCEM 24.....	133, 135	CCMJD 1.5.....	675	CDF2D 0.5.....	674	CFF 10.....	395
CCEM 24 N.....	135	CCMJD 2.5.....	675	CDF2D 0.7.....	674	CFF 16.....	404
CCES.....	708*	CCMJD 3.0.....	675	CDF2D 1.0.....	674	CFF 16.221.....	406
CCF2D 0.3.....	675	CCMJD 4.0.....	675	CDF2D 1.5.....	674	CFF 24.21.....	414
CCF2D 0.5.....	675	CCPNP.....	708*	CDF2D 2.5.....	674	CFF 24.221.....	416
CCF2D 0.7.....	675	CCPNP RN.....	714	CDFA 0.3.....	66*	CFF 24.29.....	414
CCF2D 1.0.....	675	CCPR RN.....	708*	CDFA 0.5.....	66*	CFO 06 L21.....	389
CCF2D 1.5.....	675	CCPZ MIL.....	708	CDFA 0.7.....	66*	CFO 06 L29.....	389
CCF2D 2.5.....	675	CCPZ RN.....	714	CDFA 1.0.....	66*	CFO 10 L21.....	396
CCF2D 3.0.....	675	CCPZ TP.....	710	CDFA 1.5.....	66*	CFO 10 L29.....	396
CCF2D 4.0.....	675	CCPZP.....	722	CDFA 2.5.....	66*	CFO 10.21.....	395
CCFA 0.3.....	104*	CCPZPA.....	724	CDFA 6A.....	670	CFO 10.29.....	395
CCFA 0.5.....	104*	CCSPZP.....	722, 726	CDFA 6A28.....	672	CFO 16 L21.....	405
CCFA 0.7.....	104*	CCTP 10.....	708, 722	CDFD 0.3.....	66*	CFO 16 L29.....	405
CCFA 1.0.....	104*	CCTP 16.....	708, 722	CDFD 0.5.....	66*	CFO 16.21.....	404
CCFA 1.5.....	104*	CCTPACF.....	724	CDFD 0.7.....	66*	CFO 16.29.....	404
CCFA 2.5.....	104*	CCTPACM.....	724	CDFD 1.0.....	66*	CFO 24 L21.....	415
CCFA 3.0.....	104*	CCTPADF.....	724	CDFD 1.5.....	66*	CFO 24 L29.....	415
CCFA 4.0.....	104*	CCTPADM.....	724	CDFD 2.5.....	66*	CFO 24.21.....	414
CCFC 0.3.....	673	CCVPP.....	722	CDFD 6A.....	670	CFO 24.29.....	414
CCFC 0.5.....	673	CCW CT.....	739	CDFJD 0.3.....	674	CFO 32.....	426
CCFD 0.3.....	104*	CCW M25.....	739	CDFJD 0.5.....	674	CFO 32 L.....	426
CCFD 0.5.....	104*	CCW M32.....	739	CDFJD 0.7.....	674	CFO 32 X.....	427
CCFD 0.7.....	104*	CCW PD 03.....	739	CDFJD 1.0.....	674	CFO 32.29.....	426
CCFD 1.0.....	104*	CCW PD 03IVG.....	739	CDFJD 1.5.....	674	CFO 32.42.....	426
CCFD 1.5.....	104*	CCW PD 03G.....	739	CDFJD 2.5.....	674	CFO 48 L.....	430
CCFD 2.5.....	104*	CCW PD 06.....	739	CDM 07.....	66	CFO 48 L29.....	430
CCFD 3.0.....	104*	CCW PD 10.....	739	CDM 07 N.....	66	CFO 48 L42.....	430
CCFD 4.0.....	104*	CCW PD 15.....	739	CDM 08.....	67	CFO 50 X.....	433
CCFF 0.3.....	673	CCW PD 16.....	739	CDM 15.....	68	CFO 50 X29.....	433
CCFF 0.5.....	673	CCW PD 1M.....	739	CDM 25.....	69, 71	CFO 50.21.....	432
CCFFA.....	671	CCW PD 24.....	739	CDM 25 Z.....	71	CFO 50.29.....	432
CCFJD 0.3.....	675	CCW PD 25.....	739	CDM 40.....	70, 73	CFOS 06 L21.....	578
CCFJD 0.5.....	675	CDAF 10.....	98	CDM 64.....	72, 74	CFV 06 GYC21.....	605
CCFJD 0.7.....	675	CDAF 10 X.....	98	CDM2D 0.3.....	674	CFV 06 GYC29.....	605
CCFJD 1.0.....	675	CDAF 16.....	100, 102	CDM2D 0.5.....	674	CFV 06 L21.....	389
CCFJD 1.5.....	675	CDAF 16 N.....	102	CDM2D 0.7.....	674	CFV 06 L29.....	389
CCFJD 2.5.....	675	CDAF 16 X.....	100, 102	CDM2D 1.0.....	674	CFV 06 LG21.....	390
CCFJD 3.0.....	675	CDAF 16 XN.....	102	CDM2D 1.5.....	674	CFV 06 LG29.....	390
CCFJD 4.0.....	675	CDAM 10.....	98	CDM2D 2.5.....	674	CFV 10 G.....	398
CCINA.....	708*	CDAM 10 X.....	98	CDMA 0.3.....	66*	CFV 10 G29.....	398
CCM2D 0.3.....	675	CDAM 16.....	100, 102	CDMA 0.5.....	66*	CFV 10 GYC21.....	608
CCM2D 0.5.....	675	CDAM 16 N.....	102	CDMA 0.7.....	66*	CFV 10 GYC29.....	608
CCM2D 0.7.....	675	CDAM 16 X.....	100, 102	CDMA 1.0.....	66*	CFV 10 L21.....	396
CCM2D 1.0.....	675	CDAM 16 XN.....	102	CDMA 1.5.....	66*	CFV 10 L29.....	396
CCM2D 1.5.....	675	CDCF 10.....	104	CDMA 2.5.....	66*	CFV 10 LG21.....	399
CCM2D 2.5.....	675	CDCF 16.....	105, 106	CDMA 6A.....	670, 672	CFV 10 LG29.....	399
CCM2D 3.0.....	675	CDCF 16 N.....	106	CDMD 0.3.....	66*	CFV 10.21.....	395
CCM2D 4.0.....	675	CDCM 10.....	104	CDMD 0.5.....	66*	CFV 10.213.....	397
CCMA 0.3.....	104*	CDCM 16.....	105, 106	CDMD 0.7.....	66*	CFV 10.29.....	395
CCMA 0.5.....	104*	CDCM 16 N.....	106	CDMD 1.0.....	66*	CFV 16 G.....	408
CCMA 0.7.....	104*	CDDF 108.....	81, 83	CDMD 1.5.....	66*	CFV 16 G29.....	408
CCMA 1.0.....	104*	CDDF 108 N.....	83	CDMD 2.5.....	66*	CFV 16 GYC21.....	611
CCMA 1.5.....	104*	CDDF 24.....	76	CDMD 6A.....	670	CFV 16 GYC29.....	611
CCMA 2.5.....	104*	CDDF 38.....	77, 80	CDMJD 0.3.....	674	CFV 16 L21.....	405
CCMA 3.0.....	104*	CDDF 42.....	78	CDMJD 0.5.....	674	CFV 16 L29.....	405
CCMA 4.0.....	104*	CDDF 72.....	79, 82	CDMJD 0.7.....	674	CFV 16 LG21.....	409
CCMC 0.3.....	673	CDDF 72 N.....	82	CDMJD 1.0.....	674	CFV 16 LG29.....	409
CCMC 0.5.....	673	CDDM 108.....	81, 83	CDMJD 1.5.....	674	CFV 16.21.....	404
CCMD 0.3.....	104*	CDDM 108 N.....	83	CDMJD 2.5.....	674	CFV 16.216.....	406
CCMD 0.5.....	104*	CDDM 24.....	76	CDSHF 06 NC.....	95	CFV 16.221.....	406
CCMD 0.7.....	104*	CDDM 38.....	77, 80	CDSHF 09.....	86	CFV 16.29.....	404
CCMD 1.0.....	104*	CDDM 42.....	78	CDSHF 17.....	87	CFV 24 G.....	419
CCMD 1.5.....	104*	CDDM 72.....	79, 82	CDSHF 27.....	88, 90	CFV 24 G29.....	419
CCMD 2.5.....	104*	CDDM 72 N.....	82	CDSHF 27 N.....	90	CFV 24 GYC21.....	614
CCMD 3.0.....	104*	CDF 07.....	66	CDSHF 42.....	89, 91	CFV 24 GYC29.....	614
CCMD 4.0.....	104*	CDF 07 N.....	66	CDSHF 42 N.....	91	CFV 24 L21.....	415
CCMF 0.3.....	673	CDF 08.....	67	CDSHM 06 NC.....	95	CFV 24 L29.....	415
CCMF 0.5.....	673	CDF 15.....	68	CDSHM 09.....	86	CFV 24 LG21.....	420
CCMFA.....	671	CDF 25.....	69, 71	CDSHM 18.....	87	CFV 24 LG29.....	420
CCMJD 0.3.....	675	CDF 25 Z.....	71	CDSHM 27.....	88, 90	CFV 24.21.....	414
CCMJD 0.5.....	675	CDF 40.....	70, 73	CDSHM 27 N.....	90	CFV 24.221.....	416
CCMJD 0.7.....	675	CDF 64.....	72, 74	CDSHM 42.....	89, 91	CFV 24.29.....	414
CCMJD 1.0.....	675	CDF2D 0.3.....	674	CDSHM 42 N.....	91	CFV 32.....	426

* These items are also shown in various sections throughout the catalogue

CFV 32 G.....	426	CGO 06.16 B.....	635	CHC 16 C.....	410	CHCS 24.....	581
CFV 32 G29.....	426	CGO 06.21.....	633	CHC 16 G.....	410	CHCS 24 G.....	581
CFV 32 G42.....	426	CGO 06.21 B.....	635	CHC 16 L.....	410	CHCS 24 S.....	581
CFV 32 L.....	426	CGO 06.29.....	633	CHC 16 LG.....	410	CHCW 06 L.....	521
CFV 32 LG.....	426	CGO 06.29 B.....	635	CHC 16 S.....	410	CHCW 06 LG.....	521
CFV 32 X.....	427	CGO 10.16.....	637	CHC 16 SL.....	410	CHCW 06 SL.....	521
CFV 32.29.....	426	CGO 10.16 B.....	639	CHC 24.....	422	CHCW 10.....	522
CFV 32.42.....	426	CGO 10.21.....	637	CHC 24 C.....	422	CHCW 10 G.....	522
CFV 48 L.....	430	CGO 10.21 B.....	639	CHC 24 G.....	422	CHCW 10 S.....	522
CFV 48 L29.....	430	CGO 10.29.....	637	CHC 24 L.....	422	CHCW 16.....	523
CFV 48 L42.....	430	CGO 10.29 B.....	639	CHC 24 LG.....	422	CHCW 16 G.....	523
CFV 50 G29.....	432	CGO 16.21.....	641	CHC 24 S.....	422	CHCW 16 S.....	523
CFV 50 X.....	433	CGO 16.21 B.....	643	CHC 24 SL.....	422	CHCW 24.....	524
CFV 50 X29.....	433	CGO 16.29.....	641	CHC 32.....	427	CHCW 24 G.....	524
CFV 50.21.....	432	CGO 16.29 B.....	643	CHC 32 C.....	427	CHCW 24 S.....	524
CFV 50.29.....	432	CGO 16.36.....	641	CHC 32 G.....	427	CHCW 32.....	525
CFVS 06 L21.....	578	CGO 16.36 B.....	643	CHC 32 L.....	427	CHCW 32 G.....	525
CG 06 FL.....	648	CGO 24.21.....	645	CHC 32 LG.....	427	CHCW 32 S.....	525
CG 10 FL.....	648	CGO 24.21 B.....	647	CHC 32 S.....	427	CHCW 50.....	527
CG 16 FL.....	648	CGO 24.29.....	645	CHC 32 SL.....	427	CHCW 50 G.....	527
CG 24 FL.....	648	CGO 24.29 B.....	647	CHC 50.....	433	CHCW 50 S.....	527
CGC 06.....	633	CGO 24.36.....	645	CHC 50 G.....	433	CHES.....	280
CGC 06 B.....	635	CGO 24.36 B.....	647	CHC 50 S.....	433	CHI 06 L.....	387, 656
CGC 10.....	637	CGP 06.29.....	632	CHCE 06 L.....	542	CHI 06 LC.....	387
CGC 10 B.....	639	CGP 10.29.....	636	CHCE 06 LG.....	542	CHI 06 LCH.....	656
CGC 16.....	641	CGP 16.36.....	640	CHCE 06 SL.....	542	CHI 06 LCP.....	387
CGC 16 B.....	643	CGP 24.236.....	644	CHCE 10.....	543	CHI 06 LCS.....	387
CGC 24.....	645	CGP 24.36.....	644	CHCE 10 G.....	543	CHI 06 LS.....	387
CGC 24 B.....	647	CGPZ LOC.....	720	CHCE 10 S.....	543	CHI 06 YC.....	603
CGCE 06.....	551	CGT 10.....	319	CHCE 16.....	544	CHI 10.....	393, 656
CGCE 10.....	553	CGT 16.....	264*	CHCE 16 G.....	544	CHI 10 C.....	393
CGCE 16.....	555	CGT 25.....	319	CHCE 16 S.....	544	CHI 10 CH.....	656
CGCE 24.....	557	CGT 6.0.....	319	CHCE 24.....	545	CHI 10 CP.....	393
CGCP 06 FX.....	697	CGV 06.16.....	633	CHCE 24 G.....	545	CHI 10 CS.....	393
CGCP 06 MB.....	697	CGV 06.16 B.....	635	CHCE 24 S.....	545	CHI 10 L.....	393
CGCP 10 FX.....	697	CGV 06.21.....	633	CHCE 32.....	546	CHI 10 LS.....	393
CGCP 10 MB.....	697	CGV 06.21 B.....	635	CHCE 32 G.....	546	CHI 10 YC.....	606
CGCP 16 FX.....	697	CGV 06.29.....	633	CHCE 32 S.....	546	CHI 16.....	402, 656
CGCP 16 MB.....	697	CGV 06.29 B.....	635	CHCE 50.....	548	CHI 16 C.....	402
CGCP 24 FX.....	697	CGV 10.16.....	637	CHCE 50 G.....	548	CHI 16 CH.....	656
CGCP 24 MB.....	697	CGV 10.16 B.....	639	CHCE 50 S.....	548	CHI 16 CP.....	402
CGD 10 C.....	720	CGV 10.21.....	637	CHCN 06 L.....	619	CHI 16 CS.....	402
CGD 16 C.....	720	CGV 10.21 B.....	639	CHCN 06 LG.....	619	CHI 16 L.....	402
CGD 25 C.....	720	CGV 10.29.....	637	CHCN 10.....	621	CHI 16 LS.....	402
CGD 35 C.....	720	CGV 10.29 B.....	639	CHCN 10 G.....	621	CHI 16 YC.....	609
CGFA 10.....	206*	CGV 16.21.....	641	CHCN 16.....	623	CHI 24.....	412, 656
CGFA 16.....	206*	CGV 16.21 B.....	643	CHCN 16 G.....	623	CHI 24 C.....	412
CGFA 25.....	206*	CGV 16.221.....	641	CHCN 24.....	625	CHI 24 CH.....	656
CGFA 35.....	206*	CGV 16.221 B.....	643	CHCN 24 G.....	625	CHI 24 CP.....	412
CGI 06.....	632	CGV 16.29.....	641	CHCP 06.....	696	CHI 24 CS.....	412
CGI 06 B.....	634	CGV 16.29 B.....	643	CHCP 10.....	696	CHI 24 L.....	412
CGI 10.....	636	CGV 16.36.....	641	CHCP 10 V.....	696	CHI 24 LS.....	412
CGI 10 B.....	638	CGV 16.36 B.....	643	CHCP 16.....	696	CHI 24 YC.....	612
CGI 16.....	640	CGV 24.21.....	645	CHCP 24.....	696	CHI 32.....	424
CGI 16 B.....	642	CGV 24.21 B.....	647	CHCR 06 L.....	586	CHI 32 CS.....	424
CGI 24.....	644	CGV 24.229.....	645	CHCR 06 SL.....	586	CHI 32 L.....	424
CGI 24 B.....	646	CGV 24.229 B.....	647	CHCR 10.....	587	CHI 32 LS.....	424
CGIE 06.....	550	CGV 24.29.....	645	CHCR 10 G.....	587	CHI 48 L.....	430
CGIE 10.....	552	CGV 24.29 B.....	647	CHCR 10 S.....	587	CHI 48 LS.....	430
CGIE 16.....	554	CGV 24.36.....	645	CHCR 16.....	588	CHI 50.....	431
CGIE 24.....	556	CGV 24.36 B.....	647	CHCR 16 G.....	588	CHI 50 CS.....	431
CGK I.....	628	CH1ES.....	279	CHCR 16 S.....	588	CHIE 06 L.....	542
CGK I B.....	630	CHC 06 L.....	391	CHCR 24.....	589	CHIE 10.....	543
CGK IA.....	628	CHC 06 LC.....	391	CHCR 24 G.....	589	CHIE 16.....	544
CGK IAP13.....	628	CHC 06 LG.....	391	CHCR 24 S.....	589	CHIE 24.....	545
CGK V13.....	629	CHC 06 SL.....	391	CHCS 06 L.....	578	CHIE 32.....	546
CGK V13 B.....	631	CHC 10.....	400	CHCS 06 LG.....	578	CHIE 48 LS.....	547
CGKCP FX.....	697	CHC 10 C.....	400	CHCS 06 SL.....	578	CHIE 50.....	548
CGKCP MB.....	697	CHC 10 G.....	400	CHCS 10.....	579	CHIN 06 L.....	618
CGMA 10.....	206*	CHC 10 L.....	400	CHCS 10 G.....	579	CHIN 06 LCH.....	618
CGMA 16.....	206*	CHC 10 LG.....	400	CHCS 10 S.....	579	CHIN 10.....	620
CGMA 25.....	206*	CHC 10 S.....	400	CHCS 16.....	580	CHIN 10 CH.....	620
CGMA 35.....	206*	CHC 10 SL.....	400	CHCS 16 G.....	580	CHIN 16.....	622
CGO 06.16.....	633	CHC 16.....	410	CHCS 16 S.....	580	CHIN 16 CH.....	622

* These items are also shown in various sections throughout the catalogue

CHIN 24.....	624	CHP 16 L2.....	403	CHV 24 X.....	422	CK 03 CAN.....	340
CHIN 24 CH.....	624	CHP 16 LS.....	403	CHV 24.29.....	414	CK 03 CAS.....	340
CHIR 10.....	587	CHP 16 LS2.....	403	CHV 32.....	426	CK 03 CN.....	340
CHIR 16.....	588	CHP 16.2.....	403	CHV 32 G.....	426	CK 03 CS.....	340
CHIR 24.....	589	CHP 24.....	413	CHV 32 G29.....	426	CK 03 CX.....	340
CHIR 48 LS.....	590	CHP 24 CP.....	413	CHV 32 G42.....	426	CK 03 CXA.....	340
CHIS 06 L.....	578	CHP 24 CP2.....	413	CHV 32 L.....	426	CK 03 CXAN.....	340
CHIS 10.....	579	CHP 24 CS.....	413	CHV 32 LG.....	426	CK 03 CXN.....	340
CHIS 16.....	580	CHP 24 CS2.....	413	CHV 32 X.....	427	CK 03 I.....	339, 346
CHIS 24.....	581	CHP 24 L.....	413	CHV 32.29.....	426	CK 03 IA.....	339
CHIW 06 L.....	521	CHP 24 L2.....	413	CHV 32.42.....	426	CK 03 IAN.....	339
CHIW 10.....	522	CHP 24 LS.....	413	CHV 48 L.....	430	CK 03 IAPNS.....	339
CHIW 16.....	523	CHP 24 LS2.....	413	CHV 48 L29.....	430	CK 03 IAPS.....	339
CHIW 24.....	524	CHP 24.2.....	413	CHV 48 L42.....	430	CK 03 IN.....	339, 346
CHIW 32.....	525	CHP 32.....	425	CHVR 06 L13.....	586	CK 03 VANS.....	340
CHIW 48 LS.....	526	CHP 32 L.....	425	CHVR 10.....	587	CK 03 VAS.....	340
CHIW 50.....	527	CHP 32 L2.....	425	CHVR 16.....	588	CK 03 VGNS.....	340
CHIX 32 L.....	428	CHP 32 L229.....	425	CHVR 24.....	589	CK 03 VGS.....	340
CHIX 32 LP.....	428	CHP 32 L242.....	425	CHVR 48 L.....	590	CK 03 VNS.....	340
CHIX 32 LS.....	428	CHP 32 L29.....	425	CHVS 16.....	580	CK 03 VS.....	340
CHO 06 L13.....	389	CHP 32 L42.....	425	CHVS 24.....	581	CKA 03 APS.....	349
CHO 06 L16.....	389	CHP 32 LS.....	425	CHVW 16.....	523	CKA 03 C.....	351
CHO 06 LX16.....	391	CHP 32 LS2.....	425	CHVW 24.....	524	CKA 03 CA.....	351
CHO 10.....	395	CHP 32 LS229.....	425	CHVW 24 G.....	524	CKA 03 CAS.....	351
CHO 10 L.....	396	CHP 32 LS242.....	425	CHVW 32.....	525	CKA 03 CS.....	351
CHO 10 X.....	400	CHP 32 LS29.....	425	CHVW 32 G.....	525	CKA 03 I.....	349, 353
CHO 16.....	404	CHP 32 LS42.....	425	CHVW 48 L.....	526	CKA 03 IA.....	349
CHO 16 L.....	405	CHP 32.2.....	425	CIES B.....	716	CKA 03 IA4.....	357
CHO 16 X.....	410	CHP 32.229.....	425	CIF 2.4.....	670	CKA 03 IAPS.....	349
CHO 24.....	414	CHP 32.242.....	425	CIF 2.4 A.....	670	CKA 03 ILS.....	350, 353
CHO 24 L.....	415	CHP 32.29.....	425	CIF Q08 1.6.....	671	CKA 03 ILSA.....	350
CHO 24 X.....	422	CHP 32.42.....	425	CIF Q4/2 2.4.....	672	CKA 03 VAS.....	351
CHO 32.....	426	CHP 48 LS.....	430	CIFA 0.2.....	190*	CKA 03 VGS.....	351
CHO 32 L.....	426	CHP 48 LS29.....	430	CIFA 0.3.....	190*	CKA 03 VS.....	351
CHO 32 X.....	427	CHP 50 CS.....	431	CIFA 0.5.....	190*	CKAG 03 C.....	353
CHO 32.29.....	426	CHP 50 CS2.....	431	CIFA 0.7.....	284	CKAG 03 V.....	354
CHO 32.42.....	426	CHP 50 CS229.....	431	CIFD 0.2.....	190*	CKAG 03 VA.....	354
CHO 48 L.....	430	CHP 50 CS29.....	431	CIFD 0.3.....	190*	CKAR 03 V.....	583
CHO 48 L29.....	430	CHP 50.21.....	431	CIFD 0.5.....	190*	CKAR 03 VA.....	583
CHO 48 L42.....	430	CHP 50.221.....	431	CIFD 0.7.....	284*	CKAS 03 IA4.....	565
CHO 50.....	432	CHP 50.229.....	431	CIMA 0.2.....	190*	CKAS 03 V.....	564
CHO 50 X.....	433	CHP 50.29.....	431	CIMA 0.3.....	190*	CKAS 03 VA.....	564
CHOR 06 L13.....	586	CHPR 10.....	587	CIMA 0.5.....	190*	CKAW 03 V.....	512
CHOR 10.....	587	CHPR 48 LS.....	590	CIMA 0.7.....	284	CKAW 03 VA.....	512
CHOR 16.....	588	CHPW 32.....	525	CIMD 0.2.....	190*	CKAX 03 APS.....	349
CHOR 24.....	589	CHPW 48 LS.....	526	CIMD 0.3.....	190*	CKAX 03 CX.....	351
CHOR 48 L.....	590	CHPW 50.21.....	527	CIMD 0.5.....	190*	CKAX 03 CXA.....	351
CHOS 16.....	580	CHPW 50.229.....	527	CIMD 0.7.....	284*	CKAX 03 I.....	349, 353
CHOS 24.....	581	CHPX 32 L.....	429	CIO 16.36.....	407	CKAX 03 IA.....	349
CHOW 16.....	523	CHPX 32 L29.....	429	CIO 24 YX36.....	613	CKAX 03 IA4.....	356
CHOW 24.....	524	CHPX 32 LP.....	429	CIO 24.36.....	417	CKAX 03 IAPS.....	349
CHOW 32.....	525	CHPX 32 LP29.....	429	CIPZ D.....	716	CKAX 03 ILS.....	350, 353
CHOW 48 L.....	526	CHPX 32 LS.....	429	CITP D.....	716	CKAX 03 ILSA.....	350
CHOW 50.....	527	CHPX 32 LS29.....	429	CIV 16.29.....	407	CKAX 03 VGS.....	351
CHP 06 L.....	388	CHSDS.....	701	CIV 24 YX36.....	613	CKAXE 03 I.....	538
CHP 06 L2.....	388	CHV 06 L13.....	389	CIV 24.36.....	417	CKAXE 03 IA.....	538
CHP 06 LS.....	388	CHV 06 L16.....	389	CIVES.....	716	CKAXR 03 AP.....	583
CHP 06 LS2.....	388	CHV 06 LG.....	390	CJ KF.....	223	CKAXR 03 I.....	583
CHP 10.....	394	CHV 06 LX16.....	391	CJ KM.....	223	CKAXR 03 IA.....	583
CHP 10 CP.....	394	CHV 10.....	395	CJK 8B IFT.....	228	CKAXR 03 IAP.....	583
CHP 10 CP2.....	394	CHV 10 G.....	398	CJK 8FT.....	226	CKAXR 03 VG.....	583
CHP 10 CS.....	394	CHV 10 L.....	396	CJK 8IFT.....	228	CKAXS 03 AP.....	564
CHP 10 CS2.....	394	CHV 10 LG.....	399	CJK 8IMT.....	226, 228	CKAXS 03 I.....	564
CHP 10 L.....	394	CHV 10 X.....	400	CJK 8M.....	233	CKAXS 03 IA.....	564
CHP 10 L2.....	394	CHV 16.....	404	CJK 8MT.....	226	CKAXS 03 IA4.....	565
CHP 10 LS.....	394	CHV 16 G.....	408	CJK 8P IFT.....	228	CKAXS 03 IAP.....	564
CHP 10 LS2.....	394	CHV 16 L.....	405	CJPW K.....	737	CKAXS 03 VG.....	564
CHP 10.2.....	394	CHV 16 LG.....	409	CJPZ T.....	736	CKAXW 03 AP.....	512
CHP 16.....	403	CHV 16 X.....	410	CJPZ Y.....	735	CKAXW 03 I.....	512
CHP 16 CP.....	403	CHV 24.....	414	CJST.....	735, 736	CKAXW 03 IA.....	512
CHP 16 CP2.....	403	CHV 24 G.....	419	CJZ 8 IN.....	224	CKAXW 03 IA4.....	513
CHP 16 CS.....	403	CHV 24 L.....	415	CJZA 8 I.....	224	CKAXW 03 IAP.....	512
CHP 16 CS2.....	403	CHV 24 L29.....	415	CK 03 C.....	340	CKAXW 03 VG.....	512
CHP 16 L.....	403	CHV 24 LG.....	420	CK 03 CA.....	340	CKAXX 03 IA4.....	357

* These items are also shown in various sections throughout the catalogue

CKAXXS 03IA4.....	565	CMSHM 10 N.....	144	CQEEF 64.....	177	CR 24 BPE.....	510, 655
CKAXXW 03IA4.....	513	CNEF 06 RY.....	116	CQEEM 40.....	176	CR 24 DF.....	601, 682
CKF 03.....	58	CNEF 06 T.....	110	CQEEM 64.....	177	CR 24 FS.....	680
CKF 03 N.....	58	CNEF 06 TX.....	110	CQEF 10.....	168	CR 24 SC.....	679
CKF 03 RY.....	60	CNEF 10 RY.....	117	CQEF 18.....	169	CR 24 SCA.....	679
CKF 04.....	58	CNEF 10 T.....	111	CQEF 32.....	170, 172	CR 24 SS.....	680
CKF 04 N.....	58	CNEF 10 TX.....	111	CQEF 32 N.....	172	CR 24 SSD.....	681
CKF 04 RY.....	60	CNEF 16 RY.....	118	CQEF 46.....	171, 173	CR 24 ST.....	678
CKFD 03.....	59	CNEF 16 T.....	112, 114	CQEF 46 N.....	173	CR 25 AD.....	700
CKFD 04.....	59	CNEF 16 TN.....	114	CQEM 10.....	168	CR 25 AD1.....	700
CKG 03 C.....	346	CNEF 16 TX.....	112, 114	CQEM 18.....	169	CR 25 AD2.....	700
CKG 03 CN.....	346	CNEF 16 TXN.....	114	CQEM 32.....	170, 172	CR 25/16.....	654
CKG 03 V.....	347	CNEF 24 RY.....	119, 120	CQEM 32 N.....	172	CR 26 V.....	680, 681
CKG 03 VA.....	347	CNEF 24 RYN.....	120	CQEM 46.....	171, 173	CR 37 AD.....	700
CKG 03 VAN.....	347	CNEF 24 T.....	113, 115	CQEM 46 N.....	173	CR 37 AD1.....	700
CKG 03 VN.....	347	CNEF 24 TN.....	115	CQES.....	708*	CR 37 AD2.....	700
CKM 03.....	58	CNEF 24 TX.....	113, 115	CQF 04/2.....	191	CR 42 V.....	680, 681
CKM 03 N.....	58	CNEF 24 TXN.....	115	CQF 05.....	186	CR 50 AD.....	700
CKM 03 RY.....	60	CNEM 06 RY.....	116	CQF 07.....	187	CR 50 AD1.....	700
CKM 03 T1.....	693	CNEM 06 T.....	110	CQF 08.....	192	CR 50 AD2.....	700
CKM 03 T3.....	693	CNEM 06 TX.....	110	CQF 12.....	189	CR 72.....	686
CKM 04.....	58	CNEM 10 RY.....	117	CQF 17.....	193	CR 72 CX.....	686
CKM 04 N.....	58	CNEM 10 T.....	111	CQF 21.....	190	CR 72 CX D.....	686
CKM 04 RY.....	60	CNEM 10 TX.....	111	CQM 04/2.....	191	CR 72 D.....	686
CKMD 03.....	59	CNEM 16 RY.....	118	CQM 05.....	186	CR BDE.....	694
CKMD 04.....	59	CNEM 16 T.....	112, 114	CQM 07.....	187	CR BLC622.....	667
CKR 65.....	339*	CNEM 16 TN.....	114	CQM 08.....	192	CR BST.....	695
CKR 65 D.....	339*	CNEM 16 TX.....	112, 114	CQM 12.....	189	CR CDS.....	86*
CKSHF 03.....	63	CNEM 16 TXN.....	114	CQM 17.....	193	CR CLK.....	666
CKSHF 04.....	63	CNEM 24 RY.....	119, 120	CQM 21.....	190	CR CP.....	689
CKSHM 03.....	63	CNEM 24 RYN.....	120	CQO 24.....	418	CR CPQ.....	689
CKSHM 04.....	63	CNEM 24 T.....	113, 115	CQS 08 I.....	573	CR CX01B.....	371
CKX 03 I.....	344	CNEM 24 TN.....	115	CQS 08 IA.....	573	CR CX01G.....	371
CKX 03 IA.....	344	CNEM 24 TX.....	113, 115	CQS 08 IAP.....	573	CR CX01N.....	371
CKX 03 IAP.....	344	CNEM 24 TXN.....	115	CQS 08 V.....	574	CR CX01R.....	371
CKX 03 IAPS.....	344	COB 06 BC.....	652	CQS 08 VA.....	574	CR GND.....	288*
CKX 03 IN.....	344	COB 06 CMS.....	653	CQS 08 VG.....	574	CR K03.....	688
CKX 03 VG.....	345	COB 10 BC.....	652	CQV 24.....	418	CR K04G.....	688
CKX 03 VGS.....	345	COB 10 CMS.....	653	CR 05 CA.....	678*	CR K04R.....	688
CL 125 SC.....	239, 301	COB 16 BC.....	652	CR 06 AT.....	678	CR KC.....	233
CL POF SC.....	239, 301	COB 16 CMS.....	653	CR 06 BPE.....	510, 655	CR Q02.....	691
CLC1.....	730, 732	COB 24 BC.....	652	CR 06 DF.....	601, 682	CR Q03.....	692
CLC4.....	730, 732	COB 24 CMS.....	653	CR 06 FS.....	680	CR Q12.....	689
CLDL.....	730	COB L.....	654	CR 06 SC.....	679	CR QF07.....	690
CLDL DD.....	732	COB TCQ.....	652	CR 06 ST.....	678	CR QM07.....	690
CLES.....	730, 734	COB TSF.....	653	CR 08 EMC.....	575	CR SP.....	680, 681
CLF DD.....	677	COB TSFS.....	653	CR 09 AD.....	700	CR TM-1.....	698
CLK 04 SCF.....	239	COPZ.....	734	CR 09 AD1.....	700	CR TT.....	262
CLK 04 SCF-H.....	239	COST.....	734	CR 09 AD2.....	700	CR VATG.....	668
CLK 04 SCM.....	239	CPES.....	699	CR 10 AT.....	678	CR VDTG.....	668
CLM DD.....	677	CPF 06.....	178, 179	CR 10 BPE.....	510, 655	CR VGM4.....	319
CLPZ R.....	730, 732	CPF 06 N.....	179	CR 10 CA.....	678*	CR VNTG.....	668
CLSG.....	730, 732	CPF 06 RY.....	178	CR 10 DF.....	601, 682	CR VPTG.....	668
CLSP.....	730, 732	CPM 06.....	178, 179	CR 10 FS.....	680	CR YLK24.....	667
CLTE.....	730, 732	CPM 06 N.....	179	CR 10 SC.....	679	CR YLK24 SL.....	667
CMCEF 03.....	137	CPM 06 RY.....	178	CR 10 ST.....	678	CRAD.....	669
CMCEF 06.....	139, 143	CPPZ C.....	720	CR 15 AD.....	700	CRAS.....	669
CMCEF 06 N.....	143	CPT 24.....	699	CR 15 AD1.....	700	CRBF.....	669
CMCEF 10.....	141, 145	CQ 08 C.....	367	CR 15 AD2.....	700	CRBM.....	669
CMCEF 10 N.....	145	CQ 08 CA.....	367	CR 15/16.....	654	CRF.....	685, 686
CMCEM 03.....	137	CQ 08 I.....	365	CR 16 AT.....	678	CRF CX.....	685, 686
CMCEM 06.....	139, 143	CQ 08 IA.....	365	CR 16 BPE.....	510, 655	CRF CX D.....	685, 686
CMCEM 06 N.....	143	CQ 08 IAP.....	365	CR 16 DF.....	601, 682	CRF D.....	685, 686
CMCEM 10.....	141, 145	CQ 08 V.....	366	CR 16 FS.....	680	CRH 24.....	702
CMCEM 10 N.....	145	CQ 08 VA.....	366	CR 16 SC.....	679	CRIC M3.....	668
CMSHF 03.....	136	CQ 08 VG.....	367	CR 16 SS.....	680	CRM.....	685, 686
CMSHF 06.....	138, 142	CQ4F 02.....	182	CR 16 SSD.....	681	CRM CX.....	685, 686
CMSHF 06 N.....	142	CQ4F 02 H.....	183	CR 16 ST.....	678	CRM CX D.....	685, 686
CMSHF 10.....	140, 144	CQ4F 03.....	184	CR 20.....	684	CRM D.....	685, 686
CMSHF 10 N.....	144	CQ4M 02.....	182	CR 20 CX.....	684	CRN 1.....	421
CMSHM 03.....	136	CQ4M 02 H.....	183	CR 20 CX D.....	684	CRN 2.....	421
CMSHM 06.....	138, 142	CQ4M 03.....	184	CR 20 D.....	684	CRN 3.....	421
CMSHM 06 N.....	142	CQAM 12 T1.....	693	CR 24 AT.....	678	CRN P.....	421
CMSHM 10.....	140, 144	CQEEF 40.....	176	CR 24 ATD.....	678	CRQ 16.....	367, 575

* These items are also shown in various sections throughout the catalogue

CRQ 21.....	367, 575	CTSEF 06 R.....	160	CVAP 24 L29.....	461	CVP 24 L.....	461
CRZ 06.....	702	CTSEF 10 L.....	161	CVAP 24 LP21.....	462	CVP 24 L2.....	461
CRZ 10.....	702	CTSEF 10 R.....	161	CVAP 24 LP29.....	462	CVP 24 LP.....	462
CRZ 16.....	702	CTSEF 16 L.....	162, 164	CVAP 24 LS.....	462	CVP 24 LP2.....	462
CRZ 24.....	702	CTSEF 16 LN.....	164	CVAP 24 LS2.....	462	CVP 24 LS.....	462
CSAHF 10.....	99	CTSEF 16 R.....	162, 164	CVAP 24 LS29.....	462	CVP 24 LS2.....	462
CSAHF 16.....	101, 103	CTSEF 16 RN.....	164	CVAP 24LP221.....	462	CVP 24 LSP21.....	460
CSAHF 16 N.....	103	CTSEF 24 L.....	163, 165	CVAP 24LP229.....	462	CVV 06 LG.....	447
CSAHM 10.....	99	CTSEF 24 LN.....	165	CVAP 24LS229.....	462	CVV 10 G.....	453
CSAHM 16.....	101, 103	CTSEF 24 R.....	163, 165	CVAP 24LSP21.....	460	CVV 10 LG.....	453
CSAHM 16 N.....	103	CTSEF 24 RN.....	165	CVAP 24LSP29.....	460	CVV 16 G.....	458
CSHES.....	738	CTSEM 06 L.....	160	CVAV 06 LG21.....	447	CVV 16 LG.....	458
CSHF 06.....	110	CTSEM 06 R.....	160	CVAV 06 LG29.....	447	CVV 24 G.....	463
CSHF 06 S.....	122	CTSEM 10 L.....	161	CVAV 10 G21.....	453	CVV 24 LG.....	463
CSHF 10.....	111	CTSEM 10 R.....	161	CVAV 10 G29.....	453	CW 0.5 J2M4E.....	308
CSHF 10 S.....	123	CTSEM 16 L.....	162, 164	CVAV 10 LG21.....	453	CW 0.5 J2M8.....	308
CSHF 16.....	112, 114	CTSEM 16 LN.....	164	CVAV 10 LG29.....	453	CW 0.5 JM4/2.....	308
CSHF 16 N.....	114	CTSEM 16 R.....	162, 164	CVAV 16 G21.....	458	CW 0.5 JM4E.....	308
CSHF 16 S.....	124, 126	CTSEM 16 RN.....	164	CVAV 16 G29.....	458	CW 0.5 JM8.....	308
CSHF 16 SN.....	126	CTSEM 24 L.....	163, 165	CVAV 16 LG21.....	458	CW 1 J2M87.....	227, 303
CSHF 24.....	113, 115	CTSEM 24 LN.....	165	CVAV 16 LG29.....	458	CW 1 SC50.....	240
CSHF 24 N.....	115	CTSEM 24 R.....	163, 165	CVAV 24 G21.....	463	CW 1 SC62.....	240
CSHF 24 S.....	125, 127	CTSEM 24 RN.....	165	CVAV 24 G29.....	463	CW 1 SC9.....	240
CSHF 24 SN.....	127	CTSF 40 L.....	156	CVAV 24 LG21.....	463	CW 10 J2M4E.....	308
CSHM 06.....	110	CTSF 40 R.....	156	CVAV 24 LG29.....	463	CW 10 J2M8.....	308
CSHM 06 S.....	122	CTSF 64 L.....	157	CVFV 06 LG21.....	447	CW 10 J2M87.....	227, 303
CSHM 10.....	111	CTSF 64 R.....	157	CVFV 06 LG29.....	447	CW 10 JM4/2.....	308
CSHM 10 S.....	123	CTSM 40 L.....	156	CVFV 10 G21.....	453	CW 10 JM4E.....	308
CSHM 16.....	112, 114	CTSM 40 R.....	156	CVFV 10 G29.....	453	CW 10 JM8.....	308
CSHM 16 N.....	114	CTSM 64 L.....	157	CVFV 10 LG21.....	453	CW 10 SC50.....	240
CSHM 16 S.....	124, 126	CTSM 64 R.....	157	CVFV 10 LG29.....	453	CW 10 SC62.....	240
CSHM 16 SN.....	126	CUK 2FT.....	236	CVFV 16 G21.....	458	CW 10 SC9.....	240
CSHM 24.....	113, 115	CUK 3FT.....	236	CVFV 16 G29.....	458	CW 15 J2M87.....	227, 303
CSHM 24 N.....	115	CVAP 06 LP.....	446	CVFV 16 LG21.....	458	CW 2 J2M4E.....	308
CSHM 24 S.....	125, 127	CVAP 06 LP2.....	446	CVFV 16 LG29.....	458	CW 2 J2M8.....	308
CSHM 24 SN.....	127	CVAP 06 LP29.....	446	CVFV 24 G21.....	463	CW 2 J2M87.....	227, 303
CSSF 06.....	148	CVAP 06 LS.....	446	CVFV 24 G29.....	463	CW 2 JM4/2.....	308
CSSF 10.....	149	CVAP 06 LS2.....	446	CVFV 24 LG21.....	463	CW 2 JM4E.....	308
CSSF 16.....	150, 152	CVAP 06 LS29.....	446	CVFV 24 LG29.....	463	CW 2 JM8.....	308
CSSF 16 N.....	152	CVAP 06LP229.....	446	CVI 06 LP.....	444	CW 2 SC50.....	240
CSSF 24.....	151, 153	CVAP 06LS229.....	446	CVI 06 LS.....	444	CW 2 SC62.....	240
CSSF 24 N.....	153	CVAP 06LSP21.....	445	CVI 06 LSP.....	445	CW 2 SC9.....	240
CSSM 06.....	148	CVAP 06LSP29.....	445	CVI 10 L.....	448	CW 2 UAM.....	236, 294
CSSM 10.....	149	CVAP 10 L21.....	451	CVI 10 LA.....	450	CW 3 J2M87.....	227, 303
CSSM 16.....	150, 152	CVAP 10 L221.....	451	CVI 10 LP.....	448	CW 3 SC50.....	240
CSSM 16 N.....	152	CVAP 10 L229.....	451	CVI 10 LS.....	448	CW 3 SC62.....	240
CSSM 24.....	151, 153	CVAP 10 L29.....	451	CVI 10 LSP.....	449	CW 3 SC9.....	240
CSSM 24 N.....	153	CVAP 10 LP21.....	452	CVI 16 L.....	454	CW 5 J2M4E.....	308
CT APE.....	669	CVAP 10 LP29.....	452	CVI 16 LP.....	454	CW 5 J2M8.....	308
CTF 06 L.....	160	CVAP 10 LS.....	452	CVI 16 LS.....	454	CW 5 J2M87.....	227, 303
CTF 06 R.....	160	CVAP 10 LS2.....	452	CVI 16 LSP.....	455	CW 5 JM4/2.....	308
CTF 10 L.....	161	CVAP 10 LS29.....	452	CVI 24 L.....	459	CW 5 JM4E.....	308
CTF 10 R.....	161	CVAP 10LP221.....	452	CVI 24 LP.....	459	CW 5 JM8.....	308
CTF 16 L.....	162	CVAP 10LP229.....	452	CVI 24 LS.....	459	CW 5 SC50.....	240
CTF 16 R.....	162	CVAP 10LS229.....	452	CVI 24 LSP.....	460	CW 5 SC62.....	240
CTF 24 L.....	163	CVAP 10LSP21.....	449	CVP 06 LP.....	446	CW 5 SC9.....	240
CTF 24 R.....	163	CVAP 10LSP29.....	449	CVP 06 LP2.....	446	CW 7.5J2M87.....	227, 303
CTF 40 L.....	156	CVAP 16 L21.....	456	CVP 06 LS.....	446	CW J5 10M.....	230
CTF 40 R.....	156	CVAP 16 L22.....	456	CVP 06 LS2.....	446	CW J5 15M.....	230
CTF 64 L.....	157	CVAP 16 L229.....	456	CVP 06 LSP16.....	445	CW J5 1M.....	230
CTF 64 R.....	157	CVAP 16 L29.....	456	CVP 10 L.....	451	CW J5 2M.....	230
CTM 06 L.....	160	CVAP 16 LP21.....	457	CVP 10 L2.....	451	CW J5 3M.....	230
CTM 06 R.....	160	CVAP 16 LP29.....	457	CVP 10 LP.....	452	CW J5 5M.....	230
CTM 10 L.....	161	CVAP 16 LS.....	457	CVP 10 LP2.....	452	CW J5 7.5M.....	230
CTM 10 R.....	161	CVAP 16 LS2.....	457	CVP 10 LS.....	452	CW J6 10M.....	229
CTM 16 L.....	162	CVAP 16 LS29.....	457	CVP 10 LS2.....	452	CW J6 15M.....	229
CTM 16 R.....	162	CVAP 16LP221.....	457	CVP 10 LSP16.....	449	CW J6 1M.....	229
CTM 24 L.....	163	CVAP 16LP229.....	457	CVP 16 L.....	456	CW J6 2M.....	229
CTM 24 R.....	163	CVAP 16LS229.....	457	CVP 16 L2.....	456	CW J6 3M.....	229
CTM 40 L.....	156	CVAP 16LSP21.....	455	CVP 16 LP.....	457	CW J6 5M.....	229
CTM 40 R.....	156	CVAP 16LSP29.....	455	CVP 16 LP2.....	457	CW J6 7.5M.....	229
CTM 64 L.....	157	CVAP 24 L21.....	461	CVP 16 LS.....	457	CW XJ0.5M.....	229
CTM 64 R.....	157	CVAP 24 L221.....	461	CVP 16 LS2.....	457	CW XJ10M.....	229
CTSEF 06 L.....	160	CVAP 24 L229.....	461	CVP 16 LSP21.....	455	CW XJ1M.....	229

* These items are also shown in various sections throughout the catalogue

CW XJ2M	229	CX 02 4M	267, 321	CX 42 DF	283, 332	CXMA 2.5	182*
CW XJ3M	229	CX 02 7F	266	CX 42 DM	283, 332	CXMA 4.0	182*
CW XJ5M	229	CX 02 7M	266	CX 4E JM	223*	CXMA 6.0	182*
CW XJ7.5M	229	CX 02 BF	288*	CX 5/7 CA	286	CXMFA	672
CWC J5 10M	230	CX 02 BM	288*	CX 50 RF	300	CXP 01 C	370
CWC J5 15M	230	CX 02 CHF	279	CX 50 RM	300	CXP 01 CLG	370
CWC J5 1M	230	CX 02 CHM	279	CX 6.0 PF	313	CXPNP	712
CWC J5 2M	230	CX 02 GF	265	CX 6.0 PM	313	CXPNPP	726
CWC J5 3M	230	CX 02 GM	265	CX 6.0 VC	313	CXPZ D	712
CWC J5 5M	230	CX 02 HF	280	CX 6/2 JM	223*	CXPZ TP	711
CWC J5 7.5M	230	CX 02 HM	280	CX 7/10 CA	286	CXPZP D	726
CWC J6 10M	229	CX 02 JF	306	CX 75 RF	300	CXTP 40	712, 726
CWC J6 15M	229	CX 02 JM	306	CX 75 RM	300	CYD 35 C	720
CWC J6 1M	229	CX 02 P	312	CX 8 J6IM	226*	CYD 50 C	720
CWC J6 2M	229	CX 02 TF	317	CX 8 J6M	226, 302	CYD 70 C	720
CWC J6 3M	229	CX 02 TM	317	CX 8 JF	223*	CYFA 16	262, 263
CWC J6 5M	229	CX 03 4BF	270, 323	CX 8 JM	223*	CYFA 25	262, 263
CWC J6 7.5M	229	CX 03 4BM	270, 323	CX 8/2 JF	223*	CYFA 35	262, 263
CWH J6 0.5MA	231	CX 03 4F	269, 322	CX BES	703	CYFA 50	262, 263
CWH J6 0.25M	231	CX 03 4M	269, 322	CX FM	309	CYFA 70	262, 263
CWH J6 0.5M	231	CX 03 P	312	CX MLF	299	CYG 06H06	660
CWH J6 10M	231	CX 03 TF	317	CX MLM	299	CYG 06H0606	661
CWH J6 10MA	231	CX 03 TM	317	CX PLF	299	CYG 06H0610	661
CWH J6 15M	231	CX 04 BF	291	CX PLM	299	CYG 06H06D	660
CWH J6 1M	231	CX 04 BM	291	CX7FA 10	266	CYG 06H10	660
CWH J6 1MA	231	CX 04 LF	299	CX7FA 16	266	CYG 06H1006	661
CWH J6 2M	231	CX 04 LM	299	CX7FA 25	266	CYG 06H1010	661
CWH J6 2MA	231	CX 04 RF	300	CX7MA 10	266	CYG 06H10D	660
CWH J6 3M	231	CX 04 RM	300	CX7MA 16	266	CYG 16	659
CWH J6 3MA	231	CX 04 SCF	301	CX7MA 25	266	CYG 8 JF	225
CWH J6 5M	231	CX 04 SCF-H	301	CX7PZ LOC	720	CYG 8 JFA	225
CWH J6 5MA	231	CX 04 SCM	301	CXA 01 I	369	CYG 8/2 JF	225
CWH J6 7.5M	231	CX 04 TF	317	CXES	711*	CYG 8/2 JFA	225
CWH J6 7.5MA	231	CX 04 TM	317	CXES-10	711*	CYMA 16	262, 263
CWH JE 0.5M	231	CX 04 XF	272, 325	CXF 12/2	199	CYMA 25	262, 263
CWH JE 10M	231	CX 04 XM	272, 325	CXF 4/0	200	CYMA 35	262, 263
CWH JE 15M	231	CX 05 SHF	274	CXF 4/0 RY	202	CYMA 50	262, 263
CWH JE 1M	231	CX 05 SHM	274	CXF 4/2	201	CYMA 70	262, 263
CWH JE 2M	231	CX 06 CF	275, 327	CXF 4/2 RY	203	CYPZ LOC	720
CWH JE 3M	231	CX 06 CM	275, 327	CXF 4/8	204	CYR 16.3	658
CWH JE 5M	231	CX 06 TF	317	CXF 4/8 RY	204	CYR 24.4	658
CWH JE 7.5M	231	CX 06 TM	317	CXF 6/12	197	CZ7CE 15 LG	540
CWK 10 J2M8	224	CX 06P CF	276, 326	CXF 6/36	198	CZ7CE 25 LG	541
CWK 2 J2M8	224	CX 06P CM	276, 326	CXF 6/6	206	CZ7CS 15 LG	576
CWK 5 J2M8	224	CX 08 BF	293	CXF 8/24	194	CZ7CS 25 LG	577
CWKA 10 J2M8	224	CX 08 BM	293	CXFA 1.5	182*	CZ7CW 15 LG	519
CWKA 2 J2M8	224	CX 08 CF	277, 328	CXFA 10	182*	CZ7CW 25 LG	520
CWKA 5 J2M8	224	CX 08 CM	277, 328	CXFA 2.5	182*	CZ7I 15 L	384
CX 01 9VF	296	CX 08 I6F	286	CXFA 4.0	182*	CZ7I 15 LS	384
CX 01 9VM	296, 298	CX 08 I6M	286	CXFA 6.0	182*	CZ7I 25 L	385
CX 01 9VTF	298	CX 1.6 PF	313	CXFFA	672	CZ7I 25 LS	385
CX 01 BCF	289	CX 1.6 PM	313	CXL 2/4 PF	251	CZ7IE 15 L	540
CX 01 BCM	289	CX 1.6 VC	313	CXL 2/4 PFF	251	CZ7IE 25 L	541
CX 01 BF	291	CX 1/2 BDF	243	CXL 2/4 PM	251	CZ7IS 15 L	576
CX 01 BM	291	CX 1/2 BDM	243	CXL 2/4 PMH	251	CZ7IS 25 L	577
CX 01 GF	264	CX 10/12 CA	286	CXL 2/4 SF	250	CZ7IW 15 L	519
CX 01 GM	264	CX 12 DF	281, 330	CXL 2/4 SM	250	CZ7IW 25 L	520
CX 01 J8F	302	CX 12 DM	281, 330	CXL PF	251	CZ7PS 15 L2	576
CX 01 J8IM	302	CX 17 DF	282, 331	CXL PM	251	CZ7PS 25 L2	577
CX 01 J8M	302	CX 17 DM	282, 331	CXL SF	250	CZ7PW 15 L2	519
CX 01 JF	304	CX 20 CF	278, 329	CXL SM	250	CZ7PW 25 L2	520
CX 01 JM	304	CX 20 CM	278, 329	CXM 12/2	199	CZAC 15 L	382
CX 01 T	316	CX 25 IBF	284	CXM 4/0	200	CZAC 25 L	382
CX 01 UF	294	CX 25 IBM	284	CXM 4/0 RY	202	CZAO 15 L16	376
CX 01 UM	294	CX 3.0 PF	313	CXM 4/2	201	CZAO 15 L21	376
CX 01 YF	262	CX 3.0 PM	313	CXM 4/2 RY	203	CZAO 25 L16	380
CX 01 YM	262	CX 3.0 VC	313	CXM 4/8	204	CZAO 25 L21	380
CX 01 YPEF	263	CX 3/4 XDF	271, 324	CXM 4/8 RY	204	CZAO 15 L21	519
CX 01 YPEM	263	CX 3/4 XDM	271, 324	CXM 6/12	197	CZAO 25 L21	520
CX 02 4AF	268	CX 4 JM	223*	CXM 6/36	198	CZAP 25 L	378
CX 02 4AM	268	CX 4.0 PF	313	CXM 6/6	206	CZAP 25 L2	378
CX 02 4BF	268	CX 4.0 PM	313	CXM 8/24	194	CZAP 25 L21	378
CX 02 4BM	268	CX 4.0 VC	313	CXMA 1.5	182*	CZAP 25 L221	378
CX 02 4F	267, 321	CX 4/2 JM	223*	CXMA 10	182*	CZAP 25 LS	378

* These items are also shown in various sections throughout the catalogue

CZAP 25 LS2.....	378	M7AP 06 L232.....	436	MAO 10.32.....	395	MAP 10.232.....	394
CZAP 25 LS21.....	378	M7AP 06 L240.....	436	MAO 10.40.....	395	MAP 10.240.....	394
CZAP 25LS221.....	378	M7AP 06 L32.....	436	MAO 16 L32.....	405	MAP 10.25.....	394
CZAP 25LSP16.....	379	M7AP 06 L40.....	436	MAO 16 L40.....	405	MAP 10.32.....	394
CZAP 25LSP21.....	379	M7AP 06 LS32.....	437	MAO 16 X32.....	410	MAP 10.40.....	394
CZAPR 06 L.....	586	M7AP 06 LS40.....	437	MAO 16 X40.....	410	MAP 16 CP232.....	403
CZAV 15 L16.....	376	M7AP 06LS232.....	437	MAO 16 YX32.....	610	MAP 16 CP240.....	403
CZAV 15 L21.....	376	M7AP 06LS240.....	437	MAO 16 YX40.....	610	MAP 16 CP32.....	403
CZAV 25 L16.....	380	M7AP 10.232.....	438	MAO 16.32.....	404	MAP 16 CP40.....	403
CZAV 25 L21.....	380	M7AP 10.240.....	438	MAO 16.40.....	404	MAP 16 CS232.....	403
CZAV 25 L216.....	380	M7AP 10.32.....	438	MAO 24 L32.....	415	MAP 16 CS240.....	403
CZAVV 15 L21.....	519	M7AP 10.40.....	438	MAO 24 L40.....	415	MAP 16 CS32.....	403
CZAVV 25 L21.....	520	M7AP 16 S232.....	440	MAO 24 X32.....	422	MAP 16 CS40.....	403
CZC 15 L.....	377	M7AP 16 S32.....	440	MAO 24 X40.....	422	MAP 16 L232.....	403
CZC 15 LG.....	377	M7AP 16.232.....	439	MAO 24 YX32.....	613	MAP 16 L240.....	403
CZC 15 SL.....	377	M7AP 16.240.....	439	MAO 24 YX40.....	613	MAP 16 L32.....	403
CZC 25 L.....	381	M7AP 16.32.....	439	MAO 24.32.....	414	MAP 16 L40.....	403
CZC 25 LG.....	381	M7AP 16.40.....	439	MAO 24.40.....	414	MAP 16 LS232.....	403
CZC 25 SL.....	381	M7AP 24 S232.....	442	MAO 50 X25.....	433	MAP 16 LS240.....	403
CZCE 15 L.....	540	M7AP 24 S32.....	442	MAO 50 X32.....	433	MAP 16 LS32.....	403
CZCE 25 L.....	541	M7AP 24.232.....	441	MAO 50.25.....	432	MAP 16 LS40.....	403
CZCR 06 LG.....	586	M7AP 24.240.....	441	MAO 50.32.....	432	MAP 16 YC232.....	609
CZCS 15 L.....	576	M7AP 24.32.....	441	MAOE 06 L32.....	542	MAP 16.225.....	403
CZCS 25 L.....	577	M7AP 24.40.....	441	MAOE 10.32.....	543	MAP 16.232.....	403
CZCW 15 L.....	519	M7APE 06 L32.....	530	MAOE 16.32.....	544	MAP 16.240.....	403
CZCW 25 L.....	520	M7APE 06 L40.....	530	MAOE 16.40.....	544	MAP 16.25.....	403
CZFO 15 L16.....	376	M7APE 06L232.....	530	MAOE 24.32.....	545	MAP 16.32.....	403
CZFO 15 L21.....	376	M7APE 06L240.....	530	MAOE 24.40.....	545	MAP 16.40.....	403
CZFO 25 L16.....	380	M7APE 10.232.....	532	MAOE 50.32.....	548	MAP 24 CP232.....	413
CZFO 25 L21.....	380	M7APE 10.240.....	532	MAOR 06 L32.....	586	MAP 24 CP240.....	413
CZFOS 15 L21.....	576	M7APE 10.32.....	532	MAOR 10.32.....	587	MAP 24 CP32.....	413
CZFOS 25 L21.....	577	M7APE 10.40.....	532	MAOR 16.40.....	588	MAP 24 CP40.....	413
CZFBV 15 L16.....	376	M7APE 16.232.....	534	MAOR 24.40.....	589	MAP 24 CS232.....	413
CZFBV 15 L21.....	376	M7APE 16.240.....	534	MAOS 10.32.....	579	MAP 24 CS240.....	413
CZFBV 25 L16.....	380	M7APE 16.32.....	534	MAOS 16.32.....	580	MAP 24 CS32.....	413
CZFBV 25 L21.....	380	M7APE 16.40.....	534	MAOS 16.40.....	580	MAP 24 CS40.....	413
CZFBV 25 L216.....	380	M7APE 24.232.....	536	MAOS 24.32.....	581	MAP 24 L232.....	413
CZFBV 25 L216.....	380	M7APE 24.240.....	536	MAOS 24.40.....	581	MAP 24 L240.....	413
CZFBV 25 L216.....	380	M7APE 24.32.....	536	MAOS 24.40.....	581	MAP 24 L32.....	413
CZFBV 25 L216.....	380	M7APE 24.32.....	536	MAOW 06 L32.....	521	MAP 24 L40.....	413
CZFBV 25 L216.....	380	M7APE 24.40.....	536	MAOW 10.32.....	522	MAP 24 LS232.....	413
CZFBV 25 L216.....	380	M7P 06 L20.....	436	MAOW 16.32.....	523	MAP 24 LS240.....	413
CZFBV 25 L216.....	380	M7P 06 L220.....	436	MAOW 16.40.....	523	MAP 24 LS32.....	413
CZFBV 25 L216.....	380	M7P 06 LS20.....	437	MAOW 24.32.....	524	MAP 24 LS40.....	413
CZFBV 25 L216.....	380	M7P 06 LS220.....	437	MAOW 24.40.....	524	MAP 24 YC232.....	612
CZFBV 25 L216.....	380	M7P 10.20.....	438	MAOW 50.32.....	527	MAP 24.225.....	413
CZFBV 25 L216.....	380	M7P 10.220.....	438	MAP 06 L225.....	388	MAP 06 L232.....	388
CZFBV 25 L216.....	380	M7P 16.225.....	439	MAP 06 L240.....	388	MAP 06 L25.....	388
CZFBV 25 L216.....	380	M7P 16.25.....	439	MAP 06 L32.....	388	MAP 06 L32.....	388
CZFBV 25 L216.....	380	M7P 24.225.....	441	MAP 06 L40.....	388	MAP 06 LS232.....	388
CZFBV 25 L216.....	380	M7P 24.25.....	441	MAP 06 L240.....	388	MAP 06 LS240.....	388
CZFBV 25 L216.....	380	M7PE 06 L20.....	530	MAP 06 L25.....	388	MAP 06 LS32.....	388
CZFBV 25 L216.....	380	M7PE 06 L220.....	530	MAP 06 L32.....	388	MAP 06 LS40.....	388
CZFBV 25 L216.....	380	M7PE 10.20.....	532	MAP 06 L40.....	388	MAP 06 YC232.....	603
CZFBV 25 L216.....	380	M7PE 10.20.....	532	MAP 06 LS232.....	388	MAP 10 CP232.....	394
CZFBV 25 L216.....	380	M7PE 10.220.....	532	MAP 06 LS240.....	388	MAP 10 CP240.....	394
CZFBV 25 L216.....	380	M7PE 16.225.....	534	MAP 06 LS32.....	388	MAP 10 CP32.....	394
CZFBV 25 L216.....	380	M7PE 16.25.....	534	MAP 06 LS40.....	388	MAP 10 CP40.....	394
CZFBV 25 L216.....	380	M7PE 24.225.....	536	MAP 06 YC232.....	603	MAP 10 CS232.....	394
CZFBV 25 L216.....	380	M7PE 24.225.....	536	MAP 10 CP232.....	394	MAP 10 CS240.....	394
CZFBV 25 L216.....	380	M7PE 24.25.....	536	MAP 10 CP240.....	394	MAP 10 CS32.....	394
CZFBV 25 L216.....	380	MAF 10.20.....	395	MAP 10 CP32.....	394	MAP 10 CS40.....	394
CZFBV 25 L216.....	380	MAF 16.225.....	406	MAP 10 CP40.....	394	MAP 10 L232.....	394
CZFBV 25 L216.....	380	MAF 16.25.....	404	MAP 10 CS232.....	394	MAP 10 L240.....	394
CZFBV 25 L216.....	380	MAF 24.225.....	416	MAP 10 CS240.....	394	MAP 10 L32.....	394
CZFBV 25 L216.....	380	MAF 24.25.....	414	MAP 10 CS32.....	394	MAP 10 L40.....	394
CZFBV 25 L216.....	380	MAF 24.32.....	414	MAP 10 CS40.....	394	MAP 10 LS232.....	394
CZFBV 25 L216.....	380	MAO 06 L25.....	389	MAP 10 LS240.....	394	MAP 10 LS32.....	394
CZFBV 25 L216.....	380	MAO 06 L32.....	389	MAP 10 LS40.....	394	MAP 10 YC232.....	606
CZFBV 25 L216.....	380	MAO 06 YX25.....	604	MAP 10 YC232.....	606	MAP 10.225.....	394
CZFBV 25 L216.....	380	MAO 06 YX32.....	604	MAP 10 YC232.....	606		
CZFBV 25 L216.....	380	MAO 10 L32.....	396				
CZFBV 25 L216.....	380	MAO 10 L40.....	396				
CZFBV 25 L216.....	380	MAO 10 X32.....	400				
CZFBV 25 L216.....	380	MAO 10 X40.....	400				
CZFBV 25 L216.....	380	MAO 10 YX32.....	607				
CZFBV 25 L216.....	380	MAO 10 YX40.....	607				

M

* These items are also shown in various sections throughout the catalogue

MAV 06 L32.....	389	MAVE 50.32.....	548	MFO 16.40.....	404	MFV 24 GYC32.....	614
MAV 06 LG25.....	390	MAVR 06 L32.....	586	MFO 24 G40.....	419	MFV 24 GYC40.....	614
MAV 06 LG32.....	390	MAVR 10.32.....	587	MFO 24 L32.....	415	MFV 24 L32.....	415
MAV 06 YX25.....	604	MAVR 16.40.....	588	MFO 24 L40.....	415	MFV 24 L40.....	415
MAV 06 YX32.....	604	MAVR 24.40.....	589	MFO 24 LG40.....	420	MFV 24 LG25.....	420
MAV 06LG25-F.....	388	MAVS 10.32.....	579	MFO 24.32.....	414	MFV 24 LG32.....	420
MAV 10 G25.....	398	MAVS 16.32.....	580	MFO 24.40.....	414	MFV 24 LG40.....	420
MAV 10 G32.....	398	MAVS 16.40.....	580	MFO 32 L40.....	426	MFV 24.232.....	416
MAV 10 GYC25.....	608	MAVS 24.32.....	581	MFO 32 X40.....	427	MFV 24.32.....	414
MAV 10 GYC32.....	608	MAVS 24.40.....	581	MFO 32.32.....	426	MFV 24.40.....	414
MAV 10 GYC40.....	608	MAVW 06 L32.....	521	MFO 32.40.....	426	MFV 32 G32.....	426
MAV 10 L32.....	396	MAVW 06 LG32.....	521	MFO 32.50.....	426	MFV 32 G40.....	426
MAV 10 L40.....	396	MAVW 10 G32.....	522	MFO 48 L32.....	430	MFV 32 G50.....	426
MAV 10 LG25.....	399	MAVW 10.32.....	522	MFO 48 L40.....	430	MFV 32 L40.....	426
MAV 10 LG32.....	399	MAVW 16 G32.....	523	MFO 48 L50.....	430	MFV 32 LG40.....	426
MAV 10 X32.....	400	MAVW 16.32.....	523	MFO 50 X25.....	433	MFV 32 X40.....	427
MAV 10 X40.....	400	MAVW 16.40.....	523	MFO 50 X32.....	433	MFV 32.32.....	426
MAV 10 YX32.....	607	MAVW 24.32.....	524	MFO 50.25.....	432	MFV 32.40.....	426
MAV 10 YX40.....	607	MAVW 24.40.....	524	MFO 50.32.....	432	MFV 32.50.....	426
MAV 10.220.....	397	MAVW 50.32.....	527	MFOE 06 L32M.....	531	MFV 48 L32.....	430
MAV 10.32.....	395	MBO 06 L40.....	466	MFOE 06 L40M.....	531	MFV 48 L40.....	430
MAV 10.40.....	395	MBO 06 L50.....	466	MFOE 10.32M.....	533	MFV 48 L50.....	430
MAV 16 G25.....	408	MBO 10.40.....	468	MFOE 10.40M.....	533	MFV 50 G32.....	432
MAV 16 G32.....	408	MBO 10.50.....	468	MFOE 16.32M.....	535	MFV 50 X25.....	433
MAV 16 G40.....	408	MBO 16.225.....	471	MFOE 16.40M.....	535	MFV 50 X32.....	433
MAV 16 GYC25.....	611	MBO 16.40.....	470	MFOE 24.32M.....	537	MFV 50.25.....	432
MAV 16 GYC32.....	611	MBO 16.50.....	470	MFOE 24.40M.....	537	MFV 50.32.....	432
MAV 16 GYC40.....	611	MBO 24.225.....	473	MFON 06 L25.....	618	MFVE 06 L32M.....	531
MAV 16 L32.....	405	MBO 24.40.....	472	MFON 10.32.....	620	MFVE 06 L40M.....	531
MAV 16 L40.....	405	MBO 24.50.....	472	MFON 16.32.....	622	MFVE 10.32M.....	533
MAV 16 LG25.....	409	MBV 06 L225.....	466	MFON 24.32.....	624	MFVE 10.40M.....	533
MAV 16 LG32.....	409	MBV 06 L320.....	466	MFOS 06 L32.....	578	MFVE 16.32M.....	535
MAV 16 LG40.....	409	MBV 06 L40.....	466	MFV 06 GYC25.....	605	MFVE 16.40M.....	535
MAV 16 X32.....	410	MBV 06 L50.....	466	MFV 06 GYC32.....	605	MFVE 24.32M.....	537
MAV 16 X40.....	410	MBV 10.225.....	468	MFV 06 GYC40.....	605	MFVE 24.40M.....	537
MAV 16 YX32.....	610	MBV 10.40.....	468	MFV 06 L25.....	389	MFVN 06 L25.....	618
MAV 16 YX40.....	610	MBV 10.420.....	468	MFV 06 L32.....	389	MFVN 06 LG25.....	619
MAV 16.220.....	406	MBV 10.50.....	468	MFV 06 L40.....	389	MFVN 10 G220.....	621
MAV 16.225.....	406	MBV 16.232.....	470	MFV 06 LG25.....	390	MFVN 10 G32.....	621
MAV 16.32.....	404	MBV 16.325.....	470	MFV 06 LG32.....	390	MFVN 10.32.....	620
MAV 16.40.....	404	MBV 16.40.....	470	MFV 06 LG40.....	390	MFVN 16 G225.....	623
MAV 24 G25.....	419	MBV 16.50.....	470	MFV 10 G25.....	398	MFVN 16 G32.....	623
MAV 24 G32.....	419	MBV 16.620.....	471	MFV 10 G32.....	398	MFVN 16.32.....	622
MAV 24 G40.....	419	MBV 24.240.....	472	MFV 10 G40.....	398	MFVN 24 G232.....	625
MAV 24 GYC25.....	614	MBV 24.332.....	472	MFV 10 GYC25.....	608	MFVN 24 G32.....	625
MAV 24 GYC32.....	614	MBV 24.40.....	472	MFV 10 GYC32.....	608	MFVN 24.32.....	624
MAV 24 GYC40.....	614	MBV 24.425.....	473	MFV 10 GYC40.....	608	MFVS 06 L32.....	578
MAV 24 L32.....	415	MBV 24.50.....	472	MFV 10 L32.....	396	MGK IAP20.....	628
MAV 24 L40.....	415	MBV 24.720.....	473	MFV 10 L40.....	396	MGK V20.....	629
MAV 24 LG25.....	420	MBVO 06 L240.....	467	MFV 10 LG25.....	399	MGK V20 B.....	631
MAV 24 LG32.....	420	MBVO 10.240.....	469	MFV 10 LG32.....	399	MGK V25.....	629
MAV 24 LG40.....	420	MBVO 16.240.....	471	MFV 10 LG40.....	399	MGK V25 B.....	631
MAV 24 X32.....	422	MBVO 24.250.....	473	MFV 10.220.....	397	MGO 06.25.....	633
MAV 24 X40.....	422	MFF 10.20.....	395	MFV 10.32.....	395	MGO 06.25 B.....	635
MAV 24 YX32.....	613	MFF 16.225.....	406	MFV 10.40.....	395	MGO 06.32.....	633
MAV 24 YX40.....	613	MFF 16.25.....	404	MFV 16 G25.....	408	MGO 06.32 B.....	635
MAV 24.232.....	416	MFF 24.225.....	416	MFV 16 G32.....	408	MGO 10.25.....	637
MAV 24.32.....	414	MFF 24.25.....	414	MFV 16 G40.....	408	MGO 10.25 B.....	639
MAV 24.40.....	414	MFF 24.32.....	414	MFV 16 GYC25.....	611	MGO 10.32.....	637
MAV 50 G32.....	432	MFO 06 L25.....	389	MFV 16 GYC32.....	611	MGO 10.32 B.....	639
MAV 50 X25.....	433	MFO 06 L32.....	389	MFV 16 GYC40.....	611	MGO 16.32.....	641
MAV 50 X32.....	433	MFO 06 L40.....	389	MFV 16 L32.....	405	MGO 16.32 B.....	643
MAV 50.25.....	432	MFO 06 LG40.....	390	MFV 16 L40.....	405	MGO 16.40.....	641
MAV 50.32.....	432	MFO 10 G40.....	398	MFV 16 LG25.....	409	MGO 16.40 B.....	643
MAVE 06 L32.....	542	MFO 10 L32.....	396	MFV 16 LG32.....	409	MGO 16.50.....	641
MAVE 06 LG32.....	542	MFO 10 L40.....	396	MFV 16 LG40.....	409	MGO 16.50 B.....	643
MAVE 10 G32.....	543	MFO 10 LG40.....	399	MFV 16.220.....	406	MGO 24.32.....	645
MAVE 10.32.....	543	MFO 10.32.....	395	MFV 16.225.....	406	MGO 24.32 B.....	647
MAVE 16 G32.....	544	MFO 10.40.....	395	MFV 16.32.....	404	MGO 24.40.....	645
MAVE 16.32.....	544	MFO 16 G40.....	408	MFV 16.40.....	404	MGO 24.40 B.....	647
MAVE 16.40.....	544	MFO 16 L32.....	405	MFV 24 G25.....	419	MGO 24.50.....	645
MAVE 24 G32.....	545	MFO 16 L40.....	405	MFV 24 G32.....	419	MGO 24.50 B.....	647
MAVE 24.32.....	545	MFO 16 LG40.....	409	MFV 24 G40.....	419	MGOE 06.25.....	551
MAVE 24.40.....	545	MFO 16.32.....	404	MFV 24 GYC25.....	614	MGOE 06.32.....	551

* These items are also shown in various sections throughout the catalogue

MGOE 10.25.....	553	MHO 10 L25.....	396	MHP 10 L20.....	394	MHV 10.25.....	395
MGOE 10.32.....	553	MHO 10 X20.....	400	MHP 10 L220.....	394	MHV 16 G32.....	408
MGOE 16.32.....	555	MHO 10 X25.....	400	MHP 10 LS20.....	394	MHV 16 L25.....	405
MGOE 16.40.....	555	MHO 10.20.....	395	MHP 10 LS220.....	394	MHV 16 L32.....	405
MGOE 16.50.....	555	MHO 10.25.....	395	MHP 10.20.....	394	MHV 16 LG32.....	409
MGOE 24.32.....	557	MHO 16 L25.....	405	MHP 10.220.....	394	MHV 16 X25.....	410
MGOE 24.40.....	557	MHO 16 L32.....	405	MHP 16 CP225.....	403	MHV 16 X32.....	410
MGOE 24.50.....	557	MHO 16 X25.....	410	MHP 16 CP25.....	403	MHV 16.25.....	404
MGP 06.32.....	632	MHO 16 X32.....	410	MHP 16 CS225.....	403	MHV 16.32.....	404
MGP 10.32.....	636	MHO 16.25.....	404	MHP 16 CS25.....	403	MHV 24 G32.....	419
MGP 16.40.....	640	MHO 16.32.....	404	MHP 16 L225.....	403	MHV 24 L25.....	415
MGP 24.240.....	644	MHO 24 L25.....	415	MHP 16 L25.....	403	MHV 24 L32.....	415
MGP 24.40.....	644	MHO 24 L32.....	415	MHP 16 LS225.....	403	MHV 24 L40.....	415
MGPE 06.32.....	550	MHO 24 X25.....	422	MHP 16 LS25.....	403	MHV 24 LG32.....	420
MGPE 10.32.....	552	MHO 24 X32.....	422	MHP 16.225.....	403	MHV 24 X25.....	422
MGPE 16.40.....	554	MHO 24.25.....	414	MHP 16.25.....	403	MHV 24 X32.....	422
MGPE 24.240.....	556	MHO 24.32.....	414	MHP 24 CP225.....	413	MHV 24.25.....	414
MGPE 24.40.....	556	MHO 32 L40.....	426	MHP 24 CP25.....	413	MHV 24.32.....	414
MGV 06.25.....	633	MHO 32 X40.....	427	MHP 24 CS225.....	413	MHV 24.40.....	414
MGV 06.25 B.....	635	MHO 32.32.....	426	MHP 24 CS25.....	413	MHV 32 G32.....	426
MGV 06.32.....	633	MHO 32.40.....	426	MHP 24 L225.....	413	MHV 32 G40.....	426
MGV 06.32 B.....	635	MHO 32.50.....	426	MHP 24 L25.....	413	MHV 32 G50.....	426
MGV 06.40.....	633	MHO 48 L32.....	430	MHP 24 LS225.....	413	MHV 32 L40.....	426
MGV 06.40 B.....	635	MHO 48 L40.....	430	MHP 24 LS25.....	413	MHV 32 LG40.....	426
MGV 10.25.....	637	MHO 48 L50.....	430	MHP 24.225.....	413	MHV 32 X40.....	427
MGV 10.25 B.....	639	MHO 50 X25.....	433	MHP 24.25.....	413	MHV 32.32.....	426
MGV 10.32.....	637	MHO 50 X32.....	433	MHP 32 L240.....	425	MHV 32.40.....	426
MGV 10.32 B.....	639	MHO 50.25.....	432	MHP 32 L250.....	425	MHV 32.50.....	426
MGV 10.40.....	637	MHO 50.32.....	432	MHP 32 L40.....	425	MHV 48 L32.....	430
MGV 10.40 B.....	639	MHOE 06 L20M.....	531	MHP 32 L50.....	425	MHV 48 L40.....	430
MGV 16.225.....	641	MHOE 06 L25M.....	531	MHP 32 LS240.....	425	MHV 48 L50.....	430
MGV 16.225 B.....	643	MHOE 10.20M.....	533	MHP 32 LS250.....	425	MHVE 06 L20M.....	531
MGV 16.25.....	641	MHOE 10.25M.....	533	MHP 32 LS40.....	425	MHVE 06 L25M.....	531
MGV 16.25 B.....	643	MHOE 16.25.....	544	MHP 32 LS50.....	425	MHVE 10.20M.....	533
MGV 16.32.....	641	MHOE 16.25M.....	535	MHP 32.240.....	425	MHVE 10.25M.....	533
MGV 16.32 B.....	643	MHOE 16.32.....	544	MHP 32.250.....	425	MHVE 16.2.....	544
MGV 16.40.....	641	MHOE 16.32M.....	535	MHP 32.40.....	425	MHVE 16.25M.....	535
MGV 16.40 B.....	643	MHOE 24.25.....	545	MHP 32.50.....	425	MHVE 16.32.....	544
MGV 16.50.....	641	MHOE 24.25M.....	537	MHP 48 LS40.....	430	MHVE 16.32M.....	535
MGV 16.50 B.....	643	MHOE 24.32.....	545	MHP 48 LS50.....	430	MHVE 24.25.....	545
MGV 24.232.....	645	MHOE 24.32M.....	537	MHP 50 CS232.....	431	MHVE 24.25M.....	537
MGV 24.232 B.....	647	MHOE 32.40.....	546	MHP 50 CS240.....	431	MHVE 24.32.....	545
MGV 24.240.....	645	MHOE 48 L40.....	547	MHP 50 CS32.....	431	MHVE 24.32M.....	537
MGV 24.240 B.....	647	MHOE 50.25.....	548	MHP 50 CS40.....	431	MHVE 24.40M.....	537
MGV 24.32.....	645	MHOE 50.32.....	548	MHP 50.232.....	431	MHVE 32 G40.....	546
MGV 24.32 B.....	647	MHON 06 L25.....	618	MHP 50.240.....	431	MHVE 32.40.....	546
MGV 24.325.....	645	MHON 10.25.....	620	MHP 50.32.....	431	MHVE 48 L40.....	547
MGV 24.325 B.....	647	MHON 16.32.....	622	MHP 50.40.....	431	MHVN 06 L25.....	618
MGV 24.40.....	645	MHON 24.32.....	624	MHPE 32.50.....	546	MHVN 06 LG25.....	619
MGV 24.40 B.....	647	MHOR 06 L20.....	586	MHPE 48 LS40.....	547	MHVN 10 G25.....	621
MGV 24.50.....	645	MHOR 10.20.....	587	MHPE 50.240.....	548	MHVN 10.25.....	620
MGV 24.50 B.....	647	MHOR 16.25.....	588	MHPE 50.32.....	548	MHVN 16 G32.....	623
MGVE 06.25.....	551	MHOR 24.25.....	589	MHPR 10.20.....	587	MHVN 16.32.....	622
MGVE 06.32.....	551	MHOR 48 L40.....	590	MHPR 48 LS40.....	590	MHVN 24 G32.....	625
MGVE 06.40.....	551	MHOS 16.25.....	580	MHPW 32.50.....	525	MHVN 24.32.....	624
MGVE 10.25.....	553	MHOS 16.32.....	580	MHPW 48 LS40.....	526	MHVR 06 L20.....	586
MGVE 10.32.....	553	MHOS 24.25.....	581	MHPW 50.240.....	527	MHVR 10.20.....	587
MGVE 10.40.....	553	MHOS 24.32.....	581	MHPW 50.32.....	527	MHVR 16.25.....	588
MGVE 16.225.....	555	MHOW 16.25.....	523	MHPX 32 L40.....	429	MHVR 24.25.....	589
MGVE 16.25.....	555	MHOW 16.32.....	523	MHPX 32 LP40.....	429	MHVR 48 L40.....	590
MGVE 16.32.....	555	MHOW 24.25.....	524	MHPX 32 LP50.....	429	MHVS 16.25.....	580
MGVE 16.40.....	555	MHOW 24.32.....	524	MHPX 32 LS40.....	429	MHVS 16.32.....	580
MGVE 16.50.....	555	MHOW 32.40.....	525	MHV 06 L20.....	389	MHVS 24.25.....	581
MGVE 24.232.....	557	MHOW 48 L40.....	526	MHV 06 L25.....	389	MHVS 24.32.....	581
MGVE 24.240.....	557	MHOW 50.25.....	527	MHV 06 LG25.....	390	MHVW 16.25.....	523
MGVE 24.32.....	557	MHOW 50.32.....	527	MHV 06 LX20.....	391	MHVW 16.32.....	523
MGVE 24.325.....	557	MHP 06 L20.....	388	MHV 06 LX25.....	391	MHVW 24 G32.....	524
MGVE 24.40.....	557	MHP 06 L220.....	388	MHV 10 G25.....	398	MHVW 24.25.....	524
MGVE 24.50.....	557	MHP 06 LS20.....	388	MHV 10 L20.....	396	MHVW 24.32.....	524
MHO 06 L20.....	389	MHP 06 LS220.....	388	MHV 10 L25.....	396	MHVW 32 G40.....	525
MHO 06 L25.....	389	MHP 10 CP20.....	394	MHV 10 LG25.....	399	MHVW 32.40.....	525
MHO 06 LX20.....	391	MHP 10 CP220.....	394	MHV 10 X20.....	400	MHVW 48 L40.....	526
MHO 06 LX25.....	391	MHP 10 CS20.....	394	MHV 10 X25.....	400	MIO 16.40.....	407
MHO 10 L20.....	396	MHP 10 CS220.....	394	MHV 10.20.....	395	MIO 16.50.....	407

* These items are also shown in various sections throughout the catalogue

MIO 24 YX40.....	613	MKAXS IVG20.....	570	MVAP 24 L232.....	461	MVV 16 G32.....	458
MIO 24 YX50.....	613	MKAXS VG20.....	564	MVAP 24 L240.....	461	MVV 16 LG32.....	458
MIO 24.40.....	417	MKAXS VG25.....	572	MVAP 24 L32.....	461	MVV 24 G32.....	463
MIO 24.50.....	417	MKAXW AP20.....	512	MVAP 24 L40.....	461	MVV 24 LG32.....	463
MIV 16.40.....	407	MKAXW AP25.....	514	MVAP 24 LP32.....	462	MXA 01 O25.....	369
MIV 24 YX40.....	613	MKAXW IAP20.....	512	MVAP 24 LP40.....	462	MXA 01 V25.....	369
MIV 24 YX50.....	613	MKAXW IAP25.....	514	MVAP 24 LS32.....	462	MXA 01 V32.....	369
MIV 24.40.....	417	MKAXW IF.....	516	MVAP 24 LS40.....	462	MZ7P 15 L225.....	384
MIV 24.50.....	417	MKAXW VG20.....	512	MVAP 24LP232.....	462	MZ7P 15 L25.....	384
MK IAP20.....	339	MKAXW VG25.....	518	MVAP 24LP240.....	462	MZ7P 15 LS25.....	384
MK IAPN20.....	339	MKAXX AP25.....	359	MVAP 24LS232.....	462	MZ7P 15LS225.....	384
MK V20.....	340	MKAXX IAP25.....	359	MVAP 24LS240.....	462	MZ7P 25 L225.....	385
MK V25.....	341	MKAXX IF.....	363	MVAP 24LSP25.....	460	MZ7P 25 L25.....	385
MK VA20.....	340	MKAXX VG25.....	361	MVAP 24LSP32.....	460	MZ7P 25 LS25.....	385
MK VAN20.....	340	MKAXXR IF.....	585	MVAP 24LSP40.....	460	MZ7P 25LS225.....	385
MK VG20.....	340	MKAXXS AP25.....	567	MVAV 06 LG25.....	447	MZ7PE 15L225.....	540
MK VG25.....	342	MKAXXS IAP25.....	567	MVAV 06 LG32.....	447	MZ7PE 25L225.....	541
MK VGN20.....	340	MKAXXS IF.....	569	MVAV 10 G25.....	453	MZ7PS 15L225.....	576
MK VGN25.....	343	MKAXXS IVG20.....	571	MVAV 10 G32.....	453	MZ7PS 25L225.....	577
MK VN20.....	340	MKAXXS VG25.....	572	MVAV 10 LG25.....	453	MZ7PW 15L225.....	519
MK VN25.....	341	MKAXXW AP25.....	515	MVAV 10 LG32.....	453	MZ7PW 25L225.....	520
MKA AP20.....	349	MKAXXW IAP25.....	515	MVAV 16 G25.....	458	MZAO 15 L20.....	376
MKA AP25.....	359	MKAXXW IF.....	517	MVAV 16 G32.....	458	MZAO 15 L25.....	376
MKA IAF20.....	350	MKAXXW VG25.....	518	MVAV 16 LG25.....	458	MZAO 25 L20.....	380
MKA IAF25.....	350	MKG V20.....	347	MVAV 16 LG32.....	458	MZAO 25 L25.....	380
MKA IAP20.....	349	MKG V25.....	348	MVAV 24 G25.....	463	MZAOE 15 L25.....	540
MKA IAP25.....	359	MKG VA20.....	347	MVAV 24 G32.....	463	MZAOE 25 L25.....	541
MKA IF.....	363	MKG VAN20.....	347	MVAV 24 LG25.....	463	MZAOV 15 L25.....	519
MKA V20.....	351	MKG VN20.....	347	MVAV 24 LG32.....	463	MZAOV 25 L25.....	520
MKA V25.....	352	MKG VN25.....	348	MVAV 24 LG32.....	463	MZAP 25 L225.....	378
MKA VA20.....	351	MQ 08 VO225.....	366	MVAV 24 G25.....	463	MZAP 25 L25.....	378
MKA VG20.....	351	MQO 24.40.....	418	MVAV 24 LG25.....	463	MZAP 25 LS25.....	378
MKA VG25.....	361	MVAP 06 LP32.....	446	MVAV 24 LG32.....	463	MZAP 25LS225.....	378
MKAE V20.....	538	MVAP 06 LP40.....	446	MVAV 24 G25.....	463	MZAP 25LSP20.....	379
MKAE VA20.....	538	MVAP 06 LS32.....	446	MVAV 24 G32.....	463	MZAP 25LSP25.....	379
MKAG V20.....	354	MVAP 06 LS40.....	446	MVAV 16 G25.....	458	MZAPR 06 L32.....	586
MKAG V25.....	355	MVAP 06LP232.....	446	MVAV 16 G32.....	458	MZAV 15 L20.....	376
MKAG VA20.....	354	MVAP 06LP240.....	446	MVAV 16 LG25.....	458	MZAV 15 L25.....	376
MKAR V20.....	583	MVAP 06LSP240.....	446	MVAV 16 LG32.....	458	MZAV 25 L20.....	380
MKAR VA20.....	583	MVAP 06LS232.....	446	MVAV 16 LG32.....	458	MZAV 25 L20.....	380
MKAS AP25.....	567	MVAP 06LS240.....	446	MVAV 24 G25.....	463	MZAV 25 L220.....	380
MKAS IAP25.....	567	MVAP 06LSP25.....	445	MVAV 24 G32.....	463	MZAV 25 L25.....	380
MKAS IF.....	569	MVAP 06LSP32.....	445	MVAV 24 LG25.....	463	MZAVE 15 L25.....	540
MKAS IVG20.....	571	MVAP 06LSP40.....	445	MVAV 24 LG32.....	463	MZAVE 25 L25.....	541
MKAS V20.....	564	MVAP 10 L232.....	451	MVI 10 LAP32.....	450	MZAVV 15 L25.....	519
MKAS V25.....	564	MVAP 10 L240.....	451	MVP 06 LP20.....	446	MZAVV 25 L25.....	520
MKAS VA20.....	564	MVAP 10 L32.....	451	MVP 06 LP220.....	446	MZFO 15 L20.....	376
MKAS VG25.....	572	MVAP 10 L40.....	451	MVP 06 LS20.....	446	MZFO 15 L25.....	376
MKAW V20.....	512	MVAP 10 LP32.....	452	MVP 06 LS220.....	446	MZFO 25 L20.....	380
MKAW V25.....	512	MVAP 10 LP40.....	452	MVP 06 LSP20.....	445	MZFO 25 L25.....	380
MKAW VA20.....	512	MVAP 10 LS32.....	452	MVP 10 L20.....	451	MZFOS 05 L25.....	576
MKAX AP20.....	349	MVAP 10 LS40.....	452	MVP 10 L220.....	451	MZFOS 25 L25.....	577
MKAX AP25.....	358	MVAP 10LP232.....	452	MVP 10 LP20.....	452	MZFO 25 L20.....	380
MKAX IAF20.....	350	MVAP 10LP240.....	452	MVP 10 LP220.....	452	MZFO 25 L25.....	380
MKAX IAF25.....	350	MVAP 10LS232.....	452	MVP 10 LP220.....	452	MZFV 15 L20.....	376
MKAX IAP20.....	349	MVAP 10LS240.....	452	MVP 10 LS20.....	452	MZFV 15 L25.....	376
MKAX IAP25.....	358	MVAP 10LSP25.....	449	MVP 10 LS220.....	452	MZFV 25 L20.....	380
MKAX IF.....	362	MVAP 10LSP32.....	449	MVP 10 LSP20.....	449	MZFV 25 L220.....	380
MKAX VG20.....	351	MVAP 10LSP40.....	449	MVP 10 LSP25.....	449	MZFV 25 L25.....	380
MKAX VG25.....	360	MVAP 16 L232.....	456	MVP 16 L225.....	456	MZFVS 15 L25.....	576
MKAXE AP20.....	538	MVAP 16 L240.....	456	MVP 16 L25.....	456	MZFVS 25 L25.....	577
MKAXE IAF20.....	539	MVAP 16 L32.....	456	MVP 16 LP225.....	457	MZO 15 L20.....	376
MKAXE IAF25.....	539	MVAP 16 L40.....	456	MVP 16 LP25.....	457	MZO 15 L25.....	376
MKAXE IAP20.....	538	MVAP 16 LP32.....	457	MVP 16 LP25.....	457	MZO 25 L20.....	380
MKAXE VG20.....	538	MVAP 16 LP40.....	457	MVP 16 LS225.....	457	MZO 25 L25.....	380
MKAXR AP20.....	583	MVAP 16 LS32.....	457	MVP 16 LS25.....	457	MZOE 15 L20.....	540
MKAXR IAP20.....	583	MVAP 16 LS40.....	457	MVP 16 LSP25.....	455	MZOE 15 L25.....	540
MKAXR IF.....	584	MVAP 16LP232.....	457	MVP 24 L225.....	461	MZOE 25 L20.....	541
MKAXR VG20.....	583	MVAP 16LP240.....	457	MVP 24 L25.....	461	MZOE 25 L25.....	541
MKAXS AP20.....	564	MVAP 16LS232.....	457	MVP 24 LP225.....	462	MZOS 15 L20.....	576
MKAXS AP25.....	566	MVAP 16LS240.....	457	MVP 24 LP25.....	462	MZOS 15 L25.....	576
MKAXS IAP20.....	564	MVAP 16LSP25.....	455	MVP 24 LS225.....	462	MZOS 25 L20.....	577
MKAXS IAP25.....	566	MVAP 16LSP32.....	455	MVP 24 LS25.....	462	MZOS 25 L25.....	577
MKAXS IF.....	568	MVAP 16LSP40.....	455	MVP 24 LSP25.....	460	MZOW 15 L20.....	519
				MVV 06 LG25.....	447	MZOW 15 L25.....	519
				MVV 10 G25.....	453	MZOW 25 L20.....	520
				MVV 10 LG25.....	453	MZOW 25 L25.....	520

* These items are also shown in various sections throughout the catalogue

MZP 15 L225	374
MZP 15 L25	374
MZP 15 LS225	374
MZP 15 LS25	374
MZP 15 LSP20	375
MZP 15 LSP25	375
MZPR 06 L20	586
MZV 15 L20	376
MZV 15 LG20	376
MZV 25 L20	380
MZV 25 LG20	381
MZVE 15 L20	540
MZVE 25 L20	541
MZVS 15 L20	576
MZVS 25 L20	577
MZVW 15 L20	519
MZVW 25 L20	520

R

RAC 06 L	600
RAC 10 L	600
RAC 16 L	600
RAC 24 L	600
RCEF 06	214
RCEF 10	215
RCEF 16	216
RCEF 24	217
RCEM 06	214
RCEM 10	215
RCEM 16	216
RCEM 24	217
RCF2D 0.3	214*
RCF2D 0.5	214*
RCF2D 0.7	214*
RCF2D 1.0	214*
RCF2D 1.5	214*
RCF2D 2.5	214*
RCF2D 3.0	214*
RCF2D 4.0	214*
RCM2D 0.3	214*
RCM2D 0.5	214*
RCM2D 0.7	214*
RCM2D 1.0	214*
RCM2D 1.5	214*
RCM2D 2.5	214*
RCM2D 3.0	214*
RCM2D 4.0	214*
RDDF 108	213
RDDF 24	210
RDDF 42	211
RDDF 72	212
RDDM 108	213
RDDM 24	210
RDDM 42	211
RDDM 72	212
RDF 40	208
RDF 64	209
RDF2D 0.3	208*
RDF2D 0.5	208*
RDF2D 0.7	208*
RDF2D 1.0	208*
RDF2D 1.5	208*
RDF2D 2.5	208*
RDM 40	208
RDM 64	209
RDM2D 0.3	208*
RDM2D 0.5	208*
RDM2D 0.7	208*
RDM2D 1.0	208*
RDM2D 1.5	208*
RDM2D 2.5	208*
RFO 06 L32	593
RFO 10 L32	595

RFO 16 L32	597
RFO 24 L40	599
RFV 06 L32	593
RFV 10 L32	595
RFV 16 L32	597
RFV 24 L40	599
RHO 06 L25	593
RHO 10 L25	595
RHO 16 L32	597
RHO 24 L32	599
RHV 06 L25	593
RHV 10 L25	595
RHV 16 L32	597
RHV 24 L32	599
RQEEF 40	218
RQEEF 64	219
RQEEM 40	218
RQEEM 64	219
RVAP 06 L232	592
RVAP 06 L32	592
RVAP 10 L232	594
RVAP 10 L32	594
RVAP 16 L232	596
RVAP 16 L32	596
RVAP 24 L232	598
RVAP 24 L32	598
RVI 06 L	592
RVI 10 L	594
RVI 16 L	596
RVI 24 L	598
RVP 06 L20	592
RVP 06 L220	592
RVP 10 L20	594
RVP 10 L220	594
RVP 16 L225	596
RVP 16 L25	596
RVP 24 L225	598
RVP 24 L25	598
RX 02 TF	333
RX 02 TM	333
RX 03 TF	333
RX 03 TM	333
RX 04 TF	333
RX 04 TM	333
RX 06 TF	333
RX 06 TM	333
RXF 12/2	221
RXF2D 1.5	221*
RXF2D 10	321, 323
RXF2D 2.5	221*
RXF2D 4.0	221*
RXF2D 6.0	221*
RXM 12/2	221
RXM2D 1.5	221*
RXM2D 10	321, 323
RXM2D 2.5	221*
RXM2D 4.0	221*
RXM2D 6.0	221*

S

SDS	701
-----	-----

T

TAPC 06 L25	506
TAPC 06 L32	506
TAPC 10.25	507
TAPC 10.32	507
TAPC 16.32	508
TAPC 16.40	508
TAPC 24.32	509
TAPC 24.40	509
TAPH 06 L25	501

TAPH 06 L32	501
TAPH 10.25	502
TAPH 10.32	502
TAPH 16.32	503
TAPH 16.40	503
TAPH 24.32	504
TAPH 24.40	504
TAPW 06 L25	489
TAPW 06 L32	489
TAPW 10.25	490
TAPW 10.32	490
TAPW 16.32	491
TAPW 16.40	491
TAPW 24.32	492
TAPW 24.40	492
TAVC 06 LG25	506
TAVC 06 LG32	506
TAVC 10 G25	507
TAVC 10 G32	507
TAVC 16 G32	508
TAVC 16 G40	508
TAVC 24 G32	509
TAVC 24 G40	509
TAVH 06 LG25	501
TAVH 06 LG32	501
TAVH 10 G25	502
TAVH 10 G32	502
TAVH 16 G32	503
TAVH 16 G40	503
TAVH 24 G32	504
TAVH 24 G40	504
TAVW 06 LG25	489
TAVW 06 LG32	489
TAVW 10 G25	490
TAVW 10 G32	490
TAVW 16 G32	491
TAVW 16 G40	491
TAVW 24 G32	492
TAVW 24 G40	492
TCHC 06 L	481
TCHC 06 LG	481
TCHC 06 SL	481
TCHC 10	483
TCHC 10 G	483
TCHC 10 S	483
TCHC 16	485
TCHC 16 G	485
TCHC 16 S	485
TCHC 24	487
TCHC 24 G	487
TCHC 24 S	487
TCHI 06 L	480
TCHI 10	482
TCHI 16	484
TCHI 24	486
THCC 06 LG	506
THCC 10 G	507
THCC 16 G	508
THCC 24 G	509
THCH 06 LG	501
THCH 10 G	502
THCH 16 G	503
THCH 24 G	504
THCW 06 LG	489
THCW 10 G	490
THCW 16 G	491
THCW 24 G	492
THIC 06 L	506
THIC 10	507
THIC 16	508
THIC 24	509
THIH 06 L	501
THIH 10	502
THIH 16	503

THIH 24	504
THIW 06 L	489
THIW 10	490
THIW 16	491
THIW 24	492
TM BLC125	666
TMAO 06 L25	480
TMAO 06 L32	480
TMAO 10.25	482
TMAO 10.32	482
TMAO 16.32	484
TMAO 16.40	484
TMAO 24.32	486
TMAO 24.40	486
TMAP 06 L25	480
TMAP 06 L32	480
TMAP 10.25	482
TMAP 10.32	482
TMAP 16.32	484
TMAP 16.40	484
TMAP 24.32	486
TMAP 24.40	486
TMAV 06 L25	480
TMAV 06 L32	480
TMAV 06 LG25	481
TMAV 06 LG32	481
TMAV 10 G25	483
TMAV 10 G32	483
TMAV 10.25	482
TMAV 10.32	482
TMAV 16 G32	485
TMAV 16 G40	485
TMAV 16.32	484
TMAV 16.40	484
TMAV 24 G32	487
TMAV 24 G40	487
TMAV 24.32	486
TMAV 24.40	486

Z

ZFU-CD	728
--------	-----

* These items are also shown in various sections throughout the catalogue

Worldwide Sales Organization

Headquarters

ILME S.p.A.

Via M.A. Colonna, 9
20149 Milano, Italia
T +39 0234560522
info@ilme.com

France

ILME FRANCE S.A.R.L.

431 rue Roland Garros
Parc d'Activités de l'Aéroport
42160 Andrézieux-Bouthéon
T +33 04 7736 2336
ilme-france@ilme.fr

Sweden and Nordic Countries

ILME NORDIC AB

Transportvägen 18
246 42 Löddeköpinge
T +46 4618 2800
info@ilme.se

Czech Republic Representative Office

ILME S.p.A.

Business Center Rokytká
Sokolovská 270/201
Vysocany, Praha 9, 190 00
info@ilme.cz

Japan

ILME JAPAN CO. LTD.

K.I.B.C. Bldg 5-2
Minatojima Minamimachi 5-Chome
Chuo-Ku, Kobe 650-0047
T +81 78 302 2005
info@ilmejapan.co.jp

Germany

ILME GmbH

Max-Planck-Straße 12
51674 Wiehl
T +49 (0)2261 7955 0
technik@ilme.de

United Kingdom

ILME UK LIMITED

50 Evans Road, Venture Point
Speke, Liverpool L24 9PB
T +44 0151 336 9321
sales@ilmeuk.co.uk

China

ILME CHINA CO. LTD.

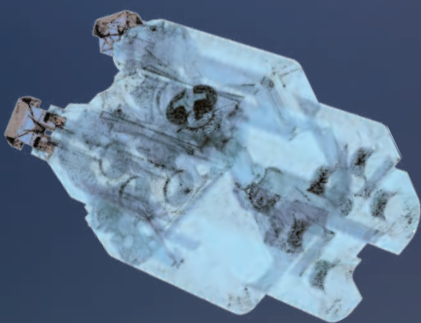
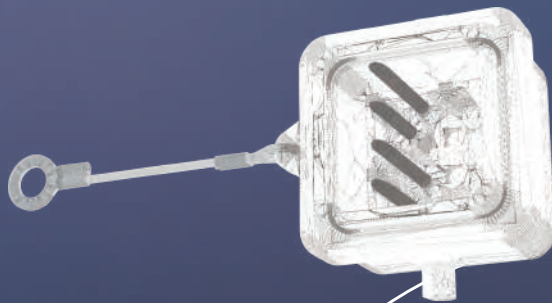
Room 101, Building 3
188 Xinjunhuan Road, Minhang
Shanghai 201114
T +86 21 6248 9961
info@ilmechina.com

South Korea

ILME KOREA CO.

714, DaeRyung Technotown 20th
5 Gasan Digital 1-Ro, GeumCheon-Gu
Seoul 08594
T +82-2-2225-8432
sales@ilme.kr

www.ilme.com



ILME S.p.A.
Via M.A. Colonna 9
20149 Milano, Italy
www.ilme.com

