

Smart relays Zelio Logic

Catalogue

October 2011





All technical information about products listed in this catalogue are now available on:

www.schneider-electric.com

Browse the “product data sheet” to check out :

- characteristics,
- dimensions,
- curves, ...
- and also the links to the user guides and the CAD files.

1 From the home page, type the model number* into the “Search” box.



* type the model number without any blank, replace “.” by “*”

2 Under “All” tab, click the model number that interests you.

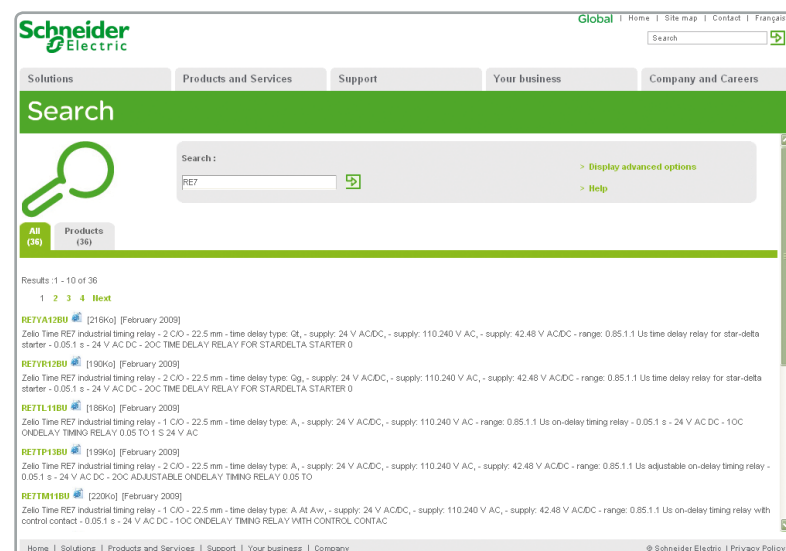

3 The product data sheet displays.

Example : Zelio Time data sheet

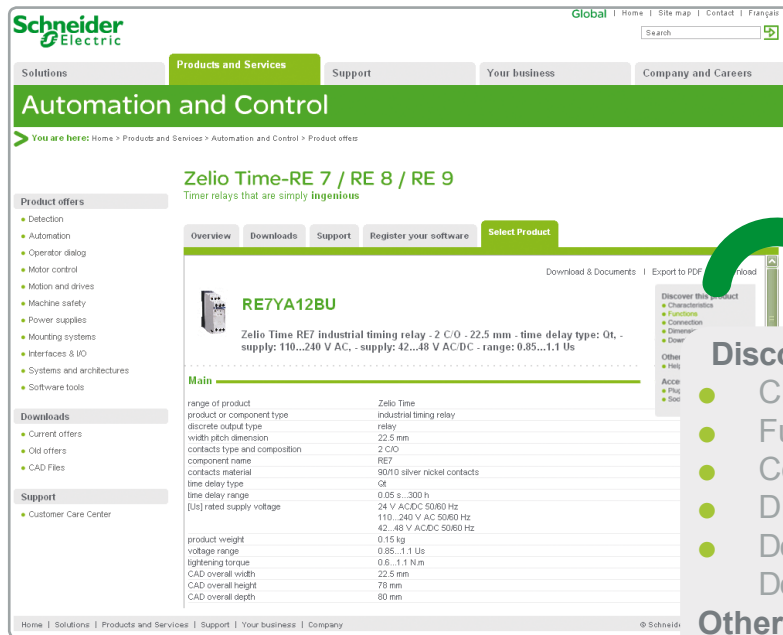

Discover this product

- Characteristics
- Functions
- Connection
- Dimensions
- Download & Documents

Other products

- Help me to choose
- Accessories**
- Plug
- Sockets

Example : Zelio Time data sheet

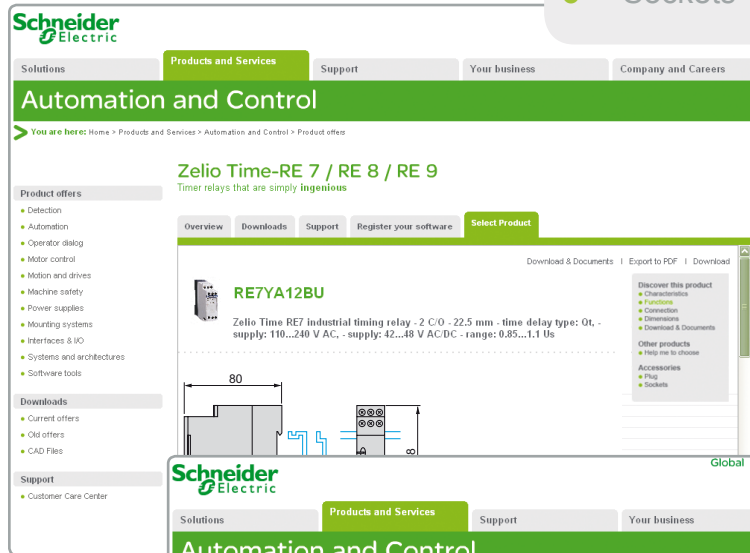

Example : Zelio Time data sheet

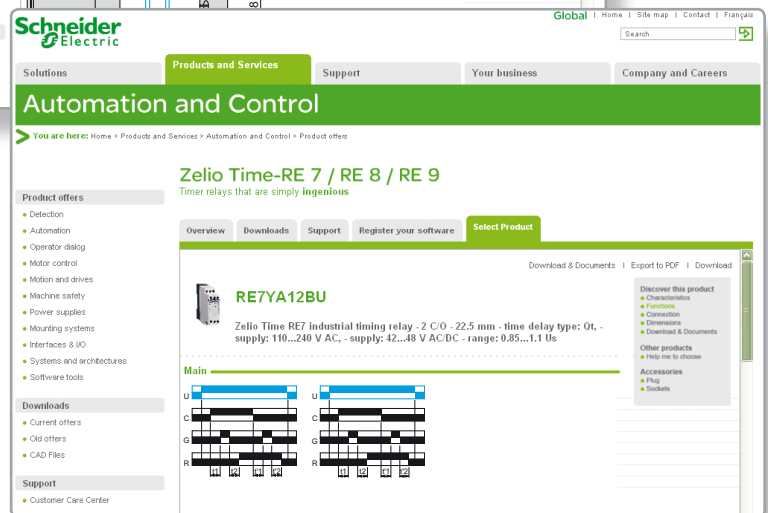

You can get this information in one single pdf file.

Selection guide **pages 4 to 7**

- **Compact and modular smart relays**
 - Presentation pages 8 to 11
 - Functions pages 12 to 14
 - Description page 15
 - References pages 16 to 21
- **Communication**
 - Presentation page 22
- **Programming protocol**
 - Description page 23
- **Modbus slave communication protocol**
 - Presentation page 24
 - Description page 25
 - Functions page 26
- **Ethernet server communication protocol**
 - Presentation, description page 27
 - Functions page 28
- **Communication**
 - References page 29
- **Analogue I/O extension modules**
 - Presentation, description page 30
 - References pages 31
- **Modem communication interface**
 - Presentation, description pages 32 and 33
 - Functions, setting-up pages 34 and 35
 - References pages 36 and 37
- **Analogue interfaces**
 - Presentation pages 40 and 41
 - References pages 42 and 43
- **Powers supplies and transformers**
 - Presentation, description page 44
 - References page 45



~ 100...240 V			= 12 V		= 24 V			
10	12	20	12	20	10	12	20	
6 (0)	8 (0)	12 (0)	8 (4)	12 (6)	6 (0)	8 (4)	12 (2), 12 (6)	
4/0	4/0	8/0	4/0	8/0	4/0	4/0, 0/4	8/0, 0/8	
SR2 B●●●1FU FBD (1) or LADDER			SR2 B●●1JD FBD (1) or LADDER			SR2 B●●●BD FBD (1) or LADDER		
SR2 A●●●1FU LADDER only			–			SR2 A●●●BD LADDER only		
SR2 E●●●1FU FBD (1) or LADDER			–			SR2 E●●●BD FBD (1) or LADDER		
SR2 D●●●1FU LADDER only			–			SR2 D●●●BD LADDER only		
SR2 PACK●FU			–		SR2 PACK●BD			
SR2 COM01 (for SR2 B and SR2 E)			SR2 COM01		SR2 COM01 (for SR2 B and SR2 E)			
SR2 MOD0●			SR2 MOD0●		SR2 MOD0●			
"Zelio Logic Alarm" SR2 SFT02			"Zelio Logic Alarm" SR2 SFT02		"Zelio Logic Alarm" SR2 SFT02			
–			RM●●●●BD					
–			ABL 8MEM12020		ABL 8MEM240●● ABL 7RM24025			
SR2 ●●●1FU			SR2 B●●1JD		SR2 ●●●●BD			
16 and 17			16		16 and 17			



More technical information on www.schneider-electric.com



12 V

26
16 (6)
10/0

24 V

10	26
6 (4)	16 (6)
4/0, 0/4	10/0, 0/10

SR3 PACK●BD

RM●●●BD

ABL 8MEM12020

ABL 8MEM24006, ABL 8MEM24012, ABL 7RM24025

SR3 B261JD

SR3 B●●●BD

Discrete I/O extension modules

Network communication modules
Modbus slave Ethernet server

I/O extension modules
Analogue Discrete



6	10	14
4 (0)	6 (0)	8 (0)
2 (0)	4 (0)	6 (0)

■ Number of words:	■ Number of words:
<input type="checkbox"/> 4 (inputs)	<input type="checkbox"/> 4 (inputs)
<input type="checkbox"/> 4 (outputs)	<input type="checkbox"/> 4 (outputs)
<input type="checkbox"/> 4 (clock)	<input type="checkbox"/> 4 (clock)
<input type="checkbox"/> 1 (status)	<input type="checkbox"/> 1 (status)

4	6	10	14
0 (2)	4 (0)	6 (0)	8 (0)
0 (2)	2 (0)	4 (0)	6 (0)

SR3 XT●●●JD

SR3 MBU01BD SR3 NET01BD

SR3 XT43BD

SR3 XT●●●BD

19

29

31

19



Zelio Logic compact smart relay

Combination of modular smart relays with communication and I/O extension modules



- 1 Zelio Logic modular smart relay (10 or 26 I/O)
- 2 I/O extension module: discrete (6, 10 or 14 I/O) or analogue (4 I/O)

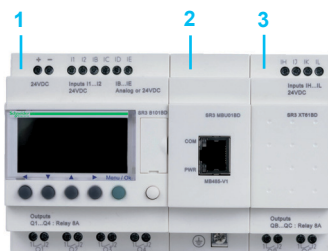

- 1 Zelio Logic modular smart relay (10 or 26 I/O)
- 2 Modbus or Ethernet communication modules
- 3 I/O extension module: discrete (6, 10 or 14 I/O) or analogue (4 I/O)

⚠ The order shown above must be observed when using a Modbus slave or Ethernet server communication module and a discrete or analogue I/O extension module. An I/O extension module cannot be fitted before the Modbus slave communication module.

Presentation

Zelio Logic smart relays are designed for use in small automated systems. They are used in both the industrial and commercial sectors.

■ For industry:

- automation of small finishing, production, assembly or packaging machines,
- decentralised automation of ancillary equipment of large and medium-sized machines (textile, plastics, materials processing sectors, etc.),
- automation systems for agricultural machinery (irrigation, pumping, greenhouses etc.)

■ For the commercial/building sectors:

- automation of barriers, roller shutters, access control,
- automation of lighting systems,
- automation of compressors and air conditioning systems.
- etc.

Their compact size and ease of setting-up make them a competitive alternative to solutions based on cabled logic or specific cards.

■ Programming

Simple programming, ensured by the universal nature of the languages, meets all the requirements of automation specialists and also the needs of the electrician.

Programming can be performed:

- independently, using the buttons on the Zelio Logic smart relay (ladder language),
- on a PC using “Zelio Soft 2” software.

When using a PC, programming can be performed either in LADDER language or in function block diagram (FBD) language, see page 10.

Backlighting of the LCD display (1) is obtained by activating one of the 6 programming buttons on the Zelio Logic smart relay or by programming with “Zelio Soft 2” software (example: flashing in the event of a malfunction).

The autonomous operating time of the clock, assured by a lithium battery, is 10 years.

Data backup (preset values and current values) is provided by an EEPROM Flash memory (10 years).

Compact smart relays

Compact smart relays meet requirements for simple automation systems.

The number of inputs/outputs can be:

- 12 or 20 I/O, supplied with ~ 24 V or ~ 12 V,
- 20 I/O, supplied with ~ 48 V,
- 10, 12 or 20 I/O, supplied with ~ 100...240 V or ~ 24 V.

Modular smart relays and extensions

The number of inputs/outputs for modular smart relays can be:

- 26 I/O, supplied with ~ 12 V,
- 10 or 26 I/O, supplied with ~ 24 V, ~ 100...240 V or ~ 24 V

To improve performance and flexibility, Zelio Logic modular smart relays can be fitted with communication modules and I/O extension modules to obtain a maximum of 40 I/O:

- Modbus or Ethernet communication modules, supplied with ~ 24 V via the Zelio Logic smart relay at the same voltage.
- analogue I/O extension modules with 4 I/O, supplied with ~ 24 V via the Zelio Logic smart relay at the same voltage,
- discrete I/O extension modules with 6, 10 or 14 I/O, supplied via the Zelio Logic smart relay at the same voltage.

(1) LCD: Liquid Crystal Display.



Connecting cable



Bluetooth interface



Memory cartridge



Modbus communication module



Ethernet communication module



Modem communication interface



Analogue PSTN Modem



GSM modem

Communication

Cabled and wireless programming tools

- These programming tools allow the Zelio Logic smart relay to be connected to a PC running “Zelio Soft 2” software:
 - Link by cables:
 - Cable SR2 CBL01 to 9-pin serial port
 - or
 - Cable SR2 USB01 to USB port
 - Wireless link:
 - Bluetooth interface SR2 BTC01

- Memory cartridge

The Zelio Logic smart relay can be fitted with a backup memory cartridge which enables the application program to be copied into another Zelio Logic smart relay. However, loading and updating of the firmware (software embedded in the product) is only possible with memory cartridge SR2 MEM02.

The memory cartridge also enables a backup copy of the program to be saved prior to replacing the product.

When used with a smart relay without display or buttons, the copy of the program contained in the cartridge is automatically transferred into the Zelio Logic smart relay on power-up.

Modbus slave and Ethernet server communication modules

Modbus and Ethernet communication modules allow connection to automation system equipment such as display units or programmable controllers (see page 22).

Modem communication interface

- The “Modem communication interface” products in the Zelio Logic range include:
- a Modem communication interface SR2 COM01 connected between a Zelio Logic smart relay and a Modem,
 - analogue (PSTN) (1) SR2 MOD01 or GSM (2) SR2 MOD02, Modems
 - “Zelio Logic Alarm” software SR2 SFT02.

They are designed for monitoring or remote control of machines or installations which operate without personnel.

The Modem communication interface, supplied with $\sim 12...24$ V, enables messages, telephone numbers and calling conditions to be stored, see page 32.

(1) Public Switched Telephone Network.
 (2) Global System Mobile.

Zelio Logic - Smart relays

Compact and modular smart relays

“Zelio Soft 2” programming software

“Zelio Soft 2” for PC - version 4.4 (1)

“Zelio Soft 2” software enables:

- programming in LADDER language or in function block diagram (FBD) language, see page 8,
- simulation, monitoring and supervision,
- uploading and downloading of programs,
- output of personalised files,
- automatic compiling of programs,
- on-line help.

Coherence tests and application languages

“Zelio Soft 2” software monitors applications by means of its coherence test function. An indicator turns red at the slightest input error. The problem can be located by simply clicking the mouse.

“Zelio Soft 2” software allows switching, at any time, to any of the 6 languages (English, French, German, Spanish, Italian, Portuguese) and editing of the application file in the selected language.

Inputting messages for display on Zelio Logic

“Zelio Soft 2” software allows Text function blocks to be configured, which can then be displayed on all Zelio Logic smart relays which have a display.

Program testing

2 test modes are provided:

- “Zelio Soft 2” **simulation** mode allows a program to be tested without a Zelio Logic smart relay, i.e.:
 - enable discrete inputs,
 - display the status of outputs,
 - vary the voltage of the analogue inputs,
 - enable the programming buttons,
 - simulate the application program in real time or in accelerated time,
 - dynamically display (in red) the various active elements of the program.
- “Zelio Soft 2” **monitoring** mode makes it possible to test the program executed by the smart relay, i.e.:
 - display the program “on-line”,
 - force inputs, outputs, control relays and current values of the function blocks,
 - adjust the time,
 - change from STOP mode to RUN mode and vice versa.

In simulation or monitoring mode, the monitoring window allows the status of the smart relay I/Os to be displayed within your application environment (diagram or image).

(1) These functions exist for all versions \geq v 4.1.

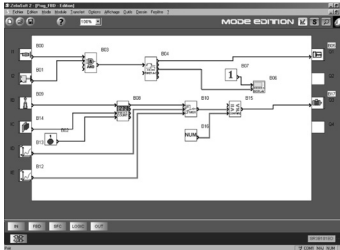

Programming in FBD language

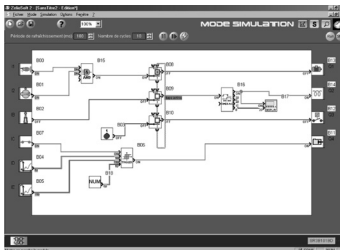

Simulation mode

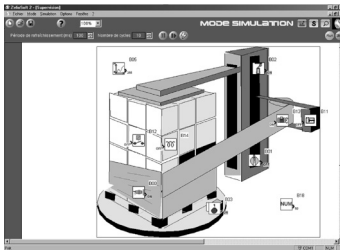

Monitoring window

User interfaces

“Zelio Soft 2” software (versions ≥ 4.1) improves, amongst other things, the ease of use of user interfaces for the following functions:

“Split wiring sheet” function (FBD language)

The wiring sheet can be split into 2. Splitting allows two separate parts of the wiring sheet to be displayed on the same screen.

This makes it possible to:

- Display the required function blocks in the top and bottom parts.
- Move the split bar as required.
- Connect the function blocks between the 2 parts of the wiring sheet.

The split wiring sheet is structured as follows:

- 1 View of top part
- 2 Top window vertical scroll bar
- 3 Top window horizontal scroll bar
- 4 Split bar
- 5 View of bottom part
- 6 Bottom window vertical scroll bar
- 7 Bottom window horizontal scroll bar

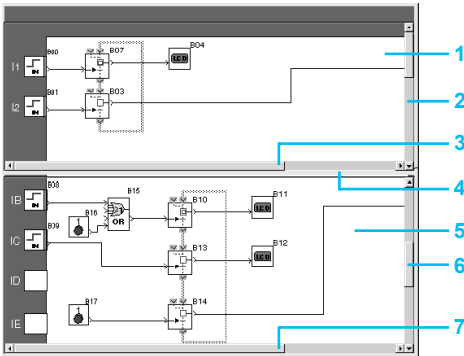

Structure of a split wiring sheet

“Replacement of a function block” (FBD language)

A function allows a block to be replaced without losing the input and output connections.

E.g.: Replacement of an “OR” block by a “NOR” block.

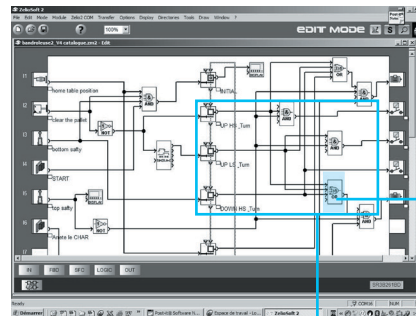

1 “OR” block to be replaced

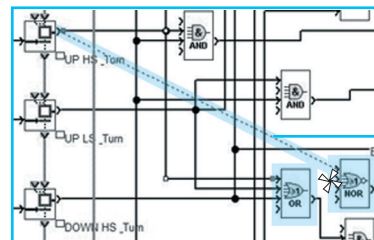

2 Move all links to the new “NOR” block

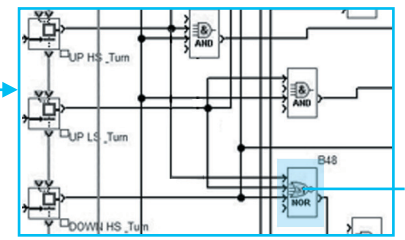

3 Delete the “OR” block and position the “NOR” block in its place

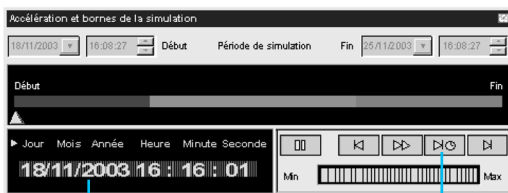

“Acceleration and simulation terminals” window

“Time Prog Simulation” function (LADDER and FBD languages)

LADDER or FBD program simulation mode allows the program to be debugged by simulating it on the software workshop host computer.

A function allows the time on the simulator clock to be modified by setting to 3 seconds before the start of the next event.

The “Next event” button 1 allows modification of the simulator clock 2.

LADDER language

Definition



Text function block



Timer



Up/down counter



Fast counter



Analogue comparator



Clock



Control relay



Counter comparator



LCD backlighting



Summer/Winter time switching



Output coil



Message

LADDER language enables a LADDER program to be written with elementary functions, elementary function blocks and derived function blocks, as well as with contacts, coils and variables.

The contacts, coils and variables can be annotated. Text can be placed freely within the graphic.

■ Control scheme input modes

“Zelio input” mode enables users who have directly programmed the Zelio Logic smart relay to find the same user interface, even when using the software for the first time.

“Free input” mode, which is more intuitive, is very user-friendly and incorporates many additional features.

With LADDER programming language, two alternative types of symbol can be used:

- LADDER symbols,
- electrical symbols.

“Free input” mode also allows the creation of mnemonics and notes associated with each line of the program.

Instant switching from one input mode to the other is possible at any time, by simply clicking the mouse.

Up to 120 control scheme lines can be programmed, with 5 contacts and 1 coil per program line

■ Functions:

- 16 Text function blocks,
- 16 time delay function blocks; parameters of 11 different types can be set for each of these (1/10th second to 9999 hours),
- 16 up/down counter function blocks from 0 to 32767,
- 1 fast counter (1 kHz),
- 16 analogue comparator function blocks,
- 8 clock function blocks, each with 4 channels,
- 28 control relays,
- 8 counter comparators,
- LCD screen with programmable backlighting,
- automatic Summer/Winter time switching,
- variety of functions: coil, latching (Set/Reset), impulse relay, contactor,
- 28 message blocks (with communication interface, see page 32).

Functions

Function	Electrical scheme	LADDER language	Notes
Contact			I corresponds to the real state of the contact connected to the input of the smart relay. i corresponds to the inverse state of the contact connected to the input of the smart relay.
Standard coil			The coil is energised when the contacts to which it is connected are closed.
Latch coil (Set)			The coil is energised (set) when the contacts to which it is connected are closed. It remains set even if the contacts are no longer closed.
Unlatch coil (Reset)			The coil is de-energised (reset) when the contacts to which it is connected are closed. It remains disabled even if the contacts are no longer closed.

Function block diagram language (FBD / Grafcet SFC / Logic functions) (1)



































Definition

FBD language allows graphical programming based on the use of predefined function blocks; it provides the use of:









- 34 pre-programmed functions for counting, time delay, timing, definition of switching threshold, (for example: temperature regulation), generation of impulses, time programming, multiplexing, display,
- 7 SFC functions,
- 6 logic functions.

Pre-programmed functions

Zelio Logic smart relays provide a high processing capacity, up to 200 function blocks, including 34 pre-programmed functions:

 <p>TIMER AC TIMER A/C</p> <p>Timer. Function A/C (ON-delay and OFF-delay)</p>	 <p>TIMER BH TIMER B/H</p> <p>Timer. Function BH. (adjustable pulsed signal)</p>	 <p>TIMER Li TIMER Li</p> <p>Pulse generator (ON-delay, OFF-delay)</p>	 <p>TIMER BW TIMER B/W</p> <p>Timer. Function BW (pulse on rising/falling edge)</p>	
 <p>TIMER AC TIMER A/C</p> <p>Timer. Function A/C with external preset adjustment (ON-delay and OFF-delay)</p>	 <p>TIMER BH TIMER B/H</p> <p>Timer. Function BH with external preset adjustment (adjustable pulsed signal)</p>	 <p>TIMER Li TIMER Li</p> <p>Pulse generator with external preset adjustment (ON-delay, OFF-delay)</p>	 <p>BISTABLE BISTABLE</p> <p>Impulse relay function</p>	 <p>SET-RESET SET RESET</p> <p>Bistable latching - Priority assigned either to SET or RESET function</p>
 <p>BOOLEAN BOOLEAN</p> <p>Allows logic equations to be created between connected inputs</p>	 <p>CAM CAM</p> <p>Cam programmer</p>	 <p>PRESET COUNT PRESET COUNT</p> <p>Up/down counter</p>	 <p>UP DOWN COUNT UP DOWN COUNT</p> <p>Up/down counter with external preset</p>	 <p>PRESET H-METER PRESET H-METER</p> <p>Hour counter (hour, minute preset)</p>
 <p>TIME PROG TIME PROG</p> <p>Time programmer, weekly and annual.</p>	 <p>GAIN GAIN</p> <p>Allows conversion of an analogue value by change of scale and offset.</p>	 <p>TRIGGER TRIGGER</p> <p>Defines an activation zone with hysteresis</p>	 <p>MUX MUX</p> <p>Multiplexing functions on 2 analogue values</p>	 <p>COMP IN ZONE MAX VAL MIN</p> <p>Zone comparison (Min. ≤ Value ≤ Max.)</p>
 <p>ADD/SUB +</p> <p>Add and/or subtract function</p>	 <p>MUL/DIV x</p> <p>Multiply and/or divide function</p>	 <p>TEXT TEXT</p> <p>Display of 4 pieces of data: digital, analogue, date, time, messages for Human-Machine interface.</p>	 <p>DISPLAY DISPLAY</p> <p>Display of digital and analogue data, date, time, messages for Human-Machine interface.</p>	 <p>COM COM</p> <p>Sending of messages with communication interface (see page 32)</p>
 <p>COMPARE COMPARE</p> <p>Comparison of 2 analogue values using the operands =, >, <, ≤, ≥.</p>	 <p>STATUS STATUS</p> <p>Access to smart relay status</p>	 <p>ARCHIVE ARCHIVE</p> <p>Storage of 2 values simultaneously</p>	 <p>SPEED COUNT SPEED COUNT</p> <p>Fast counting up to 1 kHz</p>	 <p>CAN CAN</p> <p>Analog/digital converter</p>
 <p>CNA CNA</p> <p>Digital/analogue converter</p>	 <p>SL In In</p> <p>Input of a word via serial link</p>	 <p>SL Out Out</p> <p>Output of a word via serial link</p>	 <p>SUNTRACK SUN SET RISE</p> <p>Follows the sun's position</p>	 <p>SUNRISE/SUNSET SUN SET RISE</p> <p>Outputs the sunrise and sunset times</p>

SFC functions(2) (GRAF CET)

 <p>RESET-INIT RESET-INIT</p> <p>Reinitialisable step</p>	 <p>INIT STEP INIT STEP</p> <p>Initial step</p>	 <p>STEP STEP</p> <p>SFC step</p>	 <p>DIV-OR 2 DIV-OR 2</p> <p>Divergence to OR</p>	 <p>CONV-OR 2 CONV-OR 2</p> <p>Convergence to OR</p>
 <p>DIV-AND 2 DIV-AND 2</p> <p>Divergence to AND</p>	 <p>CONV-AND 2 CONV-AND 2</p> <p>Convergence to AND</p>	 <p>SUN SET RISE</p>		

Logic functions

 <p>AND AND</p> <p>AND function</p>	 <p>OR OR</p> <p>OR function</p>	 <p>NAND NAND</p> <p>NOT AND function</p>	 <p>NOR NOR</p> <p>NOT OR function</p>	 <p>XOR XOR</p> <p>Exclusive OR function</p>	 <p>NOT NOT</p> <p>NOT function</p>
---	--	---	--	--	---

(1) Function Block Diagram
(2) Sequential Function Chart.

ⓘ New (version ≥ 4.4)

Function block diagram language (FBD / Grafset SFC / Logic functions) (continued)

Macro Function

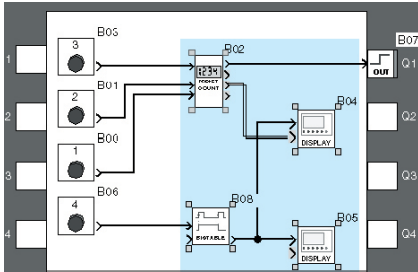

Creation of a Macro

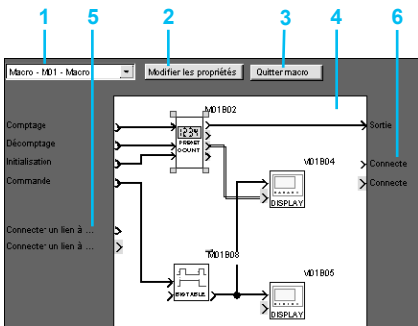

Inside of a Macro

- 1 Macro selection
- 2 Edit properties
- 3 Allows return to external view of a Macro
- 4 Internal function block within the Macro
- 5 Non connected inputs
- 6 Non connected outputs

A Macro is a grouping of function blocks. It is characterised by its number, its name, its links, its internal function blocks (255 max.) and by its I/O connections.

Seen from the outside, a Macro behaves like a function block with inputs and/or outputs that can be connected to links. Once created, a Macro can be manipulated like a function block.

■ Macro characteristics:

- The maximum number of Macros is 64.
- A password dedicated to Macros can be used to protect their content,
- A Macro can be edited / duplicated,
- A Macro's comments can be edited.

■ Macro properties:

A “Macro properties” dialogue box allows the properties of a Macro to be entered or edited.

The properties of a Macro are:

- Macro name (optional)
- The block Symbol, which may be:
 - an identifier,
 - an image.
- Name of inputs.
- Name of outputs.

Compact smart relays

With display - 10, 12 and 20 I/O

Without display - 10, 12 and 20 I/O

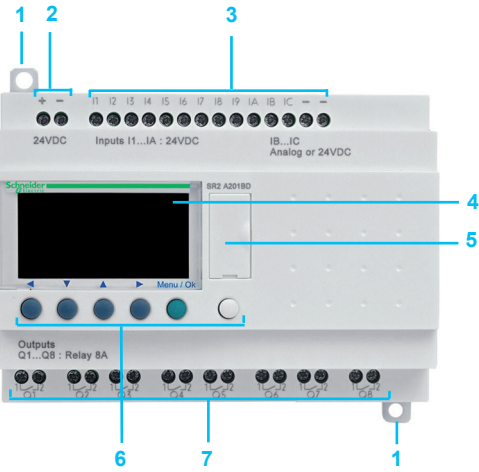

Zelio Logic compact smart relays have the following on their front panel:

- 1 Two retractable mounting feet
- 2 Two power supply terminals.
- 3 Terminals for connection of the inputs.
- 4 Backlit LCD display with 4 lines of 18 characters.
- 5 Slot for memory cartridge or connection to a PC or Modem communication interface.
- 6 6 buttons for programming and parameter entry.
- 7 Terminals for connection of the outputs

Modular smart relays

With display - 10 and 26 I/O

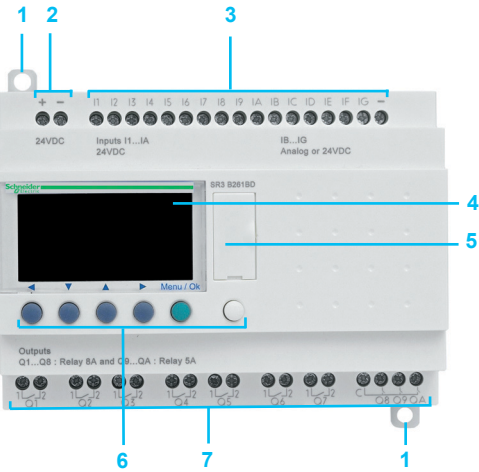

Zelio Logic modular smart relays have the following on their front panel:

- 1 Two retractable mounting feet
- 2 Two power supply terminals.
- 3 Terminals for connection of the inputs.
- 4 Backlit LCD display with 4 lines of 18 characters.
- 5 Slot for memory cartridge or connection to a PC or Modem communication interface.
- 6 6 buttons for programming and parameter entry.
- 7 Terminals for connection of the outputs

Discrete I/O extension modules

6 discrete I/O

10 and 14 discrete I/O

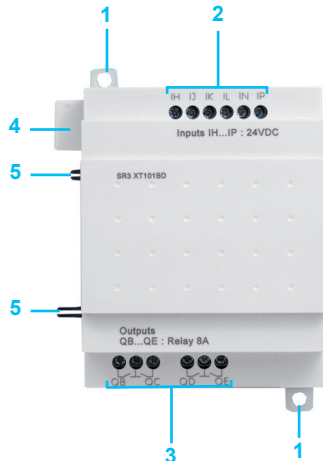
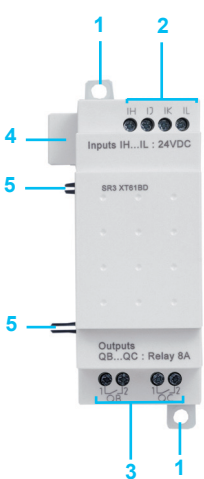

Discrete I/O extension modules have the following on their front panel:

- 1 Two retractable mounting feet
- 2 Terminals for connection of the inputs.
- 3 Terminals for connection of the outputs
- 4 A connector for connection to the Zelio Logic smart relay (powered via the Zelio Logic smart relay).
- 5 Locating pegs.

Zelio Logic - Smart relays

Compact smart relays



SR2 A201BD



SR2 SFT01



SR2 PACK●●●



Modem communication interface

Compact smart relays with display

Number of I/O	Discrete inputs	Including 0-10 V analogue inputs	Relay outputs	Transistor outputs	Clock	Reference	Weight kg
Supply ~ 24 V							
12	8	0	4	0	Yes	SR2 B121B	0.250
20	12	0	8	0	Yes	SR2 B201B	0.380
Supply ~ 48 V							
20	12	0	8	0	Non	SR2 A201E (1) (2)	0,380
Supply ~ 100...240 V							
10	6	0	4	0	No	SR2 A101FU (2)	0.250
12	8	0	4	0	Yes	SR2 B121FU	0.250
20	12	0	8	0	No	SR2 A201FU (2)	0.380
					Yes	SR2 B201FU	0.380
Supply ~ 12 V							
12	8	4	4	0	Yes	SR2 B121JD	0.250
20	12	6	8	0	Yes	SR2 B201JD	0.380
Supply ~ 24 V							
10	6	0	4	0	No	SR2 A101BD (2)	0.250
12	8	4	4	0	Yes	SR2 B121BD	0.250
			0	4	Yes	SR2 B122BD	0.220
20	12	2	8	0	No	SR2 A201BD (2)	0.380
		6	8	0	Yes	SR2 B201BD	0.380
			0	8	Yes	SR2 B202BD	0.280

“Zelio Soft 2” software

See page 20.

Accessories

See page 20.

Compact “discovery” packs

Number of I/O	Pack contents: - Compact smart relay with display - “Zelio Soft 2” programming software supplied on CD-Rom - Cable SR2 USB01 for connection to PC (3)	Reference	Weight kg
Description of compact smart relay with display			
Supply ~ 100...240 V			
12	SR2 B121FU	SR2 PACKFU	0.700
20	SR2 B201FU	SR2 PACK2FU	0.850
Supply ~ 24 V			
12	SR2 B121BD	SR2 PACKBD	0.700
20	SR2 B201BD	SR2 PACK2BD	0.700

Modem communication interface

Supply ~ 12...24 V			
Description	Application	Reference	Weight kg
Modem communication interface	For SR2 B	See page 32	0.200

(1) Can only be used with “Zelio Soft 2” software version ≥ V 3.1.

(2) Programming on Zelio Logic smart relay in LADDER language only.

(3) Replaces cable SR2 CBL01 which is available separately, as an accessory (see page 20).



SR2 E121BD



SR2 SFT01



SR2 USB01



Modem communication interface

Compact smart relays without display

Number of I/O	Discrete inputs	Including 0-10 V analogue inputs	Relay outputs	Transistor outputs	Clock	Reference	Weight kg
Supply ~ 24 V							
12	8	0	4	0	Yes	SR2 E121B	0.220
20	12	0	8	0	Yes	SR2 E201B	0.350
Supply ~ 100...240 V							
10	6	0	4	0	No	SR2 D101FU (1)	0.220
12	8	0	4	0	Yes	SR2 E121FU	0.220
20	12	0	8	0	No	SR2 D201FU (1)	0.350
					Yes	SR2 E201FU	0.350
Supply ~ 24 V							
10	6	0	4	0	No	SR2 D101BD (1)	0.220
12	8	4	4	0	Yes	SR2 E121BD	0.220
20	12	2	8	0	No	SR2 D201BD (1)	0.350
		6	8	0	Yes	SR2 E201BD	0.350

“Zelio Soft 2” software

See page 20.

Accessories

See page 20.

Modem communication interface

Supply ~ 12...24 V			
Description	Application	Reference	Weight kg
Modem communication interface	For SR2 E	See page 32	0.200

(1) Programming on Zelio Logic smart relay in LADDER language only.

Zelio Logic - Smart relays

Modular smart relays

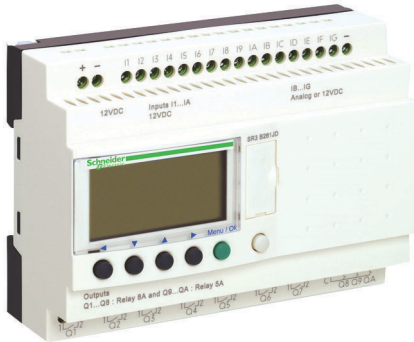

SR3 B261BD



SR2 SFT01



SR2 PACK●●●

Modular smart relays with display

Number of I/O	Discrete inputs	Including 0-10 V analogue inputs	Relay outputs	Transistor outputs	Clock	Reference	Weight kg
Supply ~ 24 V							
10	6	0	4	0	Yes	SR3 B101B	0.250
26	16	0	10 (1)	0	Yes	SR3 B261B	0.400
Supply ~ 100...240 V							
10	6	0	4	0	Yes	SR3 B101FU	0.250
26	16	0	10 (1)	0	Yes	SR3 B261FU	0.400
Supply ~ 12 V							
26	16	6	10 (1)	0	Yes	SR3 B261JD (2)	0.400
Supply ~ 24 V							
10	6	4	4	0	Yes	SR3 B101BD	0.250
			0	4	Yes	SR3 B102BD	0.220
26	16	6	10 (1)	0	Yes	SR3 B261BD	0.400
			0	10	Yes	SR3 B262BD	0.300

“Zelio Soft 2” software

See page 20.

Accessories

See page 20.

Modular “discovery” packs

Number of I/O	Pack contents: - Compact smart relay with display - “Zelio Soft 2” programming software supplied on CD-Rom - Cable SR2 USB01 for connection to PC (3) Description of compact smart relay with display	Reference	Weight kg
Supply ~ 100...240 V			
10	SR3 B101FU	SR3 PACKFU	0.700
26	SR3 B261FU	SR3 PACK2FU	0.850
Supply ~ 24 V			
10	SR3 B101BD	SR3 PACKBD	0.700
26	SR3 B261BD	SR3 PACK2BD	0.850

(1) Including 8 outputs at maximum current of 8 A and 2 outputs at maximum current of 5 A.

(2) Can only be used with “Zelio Soft 2” software version ≥ V 3.1.

(3) Replaces cable SR2 CBL01 which is available separately, as an accessory (see page 20).

Note: The Zelio Logic smart relay and its associated extensions must have an identical voltage.

Zelio Logic - Smart relays

Modular smart relays



Modbus communication module



Ethernet communication module



SR3 XT141JD



Modem communication interface

Modbus and Ethernet communication module (1)

Supply \sim 24 V (via smart relays SR3B...BD)

For use with	Network	Reference	Weight kg
Zelio Logic modular smart relays SR3 B●●1BD and SR3 B●●2BD	Modbus	See page 22	0.110
	Ethernet	See page 22	0.110

Analogue I/O extension module (2)

Supply \sim 24 V (via Zelio logic smart relay SR3 B...BD)

Number of I/O	Inputs	Including \sim		Including Pt100	Output \sim 0-10 V	Reference	Weight kg
		0-10 V	0-20 mA				
4	2 (3)	2 max	2 max	1 max	2	See page 30	0.110

Discrete I/O extension modules

Number of I/O	Discrete inputs	Relay outputs	Reference	Weight kg
Supply \sim 24 V (via Zelio Logic - Smart relays SR3 B●●●B)				
6	4	2	SR3 XT61B	0.125
10	6	4	SR3 XT101B	0.200
14	8	6 (4)	SR3 XT141B	0.220

Supply \sim 100-240 V (via Zelio logic smart relays SR3 B●●●FU)				
6	4	2	SR3 XT61FU	0.125
10	6	4	SR3 XT101FU	0.200
14	8	6 (4)	SR3 XT141FU	0.220

Supply \sim 12 V (via Zelio logic smart relay SR3 B261JD)				
6	4	2	SR3 XT61JD	0.125
10	6	4	SR3 XT101JD	0.200
14	8	6 (4)	SR3 XT141JD	0.220

Supply \sim 24 V (via Zelio logic smart relays SR3 B●●●BD)				
6	4	2	SR3 XT61BD	0.125
10	6	4	SR3 XT101BD	0.200
14	8	6 (4)	SR3 XT141BD	0.220

Modem communication interface (5)

Supply \sim 12...24 V

Description	Reference	Weight kg
Modem communication interface	See page 36	0.200

(1) See page 22.

(2) See page 30.

(3) See page 30.

(4) Including 4 outputs at maximum current of 8 A and 2 outputs at maximum current of 5 A.

(5) See page 32.

Note: The Zelio Logic smart relay and its associated extensions must have an identical voltage.

Zelio Logic - Smart relays

Compact and modular smart relays



SR2 SFT01



SR2 USB01



SR2 BTC01



SR2 MEM02



Regulated switch mode power supply



Converters for thermocouples

Programming

Description	Application	Reference	Weight kg
-------------	-------------	-----------	-----------

"Zelio Soft 2" software for PC

Programming software "Zelio Soft 2", multi-language supplied on CD-Rom (1)	With PC and 32 bits Operating Systems compatible with Windows XP, Vista and Windows 7 (2)	SR2 SFT01	0.200
--	---	------------------	-------

Connection accessories

Connecting cables Length: 3 m To be used with "Zelio Soft 2" software	Between the PC (SUB-D, 9-pin connector) and the Zelio Logic smart relay.	SR2 CBL01	0.150
--	--	------------------	-------

	Between the PC (USB connector) and the Zelio Logic smart relay. PC and 32 bits Operating Systems compatible with Windows XP, Vista and Windows 7 (2).	SR2 USB01	0.100
--	---	------------------	-------

Connecting cables Length: 2.5 m To be used with "Zelio Soft" software	Between the Magelis small panel (XBT N, XBT R or XBT RT) and the Zelio Logic smart relay. PC and 32 bits Operating Systems compatible with Windows XP, Vista and Windows 7 (2).	SR2 CBL08	0.100
--	---	------------------	-------

Bluetooth interface for Zelio Logic smart relays	Between the PC (wireless link) and the Zelio Logic smart relay. Range of 10 m (class 2)	SR2 BTC01 (3)	0.015
---	---	----------------------	-------

Bluetooth adapter for non-equipped PC Range of 10 m (class 2)	To be used in conjunction with SR2BTC01 when the PC is not equipped with Bluetooth technology. Connection to the USB port on the PC. PC and 32 bits Operating Systems compatible with Windows XP, Vista and Windows 7 (2)	VW3 A8115	0.290
---	---	------------------	-------

Memory cartridges (4)

EEPROM memory cartridges	For firmware (software embedded in the smart relay) version ≤ 2.4	SR2 MEM01	0.010
---------------------------------	---	------------------	-------

	For firmware (software embedded in the smart relay) version ≥ 3.0	SR2 MEM02	0.010
--	---	------------------	-------

Documentation available on line

User's manual for direct programming on the Zelio Logic smart relay (in french, english, german, spanish, italian or portuguese) : please consult our internet site www.schneider-electric.com

Regulated switch mode power supplies

Input voltage	Nominal output voltage	Reference	Weight kg
~ 100...240 V (50/60 Hz)	--- 5 V, --- 12 V or --- 24 V	See page 44	–

Converters

Description	Reference	Weight kg
-------------	-----------	-----------

Converters for J and K type thermocouples, for Pt100 probes and voltage/current	See page 40	–
--	-------------	---

(1) Supplied on CD-ROM comprising "Zelio Soft 2" software, an application library, a self-training manual, installation instructions and a user's manual.

(2) Scheduled availability: 4th quarter of 2010 for Windows Vista and Windows 7.

(3) Can only be used with "Zelio Soft 2" software version ≥ V 4.1.

(4) Program loading using memory cartridge SR2 MEM02 is incompatible with Modem communication interface SR2 COM01.

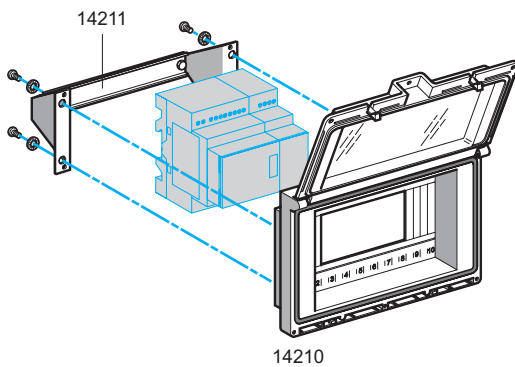

Mounting accessories

Description/application	Mounting capacity	Reference	Weight kg
Dust and damp-proof enclosure with split blanking plate arrangement, fitted with an IP 55 dust and damp-proof window with hinged flap, for mounting through a door	- 1 or 2 SR2 smart relays with 10 or 12 I/O or - 1 SR2 smart relay with 20 I/O or - 1 SR3 smart relay with 10 I/O + 1 I/O extension module (6, 10 or 14 I/O) or - 1 SR3 smart relay with 26 I/O + 1 I/O extension module (6 I/O).	14210	0.350
Fixing bracket and symmetrical mounting rail	For mounting enclosure	14210 14211	0.210



Smart relay

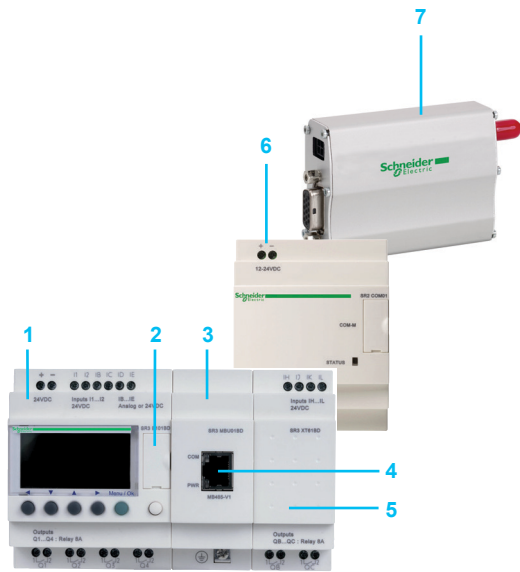

- 1 Modular smart relay (10 or 26 I/O).
- 2 RS 232 serial port, Zelio Logic type connector.
- 3 Modbus slave or Ethernet server communication module.
- 4 RJ45 connector for Modbus or Ethernet network connection.
- 5 I/O extension module: discrete (6,10 or 14 I/O) or analogue (4 I/O).
- 6 Modem communication interface.
- 7 GSM (or analogue PSTN) Modem.

Presentation

In order to communicate with an intelligent environment, Zelio Logic - Smart relays and their I/O extension and communication modules are equipped with various types of communication port.

- Compact and modular smart relays offer:
 - 1 RS 232 serial port for connection of the PC, the Modem communication interface or a memory cartridge slot.
- Zelio Logic modular smart relay I/O extension and communication modules offer:
 - 1 Modbus RS 485 port on communication module SR3 MBU01BD,
 - 1 Ethernet 10/100 base T port supporting the Modbus TCP protocol on communication module SR3 NET01BD.

These three ports allow Zelio Logic compact or modular smart relays to use 3 communication protocols:

- Programming,
- Modbus,
- Ethernet.

Communication ports on Zelio Logic - Smart relays and their I/O extension and communication modules:

Communication port	Serial port	Modbus port on communication module SR3 MBU01BD	Ethernet port on communication module SR3 NET01BD	Modem communication interface port
Physical layer	RS 232	RS 485	10/100 base T	RS 232
Connector	Specific to Zelio	RJ45	RJ45	Specific to Zelio
Compact smart relays	All types (connection and isolation via cable SR2 CBL01 or SR2 USB01)	–	–	All modules with clock SR2 B●●●●● SR2 E●●●●● (see page 36)
Modular smart relays	All types (connection and isolation via cable SR2 CBL01 or SR2 USB01)	All modules with $\overline{24}$ V supply SR3 B●●●BD	All modules with $\overline{24}$ V supply SR3 B●●●BD	All types (see page 36)

⚠ The order shown above must be observed when using a Modbus slave or Ethernet server communication module and a discrete or analogue I/O extension module. An I/O extension module cannot be fitted before the Modbus slave or Ethernet server communication module

Description

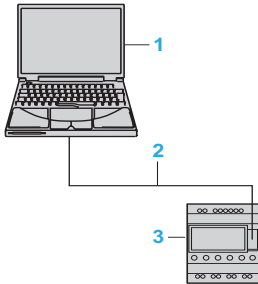

Link by cable

- 1 Programming PC.
- 2 RS 232 serial link cable (SR2 CBL01) or USB cable (SR2 USB01) (1).
- 3 Zelio Logic compact or modular smart relay.

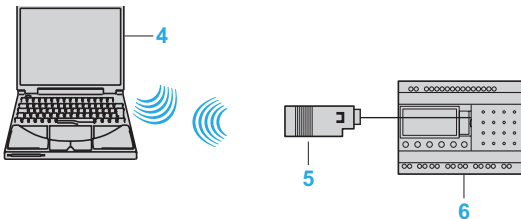

Wireless link

- 4 Programming PC with integrated Bluetooth technology (or Bluetooth adapter VW3 A8115 for PC not equipped with Bluetooth technology) (1).
- 5 Bluetooth interface (SR2 BTC01) for Zelio Logic smart relay (1).
- 6 Zelio Logic compact or modular smart relay.

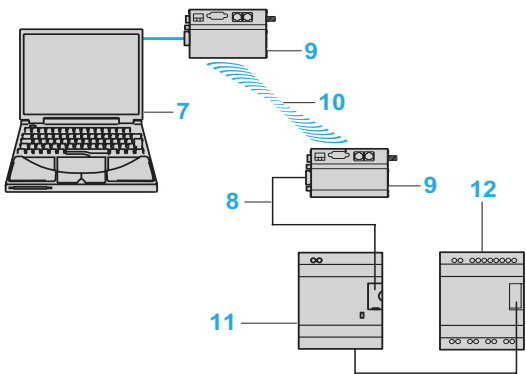

Link by Modem

- 7 Programming PC.
- 8 Modem interface connecting cable supplied with SR2 COM01(1).
- 9 Modem for transmitting/receiving data SR2 MOD01 or SR2 MOD02 (1).
- 10 Telephone or radio link.
- 11 Communication interface SR2 COM01.
- 12 Zelio Logic compact or modular smart relay.

(1) See page 20.



Modbus communication module

Presentation

The Modbus communication protocol is of the master/slave type.

Two exchange methods are possible:

■ Request/reply:

- The request from the master is addressed to a specific slave.
- The master waits for the reply to be returned by the slave polled.

■ Distribution:

- The master distributes a request to all the slave stations on the bus. These stations execute the instruction without sending a reply.

Zelio Logic modular smart relays are connected to the Modbus network via the Modbus slave communication module. This module is a slave that is not electrically isolated.

The Modbus slave communication module must be connected to an SR3 B●●●BD modular smart relay, with a \sim 24 V supply.

Configuration

The Modbus network slave communication module can be configured:

- independently, using the buttons on the smart relay (1).
- on a PC, using "Zelio Soft 2" software, see page 10.

When using a PC, programming can be performed either in LADDER language or in function block diagram (FBD) language, see page 12.

Description

Modbus slave communication module **SR3 MBU01BD** comprises:

- 1 Two retractable mounting feet.
- 2 A Modbus network connection (RJ45 shielded female connector).
- 3 A communication LED (COM).
- 4 A "Power on" LED (PWR).
- 5 A screw terminal block for the protective earth connection.
- 6 A spring for clip-on mounting on a 35 mm mounting rail.
- 7 Two locating pegs.
- 8 Two locating pegs for clip-on fixing.

(1) Programming from the front panel and buttons on the smart relay is only possible in LADDER language.

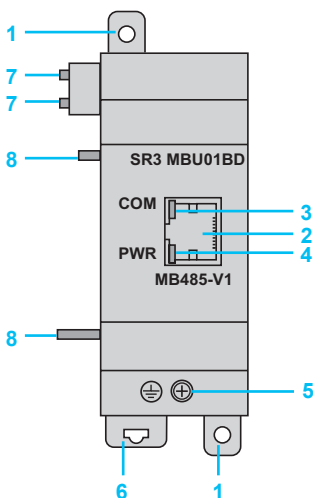

Connection examples

Example 1

- 1 Twido master.
- 2 Modbus network (cable TWD XCA RJP03)
- 3 Slave display unit XUBT N401.
- 4 Connecting cable XBT Z938.
- 5 Junction box TWD XCA T3RJ (polarisation and line end adapter activated).
- 5 bis Junction box TWD XCA T3RJ (no polarisation but line end adapter activated).
- 6 Modbus network (cables VW3 A8 306R●●).
- 7 T-junction VW3 A8 306TF●●.
- 8 ATV 31 variable speed controller.
- 9 Modbus communication module SR3 MBU01BD.
- 10 Modular smart relay SR3 B●●●BD.

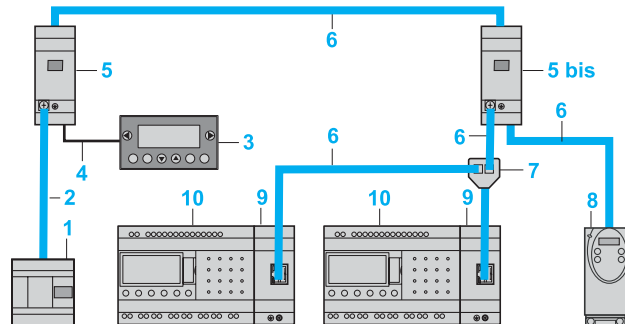

Total length of cables between Twido and ATV 31: ≤ 30 m

Example 2

- 1 Twido master.
- 2 Modbus network (cable TWD XCA RJP03)
- 3 Slave display unit XUBT N401.
- 4 Connecting cable XBT Z938.
- 5 Junction box TWD XCA ISO (polarisation and line end adapter activated).
- 5 bis Junction box TWD XCA ISO (no polarisation but line end adapter activated).
- 6 Modbus network (cables TSX CSA ●00).
- 7 Modbus network (cables VW3 A8 306R●●).
- 8 Supply cable 230 V.
- 9 Regulated power supply from the Phaseo Modular range.
- 10 T-junction 170XTS04100.
- 11 Modbus communication module SR3 MBU01BD.
- 12 Modular smart relay SR3 B●●●BD.

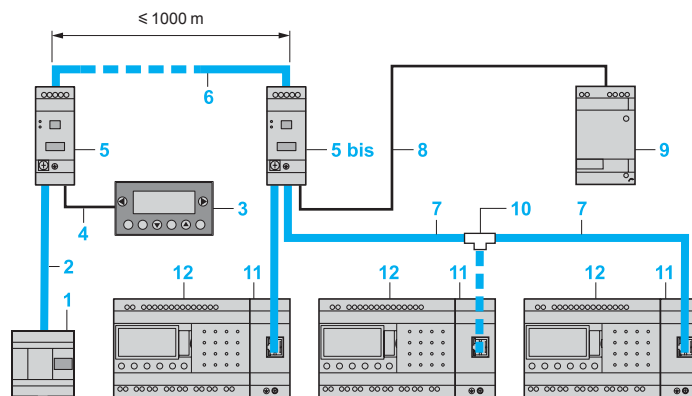

Function description

- The Modbus slave communication module is connected to a 2-wire or 4-wire Modbus network (1).
- The maximum length of the network between the two TWD XCAISO T-junctions is 1000 m (9600 bauds max., AWG 26).
- A maximum of 32 slaves can be connected to the Modbus network, or a maximum of 247 slaves with repeaters.
- Line end adapters must be fitted to both ends of the line (1 nF/10 V, 120 W /0.25 W in series).
- The line must be polarised (470 W /0.25 W resistors) (2).
- The connection cable and its RJ45 male connectors must be shielded.
- The ⚡ terminal on the module must be connected directly to the protective earth at one point on the bus.

(1) Please refer to installation instructions supplied with the product.

(2) The polarisation resistors must be managed by the master.

Zelio Logic - Smart relays

Communication

Modbus slave communication protocol

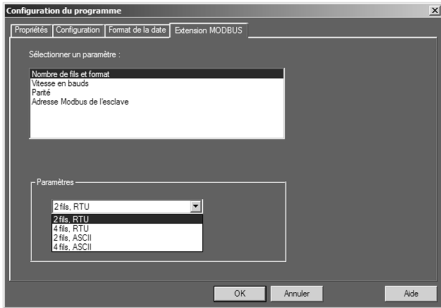

Software workshop parameter entry window

Parameter entry

Parameters can be entered either using “Zelio Soft 2” software, or directly using the buttons on the Zelio Logic smart relay (1).

When the “RUN” instruction is given, the Zelio Logic smart relay initialises the Modbus network slave communication module in a configuration previously defined in the basic program.

The Modbus slave communication module has 4 parameters:

- number of UART wires and format of the frames on the Modbus network,
- transmission speed,
- parity,
- network address of the Modbus module.

The default parameter settings are as follows: 2-wire, RTU, 19 200 bauds, even parity, address n° 1.

Parameter entry	Options
Number of wires	2 or 4
Frame format	RTU or ASCII
Transmission speed in bauds	1200, 2400, 4800, 9600, 19 200, 28 800, 38 400, 57 600
Parity	None, even, odd
Network address	1 to 247

Addressing of Modbus exchanges

LADDER programming

In LADDER mode, the 4 data words (16 bits) to be exchanged cannot be accessed by the application. Transfers with the master are implicit and are effected in a way that is totally transparent.

Modbus exchanges	Code	Number of words
Image of smart relay I/O	Read 03	4
Clock words	Read/Write 16, 06 or 03	4
Status words	Read 03	1

Function block diagram (FBD) programming

In FBD mode, the 4 input data words (16 bits) (J1XT1 to J4XT1) and the 4 output data words (O1XT1 to O4XT1) can be accessed by the application. Dedicated function blocks make it possible to:

- break down a 'complete' type input (16 bits) into 16 separate “bit” type outputs.
 - example: break down a J1XT1 to J4XT1 type input and copy these status values to discrete outputs.
- make up a 'complete' type output (16 bits) from 16 separate “bit” type inputs.
 - example: transfer the status value of the discrete inputs or the status of a function to an O1XT1 to O4XT1 type output.

Modbus exchanges	Code	Number of words
Input words	Read/Write 16, 06 or 03	4
Output words	Read 03	4
Clock words	Read/Write 16, 06 or 03	4
Status words	Read 03	1

(1) Programming from the front panel and buttons on the smart relay is only possible in LADDER language.

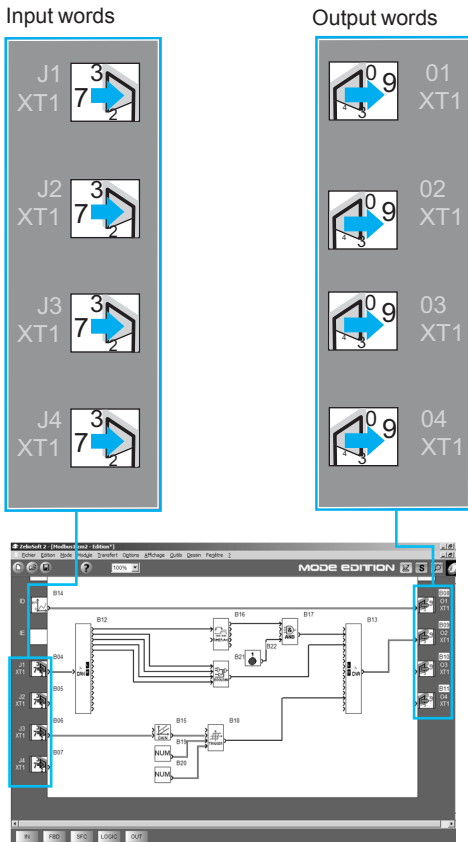

FBD program Editing window



Ethernet server communication module

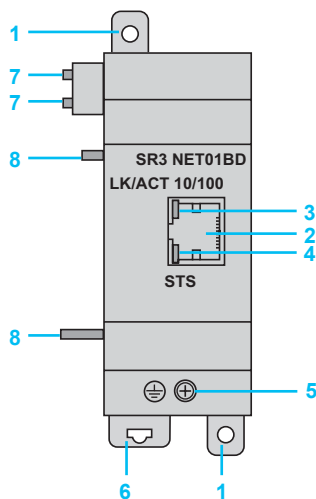

- 1 Twido client, 40 I/O compact base controller TWD LCAE 40DRF.
- 2 Ethernet network (cables 490 NTW 000●●).
- 3 ConneXium Switch 499 NES 2B1 00.
- 4 Zelio Logic modular smart relay SR3 B●●●BD.
- 5 Communication interface SR2 COM01.
- 6 Connecting cable SR2 CBL07 (supplied with the Modem communication interface).
- 7 GSM (or analogue PSTN) Modem.
- 8 Ethernet server network communication module SR3 NET01BD.
- 9 Analogue I/O extension module SR3 XT43BD.

Presentation

Zelio Logic modular smart relays are connected to the Ethernet network via the Ethernet server communication module.
Communication module SR3 NET01BD allows communication on the Ethernet network under the Modbus TCP protocol.
The Ethernet server communication module must be connected to an SR3 B●●●BD modular smart relay, with a \approx 24 V supply.

Configuration

The Ethernet server communication module can be configured from a PC with "Zelio Soft" software, see page 10.
On the PC, programming is effected in function block (FDB) language, see page 12.

Description

Ethernet server communication modules **SR3 NET01BD** comprise:

- 1 Two retractable mounting feet.
- 2 An Ethernet network connection (RJ45 shielded female connector).
- 3 A communication LED (LK/ACT 10/100).
- 4 A status LED (STS).
- 5 A screw terminal block for the protective earth connection.
- 6 A spring for clip-on mounting on a 35 mm mounting rail.
- 7 Two locating pegs.
- 8 Two locating pegs for clip-on fixing.

Connection example

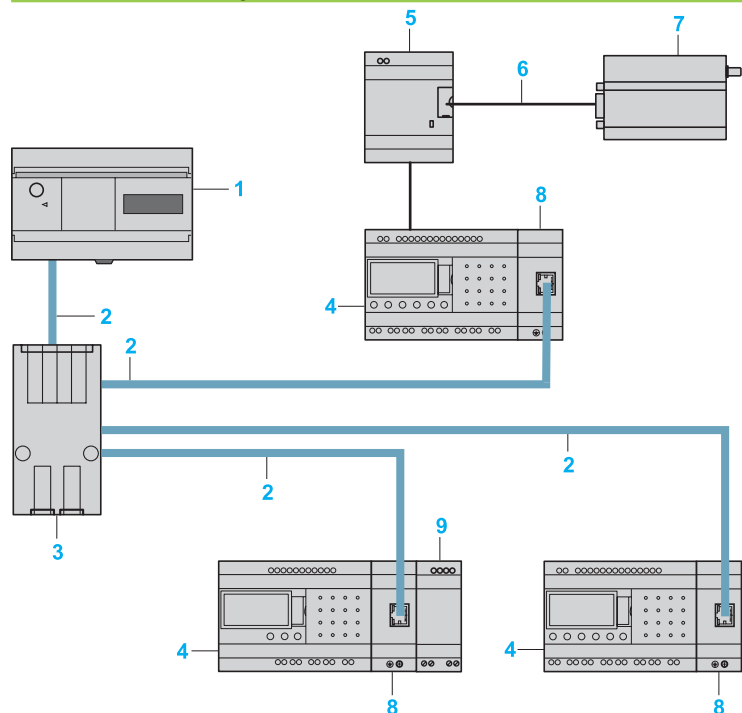

Function description

- The Ethernet server network communication module is connected to a local LAN type network.
- The maximum cable length between 2 devices is 100 m.
- The connection cable must be at least category 5, and its RJ45 male connectors must be shielded.
- The \oplus terminal must be connected directly to the protective earth.

Zelio Logic - Smart relays

Communication

Ethernet server network communication module

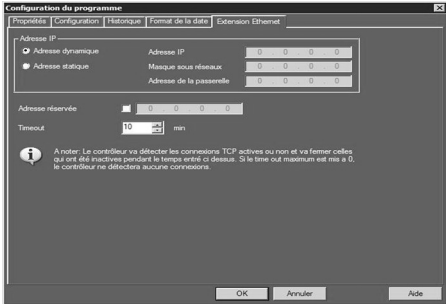

Ethernet communication module configuration window

Parameter entry

Parameter entry must be carried out using “Zelio Soft 2” software. When the “RUN” instruction is given, the Zelio Logic smart relay initialises the Ethernet server communication module in a configuration previously defined in the basic program.

The Ethernet server communication module has 6 parameters:

- type of addressing (dynamic or static).
- IP address,
- sub-network mask,
- gateway address,
- reserved address,
- time out.

Addressing of Ethernet exchanges

Function block diagram (FBD) programming

In FBD mode, the 4 input data words (16 bits) (J1XT1 to J4XT1) and the 4 output data words (O1XT1 to O4XT1) can be accessed by the application. Dedicated function blocks make it possible to:

- break down a ‘complete’ type input (16 bits) into 16 separate “bit” type outputs.
 - example: break down a J1XT1 to J4XT1 type input and copy these status values to discrete outputs.
- make up a ‘complete’ type output (16 bits) from 16 separate “bit” type inputs.
 - example: transfer the status value of the discrete inputs or the status of a function to an O1XT1 to O4XT1 type output.

Ethernet exchanges	Code	Number of words
Input words	Read/Write 16, 06 or 03	4
Output words	Read 03	4
Clock words 	Read/Write 16, 06 or 03	4
Status words	Read 03	1

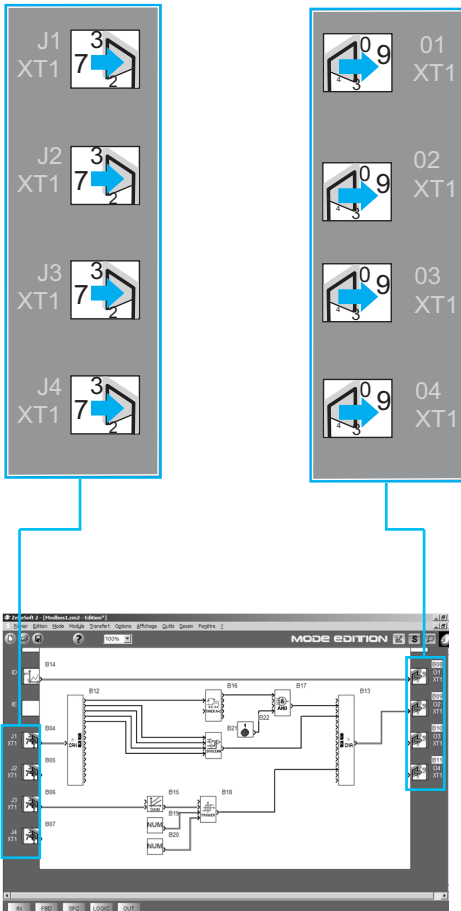

FBD program Editing window



SR3 MBU01BD



SR3 NET01BD



TWD XCA T3RJ



TWD XCA ISO



499 NES 251 00

Modbus slave and Ethernet server communication modules

For use with	Network	Reference	Weight kg
Zelio Logic modular smart relays SR3 B●●1BD and SR3 B●●2BD (1)	Modbus	SR3 MBU01BD	0.110
	Ethernet	SR3 NET01BD (2), (3)	0.110

Connection accessories

Accessory	Description	Network	Length m	Reference	Weight kg
T-junctions	<input type="checkbox"/> 2 x RJ45 connectors <input type="checkbox"/> 1 cable with integrated RJ45 connector	Modbus	0.3	VW3 A8 306TF03	0.190
			1	VW3 A8 306TF10	0.210
Junction boxes	<input type="checkbox"/> 2 x RJ45 female connectors <input type="checkbox"/> 1 x RJ45 male connector	Modbus	Without cable	170 XTS 04100	0.020
			<input type="checkbox"/> Screw terminal block for main cable <input type="checkbox"/> 2 x RJ45 connectors for tap link <input type="checkbox"/> Isolation of RS 485 serial link <input type="checkbox"/> Polarisation and line end adapter <input type="checkbox"/> Supply $\bar{\text{---}}$ 24 V <input type="checkbox"/> Mounting on 35 mm rail	Modbus	–
Line end adapter	For RJ45 connector R = 120W, C = 1 nf	Modbus	–	VW3 A8306RC	0.200
			<input type="checkbox"/> 3 x RJ45 connectors <input type="checkbox"/> Polarisation and line end adapter <input type="checkbox"/> Mounting on 35 mm rail	Modbus	–
RS 485 cables	2 x RJ45 connectors	Modbus	0.3	VW3 A8306R03	0.030
			1	VW3 A8306R10	0.050
			3	VW3 A8306R30	0.150
Main cables RS 485 shielded double twisted pair	Modbus serial link, supplied without connector	Modbus	100	TSX CSA 100	5.680
			200	TSX CSA 200	10.920
			500	TSX CSA 500	30.000
Straight shielded twisted pair cable	2 x RJ45 connectors	Ethernet	2	490 NTW 000 02 (4)	–
			5	490 NTW 000 05 (4)	–
			12	490 NTW 000 12 (4)	–
			40	490 NTW 000 40 (4)	–
			80	490 NTW 000 80 (4)	–
conneXium switch	–	Ethernet	–	499 NES 251 00	0.190

(1) Compatible with SR3 B●●2BD featuring hardware version "H1.0.01", available since June 2005.

(2) Can only be used in FBD language.

(3) Can only be used with "Zelio Soft 2" software version \geq V 4.1.

(4) Cable conforming to EIA/TIA-568 standard category 5 and IEC 1180/EN 50 173, class D. For UL and CSA 22.1 approved cables, add the letter U at the end of the reference.



Analogue I/O extension modules

Presentation

Modular smart relays and analogue I/O extension modules

To improve performance and flexibility, Zelio Logic modular smart relays can be fitted with analogue I/O extension modules with 10-bit resolution. The inputs accept 0-10 V, 0-20 mA and Pt 100 type signals.

Using a Zelio Logic modular smart relay with a \sim 24 V supply in conjunction with an analogue 4 I/O extension module makes it possible to obtain up to 30 I/O, including 8 analogue inputs and 2 analogue outputs.

The analogue I/O extension module must be connected to an SR3 ●●●BD modular smart relay with a \sim 24 V supply.

Combination of modular smart relays with communication and I/O extension modules



- 1 Modular smart relay (10 or 26 I/O)
- 2 Analogue I/O extension module (8 I/O)

Description

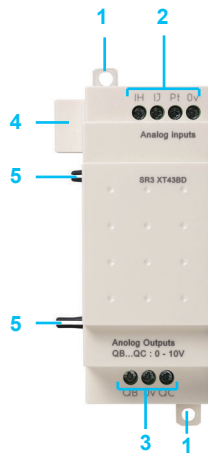

The analogue I/O extension module has the following on its front panel:

- 1 Two retractable mounting feet.
- 2 Terminals for connection of the inputs.
- 3 Terminals for connection of the outputs.
- 4 A connector for connection to the smart relay (powered via the smart relay).
- 5 Locating pegs.

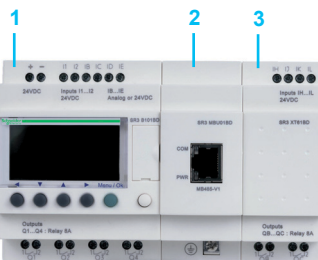

- 1 Modular smart relay (10 or 26 I/O)
- 2 Modbus or Ethernet communication modules
- 3 Analogue I/O extension module (4 I/O)

⚠ The order shown above must be observed when using a network communication module and an analogue I/O extension module.

An I/O extension module cannot be fitted before the network communication module.

Analogue I/O extension modules



SR3 XT43BD

Supply $\bar{\bar{}}$ 24 V (via smart relays SR3 B●●●BD)

Number of I/O	Number of inputs	Including 0-10 V	Including 0-20 mA	Including Pt100	0-10 V output	Reference	Weight kg
4	2	2 max	2 max	1 max	2	SR3 XT43BD (1),(2)	0.110

(1) Can only be used with "Zelio Soft 2" software version \geq V 3.1.

(2) Can only be used in FBD language.

Zelio Logic - Smart relays

Modem communication interface



Modem communication interface

Presentation

The communication products in the Zelio Logic range are primarily designed for monitoring or remote control of machines or installations which operate without personnel.

Examples:

- monitoring of lift pumps, livestock buildings (ventilation, feed level, etc.), refrigeration units, car-washes,
- alarm in the event of failure of industrial or domestic heating boilers,
- remote control of lighting: car parks, warehouses,
- remote control and monitoring of escalators in large stores, in the transport sector,
- refuse compactor full alert.

The communication range comprises:

- a communication interface connected between a smart relay and a Modem,
- GSM (1) or analogue (PSTN) (2) modems,
- "Zelio Logic Alarm" software.

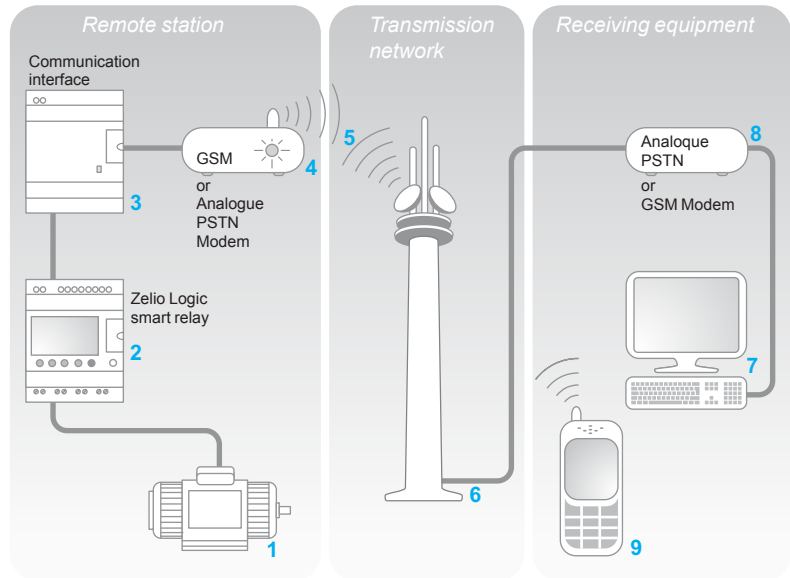

The system comprises:

- a *Remote station*, machine or installation to be monitored **1**: control is achieved using a Zelio Logic smart relay with clock from the SR● B●●●●● or SR2 E●●●●● **2** range, via its inputs and outputs. The smart relay is connected via a communication interface **3** to a GSM (1) type modem **4**, or, when a telephone line is available nearby, to an analogue PSTN modem (2),
- the GSM **5** or analogue PSTN **6** *Transmission network* provided by different telecommunication operators,
- a monitoring or control *Receiving device* which may be one of the following:
 - a PC **7** fitted with an analogue PSTN Modem **8** or a GSM modem,
 - or a GSM telephone **9**.

Note: the majority of Modems built into PCs can be used.

Various combinations are possible between the types of Modem used on the *Remote station* and the type of *Receiving device* (PC + Modems or GSM telephone). The type of architecture selected will therefore depend mainly on:

- whether or not an analogue telephone line is available,
- whether or not it is necessary to send SMS messages, see page 35.

(1) Global System Mobile.

(2) Public Switched Telephone Network.



GSM Modem



Analogue PSTN Modem

Presentation (continued)

Smart relay (*Remote station*)

- The smart relay, as on an independent machine or installation, is used for control (1). It contains the application program created using "Zelio Soft2" software. The smart relay may be selected from the various models in the Zelio Logic range:
 - for all supply voltages,
 - with 10, 12, 20 or 26 I/O (up to 40 I/O with discrete extension module),
 - with or without display,
 - with clock.

The firmware version of the smart relay must be V3 or above.

Modem communication interface (*Remote station*)

The Modem communication interface allows messages, telephone numbers and calling conditions to be stored.

When the calling conditions are met, the messages, as well as any values to be sent, are date-stamped and stored in the interface.

The Modem communication interface scales analogue values to the physical values (degrees, bar, Pascal, etc.) required by the user.

Modems

Either GSM or analogue PSTN type Modems can be used on both the *Remote Station* and PC type *Receiving devices* (when the PC is not fitted with an internal Modem).

GSM Modem

In order to exploit all the capabilities associated with Modem communication, the Modem(s) must be fitted with DATA type SIM cards. VOICE type SIM cards may be used but some functions will not be available. See table on page 35.

"Zelio Logic Alarm" alarm management software (*PC type Receiving device*)

This software makes it possible to:

- receive, classify and export alarm messages,
- read or remotely force the status of program elements (inputs, outputs, control relays, timing or counting values, etc.),
- send control instructions (RUN, STOP, setting the time of the smart relay, etc.),
- send specific instructions (modifying access rights, recipients, etc.).

(1) *Zelio Logic - Smart relays*, see page 8.

Description

The Zelio Logic SR2 COM01 communication interface comprises:

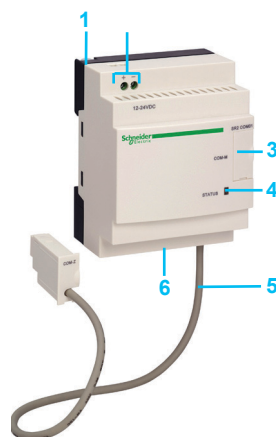

- 1 Retractable fixing lugs.
- 2 A 12...24 V supply terminal block.
- 3 A slot for connection to the Modem or the PC
- 4 An interface status LED indicator.
- 5 A connecting cable to the smart relay.
- 6 A spring for clip-on mounting on a 35 mm mounting rail.

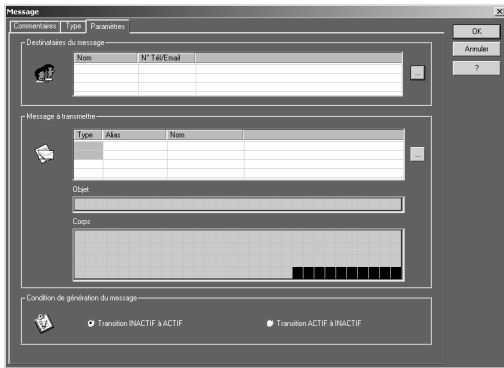

Message parameter entry window

Functions

Sending of alarms

This function makes it possible to send an alarm message to a *Receiving device*. When the calling condition is met, a message is sent to one or several telephone numbers or e-mail addresses.

Types of message:

- alarm message to a PC with Modem and "Zelio Logic Alarm" software,
- "SMS" message (1) to a GSM telephone,
- e-mail via SMS (1) (2).

One or all of the solutions can be selected simultaneously.

The *Remote station* to be monitored initiates the call.

The telephone line is only used while the alarm message is being transmitted.

Up to 28 messages can be used.

These messages consist of:

- a 160 character text, which may contain a discrete and/or analogue value (counting values, analogue input voltages that can be scaled, etc.),
- 1 to 10 recipient telephone numbers/e-mail addresses.

Receipt of instruction

This function allows the status or the value of a program element to be modified from the *Receiving device*.

The operator initiates the call using the *Receiving device* (PC or GSM telephone). It is then possible to force the status of the discrete and/or analogue value of each of the 28 messages.

Remote dialogue using "Zelio Soft 2"

This function enables use of the Transfer, Monitoring and Diagnostics modes available in "Zelio Soft 2" via the *Transmission network* instead of the physical link (cable SR2 USB01 or SR2 CBL01) between the product (*Remote station*) and the PC (*Receiving device*).

It is then possible to:



- transfer a program created on a PC station to the *Remote station*,
- transfer a program installed on the *Remote station* to the PC station,
- modify, from the PC, the receiving device telephone numbers/e-mail addresses, and the alarm sending conditions,
- update the firmware in the smart relay and in the Modem communication interface,
- display and modify discrete and analogue values,
- perform diagnostics on the smart relay and on the Modem communication interface.

(1) Requires the use of a GSM Modem on the *Remote station* side.

(2) Verify with the *Transmission network operator* that the e-mail by SMS service is available.

Functions available depending on the hardware architecture and/or type of SIM card

Function	Remote station device				
	Analogue PSTN Modem	GSM Modem			
		Type of SIM card		VOICE	
		DATA	DATA VOICE DATA N°	VOICE N°	VOICE
Send alarm/receive instruction with GSM telephone					
Send alarm/receive instruction with PC running "Zelio Logic Alarm" software (1)					
Transfer program					
Update firmware Monitoring (1)					
Send alarm to e-mail address					

 Functions available
 Functions not available

Note: Instructions cannot be transmitted by e-mail.

(1) When using a GSM Modem on the PC side, the SIM card must have a DATA number.

Installation set-up

Setting-up of the installation or the machine to be monitored involves 2 steps:

Connection for programming the smart relay and the interface

- 1 Interface cable marked COM-Z.
- 2 Cable SR2 USB01 or SR2 CBL01.

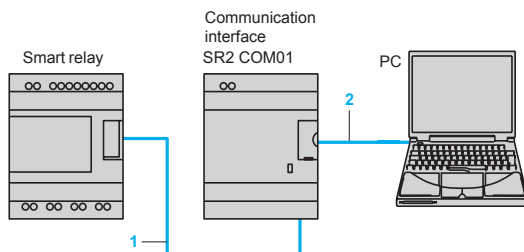

After having powered-up the smart relay and the interface, the application program can be transferred in order to simultaneously:

- load the automation system program into the smart relay,
- load the alarm conditions, messages and telephone numbers/e-mail addresses into the interface.

This operation can also be carried out remotely using "Transfer" mode, after having made the operating connections described below.

△ Program loading using memory cartridges SR2 MEM01 or SR2 MEM02 is incompatible with Modem communication interface SR2 COM01.

Operating connections

PSTN analogue modem

- 1 Interface cable marked COM-Z.
- 2 Cable SR2 CBL07 included with the interface.

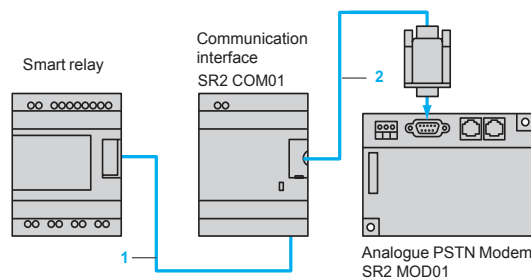

GSM Modem

- 1 Interface cable marked COM-Z.
- 2 Cable SR2 CBL07 included with the interface.
- 3 Antenna and cable included with the Modem.

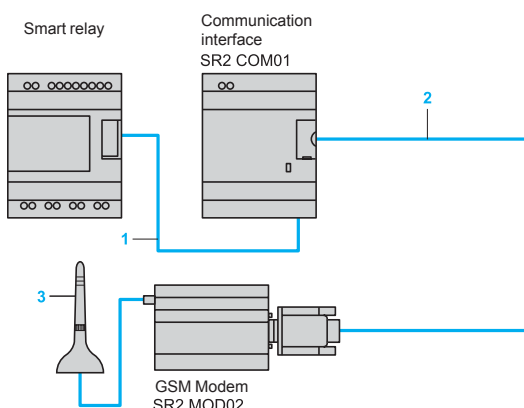



SR2 COM01



SR2 MOD01



SR2 MOD02

Modem communication interface

Description	For use with	Supply	Reference	Weight kg
Modem communication interface (including cable SR2 CBL07)	SR● B●●●●● SR2 E●●●●●	≡ 12...24 V	SR2 COM01 (1)	0.200

Modems

Description	Supply voltage	Reference	Weight kg
Analogue PSTN Modem Type SIXNET VT-MODEM-5-WW, including a telephone cable (length 2 m). Tested with SR2 COM01 (for additional information, please contact SIXNET company)	≡ 12...24 V	SR2 MOD01	0.265

GSM Modem Type quad band 900/1800 MHz, 850/1900 MHz including: ■ a supply cable (length 1.5 m), ■ an antenna with cable (length 2.5 m), ■ fixing on U-rail (assembled with the GSM Modem) ■ two lugs for plate mounting	≡ 12...24 V	SR2 MOD02 (2)	0.335
--	-------------	------------------	-------

(1) Can only be used with "Zelio Soft 2" software version ≥ 3.1 .

(2) Not recommended for Japan.

Zelio Logic - Smart relays

Modem communication interface



SR2 CBL07

Software				
Description	Application Compatibility	Medium	Reference	Weight kg
Zelio Logic Alarm	PC Windows 98, NT4, 2000 and XP	CD-ROM	SR2 SFT02	0.200

Connection accessories				
Description	Composition/ Application	Length	Reference	Weight
		m		kg
Connection cables	SUB-D9/SUB-D9 connectors Between Modem and PC	1.8	SR1 CBL03	0.110
	Specific Zelio/ SUB-D9 connector Between communication interface and modem	0.5	SR2 CBL07 (1)	0.050

(1) Spare part (cable included with communication interface SR2 COM01).

Analogue interfaces - Zelio Analog

Converters for thermocouples and Pt100 probes
Voltage/current converters

Product types

Converters for thermocouples



Input type	
Input signal	
Temperature range	
Voltage	
Current	

J (Fe-CuNi)			K (Ni-CrNi)	
0...150 °C	0...300 °C	0...600 °C	0... 600 °C	0...1200 °C
32...302 °F	32...572 °F	32...1112 °F	32...1112 °F	32...2192 °F
-				
-				

Output signal	Voltage/Current
----------------------	-----------------

Switchable: 0...10 V / 0...20 mA; 4...20 mA

Supply voltage	Rated
-----------------------	-------

~ 24V ± 20%, not isolated

Built-in protection	Outputs
	Supply

Reverse polarity, overvoltage and short-circuit
Output safety feature, if input not wired or wire broken
Reverse polarity

Signalling	
-------------------	--

Green LED (power on)

Conformity/Approvals	Conforming to standards Approvals
-----------------------------	--------------------------------------

IEC 60947-1, IEC 60584-1
UL, CSA, GL, CE

Type	
-------------	--

RMT J40BD	RMT J60BD	RMT J80BD	RMT K80 BD	RMT K90BD
------------------	------------------	------------------	-------------------	------------------

Pages	
--------------	--

42



Converters for Universal and Optimum Pt100 probes

Voltage/current converters



Pt100, 2, 3 and 4-wire					-				
-40...40 °C	-100...100 °C	0...100 °C	0...250 °C	0...500 °C	-				
-40...104 °F	-148...212 °F	32...212 °F	32...482 °F	32...932 °F	-				
-					0...10 V	0...10 V; ± 10 V	0...50 V; 0...300 V; 0...500 V ⎓ or ~ 50/60 Hz	-	
-					4...20 mA	0...20 mA; 4...20 mA	-	0...1.5 A; 0...5 A; 0...15 A ⎓ or ~ 50/60 Hz	
Switchable: 0... 10 V/0...20 mA, 4...20 mA for the Universal range RMP T●0BD 0...10 V or 4...20 mA for the Optimum range RMP T●3BD					0...10 V or 4...20 mA	Switchable: 0...10 V; ±10 V/ 0...20 mA; 4...20 mA	Switchable: 0...10 V/ 4...20 mA; 0...20 mA	0...10 V or 0...20 mA or 4...20 mA	
⎓ 24V ± 20%, not isolated					⎓ 24V ± 20%, isolated				
Reverse polarity, overvoltage and short-circuit Output safety feature, if input not wired or wire broken Reverse polarity									
Green LED (power on)									
IEC 60751, DIN 43 760 UL, CSA, GL, CE					IEC 60947-1				

- RMP T1●BD
- RMP T2●BD
- RMP T3●BD
- RMP T5●BD
- RMP T7●BD
- RMC N22BD
- RMC L55BD
- RMC V60BD
- RMC A61BD

42 and 43



More technical information on www.schneider-electric.com

Analogue interfaces - Zelio Analog

Converters for thermocouples and Pt100 probes

Voltage/current converters

The Zelio Analog range of converters is designed to convert signals emitted by sensors or electrical measurements into standard electrical signals which are compatible with automation platforms, controllers (thermal processes, speed, ...). They also allow the connection distance between a sensor and the measurement acquisition device to be increased: for example between a thermocouple and a programmable controller.

Conforming to IEC standards, UL and CSA certified, these converters are suitable for universal use.

Measurement signals for thermocouples and Pt100 probes

The voltages induced by thermocouples vary between 10 and 80 $\mu\text{V}/^\circ\text{C}$, Pt100 probes (100 ohms at 0 $^\circ\text{C}$) produce about 0.5 mV/ $^\circ\text{C}$, with measurement currents of 1 mA. Depending on the sensor, the signal to be measured ranges from a few μV (thermocouple) to 250 and 700 mV for a Pt100 probe.

It is therefore difficult to transmit these low level signals over long electric lines without encountering problems of interference, signal reduction or errors.

Connecting Zelio Analog converters close to the sensors resolves these problems :

- 4-20 mA current loops transmitted over a long distance are less sensitive to interference than low level voltage signals from sensors,
- signal reductions during transmission (resistance) of voltages do not occur,
- the cables used to connect the converters to process equipment (programmable controllers) are standard cables, which are more cost effective than extension cables or compensation cables suitable for low level signals for Pt100 probes or thermocouples.

Presentation

The Zelio Analog range

The Zelio Analog range has been developed both to take account of the most common applications and to ensure great simplicity of installation:

- pre-set input and output scales, requiring no adjustment
- outputs protected against reverse polarity, overvoltage and short-circuits
- $\pm 24\text{ V}$ power supply
- sealable protective cover
- rail mounting and screw fixing onto mounting plate
- LED indicator on the front panel
- input and output selector switches on the front panel
- output with fallback value if no input signal is present (due to failure of a sensor, for example).

The Zelio Analog converter range is divided into four families:

- Converters for J and K type thermocouples: **RMT J/K**
- Universal converters for Pt100 probes: **RMP T●0**
- Optimum converters for Pt100 probes: **RMP T●3**
- Universal voltage/current converters: **RMC**.

Converters for J and K type thermocouples

Thermocouples, which consist of two metals with different thermo-electric characteristics, produce a voltage that varies according to temperature. This voltage is transmitted to the Zelio Analog converter which converts it to a standard signal.

Converters for thermocouples have cold junction compensation to allow detection of measurement errors induced by the connection to the device itself.

Converters for J and K type thermocouples have:

- for inputs, a pre-set temperature range, depending on the model:
 - Type J: 0...150 $^\circ\text{C}$, 0...300 $^\circ\text{C}$, 0...600 $^\circ\text{C}$
 - Type K: 0...600 $^\circ\text{C}$, 0...1200 $^\circ\text{C}$.
- for outputs, a switchable signal:
 - 0...10 V, 0... 20 mA, 4... 20 mA.



RMT J40BD



RMT K90BD

Analogue interfaces - Zelio Analog

Converters for thermocouples and Pt100 probes

Voltage/current converter



RMP T70BD

Universal converters for Pt100 probes

Pt100 probes with platinum resistor are electrical conductors whose resistance varies according to the temperature.

This ohmic resistance is transmitted to the Zelio Analog converter which converts it to a standard signal.

Universal converters for Pt100 probes have :

■ for inputs, a pre-set temperature range, depending on the model:

- 100...100 °C,
- 40...40 °C,
- 0...100 °C,
- 0...250 °C,
- 0...500 °C.

■ for outputs, a switchable signal:

- 0... 10 V, 0... 20 mA, 4... 20 mA.

The products in the family Universal converters for Pt100 probes allow wiring of Pt100 probes in 2, 3 and 4-wire mode.

Optimum converters for Pt100 probes

Derived from the above family, these converters have:

■ for inputs, a pre-set temperature range identical to that of universal converters for Pt100 probes.

■ for outputs: 0...10V signal dedicated to Zelio Logic analogue inputs.

They allow Pt100 probes to be wired in 2, 3 and 4-wire mode.



RMC A61BD

Universal voltage/current converters

This family of converters allows the adaptation of electrical values (voltage/current). Four products are available:

■ a cost effective converter which will convert a 0...10 V signal to a 4...20mA signal or vice versa.

■ a Universal voltage/current converter allowing the most common signals. They have:

- for inputs, a voltage/current range:
 - 0... 10 V, ± 10 V, 0...20 mA, 4...20 mA.
- for outputs, a switchable voltage/current range:
 - 0...10 V, ± 10 V, 0...20 mA, 4...20 mA.

■ two Universal voltage/current converters which allow conversion of electrical power signals, both a.c. and d.c.

They have the following, depending on the model:

- for voltage inputs**, a range of 0 to 500 V (~ or ---)
- for outputs, a switchable voltage/current range:
 - 0... 10 V, 0...20 mA, 4...20 mA.
- for current inputs**, a range of 0 to 15 A (~ or ---)
- for outputs, a voltage/current range:
 - 0...10 V, 0...20 mA, 4...20 mA.

Description

Zelio Analog converters have the following on their front panel, depending on the model:

- 1 Two terminals for --- 24 V supply connection
- 2 A 'Power ON' LED
- 3 Three input selector switches (depending on model)
- 4 An output selector switch (depending on model)
- 5 A sealable protective cover
- 6 A screw terminal block for inputs
- 7 A screw terminal block for outputs.

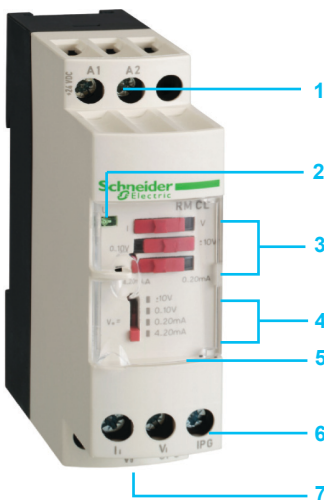

RMC L55BD

Analogue interfaces - Zelio Analog

Converters for thermocouples and Pt100 probes

Voltage/current converters



RMT J40BD



RMT K90BD



RMP T70BD



RMP T13BD

Converters for J and K type thermocouples

Supply voltage $\approx 24\text{ V} \pm 20\%$, non isolated

Type	Temperature range		Switchable output signal	Reference	Weight kg
	°C	°F			
Type J	0...150	32...302	0...10 V, 0...20 mA, 4...20 mA	RMT J40BD	0.120
	0...300	32...572	0...10 V, 0...20 mA, 4...20 mA	RMT J60BD	0.120
	0...600	32...1112	0...10 V, 0...20 mA, 4...20 mA	RMT J80BD	0.120
Type K	0...600	32...1112	0...10 V, 0...20 mA, 4...20 mA	RMT K80BD	0.120
	0...1200	32...2192	0...10 V, 0...20 mA, 4...20 mA	RMT K90BD	0.120

Universal converters for Pt100 probes

Supply voltage $\approx 24\text{ V} \pm 20\%$, non isolated

Type	Temperature range		Switchable output signal	Reference	Weight kg
	°C	°F			
Pt100 2-wire, 3-wire and 4-wire	-40...40	-40...104	0...10 V, 0...20 mA, 4...20 mA	RMP T10BD	0.120
	-100...100	-148...212	0...10 V, 0...20 mA, 4...20 mA	RMP T20BD	0.120
	0...100	32...212	0...10 V, 0...20 mA, 4...20 mA	RMP T30BD	0.120
	0...250	32...482	0...10 V, 0...20 mA, 4...20 mA	RMP T50BD	0.120
	0...500	32...932	0...10 V, 0...20 mA, 4...20 mA	RMP T70BD	0.120

Optimum converters for Pt100 probes (1)

Supply voltage $\approx 24\text{ V} \pm 20\%$, non isolated

Type	Temperature range		Output signal	Reference	Weight kg
	°C	°F			
Pt100 2-wire, 3-wire and 4-wire	-40...40	-40...104	0...10 V or 4...20 mA	RMP T13BD	0.120
	-100...100	-148...212	0...10 V or 4...20 mA	RMP T23BD	0.120
	0...100	32...212	0...10 V or 4...20 mA	RMP T33BD	0.120
	0...250	32...482	0...10 V or 4...20 mA	RMP T53BD	0.120
	0...500	32...932	0...10 V or 4...20 mA	RMP T73BD	0.120

(1) Converters dedicated to Zelio Logic smart relays.

Analogue interfaces - Zelio Analog

Converters for thermocouples and Pt100 probes
Voltage/current converters



RMC N22BD



RMC L55BD



RMC A61BD

Universal voltage/current converters

Supply voltage $\approx 24\text{ V} \pm 20\%$, non isolated

Input signal	Output signal	Reference	Weight kg
0...10 V or 4...20 mA	0...10 V or 4...20 mA	RMC N22BD	0.120

Supply voltage $\approx 24\text{ V} \pm 20\%$, isolated

Input signal	Output signal	Reference	Weight kg
0...10 V, $\pm 10\text{ V}$, 0...20 mA, 4...20 mA	Switchable: 0...10 V, $\pm 10\text{ V}$, 0...20 mA, 4...20 mA	RMC L55BD	0.120

0...50 V, 0...300 V, 0...500 V \approx or $\sim 50/60\text{ Hz}$	Switchable: 0...10 V, 0...20 mA, 4...20 mA	RMC V60BD	0.150
---	--	-----------	-------

0...1.5 A, 0...5 A, 0...15 A \approx or $\sim 50/60\text{ Hz}$	0...10 V or 0...20 mA or 4...20 mA	RMC A61BD	0.150
---	---------------------------------------	-----------	-------

Connection accessories

Description	Type	Sold in lots of	Unit reference	Weight kg
Terminal blocks for connection of protective earth conductor	Screw	100	AB1 TP435U	0.025
	Spring	100	AB1 RRNTP435U2	0.010

Phaseo power supplies and transformers

Regulated switch mode power supplies
ABL 8MEM, ABL 7RM
7 to 60 W - Rail mounting

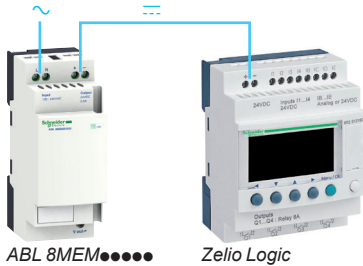

Regulated switch mode power supplies ABL 8MEM, ABL 7RM

The ABL 8MEM, ABL 7RM power supply offer is designed to provide the DC voltage necessary for the control circuits of automation system equipment consuming 7 to 60 W in 5, 12 and 24 V DC .

Comprising six products, this range meets the needs encountered in industrial, commercial and residential applications. These compact electronic switch mode power supplies provide a quality of output current that is suitable for the loads supplied and compatible with the **Zelio Logic** range and the smallest **Modicon M340, Premium** and **Quantum** configurations.

Clear guidelines are given on selecting the upstream protection devices which are often used with them, and thus a comprehensive solution is provided that can be used in total safety.

ABL 8MEM/7RM power supplies can be connected in phase-to-neutral (N-L1) or in phase-to-phase (1) (L1-L2). They deliver a voltage that is precise to 3%, whatever the load and whatever the type of line supply, within a range of 85 to 264 V \sim .

Conforming to IEC standards and UL, CSA and TUV certified, they are suitable for universal use. The inclusion of overload and short-circuit protection makes downstream protection unnecessary if discrimination is not required.

Due to their low power, ABL 8MEM/7RM power supplies consume very little harmonic current and thus are not subject to the requirements of standard IEC/EN 61000-3-2 concerning harmonic pollution.

All ABL 8MEM/7RM power supplies have protection devices to ensure optimum performance of the automation system with an automatic reset mode on elimination of the fault.

All products are equipped with an output voltage adjustment potentiometer to compensate for any line voltage drops in installations with long cable runs.

These power supplies also have a cable run inside the case so that the outputs can be connected at the top or bottom of the product as required.

These power supplies are designed for direct mounting on 35 mm U rails, or on a mounting plate using their retractable fixing lugs.

There are six references available in the Phaseo ABL 8MEM/7RM range:

■ ABL8MEM24003	7 W	0.3 A	24 V DC
■ ABL8MEM24006	15 W	0.6 A	24 V DC
■ ABL8MEM24012	30 W	1.2 A	24 V DC
■ ABL7RM24025	60 W	2.5 A	24 V DC
■ ABL8MEM05040	20 W	4 A	5 V DC
■ ABL8MEM12020	25 W	2 A	12 V DC

(1) 240 V \sim nominal.

Description

ABL 8MEM



ABL7RM24025

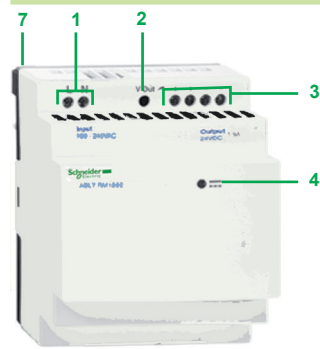

- 1 2.5 mm² screw terminal for connection of the incoming AC voltage
- 2 Output voltage adjustment potentiometer
- 3 2.5 mm² screw terminal for connection of the output voltage
- 4 LED indicating presence of the DC output voltage
- 5 Duct for throughwiring of the output voltage conductors at the bottom (except for model ABL 7RM24025)
- 6 Clip-on marker tag (except for model ABL 7RM24025)
- 7 Retractable fixing lugs for panel mounting

Phaseo power supplies and transformers

Regulated switch mode power supplies
ABL 8MEM, ABL 7RM
7 to 60 W - Rail mounting

Selection of protection on the power supply primaries

Type of line supply	100 to 240 V ~ single-phase		
Type of protection	Thermal-magnetic circuit breaker		gG fuse
	GB2 (IEC) (1)	C60N (IEC) C60N (UL/CSA)	
ABL 8MEM05040	GB2 ●●07 (2)	24581 24517	2 A
ABL 8MEM12020			
ABL 8MEM24003			
ABL 8MEM24006			
ABL 8MEM24012			
ABL 7RM24025	GB2 ●●08 (2)	24582 24518	3 A

(1) UL pending

(2) Complete the reference by replacing ●● with:

CB: for single-pole circuit-breaker with magnetic trip threshold 12 to 16 In

CD: for single-pole + neutral circuit-breaker with magnetic trip threshold 12 to 16 In

DB: for 2-pole circuit-breaker with magnetic trip threshold 12 to 16 In

CS: for single-pole circuit-breaker with magnetic trip threshold 5 to 7 In

References



ABL 8MEM05040/12020/24012



ABL 8MEM24003/24006



ABL 7RM24025

Input voltage	Secondary		Reset	Conformity to standard IEC/EN 61000-3-2 (1)	Reference	Weight kg
	Output voltage	Nominal power Nominal current				
Single-phase (N-L1) or 2-phase (L1-L2) connection						
100...240 V -15%, + 10% 50/60 Hz	5 V ~	20 W 4 A	Automatic	Not applicable	ABL 8MEM05040	0.195
	12 V ~	25 W 2 A	Automatic	Not applicable	ABL 8MEM12020	0.195
	24 V ~	7 W 0.3 A	Automatic	Not applicable	ABL 8MEM24003	0.100
		15 W 0.6 A	Automatic	Not applicable	ABL 8MEM24006	0.100
		30 W 1.2 A	Automatic	Not applicable	ABL 8MEM24012	0.195
		60 W 2.5 A	Automatic	Not applicable	ABL 7RM24025	0.255
Description	Use	Order in multiples of	Unit reference	Weight kg		
Clip-on marker tags	Replacement parts for ABL 8MEM power supplies	100	LAD 90	0.030		

(1) Due to their power < 75 W, ABL 8MEM/7RM power supplies are not subject to the requirements of standard IEC/EN 61000-3-2.

Schneider Electric Industries SAS

www.schneider-electric.com

Head Office
35, rue Joseph Monier
F-92500 Rueil-Malmaison
France

The information provided in this documentation contains general descriptions and/or technical characteristics of the performance of the products contained herein. This documentation is not intended as a substitute for and is not to be used for determining suitability or reliability of these products for specific user applications. It is the duty of any such user or integrator to perform the appropriate and complete risk analysis, evaluation and testing of the products with respect to the relevant specific application or use thereof. Neither Schneider Electric nor any of its affiliates or subsidiaries shall be responsible or liable for misuse of the information contained herein.

Design: Schneider Electric
Photos: Schneider Electric
Printed by: