

INSTALLATION INSTRUCTIONS

1. Overview

Connections: The SD1+ is connected between the leak detection control panel (alarm unit with volt free contacts) and the telephone line. It behaves like another extension to the telephone and does not affect its normal operation or that of any other extension fitted. A 12Vdc (11.5 to 14Vdc, 100mA) power supply is required to operate the unit. A 220Vac/12Vdc power unit is provided AT-SD1+PSU.

The SD1+ accepts three trigger inputs which in our example are; A - Leak Detected, B - Cable Break, C - Service Required and D - Auxiliary. These inputs correspond to the messages (A, B, C or D) that the SD1+ sends out and should be recorded as such. The SD1+ can also accept a direct connection from suitable auxiliary devices, such as optical sensor, float switch or any device using volt free contacts.

Telephone Numbers: The SD1+ will dial up to four different telephone numbers and play its message. The numbers may be up to 24 digits long and are simply programmed using the text display and keypad on the unit. The SD1+ also supports pager numbers. Note: The SD1+ must NOT be used to call the Police via the Emergency Services phone numbers.

Messages: The SD1+ has a built-in microphone and speaker so that messages can be recorded and replayed directly from the unit. When the outgoing call is answered the SD1+ plays a common phrase (0) and one of the three alarm messages (phrases A, B or C). Phrase 0 normally states the name and address of the site and phrases A, B and C relate to the inputs from the control panel (Leak, Cable Break, Service Required in our example). A total of 40 seconds is available for recording messages.

Acknowledgement: On receiving a call from the SD1+ the person answering the call can acknowledge it by pressing number [8] on their telephone. If the message is not acknowledged then it is repeated four times after which the SD1+ abandons the call. The SD1+ has several acknowledgement options which allows the unit to stop dialling after the first call has been acknowledged or when two or three have been acknowledged.

Abort: The SD1+ has several abort options, which include applying a signal to the abort input, restoring the trigger input or by entering the operators passcode. When the unit is aborted it immediately shuts down and returns to its normal standby mode.

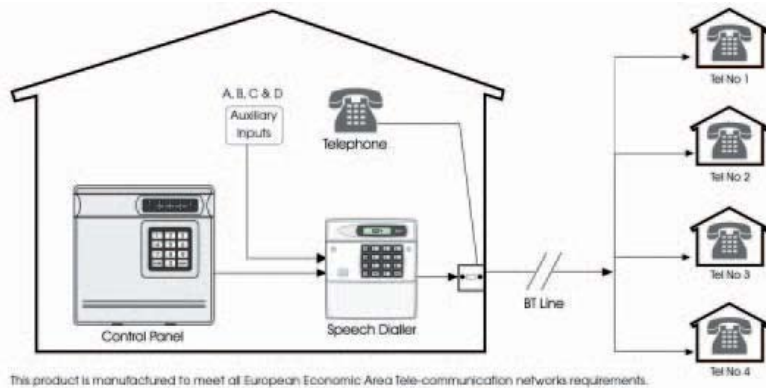
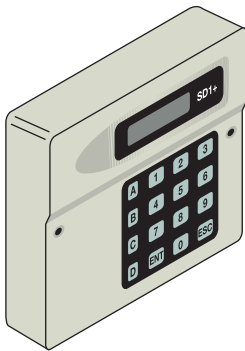

2. Installation Requirements

The SD1+ has been designed to be connected to a TraceTek or AquiTron™ alarm control.

The unit is supplied with a 2 metre telephone lead which will plug directly into any standard BT socket and it is therefore recommended that the unit is sited as near to a BT telephone socket as possible. If this it not possible an approved BT extension lead may be required or the unit can be hard wired to the BT socket (see section 8).

3. Mounting Instructions

1. Separate the cover from the base by using a screwdriver to push two of the retaining clips (top or bottom) inwards from the base indents. Remove cover assembly and store in a safe place.
2. Hold the base in position (keyhole to the top) and mark the three securing holes. Remove the base then drill and plug the holes.
3. Pass all cables into the base through the cable entries and then secure the base to wall.

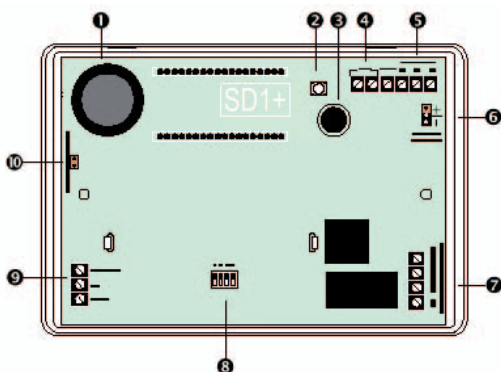

4. PCB Layout

1. Loudspeaker
2. Not active
3. Microphone
4. Tamper connections (SELV)
5. Trigger Inputs (SELV)
6. Trigger Polarity
7. Telephone Connections (TNV)
8. Country Setting (Not fitted on UK product)
9. 12V Supply and Programmable O/P (SELV)
10. Factory Restart Pins

5. SD1+ Connections

Before any connections are made to the SD1+ it is recommended that power to the Leak Detection control panel is removed. Connections are provided as follows:

- TRIG A:** When triggered, the unit starts the dialling sequence and sends message A.
- TRIG B:** When triggered, the unit starts the dialling sequence and sends message B.
- TRIG C:** When triggered, the unit starts the dialling sequence and sends message C.
- ABORT / D:** If the SD1+ is programmed as "ABORT by INPUT" this connection can be used to abort the dialling sequence. If the SD1+ is not programmed as "ABORT by INPUT" this connection can be used as trigger input D. **Trigger/Abort inputs can be selected to be either +ve applied to trigger or -ve applied to trigger. Set the "Trigger Polarity" jumper-link to the appropriate position.**
- 0V:** Connect to a permanent 0V supply on the AT-SD1+PSU (negative on the 12Vdc power unit).
- +12V:** Connect to a permanent +12V supply on the control panel AT-SD1+PSU (positive on the 12Vdc power unit).

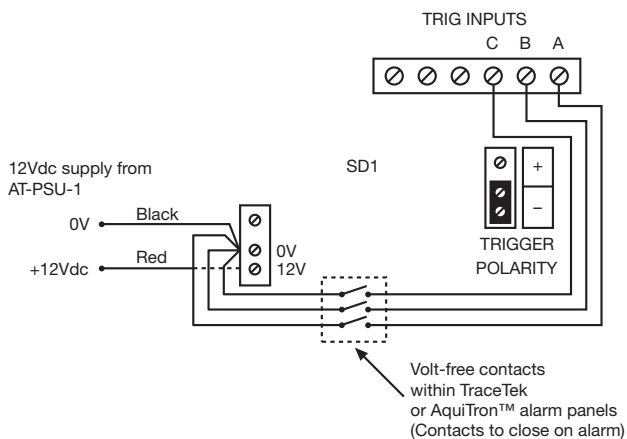

- Connections on the SD1+ are described as either "Safety Extra-Low Voltage" circuits (SELV) or "Telecommunication Network Voltages" circuits (TNV). Therefore it is important that installer ensures that TNV circuits are only connected to the PSTN and SELV circuits are only connected to other circuits designated as SELV circuits.
- Please ensure that cabling to the telephone line connections (TNV) are routed well away from the trigger input circuitry (SELV) and the cabling to the trigger input circuitry (SELV) are routed well away from the telephone circuitry (TNV).

6. Control Panel Connections

The table below shows the connection details to various control panels.

Control Panel	Connections
TTDM-PLUS	Leak Fault Service
TTSIM-1A	Leak/fault
AT-SZA	Leak Fault/Cable break
AT-MZA	Leak Fault/Cable break
AT-DIM	Leak and cable break
Other devises	Contacts to close on alarm

7. BT. Connections

1. Connect telephone line using one of the methods shown below:
2. Replace the plastic cover over the telephone line

Method 1 - Using the lead supplied

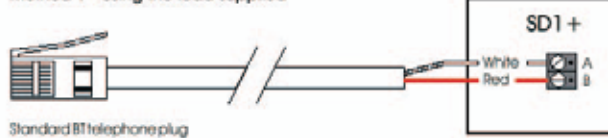

Method 2 - Hard wired connections

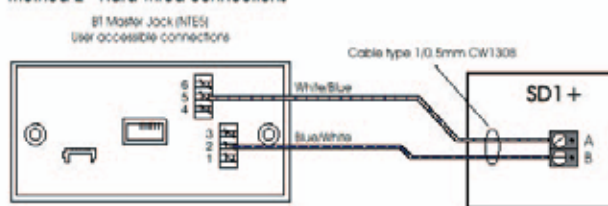

8. Commissioning and Testing

1. If the SD1+ is not being used in the UK please ensure the options switch is set to the appropriate settings, see section 9.
2. Hold the blade of a small screwdriver between the "Factory Restart" pins (JP2) and switch the power back on.
3. Remove the screwdriver blade and clip the SD1+ front cover onto the base taking care not to trap any cables.
4. The SD1+ "beeps" every 30 seconds and the display shows: **PLEASE RECORD**
5. To select the programming mode enter the default pass code of 1234 connections.
6. The display will show: **READY**

The unit is now ready for programming and testing. Please refer to the "Operating Instructions" for full details.

9. Option Switch Settings

The SD1+ may be fitted with a 4-way option bit switch, this allows the SD1+ to be configured for different countries.

SW1	SW2	SW3	SW4	Mode	Telecommunications
Off	Off	Off	Off	Security	UK & Ireland
On	Off	Off	Off	Security	Belgium
Off	On	Off	Off	Security	Netherlands & Norway
On	On	Off	Off	Security	Not Used
Off	Off	On	Off	Security	Not Used
On	Off	On	Off	Security	Not Used
Off	On	On	Off	Security	TBR21 & Finland
On	On	On	Off	Security	Not Used



10. Specifications

Power input: 11.5 - 14Vdc
Current consumption: 35mA (standby); 70mA (Active)
Trigger inputs: A, B, C,D, input voltage 5 - 28V
Phrases A,B,C,D,O: 40 seconds \pm 2 seconds, sampled at 8KHz
Telephone Numbers: 4 x 24 digit telephone numbers
Case dimensions: 150(L) x 104(H) x 30(D) mm
REN value: 0

11. Approval

This product is manufactured to meet all European Economic Area telecommunication networks requirements.

The equipment has been approved in accordance with Council Decision 98/482/EC for pan-European single terminal connection to the public switched telephone network (PSTN). However, due to differences between the individual PSTNs provided in different countries, the approval does not, of itself, give an unconditional assurance of successful operation on every PSTN network termination point.

In the event of problems you should contact your equipment supplier in the first instance.

Electromagnetic compatibility

 and EMC

12. Troubleshooting Guide

Problem	The unit will not dial out.
Cause	Number incorrectly dialled
Action	Check the telephone number you are calling has been entered correctly.
Cause	If the SD1+ is connected to a PABX system you may require a pause after dialling the first digit.
Action	Program a pause in the telephone number (see "Operating Instructions"). If this does not solve the problem the SD1+ must be connected to a direct telephone line.
Cause	Incorrect telephone line connections.
Action	Check the connections to the telephone line (see section 7).
Problem	When the unit calls the recipient they can't acknowledge the unit by pressing the number [8] button.
Cause	Incorrect acknowledgement procedure.
Action	Instruct the recipient in the correct procedure (see Operating Instructions).
Cause	Incorrectly connected to the telephone socket.
Action	Check that all three connections are correctly connected (see section 7).
Cause	Incompatible telephone.
Action	Call the recipient and ask them to press the number [8] button on their telephone for 1 second. If you hear anything other than a 1 second tone, their telephone is not capable of acknowledging the SD1+.
Problem	The recipient can't acknowledge the unit with a mobile telephone.
Cause	Weak reception or incompatible telephone.
Action	Mobile telephones will only work correctly if they are used in an area where the reception is good.

Important: All information, including illustrations, is believed to be reliable. Users, however, should independently evaluate the suitability of each product for their application. Aquilar Limited makes no warranty as to the accuracy or completeness of the information, and disclaims any liability regarding its use. The only obligations of Aquilar Limited are those in the Aquilar Standard Terms and Conditions of Sale for this product, and in no case will Aquilar Limited be liable for any incidental, indirect, or consequential damages arising from the sale, resale, use or misuse of the product. Specifications are subject to change without notice. In addition, Aquilar Limited reserves the right to make changes - without notification to Buyer - to processing or materials that do not affect compliance with any applicable specification.

AquiTron is a trademark of AquiTron Limited
Aquilar is a trademark of Aquilar Limited
TraceTek is a trademark of Tyco Thermal Controls

Aquilar Limited
Weights & Measures House, 20 Barttelot Road,
Horsham, West Sussex RH12 1DQ. UK
Tel: + 44 (0) 1403 216 100
Fax: +44 (0) 8707 940 320

E-mail: info@aquilar.co.uk
www.aquilar.co.uk

Master TraceTek Distributor UK & Ireland for
Raychem® TraceTek®
Water, Fuel and Chemical Leak Detection