

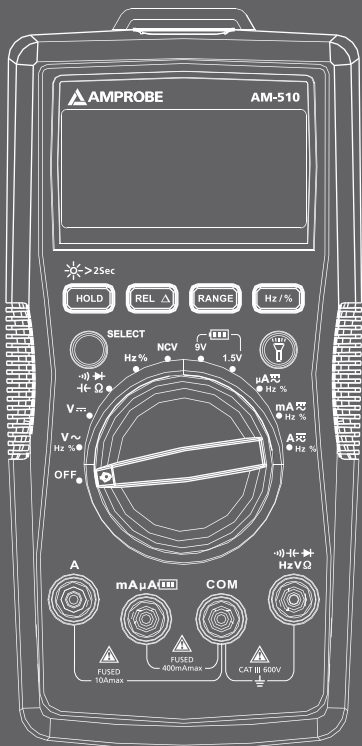

HARD AT WORK SINCE 1948.



AM-510 Commercial / Residential Multimeter

AM-510-EUR Digital Multimeter

Users Manual



AM-510

Commercial / Residential Multimeter

AM-510-EUR

Digital Multimeter

Users Manual

2/2012, Rev.2
©2012 Amprobe Test Tools.
All rights reserved. Printed in China

English

Limited Warranty and Limitation of Liability

Your Amprobe product will be free from defects in material and workmanship for one year from the date of purchase, unless local laws require otherwise. This warranty does not cover fuses, disposable batteries or damage from accident, neglect, misuse, alteration, contamination, or abnormal conditions of operation or handling. Resellers are not authorized to extend any other warranty on Amprobe's behalf. To obtain service during the warranty period, return the product with proof of purchase to an authorized Amprobe Service Center or to an Amprobe dealer or distributor. See Repair Section for details. THIS WARRANTY IS YOUR ONLY REMEDY. ALL OTHER WARRANTIES - WHETHER EXPRESS, IMPLIED OR STATUTORY - INCLUDING IMPLIED WARRANTIES OF FITNESS FOR A PARTICULAR PURPOSE OR MERCHANTABILITY, ARE HEREBY DISCLAIMED. MANUFACTURER SHALL NOT BE LIABLE FOR ANY SPECIAL, INDIRECT, INCIDENTAL OR CONSEQUENTIAL DAMAGES OR LOSSES, ARISING FROM ANY CAUSE OR THEORY. Since some states or countries do not allow the exclusion or limitation of an implied warranty or of incidental or consequential damages, this limitation of liability may not apply to you.

Repair

All test tools returned for warranty or non-warranty repair or for calibration should be accompanied by the following: your name, company's name, address, telephone number, and proof of purchase. Additionally, please include a brief description of the problem or the service requested and include the test leads with the meter. Non-warranty repair or replacement charges should be remitted in the form of a check, a money order, credit card with expiration date, or a purchase order made payable to Amprobe®.

In-Warranty Repairs and Replacement – All Countries

Please read the warranty statement and check your battery before requesting repair. During the warranty period any defective test tool can be returned to your Amprobe® distributor for an exchange for the same or like product. Please check the "Where to Buy" section on www.amprobe.com for a list of distributors near you. Additionally, in the United States and Canada In-Warranty repair and replacement units can also be sent to a Amprobe® Service Center (see address below).

Non-Warranty Repairs and Replacement – US and Canada

Non-warranty repairs in the United States and Canada should be sent to an Amprobe® Service Center. Call Amprobe® or inquire at your point of purchase for current repair and replacement rates.

In USA:

Amprobe

Everett, WA 98203

Tel: 877-AMPROBE (267-7623)

In Canada:

Amprobe

Mississauga, ON L4Z 1X9

Tel: 905-890-7600

Non-Warranty Repairs and Replacement – Europe

European non-warranty units can be replaced by your Amprobe® distributor for a nominal charge. Please check the "Where to Buy" section on www.amprobe.com for a list of distributors near you.

European Correspondence Address*

Amprobe® Europe

Beha-Amprobe GmbH

In den Engematten 14

79286 Glotttetal, Germany

Tel.: +49 (0) 7684 8009 - 0

www.beha-amprobe.com

*(Correspondence only – no repair or replacement available from this address. European customers please contact your distributor.)

AM-510 Commercial / Residential Multimeter

AM-510-EUR Digital Multimeter

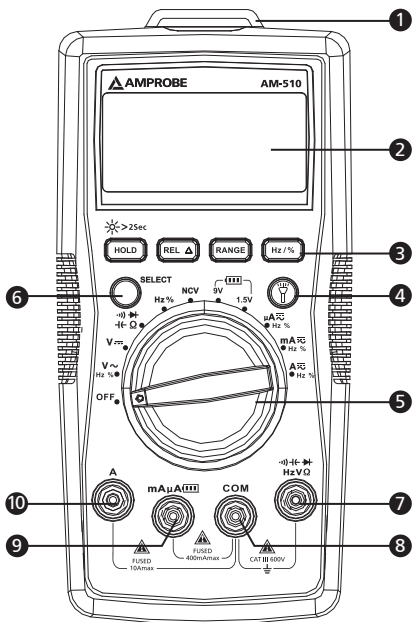

- ① Flash light
- ② LCD Display
- ③ Function Buttons
- ④ Flash light Button
- ⑤ Rotary Switch
- ⑥ SELECT Button
- ⑦ Input Terminal for voltage, frequency, diode, capacitance, resistance and continuity measurement
- ⑧ COM (return) terminal for all measurements
- ⑨ Input Terminal for battery test and AC/DC mA or μ A measurement
- ⑩ Input Terminal for AC/DC A measurement to 10A

Screen Display

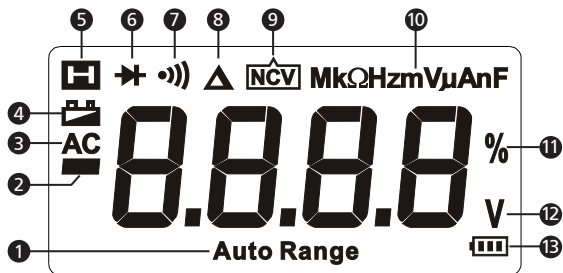

- 1** The Meter selects the range with best resolution
- 2** Negative reading
- 3** Alternate Current
- 4** Low battery indicator
- 5** Data hold
- 6** Diode test
- 7** Continuity test
- 8** Relative zero mode
- 9** Non-Contact Voltage
- 10** Measurement units
- 11** Duty Cycle
- 12** Measurement unit for voltage
- 13** Battery Test













AM-510 Commercial / Residential Multimeter

AM-510-EUR Digital Multimeter

CONTENTS

SYMBOL	2
SAFETY INFORMATION	2
UNPACKING AND INSPECTION	3
FEATURES	4
MAKING MEASUREMENT	5
Measuring AC and DC Voltage.....	6
Measuring AC and DC Current.....	7
Measuring Resistance	8
Measuring Continuity	9
Measuring Diode.....	9
Measuring Capacitance	10
Measuring Frequency	10
Non-Contact Voltage Sensing	11
Battery Test.....	12
SPECIFICATION	12
MAINTENANCE	17
BATTERY AND FUSE REPLACEMENT	18

SYMBOLS

	Caution ! Risk of electric shock.
	Caution! Refer to the explanation in this Manual
	Alternating Current (AC)
	Direct Current (DC)
	The equipment is protected by double insulation or reinforced insulation
	Earth (Ground)
	Audible tone
	Battery
	Complies with European Directives
	Conforms to relevant Australian standards
	Canadian Standards Association (NRTL/C)
	Do not dispose of this product as unsorted municipal waste. Contact a qualified recycler.

SAFETY INFORMATION

The Meter complies with:

IEC/EN 61010-1 3rd Edition, UL61010-1 2nd Ed. and CAN/CSA C22.2 No. 61010.1-0.92 to Category III 600 Volts, Pollution degree 2

IEC/EN 61010-2-030

IEC/EN 61010-2-31 for test leads

EMC IEC/EN 61326-1

Measurement Category III (CAT III) is for measurements performed in the building installation. Examples are measurements on distribution boards, circuit-breakers, wiring, including cables, bus-bars, junction boxes, switches, socket-outlets in the fixed installation, and equipment for industrial use and some other equipment, for example, stationary motors with permanent connection to the fixed installation.

CENELEC Directives

The instruments conform to CENELEC Low-voltage directive 2006/95/EC and Electromagnetic compatibility directive 2004/108/EC

Warning: Read Before Using

- *To avoid possible electrical shock or personal injury, follow these instructions and use the Meter only as specified in this manual.*
- *Do not use the Meter or test leads if they appear damaged, or if the Meter is not operating properly. If in doubt, have the Meter serviced.*
- *Always use the proper function and range for measurements.*
- *Before rotating the function range selection switch, disconnect test probe from circuit under test.*
- *Verify the Meter's operation by measuring on a known voltage source.*
- *Do not apply more than the rated voltage, as marked on the Meter, between the test probe or between any test probe and earth ground.*
- *Use the Meter with caution for voltages above 30 Vac rms, 42 Vac peak, or 60 Vdc. These voltages pose electrical shock hazards.*
- *Disconnect circuit power and discharge all high-voltage capacitors before testing resistance.*
- *Do not use the Meter around explosive gas or vapor.*
- *When using the test leads, keep your fingers behind the finger guards.*
- *Remove test leads from the Meter before opening the Meter case or battery door.*

UNPACKING AND INSPECTION

Your shipping carton should include:

- 1 AM-510 or AM-510-EUR Multimeter
- 1 Pair of test leads
- 1 9V (6F22) battery (installed)
- 1 Users manual

If any of the items are damaged or missing, return the complete package to the place of purchase for an exchange.

FEATURES

The digital multimeter designed for advanced residential applications. Rewire an electrical panel, install heated floors or new light fixtures, troubleshoot and repair home appliances, electrical sockets and automotive electrical problems with this easy-to-use multimeter. The AM-510 / AM-510-EUR features a built-in flashlight to see wires in the dark, a kick stand, and probe holder to give you the "third-hand" you need while taking measurements and non-contact voltage detection for quick go-no-go checks without the need for an additional tool. Compact yet tough, this multimeter is built to last through all your electrical projects.

- Measurements: Voltage up to 600V AC/DC, AC/DC Current and Resistance
- Frequency, Capacitance, Duty Cycle for troubleshooting applications
- Special Functions:
 - Non-contact Voltage Detection
 - Audible continuity
 - Diode Test
- Backlit LCD display
- Events:
 - Data hold
 - Relative zero mode
- Built in work light (flashlight)
- Built in test leads storage and "third hand" probe holder
- Auto and Manual ranging
- Auto power off
- Low battery warning
- Safety: CAT III 600V

MAKING MEASUREMENT



1. Use the proper function and range for measurements.
2. To avoid possible electrical shock, personal injury or damages to the Meter, disconnect circuit power and discharge all high-voltage capacitors before testing resistance and diode.
3. Connecting test leads:
 - Connect the common (COM) test lead to the circuit before connecting the live lead;
 - After measurement, remove live lead before removing the common (COM) test lead from the circuit
4. Symbol "OL" is displayed on LCD when the measurement is out of range.

Rotary Switch Positions

Switch Position	Measurement Function	
$V \overline{\sim}$	AC or DC voltage measurement (use SELECT button for switching to AC or DC).	
Ω	Resistance measurement	
$\rightarrow \dashv$	Voltage measurement of diode PN junction	
$\bullet \parallel$	Continuity measurement	
$\dashv \parallel$	Capacitance measurement	
Hz	Frequency measurement	
%	Duty cycle	
NCV	Non-contact voltage	
	9V	For measurement of dry batteries of not exceeding 15Vdc
	1.5V	For measurement of dry batteries of not exceeding 2Vdc
$\mu A \overline{\sim}$ mA $\overline{\sim}$ A $\overline{\sim}$	AC or DC current measurement (use SELECT button for switching to AC or DC).	

Rotary Switch Positions

Button	Measurement Function
SELECT	Press the yellow SELECT button to select alternate measurement functions on the rotary switch.

HOLD / ☀️ >2Sec	Display freezes present reading / press 2 sec to turn on LCD backlight.
REL Δ	Relative zero mode
RANGE	Manual or Auto range switching. The default setting is Auto ranging, press to switch to manual ranging (selectable resolutions). Press for 2 sec to return to auto ranging.
Hz / %	Frequency / Duty Cycle. Press to turn on Frequency measurement mode; press again for duty cycle measurement.
🔊	Flash light

Press  to enable the function when at relevant rotary switch function.

Auto Power OFF

Auto power off: approx. 30 minutes.

When the Meter is in auto power off mode, press any button to resume normal operation.

Measuring AC and DC Voltage

⚠️ ⚠️ To avoid personal injury or damage to the Meter, do not apply voltage higher than 600V.

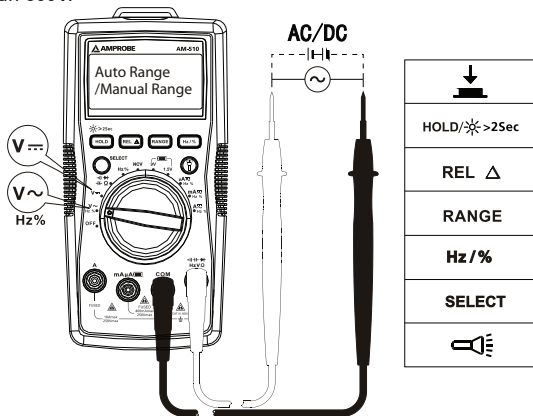

Measuring AC and DC Current

Press SELECT button to select AC or DC current measurement function.

⚠ ⚠ To avoid personal injury or damage to the Meter:

1. Do not attempt to make an in-circuit current measurement when the open-circuit potential to earth ground exceeding 600V.
2. Switch to proper function and range for your measurement.
3. Do not place the test probe in parallel with a circuit when the test leads are connected to the current terminals.
4. Connect the test leads to the correct input A/mA μ A current terminal and to the circuit before powering the circuit under test.
5. For current range from 8-10A, do not measure current for more than 20 minutes. Wait for 10 minutes before taking another measurement
6. After measurement, switching OFF the circuit's power before removing test leads from the circuit.

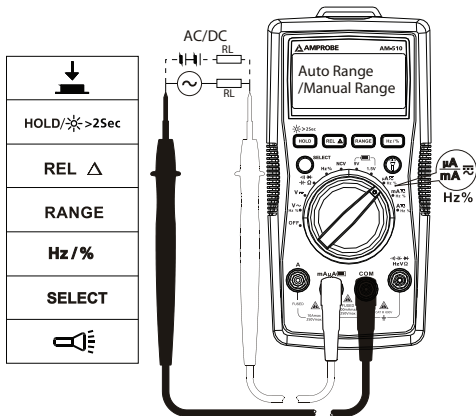

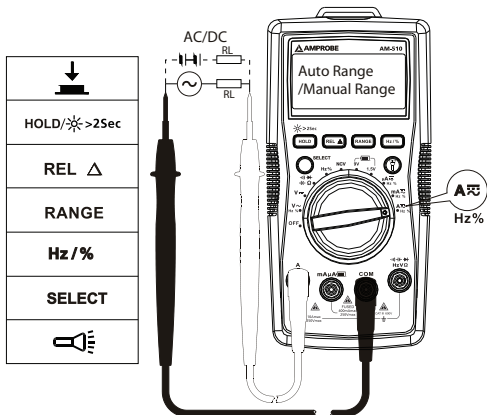

Measuring Resistance

⚠ ⚠ Disconnect circuit power and discharge all high-voltage capacitors before testing resistance.

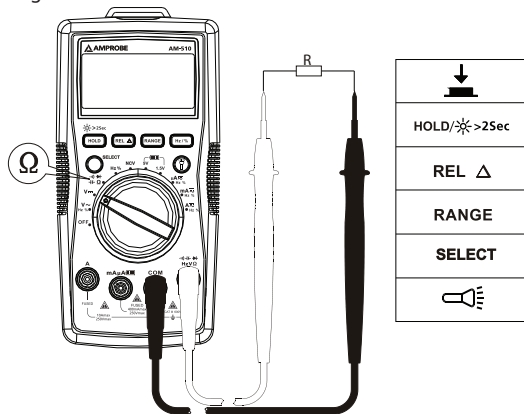

Note:

On a higher resistance measurement ($>1\text{M}\Omega$), the measurement may take a few seconds to get stable reading.

Over range or open circuit indication: OL

Measuring Continuity

⚠ ⚠ Disconnect circuit power and discharge all high-voltage capacitors before testing continuity.

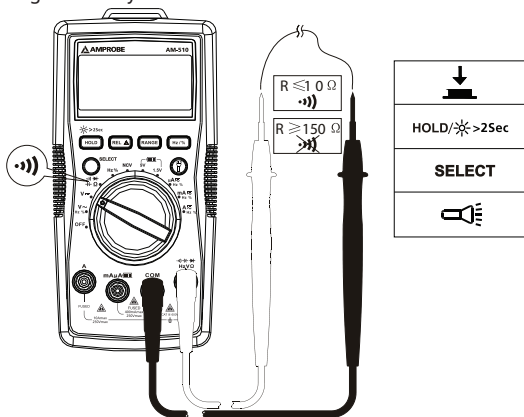

Measuring Diode

⚠ ⚠ Disconnect circuit power and discharge all high-voltage capacitors before testing diode.

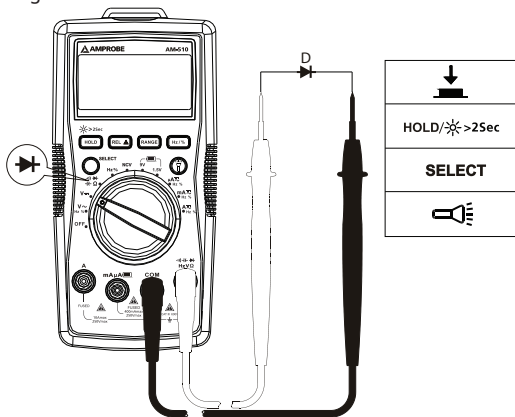

Measuring Capacitance

⚠ ⚠ Disconnect circuit power and discharge all high-voltage capacitors before testing capacitance.

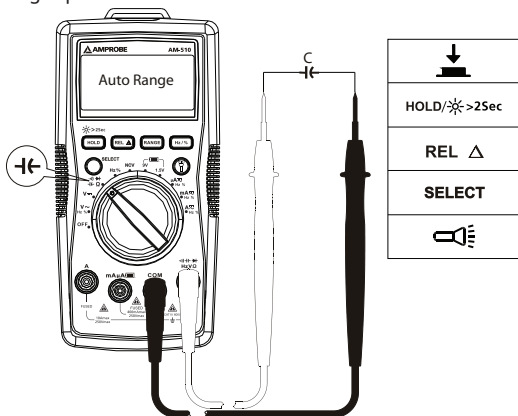

Measuring Frequency

Press Hz/% button to select Frequency / Duty Cycle measurement function.

⚠ ⚠ To avoid personal injury or damage to the Meter, do not apply voltage higher than 600V.

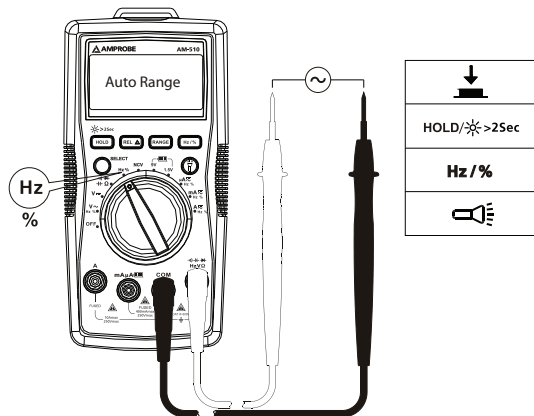

Non-Contact Voltage Sensing



1. To avoid personal injury or damage to the Meter, do not test on un-insulated high voltage wires.
2. Buzzer will sound when detecting voltage higher than AC 90V. Screen displays "OL".
3. Do not test on hazardous live wires higher than AC 600V.

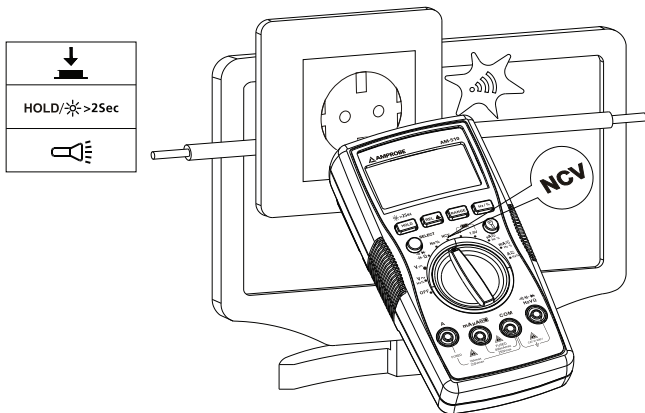

Battery Test

⚠ ⚠ Applying a voltage source or incorrect battery type under battery test may cause personal injury or damage to the Meter.

Battery 1.5V range is for dry battery not exceeding 2Vdc. The resistance load is around 30Ω.

Battery 9V range is for dry battery not exceeding 15Vdc. The resistance load is around 1KΩ.

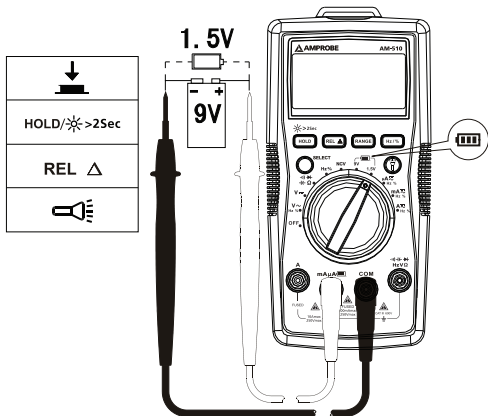

SPECIFICATION

Ambient temperature: 23°C ±5°C (73.4°F ±9°F)

Relative temperature: ≤75%

Accuracy: ±(% of reading + digits)

Maximum voltage between input terminal and earth ground: AC 600Vrms or DC 600V

⚠ Fuse for mA μA input: 0.5A H 660V fast-fuse, Φ6.3×32mm (AM-510)
0.5A H 700V fast-fuse, Φ6.3×32mm (AM-510-EUR)

⚠ Fuse for 10A input: 10A H 660V fast-fuse, Φ6.3×32mm. (AM-510)
10A H 600V fast-fuse, Φ6.3×25mm. (AM-510-EUR)

Maximum display: Digital 3999 counts, updates 3/sec. Frequency: 4999 counts.

Over-range indication: OL

Range: Automatic

Altitude: Operating $\leq 2000\text{m}$

Operating temperature: $0^{\circ}\text{C} \sim +40^{\circ}\text{C}$ ($32^{\circ}\text{F} \sim 104^{\circ}\text{F}$)

Relative humidity: $0^{\circ}\text{C} \sim +30^{\circ}\text{C}$ ($32^{\circ}\text{F} \sim 86^{\circ}\text{F}$) $\leq 75\%$; $+30^{\circ}\text{C} \sim +40^{\circ}\text{C}$ ($86^{\circ}\text{F} \sim 104^{\circ}\text{F}$) $\leq 50\%$

Storage temperature: $-10^{\circ}\text{C} \sim +50^{\circ}\text{C}$ ($14^{\circ}\text{F} \sim 122^{\circ}\text{F}$)

Electromagnetic compatibility: In an RF field of $1\text{V/m} = \text{Specified accuracy} \pm 5\%$

Battery: 9V, 6F22, NEDA1604 or equivalent

Low battery indication: 

Dimensions (L x W x H): 182 mm x 90 mm x 45 mm (7.2 in x 3.5 in x 1.8 in)

Weight: Approx. 354g (0.78lb) with batteries installed

1. DC Voltage Measurement

Range	Resolution	Accuracy
4.000V	1mV	$\pm(0.8\%+1\text{dgt})$
40.00V	10mV	
400.0V	100mV	
600V	1V	$\pm(1.0\%+3\text{dgt})$

Input impedance: around $10\text{M}\Omega$; (Input impedance $> 3\text{G}\Omega$ for DC 400mV range)

Overload protection: $\pm 600\text{V}$

2. AC Voltage Measurement

Range	Resolution	Accuracy
400.0mV	0.1mV	$\pm(1.2\%+3\text{dgt})$
4.000V	1mV	$\pm(1.0\%+3\text{dgt})$
40.00V	10mV	
400.0V	100mV	
600V	1V	$\pm(1.2\%+3\text{dgt})$

Note: 400.0mV range is available for manual range only.

Input impedance: around $10\text{M}\Omega$

Frequency response: 45Hz \sim 400Hz

Average sensing, rms indication.

Overload protection: 600Vrms

3. Resistance Measurement



Range	Resolution	Accuracy
400.0Ω	0.1Ω	±(1.2%+2dgt)
4.000kΩ	1Ω	±(1.0%+2dgt)
40.00kΩ	10Ω	
400.0kΩ	100Ω	
4.000MΩ	1kΩ	±(1.2%+2dgt)
40.00MΩ	10kΩ	±(1.5%+5dgt)

400Ω range: Measured value = (Measured display value) – (Short-circuiting value of probe)

Open circuit voltage: around 0.5V

Overload protection: 600Vrms

4. : Continuity : Diode measurement

Range	Resolution	Accuracy
	0.1Ω	Open circuit voltage is around 0.5V. Resistance >150Ω, buzzer will not sound. Resistance ≤10Ω, buzzer will sound.
	1mV	Open-circuit voltage is around 1.5V. Normal voltage is around 0.5V to 0.8V for silicon PN junction.

Overload protection: 600Vrms

5. Capacitance Measurement

Range	Resolution	Accuracy
40.00nF	10pF	±(3%+10dgt) under REL status
400.0nF	100pF	±(3%+5dgt) under REL status
4.000uF	1nF	
40.00uF	10nF	±(3%+5dgt)
100.0uF	100nF	±(4%+5dgt)

Overload protection: 600Vrms

6. Measurement of frequency/duty cycle

Range	Resolution	Accuracy
10Hz~10MHz	0.01Hz~0.01MHz	$\pm(0.1\%+4\text{dgt})$
0.1%~99.9%	0.1%	--

Overload protection: 600V_{rm}

Input amplitude: (DC level is 0.)

10Hz~1MHz: $300\text{mV} \leq a \leq 30\text{V}_{\text{rms}}$

>1MHz~10MHz: $600\text{mV} \leq a \leq 30\text{V}_{\text{rms}}$

Input amplitude and frequency response must meet following conditions when reading frequency or duty cycle during AC voltage or current measurement

- Input amplitude \geq Range \times 30%
- Frequency response: $\leq 400\text{Hz}$

7. Battery Test

Range	Internal load resistance	Accuracy
1.5V	About 30 Ω	$\pm(1.0\%+3\text{dgt})$
9V	About 1k Ω	

Overload protection:

 F1 0.5A H 660V fast-fuse, $\Phi 6.3 \times 32\text{mm}$ (AM-510)

F1 0.5A H 700V fast-fuse, $\Phi 6.3 \times 32\text{mm}$ (AM-510-EUR)

For 1.5V range: Load resistance is around 30 Ω .

For 9V range: Load resistance is around 1k Ω

8. DC Current Measurement

Range		Resolution	Accuracy
μA	400.0 μA	0.1 μA	$\pm(1.0\%+2\text{dgt})$
	4000 μA	1 μA	
mA	40.00mA	10 μA	
	400.0mA	0.1mA	
A	4.000A	1mA	$\pm(1.2\%+3\text{dgt})$
	10.00A	10mA	

Overload protection:



mA / μ A input:

F1 fuse, 0.5A H 660V fast-fuse, Φ 6.3 \times 32mm (AM-510)

F1 fuse, 0.5A H 700V fast-fuse, Φ 6.3 \times 32mm (AM-510-EUR)

10 A input:

F2 fuse, 10A H 660V fast-fuse, Φ 6.3 \times 32mm. (AM-510)

F2 fuse, 10A H 600V fast-fuse, Φ 6.3 \times 25mm. (AM-510-EUR)

9. AC Current Measurement

	Range	Resolution	Accuracy
μ A	400.0 μ A	0.1 μ A	$\pm(1.2\%+2\text{dgt})$
	4000 μ A	1 μ A	
mA	40.00mA	10 μ A	
	400.0mA	0.1mA	
A	4.000A	1mA	$\pm(1.5\%+3\text{dgt})$
	10.00A	10mA	

Frequency response: 45Hz ~ 400Hz

Average sensing, rms indication

Overload protection:



mA / μ A input:

F1 fuse, 0.5A H 660V fast-fuse, Φ 6.3 \times 32mm (AM-510)

F1 fuse, 0.5A H 700V fast-fuse, Φ 6.3 \times 32mm (AM-510-EUR)

10 A input:

F2 fuse, 10A H 660V fast-fuse, Φ 6.3 \times 32mm. (AM-510)

F2 fuse, 10A H 600V fast-fuse, Φ 6.3 \times 25mm. (AM-510-EUR)

MAINTENANCE AND REPAIR

If the Meter fails to operate, check battery, test leads, etc., and replace as necessary.

Double check the followings:

1. Replace the fuse or battery if the meter does not work.
2. Review the operating instructions for possible mistakes in operating procedure.

Quick check on 0.5A FUSE:

Step 1: Turn the rotary switch to Ω function.

Step 2: Connect test lead to ∇ /V/ Ω /Hz terminal and mA/ μ A terminal.

Resistance reading $\leq 10M\Omega$: the fuse is OK

Resistance reading "OL": the fuse is open. Replace the fuse as specified.

Quick check on 10A FUSE:

Step 1: Turn the rotary switch to Ω function.

Step 2: Connect test lead to ∇ /V/ Ω /Hz terminal and mA/ μ A terminal.

Resistance reading $\leq 0.5\Omega$: the fuse is OK.

Resistance reading "OL": the fuse is open. Replace the fuse as specified.

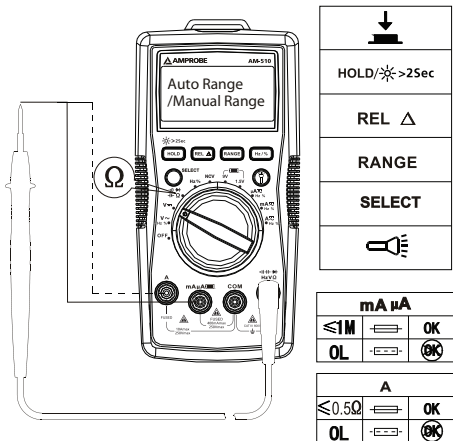

Except for the replacement of the battery, repair of the meter should be performed only by a Factory Authorized Service Center or by other qualified instrument service personnel.

The front panel and case can be cleaned with a mild solution of detergent and water. Apply sparingly with a soft cloth and allow to dry completely before using. Do not use aromatic hydrocarbons, Gasoline or chlorinated solvents for cleaning.

BATTERY AND FUSE REPLACEMENT

WARNING

To avoid shock, injury, or damage to the Meter:

Disconnect test leads before opening case.

Use ONLY fuses with the amperage, interrupt, voltage, and speed ratings specified.

Replacing BATTERY follow below steps:

1. Disconnect the test lead probe from measuring circuit.
2. Turn the Meter to OFF position.
3. Remove the screws from the battery cover and open the battery cover
4. Remove the batteries and replace with one 9V (6F22) or equivalent. The battery cover provides the correct polarity fitting construction design. Install the battery in the battery cover.
5. Put the battery cover back and re-fasten the screw.

Battery: 9V (6F22) Battery or equivalent

Replacing FUSE follow below steps:

1. Disconnect the test lead probe from measuring circuit.
2. Turn the Meter to OFF position.
3. Remove the screws from the enclosure and open the enclosure.
4. Remove the broken fuse and replace with new specified fuse.
5. Put the enclosure back and re-fasten the screw.

Fuse ratings:

mA / μ A input terminal:

F1 fuse, 0.5A H 660V fast-fuse, Φ 6.3x32mm (AM-510)

F1 fuse, 0.5A H 700V fast-fuse, Φ 6.3x32mm (AM-510-EUR)

10 A input terminal:

F2 fuse, 10A H 660V fast-fuse, $\Phi 6.3 \times 32\text{mm}$. (AM-510)

F2 fuse, 10A H 600V fast-fuse, $\Phi 6.3 \times 25\text{mm}$. (AM-510-EUR)

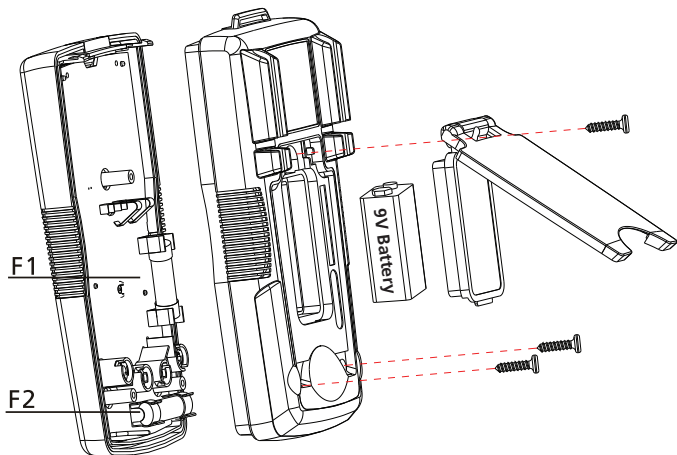

Visit www.Amprobe.com for

- **Catalog**
- **Application notes**
- **Product specifications**
- **User manuals**

Amprobe®

www.Amprobe.com

info@amprobe.com

Everett, WA 98203

Tel: 877-AMPROBE (267-7623)

Amprobe® Europe

Beha-Amprobe

In den Engematten 14

79286 Glottertal, Germany

Tel.: +49 (0) 7684 8009 - 0



Please
Recycle